



**PUMP COMPANY**

*Zoeller Family of Water Solutions™*

# *Pumps and Systems*

Utility, Pedestal

Sump, Effluent, Dewatering

Sewage Pumps

Grinder Pumps and Systems

Specialty Products



*Your Peace of Mind is Our Top Priority®*

## WHAT SETS ZOELLER PUMPS APART?

Since 1939, Zoeller Company has been manufacturing water pumps of many types. From pedestal pumps in the beginning to large HP, submersible, non-clog pumps in recent years, we have gained invaluable manufacturing experience from our humble beginning in August Zoeller's basement workshop.

Over the years, one of our most important mottos has been, 'We excel at 1,000 little things'. From start to finish, we take pride in our products. When you have residential or commercial wastewater issues, you can count on Zoeller to deliver the very best solutions. Our commitment to unsurpassed quality offers years of service and durability with a responsive and knowledgeable product support team just a phone call away.

- **MANUFACTURING IS IN OUR BLOOD...**

Rather than using a 'puzzle piece' mentality and simply buying components from other sources and assembling them, we manufacture most of our products from start to finish, continually checking the quality throughout the entire process.

Quality is always the most important element at Zoeller. Above all, quality is what has made us successful and continues to drive the decisions we make. A quality product cannot be manufactured with low-grade components. By bringing in high-quality raw castings as well as machining and powder coating the pieces in house, we are able to control the quality of each part and identify any defect throughout the manufacturing process. Each piece is subjected to numerous quality checkpoints along the way to guarantee that it is the best of the best.

- **FACTORY TESTING IS NOT JUST A BUZZWORD...**

Instead of running 'audits' on a calculated number of pumps, all submersible Zoeller pumps are 100% factory tested underwater prior to shipment. Each pump is subjected to a leak test to ensure that all gaskets, seals and mating surfaces will hold under pressure. After the pressurized leak test, the pump is powered up and run underwater to ensure that it is capable of the published head capacity and flow rate listed in our catalog and specification sheets. This testing allows us to guarantee the pump will operate out of the box every time, and you can rest assured that YOUR Zoeller pump was tested underwater for both electrical and hydraulic performance.

- **FULL BREADTH OF PRODUCT LINE...**

Zoeller is your 'one stop shop' when dealing with dewatering and wastewater systems. We offer everything from a small fractional sump pump to a large, 100 HP, non-clog pump. From battery back-ups, check valves, sewage grinder systems, small prepackaged residential units or large prepackaged municipal systems, Zoeller can offer it all. Next time you are looking for a water or wastewater system, reach for the only catalog you will ever need... Zoeller Company!

**Zoeller provides the best products at every price point. Look for these icons to be assured of the best choice for your specific project needs:**



### **PREMIUM**

Designed with the very best material and the latest technology.



### **PROFESSIONAL**

Zoeller time-proven quality. An industry fixture.



### **BUILDER**

Accessible quality for the cost conscious.



# 42, 44, 46

## Floor Sucker Series

Ideal for intermittent use, these pumps can draw water down as low as 1/8" (3 mm). To reduce maintenance and eliminate clogging, a screened bottom intake design is used. Motor life is enhanced and extended by an energy-efficient design and a UV-protected pump body. Pump discharge is fully adaptable to standard garden hose connections, and a handle is provided for ease of handling.



### APPLICATIONS:

- General water transfer
- Dewatering

### SPECIFICATIONS:

- 3/4" (19 mm) garden hose outlet
- Thermally protected motor
- LM44 is AUTOMATIC with no float switch
- Available with 9' or 20' (3 or 6 m) power cord
- Oil free (models 42, 44)
- Temperature rated 104 °F (40 °C)

For more information, see Technical Data Sheet FM2773.

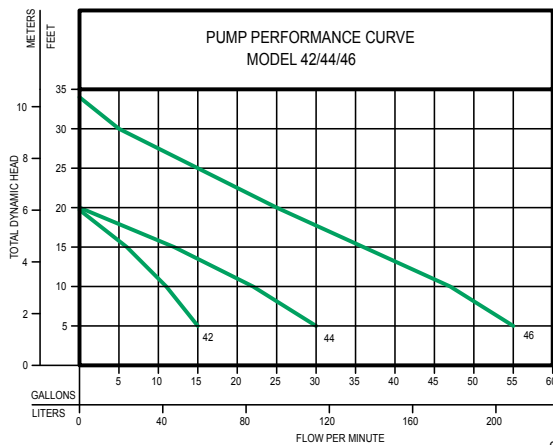

014066

# 311

## Mighty Mover

Ideal for intermittent use, this portable and lightweight transfer pump performs at a high level. This type of pump often experiences dry-run conditions, so the metal pump housing and nylon impeller (extra impeller included) can outperform similar products with plastic pump housings. It includes a suction hose and remote suction plate for added convenience.



UTILITY, PEDESTAL

### APPLICATIONS:

- General water transfer
- Draining water heaters
- Filling radiant heating lines

### SPECIFICATIONS:

- 3/4" (19 mm) garden hose inlet and outlet
- Includes 6' (2 m) suction hose and remote suction plate
- Available with 6' (2 m) power cord
- Temperature rated 130 °F (54 °C)

For more information, see Technical Data Sheet FM2774.

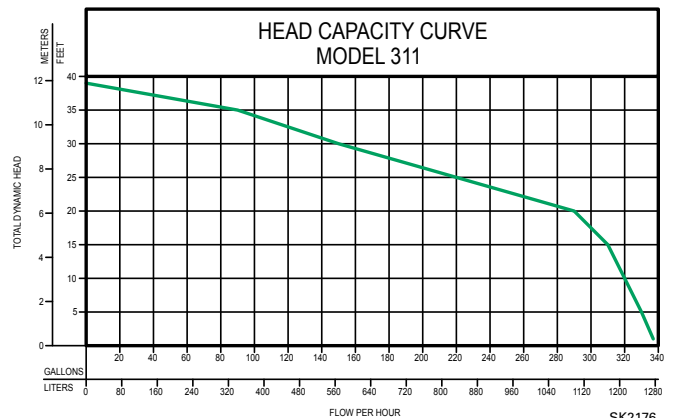

SK2176

# 314

## Water Mover

Generating almost 50 PSI, this is our most powerful transfer pump. The durable cast iron pump housing and easily serviced brush motor ensure trouble-free operation. For convenience, an over-sized priming handle is included, so no tools are required. The extra-long power cord and pump-mounted on-off switch simplify operation.



### APPLICATIONS:

- Water transfer
- Power washing
- Filling radiant heating lines

### SPECIFICATIONS:

- 3/4" NPT inlet and outlet with lead-free brass garden hose adapters
- Includes suction screen and extra set of brushes
- Available with 20' (6 m) power cord
- Temperature rated 120 °F (49 °C)

For more information, see Technical Data Sheet FM2775.

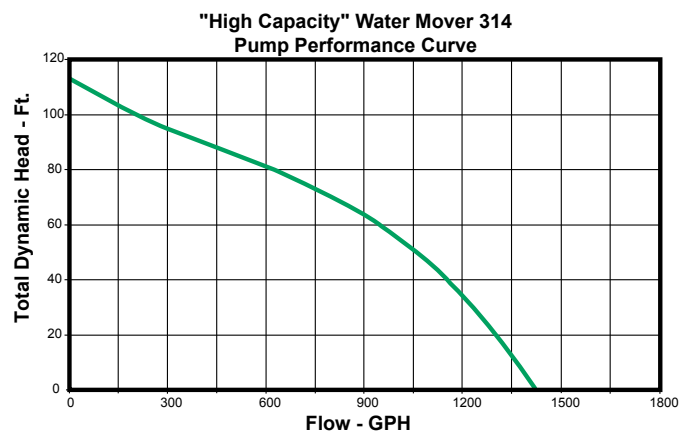

IL0153

# 81, 82, 84

## Old Faithful

Ideal for residential sump pits, these column pumps feature an above-pit cover motor design. An adjustable float allows the user to set the on and off points that best meet their needs. The permanently lubricated motor is thermally protected for quiet operation and longer life. The non-clogging vortex impeller and inlet screen help eliminate jamming from debris such as leaves and other small particles.



### APPLICATIONS:

- New sump and residential construction
- Sump pits

### SPECIFICATIONS:

- 1-1/2" or 1-1/4" NPT discharge
- Top inlet eliminates air-locked conditions
- Adjustable float
- 81/82 thermoplastic base, 84 cast iron base
- Temperature rated 130 °F (54 °C)

For more information, see Technical Data Sheet FM2776.

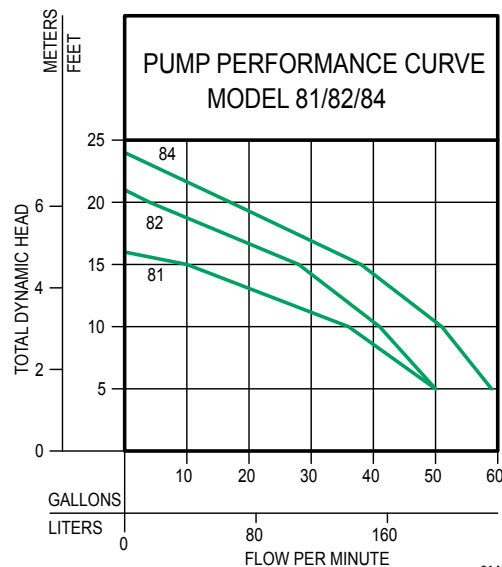

014569



49

# Water Ridd'r III

This compact, robust pump fits into smaller sump basins. The factory-set float switch is set to maximize pump range while ensuring no float hang-ups. The sturdy pump base keeps larger debris from clogging the pump and prevents the pump from moving around the pit.



**APPLICATIONS:**

- Residential sump
- New construction sump



**SPECIFICATIONS:**

- 1-1/2" NPT discharge
- Mercury-free mechanical float
- Available with 9' (3 m) power cord
- 3/8" (9 mm) solids passing

For more information, see Technical Data Sheet FM2777.

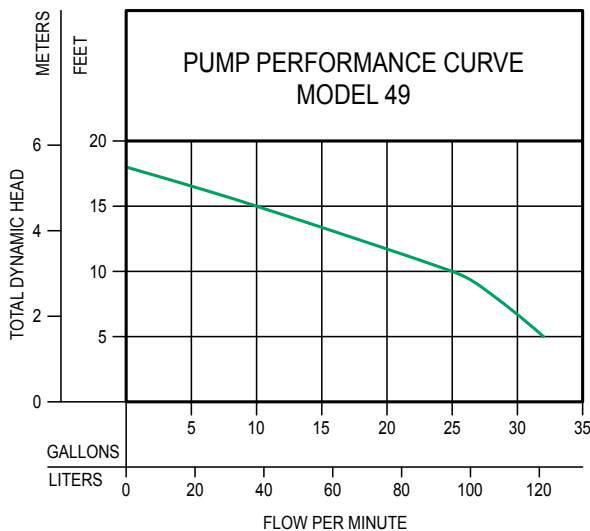

018141

73, 75

# Builder Series

The Models 73 and 75 offer accessible quality for the cost conscious. These submersible pumps are designed for use in residential or light commercial dewatering applications and can be used to transfer groundwater or effluent. The pump includes a cast iron motor housing with a corrosion-resistant, baked-on enamel finish and is designed to provide great heat dissipation from the motor, ensuring a long service life.



SUMP, EFFLUENT

**APPLICATIONS:**

- Water transfer
- Sump and dewatering systems
- New sump and residential construction

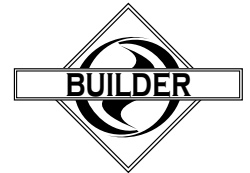

**SPECIFICATIONS:**

- 1/3 HP (Model 73) and 1/2 HP (Model 75)
- 1-1/2" NPT discharge
- Available in automatic operation only
- Thermally protected motor
- Available with 9' (3 m) power cord
- 3/8" (9 mm) solids passing

For more information, see Technical Data Sheets FM2897 and FM2849.

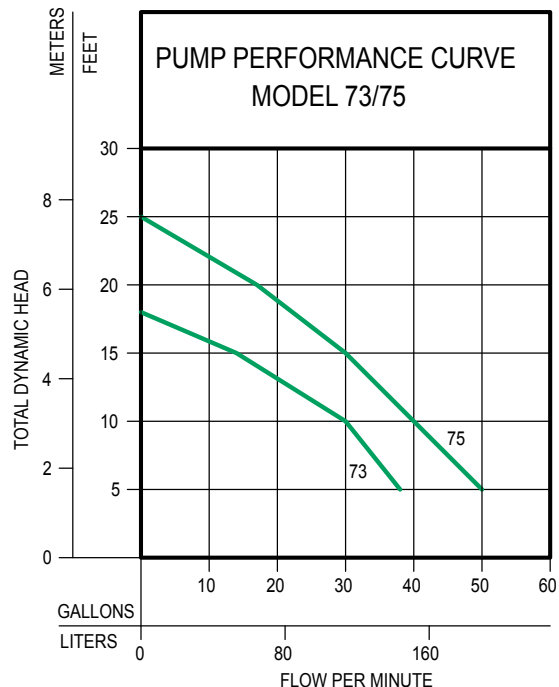

013980

# 53, 55, 57, 59, 98

## Mighty-Mate/Flow-Mate

Considered one of America's most popular sump pumps. This robust family of sump pumps is known for reliability, durability and performance. The preset, integral snap-action float switch is engineered for one million mechanical starts. The heat-dissipating cast iron body with powder coated epoxy finish provides maximum pumping performance under the most extreme conditions. With Zoeller's cool run design, the hermetically sealed, oil-filled motor and non-clogging vortex impeller add up to a long-lasting, trouble-free product.



SUMP, EFFLUENT



### APPLICATIONS:

- Water transfer
- Sump and effluent systems
- Light commercial
- New sump and residential construction

### SPECIFICATIONS:

- 1-1/2" NPT discharge
- 3/10 HP (53, 55, 57, 59), 1/2 HP (98)
- Available in automatic or nonautomatic
- 1/2" (12 mm) spherical solids capacity
- Thermoplastic or cast iron base
- Thermoplastic or cast iron impeller
- Bronze construction available (55/59 series)

For more information, see Technical Data Sheets FM2778, FM2779.



Nonautomatic model with piggyback

### OPTIONAL\* PUMP STAND P/N 10-2421

- Reduces potential clogging by debris
- Replaces rocks or bricks under the pump
- Made of durable, non-corrosive ABS
- Raises pump 2" (5 cm) off bottom of basin
- Provides the ability to raise intake by adding sections of 1-1/2" or 2" (DN40 or DN50) PVC piping
- Attaches securely to pump
- Accommodates sump, dewatering and effluent applications

NOTE: Make sure float is free from obstruction.

\*Fits series 49, 50, 63, 70, 95, 98, 130, 140 and 150.

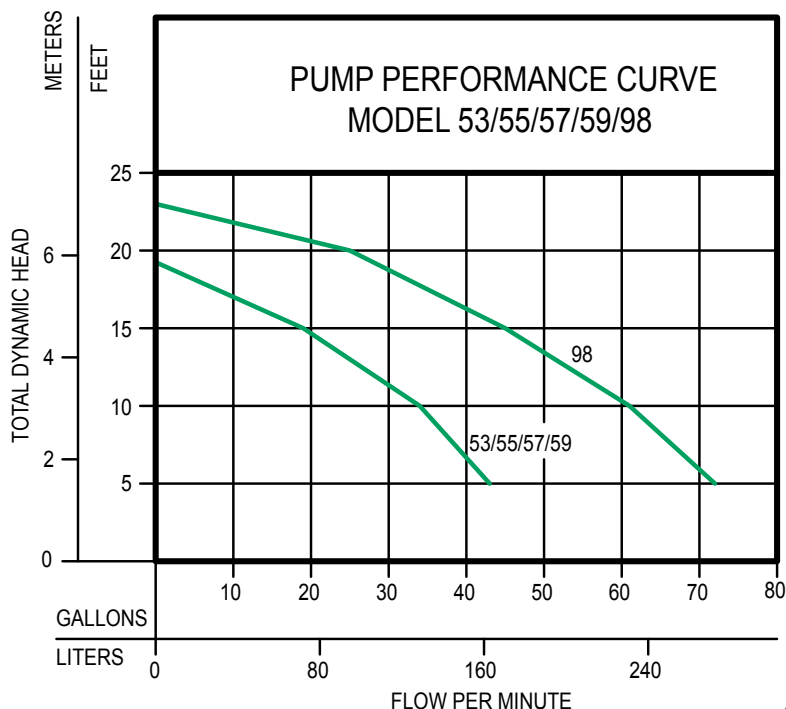
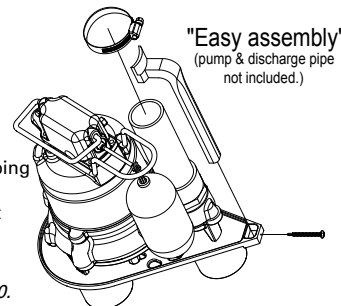

152655

# 63

## Premium Series

These Premium sump pumps are designed with the very best materials and latest technology. Based on the 50 series sump pump, considered one of America's most popular sump pumps, this product offers advanced switch technology allowing longer switch life.



This model is constructed of the same heat-dissipating cast iron with powder coated epoxy finish, providing maximum pumping performance under the most extreme conditions. With Zoeller's cool run design, the hermetically-sealed, oil-filled motor and non-clogging vortex impeller add up to a long-lasting, trouble-free product. The heavy-duty power cord also includes an LED lighted plug.



### APPLICATIONS:

- Water transfer
- Sump systems
- Light commercial
- New sump and residential construction



### SPECIFICATIONS:

- 1-1/2" NPT discharge
- 3/10 HP
- 1/2" (12 mm) spherical solids capacity
- LED lighted plug
- Available in automatic operation only
- Advanced switch technology
- Viton switch arm boot and heavy-duty power cord
- Cast iron, non-clogging vortex impeller
- Cast iron base

For more information, see Technical Data Sheet FM2899.

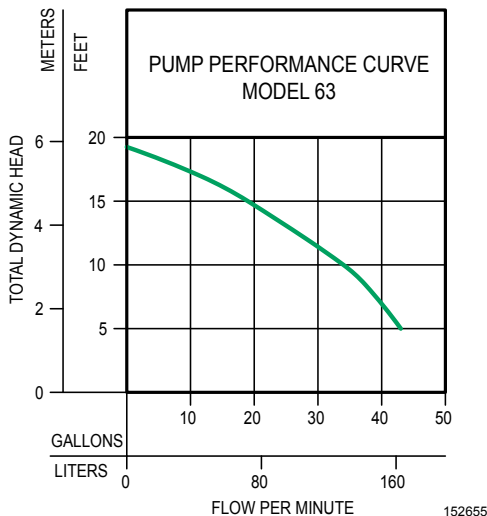

# 95

## Premium Series

The Model 95 Premium sump pump is designed with the very best materials and the latest technology. Based on the 98 sump pump, one of America's most popular sump pumps, this product offers advanced switch technology ensuring longer switch life. The Premium sump pump also provides 10% higher performance (GPM and TDH) over the Model 98.



This model is constructed of the same heat-dissipating cast iron with powder coated epoxy finish, providing maximum pumping performance under the most extreme conditions. With Zoeller's cool run design, the hermetically-sealed, oil-filled motor and non-clogging vortex impeller add up to a long-lasting, trouble-free product. The heavy-duty power cord also includes an LED lighted plug.



### APPLICATIONS:

- Water transfer
- Sump systems
- Light commercial
- New sump and residential construction



### SPECIFICATIONS:

- 1-1/2" NPT discharge
- 1/2 HP
- 1/2" (12 mm) spherical solids capacity
- LED lighted plug
- Available in automatic operation only
- Advanced switch technology
- Viton switch arm boot and heavy-duty power cord
- Non-clogging vortex impeller
- Cast iron base

For more information, see Technical Data Sheet FM2985.

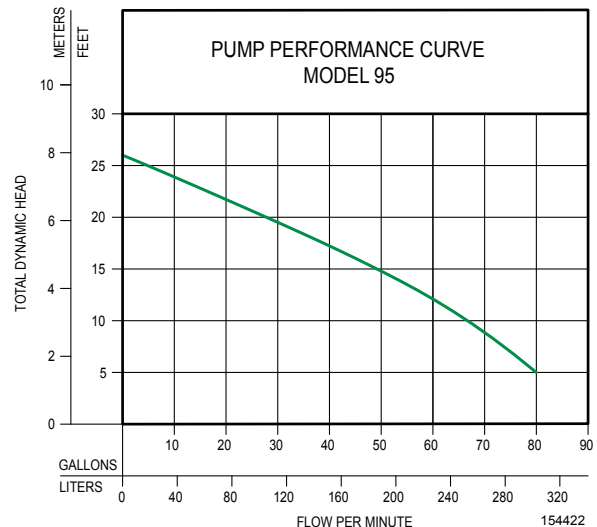

SUMP EFFLUENT

# 137, 139, 140, 145

## Flow-Mate

In high head dewatering or effluent applications where pumping performance is critical, this robust family of pumps is known for reliability, durability and performance. These pumps are especially suited for harsh environments. Zoeller's cool run design and corrosion-resistant, powder coated epoxy finish add up to a long-lasting, trouble-free product.



### APPLICATIONS:

- STEP or onsite applications
- Water transfer
- Light commercial dewatering

### SPECIFICATIONS:

- 1-1/2" NPT discharge
- 1/2 HP through 1 HP
- Available in automatic or nonautomatic
- Model 137, 139, 140: 1/2" (12 mm) spherical solids capacity with vortex impeller
- Model 145: 3/4" (19 mm) spherical solids capacity with vortex impeller
- Bronze construction available (139 series)
- High head version available (145 series)
- Double shaft seal versions available for added protection on models 140/145.

For more information, see Technical Data Sheets FM2782, FM2783.

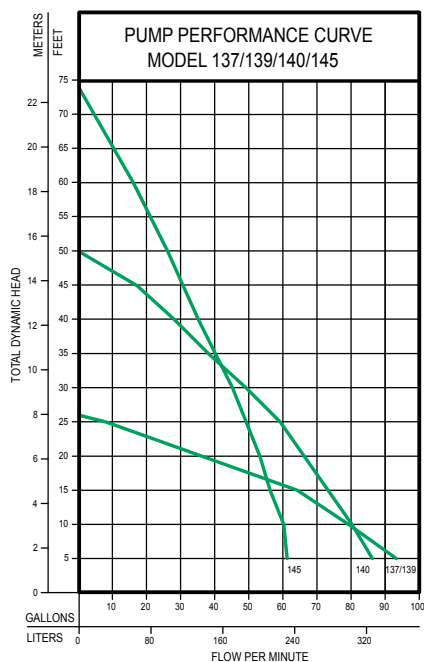

152656

# 151, 152, 153

## Dose-Mate

This is our fastest growing line of effluent pumps. The 150 series is truly a workhorse designed for reliability under extreme conditions in an effluent environment. 150 series pump curves cover a wide range of applications. They are well suited to applications with low pressure pipe (LPP) and enhanced flow STEP systems. Zoeller's cool run design and corrosion-resistant, powder coated epoxy finish, in addition to the hermetically sealed, oil-filled motor and non-clogging vortex impeller add up to a long-lasting, trouble-free product.



### APPLICATIONS:

- STEP or onsite applications
- Light commercial dewatering

### SPECIFICATIONS:

- 1-1/2" NPT discharge
- 3/10 HP through 1/2 HP
- Available in nonautomatic or with a variable level piggyback mechanical switch
- 1/2" (12 mm) spherical solids capacity with vortex thermoplastic impeller

For more information, see Technical Data Sheet FM2784.

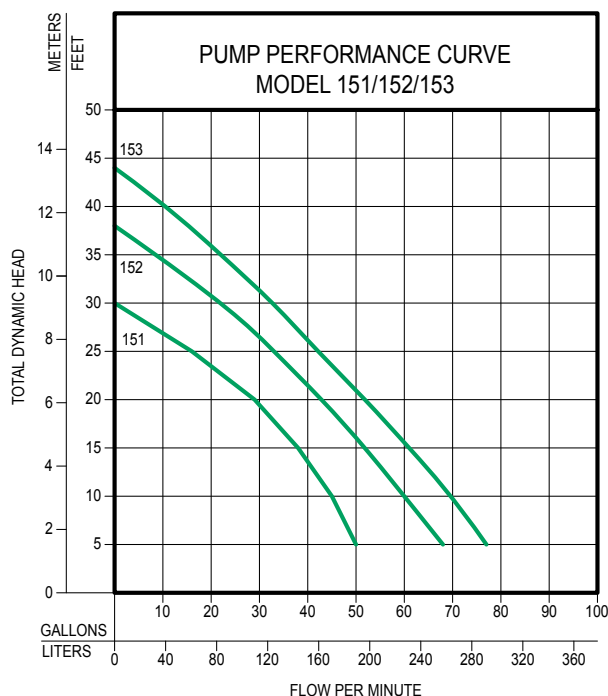

014508

# 161, 163, 165

## Flow-Mate

Heavy duty construction with oversized bearings and a balanced bronze, non-clogging vortex impeller allow these pumps to stand up to the highest heads and maximum flows. They are well suited to applications with low pressure pipe (LPP) and enhanced flow STEP systems. Using Zoeller's cool run design, we added fins to these pumps, lowering operating temperatures. The corrosion-resistant, powder coated epoxy finish and hermetically sealed, oil-filled motor add up to a long-lasting, trouble-free product.

### APPLICATIONS:

- Onsite or septic applications
- Enhanced flow STEP systems
- Commercial dewatering
- Sump / dewatering

### SPECIFICATIONS:

- 1-1/2" NPT discharge (available with 2" or 3" NPT bolt-on flange)
- 1/2 HP through 1 HP
- Available in automatic or nonautomatic
- 3/4" (19 mm) spherical solids capacity with bronze vortex impeller
- Hazardous environment/explosion proof version available (automatic and nonautomatic)
- Double shaft seal versions available for added protection
- Thermally protected motor

For more information, see Technical Data Sheet FM2785.

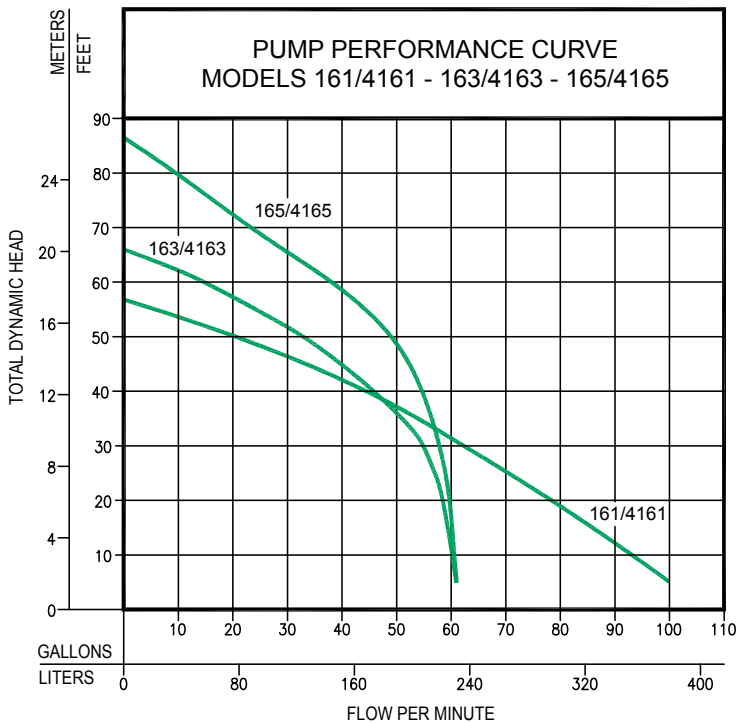

SUMP, EFFLUENT



Explosion-proof models available



# 185, 186, 188, 189, 191

## Flow-Mate

Heavy duty construction with oversized bearings and a balanced bronze, non-clogging vortex impeller allow this series of pumps to stand up to the highest heads and maximum flows. They are well suited to applications with low pressure pipe (LPP) and enhanced flow STEP systems. Using Zoeller's cool run design, we added fins to these pumps, lowering operating temperatures. The corrosion-resistant, powder coated epoxy finish and hermetically sealed, oil-filled motor add up to a long-lasting, trouble-free product.

SUMP, EFFLUENT

### APPLICATIONS:

- High head onsite or septic applications
- Enhanced flow STEP systems
- Commercial dewatering

### SPECIFICATIONS:

- 1-1/2" NPT discharge (available with 2" or 3" NPT bolt-on flange)
- 1 HP through 2 HP
- Available in automatic or nonautomatic
- 3/4" (19 mm) spherical solids capacity with bronze vortex impeller
- Model 191 has 5/8" (16 mm) spherical solid passing capacity
- Hazardous environment/explosion proof version available (automatic and nonautomatic)
- Double shaft seal versions available for added protection
- Thermally protected motor

For more information, see Technical Data Sheet FM2786.



Explosion-proof models available

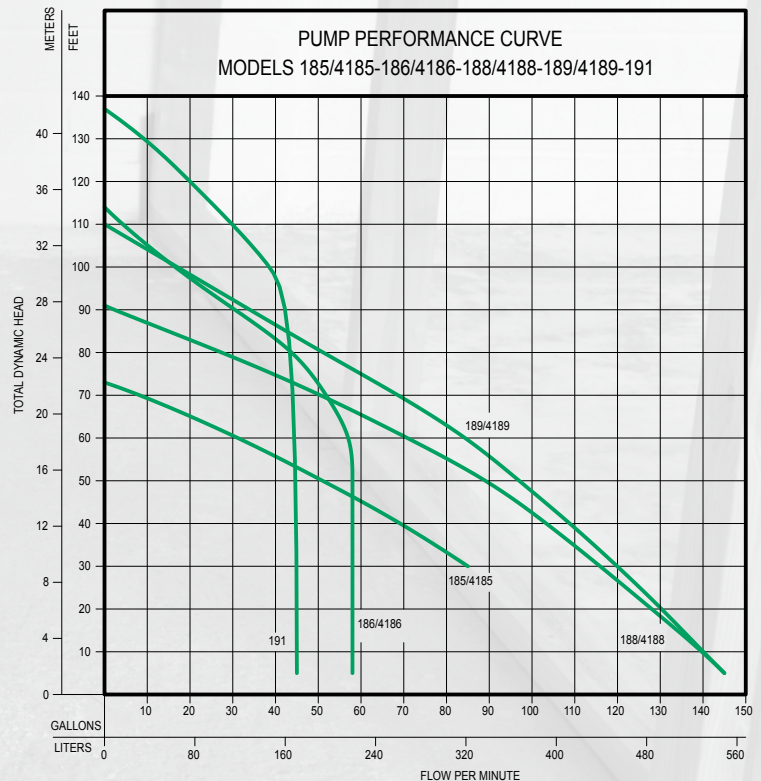

009903

## Builder Series

The Model 212 offers accessible quality for the cost conscious. This submersible pump is designed for use in residential or light commercial sewage applications and can be used to transfer groundwater, effluent, or sewage. The pump includes a cast iron motor housing with a corrosion-resistant, baked-on enamel finish and is designed to provide great heat dissipation from the motor, ensuring a long service life.



### APPLICATIONS:

- Residential sewage
- Water transfer and dewatering
- New construction

### SPECIFICATIONS:

- 2" NPT discharge
- 1/2 HP
- Available in automatic operation only
- 2" (50 mm) spherical solids capacity with non-clogging engineered plastic vortex impeller

For more information, see Technical Data Sheet FM2850.



Product may not be as pictured.

SEWAGE, DEWATERING

For complete product information, visit: [www.zoeller.com](http://www.zoeller.com)

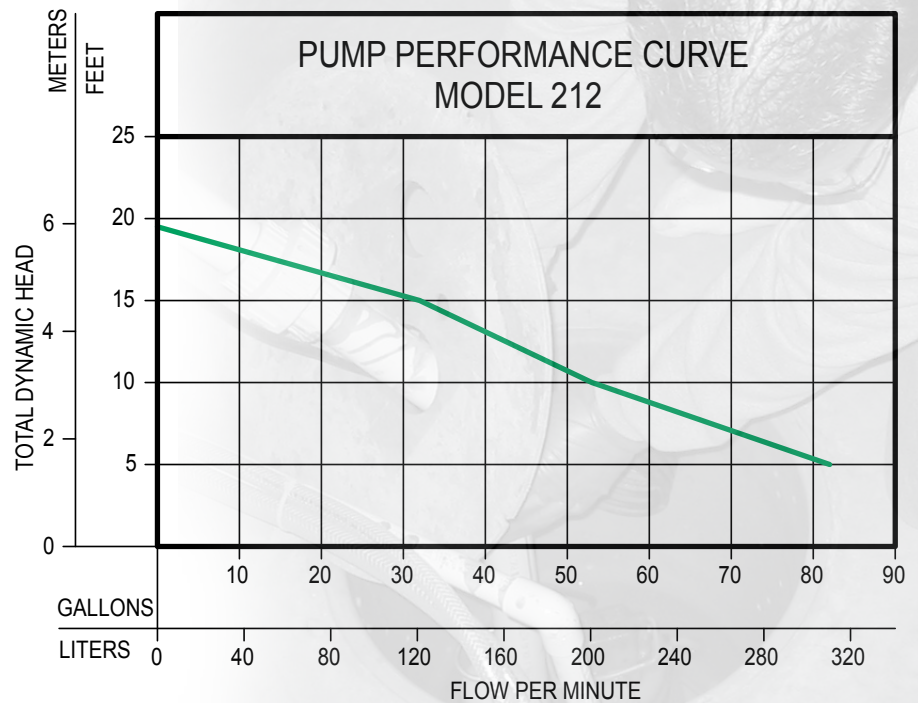

014718

# 264, 266, 267, 270

## Waste-Mate

Considered one of America's most popular sewage ejectors, this robust family of pumps is known for reliability, durability and performance. These pumps are industry-proven, built of cast iron with stainless steel hardware. The integral, preset snap-action float switch is engineered for one million mechanical starts. The heat-dissipating cast iron body with powder coated epoxy finish provides maximum pumping performance under the most extreme conditions. With a cool run design, the hermetically sealed, oil-filled motor and non-clogging vortex impeller add up to a long-lasting, trouble-free product.



### APPLICATIONS:

- Residential and light commercial sewage and dewatering
- New construction
- Wastewater / lift stations

### SPECIFICATIONS:

- 2" NPT discharge
- 4/10 HP through 1 HP
- Available in automatic or nonautomatic
- 2" (50 mm) spherical solids capacity with vortex thermoplastic impeller (cast iron available)
- Models 266 and 267 available in 3 phase voltages

For more information, see Technical Data Sheets FM2788, FM2789, FM2790.

For complete product information, visit:  
[www.zoeller.com](http://www.zoeller.com)

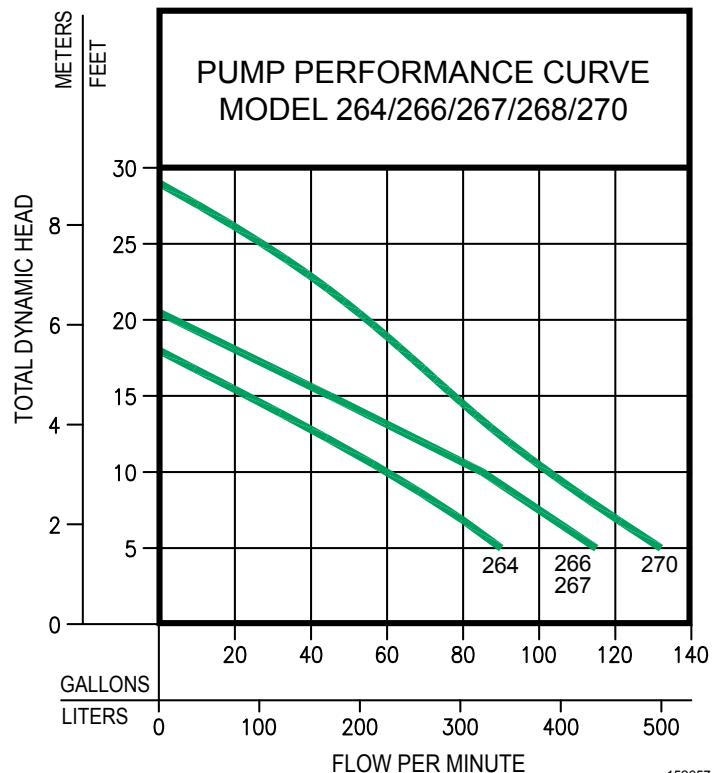



# 282, 284

## Waste-Mate

Heavy duty construction, oversized bearings and balanced non-clogging vortex impellers allow these pumps to stand up to the highest heads and maximum flows. Using Zoeller's cool run design, we added fins to these pumps, lowering operating temperatures. The corrosion-resistant, powder coated epoxy finish and hermetically sealed, oil-filled motor add up to a long-lasting, trouble-free product.



### APPLICATIONS:

- Commercial sewage and dewatering
- Wastewater
- Lift stations

### SPECIFICATIONS:

- 2" or 3" NPT flanged vertical discharge
- 1/2 HP and 1 HP
- Available in automatic or nonautomatic
- 2" (50 mm) spherical solids capacity with cast iron vortex impeller
- Thermally protected motor
- Hazardous environment/explosion proof version available (automatic and nonautomatic)
- Double shaft seal versions available for added protection

For more information, see Technical Data Sheet FM2791.

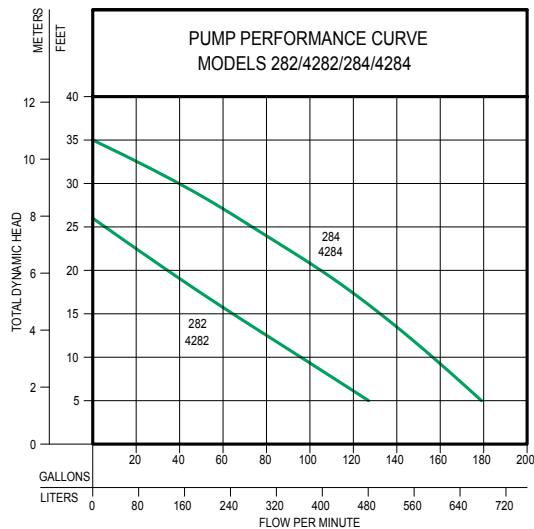

009927A

# 292, 293, 294, 295

## Waste-Mate

Heavy duty construction, oversized bearings and balanced non-clogging vortex impellers allow these pumps to stand up to the highest heads and maximum flows. Using Zoeller's cool run design, we added fins to these pumps, lowering operating temperatures. The corrosion-resistant, powder coated epoxy finish and hermetically sealed, oil-filled motor add up to a long-lasting, trouble-free product.



### APPLICATIONS:

- Commercial sewage and dewatering
- Wastewater
- Lift stations

### SPECIFICATIONS:

- 2" or 3" NPT flanged vertical discharge
- 1/2 HP through 2 HP
- Available in automatic or nonautomatic
- 2" (50 mm) spherical solids capacity with cast iron vortex impeller
- Thermally protected motor
- Hazardous environment/explosion proof version available (automatic and nonautomatic)
- Double shaft seal versions available for added protection

For more information, see Technical Data Sheet FM2792.

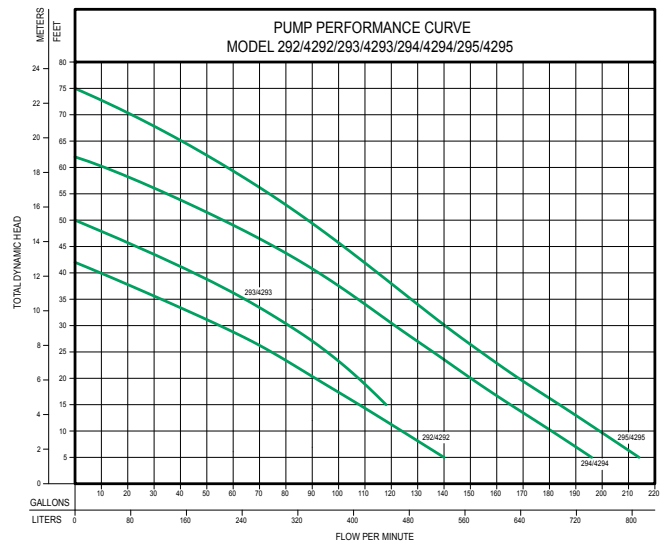

009919A

SEWAGE, DEWATERING

# 404, 405

## Waste-Mate

Designed to handle large solids and high flow rates, these pumps are ideal for quickly removing water as well as raw waste. Suited for parking lots and storm water transfer, the oversized bearings and balanced non-clogging vortex impellers allow these pumps to meet the most demanding applications. Using our cool run design, we added fins to these pumps, lowering operating temperatures. The corrosion-resistant, powder coated epoxy finish and hermetically sealed, oil-filled motor add up to a long-lasting, trouble-free product. Rail systems are available for ease of installation and removal.



### APPLICATIONS:

- High capacity dewatering
- Commercial sewage
- Storm water removal

### SPECIFICATIONS:

- 4" ANSI flange discharge
- 2 and 3 HP
- 3" (76 mm) spherical solids capacity with cast iron vortex impeller
- Hazardous environment/explosion proof, nonautomatic version also available
- Double shaft seal versions available for added protection
- Thermally protected motor

For more information, see Technical Data Sheet FM2793.

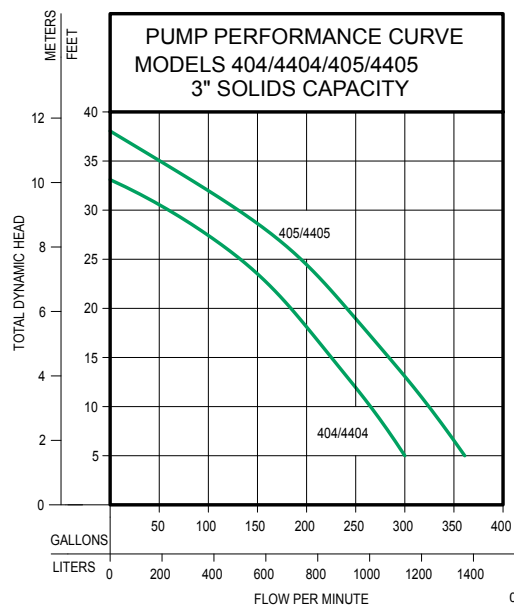

012116

# 611, 621, 631, 641, 651, 661

## Sewage Waste

Engineered for large commercial and industrial applications, these pumps utilize extended vane ductile iron impellers for improved efficiency and performance. The tandem seal design provides additional protection from abrasives typically found in demanding applications. Cooling fins, not commonly found in this type of pump, lower operating temperatures, providing longer motor and bearing life. Rail systems are available for ease of installation and removal.



### APPLICATIONS:

- Industrial and commercial wastewater
- Storm water removal
- Engineered lift stations

### SPECIFICATIONS:

- 3" NPT vertical or 3" or 4" ANSI flange discharge
- 1 HP through 7-1/2 HP
- 2-1/2" (64 mm) spherical solids capacity with cast iron, two vane, semi-open impeller
- Hazardous environment/explosion proof, nonautomatic version also available
- Double shaft seal for added protection

For more information, see Technical Data Sheet FM2794.

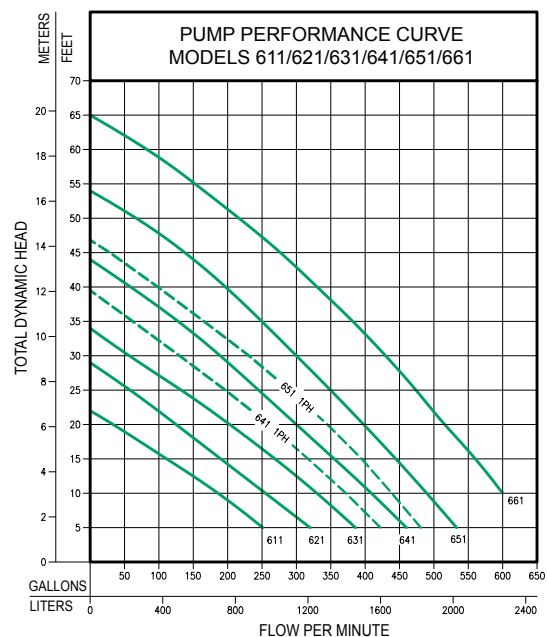

013859



# 915

## THE SHARK Series Grinder Package

The industry's only 115 volt, 1/2 HP grinder pump stands up to the toughest applications where traditional sewage pumps fail. This job-ready system uses our innovative Tri-slice® cutter. Stainless steel Tri-Slice® cutter requires little or no maintenance. The built-in scouring system and baffle keep debris from obstructing float operation. Small yet powerful, this efficient 7 amp pump handles most debris including: socks, denim, sanitary napkins, diapers, etc. The system is 100% preassembled for ease of installation.



For additional Grinder Packages incorporating the 803/805/807 see FM2819.

### APPLICATIONS:

- Residential wastewater
- 2" sewage ejection retro fits for most existing sewage basins
- Light commercial

### SPECIFICATIONS:

- 1-1/4" discharge (top discharge)
- 1/2 HP 115 V motor
- Baked-on, epoxy-coated cast iron motor housing
- Includes high water indoor alarm and 1-1/4" "silent" check valve
- Available as 18"x30" (46x76 cm) polystructural foam or 24"x24" (61x61 cm) poly basin
- Stainless steel carriage provides inlet baffle for less clogging
- Thermally protected motor

For more information, see Technical Data Sheet FM2795.

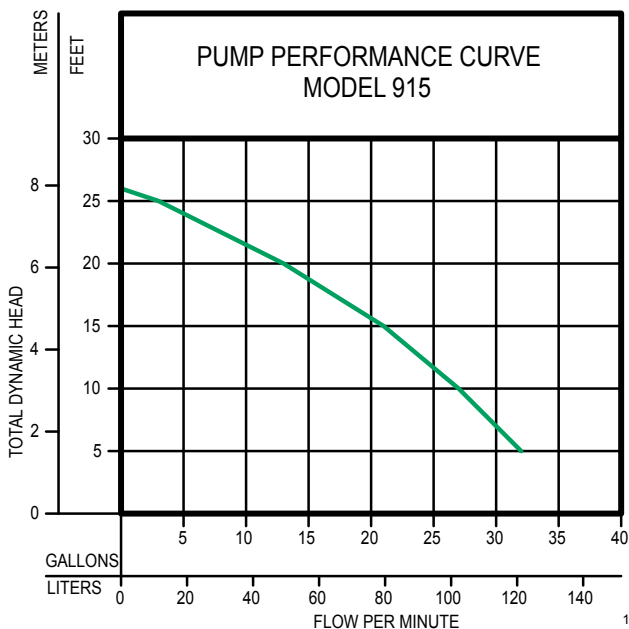

151790

# 803, 805, 807

## THE SHARK Series Grinder Pumps

Fractional HP Grinder Series. World's first integral automatic grinder. All cast iron grinder series for difficult residential applications where ejectors struggle. Handles entire household of "flushable" materials. 115/230 volt grinders for residential use without commercial grinder costs.



### APPLICATIONS:

- Residential wastewater
- Light commercial

### SPECIFICATIONS:

- 1-1/4" NPT discharge
- 803 - 1/2 HP, 805 - 3/4 HP, 807 - 1 HP
- Cast iron construction
- Oil-filled for optimal heat dissipation
- Thermally-protected motor

For more information, see Technical Data Sheet FM2882.

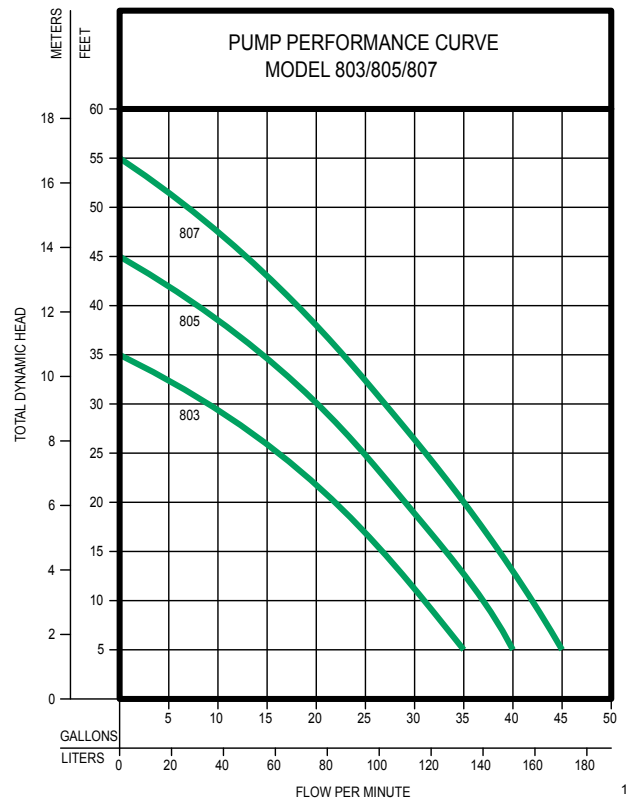

153604

GRINDER PUMPS

# 810, 815



## Progressing Cavity Grinder Pump

Designed for high pressure sewer systems, our Shark® Series progressing cavity grinder pumps offer a head capacity up to 240 feet (73 m). Constructed of corrosion-resistant cast iron with a powder coated epoxy finish and stainless steel hardware, these pumps are built for years of reliable service. The thermally protected, oil-filled motor and external cooling fins allow the pump to run cooler. An internal pressure relief valve protects the motor and hydraulic components from extreme spikes in sewer pressure. The hardened stainless steel star cutter provides scissor-action style cutting to virtually eliminate binding and roping of material around the cutter.



### APPLICATIONS:

- Residential sewage removal for pressure sewer systems
- Pressure sewer systems

### SPECIFICATIONS:

- 1-1/4" NPT discharge
- 1 through 2 HP
- Rockwell C55-60 hardened stainless steel cutter and disc

For more information, see Technical Data Sheet FM2796.

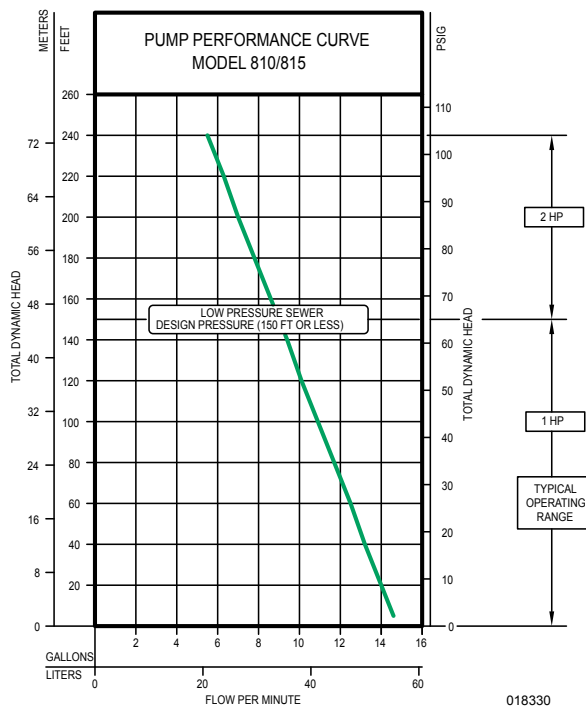

018330

# 932



## Simplex Replacement Grinder

The Progressing Cavity Grinder Replacement Pump easily adapts to most competitors' systems. The oil-filled, hermetically sealed, cool run motor design and hardened stainless steel cutter ensure long life and minimal maintenance. Unit comes completely assembled with check valve, anti-siphon valve, pressure relief valve, quick disconnect plumbing coupling and electrical receptacle fitting. Includes high level alarm as an added convenience.



### APPLICATIONS:

- Retrofit for existing progressing cavity grinder systems
- Pressure sewer systems

### SPECIFICATIONS:

- 1-1/4" NPT discharge
- Bolts to existing progressing cavity grinder pump systems
- Rockwell C55-60 hardened stainless steel cutter and disc

For more information, see Technical Data Sheet FM2797.

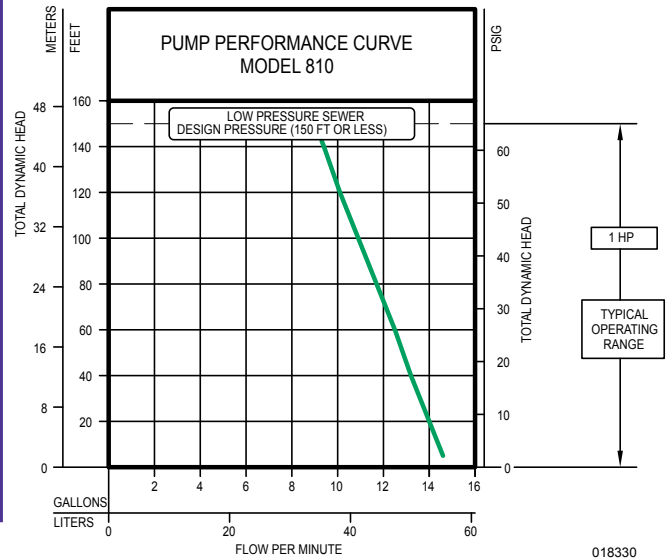

018330

# 818, 819 & 820

## THE SHARK Series Grinder Pumps 1.0, 1.5, & 2.0 HP

Designed for residential and light commercial pressure sewer systems, our Shark® Series grinder pump offers a head capacity up to 107 feet (33 m) and is built for years of reliable service. This pump is constructed of corrosion-resistant cast iron with a powder coated epoxy finish and stainless steel hardware. The hardened stainless steel Tri-Slice® cutter provides scissor-action style cutting that helps eliminate binding and roping of material around the cutter. The thermally protected, oil-filled motor and external cooling fins allow the pump to run cooler. With internal starting components, the Shark® can either run with an optional prewired float switch or a piggyback-style float as well as a traditional simplex or duplex control panel.

### APPLICATIONS:

- Residential and light commercial sewage grinder applications
- Pressure sewer systems

### SPECIFICATIONS:

- Tri-Slice®, two-bladed, high-torque cutter
- Scissorized cutting action shreds solids down to 7/32" and smaller
- 1-1/4" NPT discharge
- 1.0, 1.5, & 2.0 HP
- Rockwell C55-60 hardened 440 C stainless steel cutter and disc
- Vortex impeller
- 100% factory tested

For more information, see Technical Data Sheet FM2798.

**Grinder pumps are available in turnkey prepackaged and job ready systems for 1.0 to 2.0 HP grinder pump models.**

### BASIN ASSEMBLIES INCLUDE:

- 2 HP grinder pump
- Alarm panel with float switch for WD820 systems or simplex control panel with auto-reversing for E840 systems
- Junction box
- Float switches (E840 systems only)
- Packaged basin assembly available in fiberglass or ribbed polyethylene (pictured)



Tri-Slice®, two-bladed, high-torque cutter

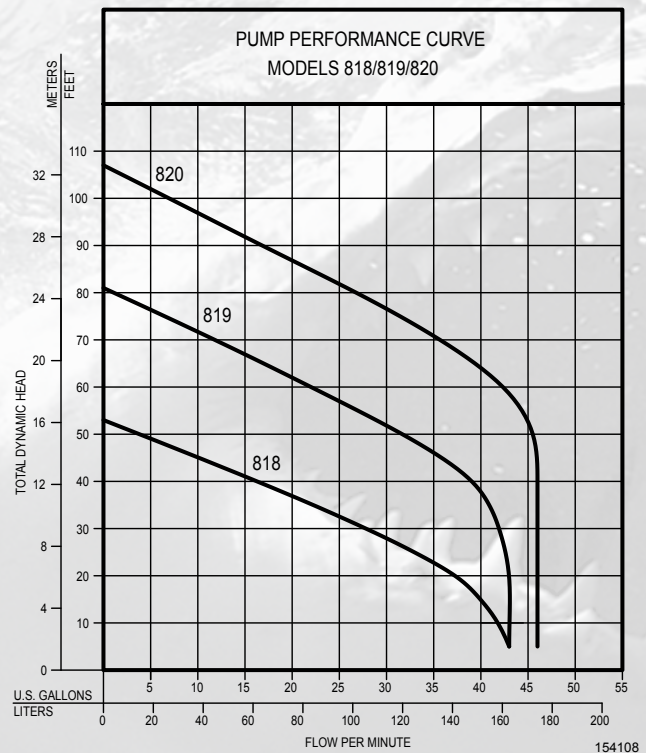

# 840, 841, 842



## Grinder Pump Systems and Reversing Controls

### FEATURES:

Designed for pressure sewer systems or traditional systems that have issues with clogging, the 840 Shark® Series grinder pumps offer a head capacity up to 125 feet (38 m). Constructed of corrosion-resistant cast iron with a powder coated epoxy finish and stainless steel hardware, these pumps are built for years of reliable service. The thermally protected, oil-filled motor and external cooling fins allow the pump to run cooler than most. The hardened 440 C stainless steel star shaped cutter provides scissor-action style cutting that helps eliminate binding and roping of material around the cutter. The 840 Shark® (excludes 841/842) offers the industry's only automatic, reversing impeller and cutter assembly that virtually double the life of ordinary grinder pumps.\*

\*Requires circuit in control panel to function.



### APPLICATIONS:

- Residential and commercial sewage grinder pump systems
- Pressure sewer systems

### SPECIFICATIONS:

- 1-1/4" NPT discharge
- 2 HP
- Model 840 AUTO-REVERSING star-cutter helps eliminate clogging
- Rockwell C55-60 hardened 440 C stainless steel cutter and disc
- Double shaft seal for added protection
- Vortex impeller
- Hazardous environment/explosion proof version available

For more information, see Technical Data Sheet FM2799.



Explosion-proof model

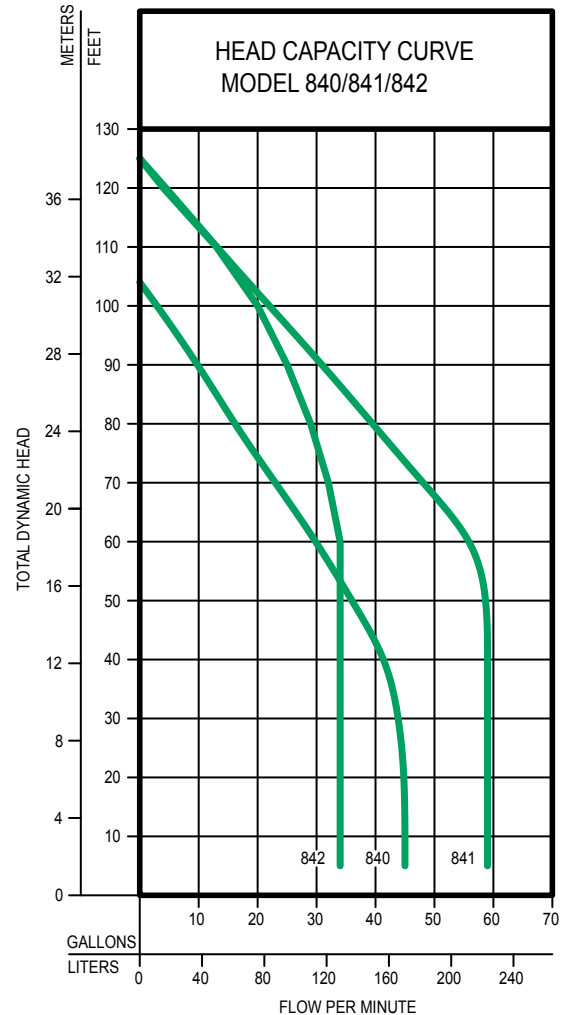



# Qwik Jon<sup>®</sup> Ultima

## Sewage Removal System

With multiple model configurations, this system provides the flexibility to install a bathroom almost anywhere. A smart solution for sewage removal where gravity flow is a problem, this compact system is preassembled for easy installation and low cost. With no need to destroy or elevate the floor, the grinder tank can be installed free-standing or behind the wall. This series is designed with convenient auxiliary inlets to accommodate a toilet, lavatory, bathtub, and/or shower in a basement, cottage, tool shed, holiday home, etc.

A powerful 1/2 HP motor delivers almost twice the shut-off head of the leading competitor. By utilizing grinder technology instead of a macerator, this system is engineered to never need cleaning and to remain maintenance-free for the life of the system. A "never dull" cutter assembly of hardened steel provides over 70,000 cuts per minute.



\*Model 1.28 only



### APPLICATIONS:

- Allows you to add a bathroom in previously unplumbed locations

### SPECIFICATIONS:

- 1" NPT discharge (can reduce down to 3/4")
- Discharge can be oriented in any direction
- ADA comfort height bowl
- Available with right or left hand flush
- Thermally protected motor
- Available with 1.28 gallons per flush (4.85 liters)
- Models available for rear flush toilet including pressure assisted

For more information, see Technical Data Sheet FM2800.

**Economical sewage systems designed for free-standing or built-in installation.**



Model 204 for shower only

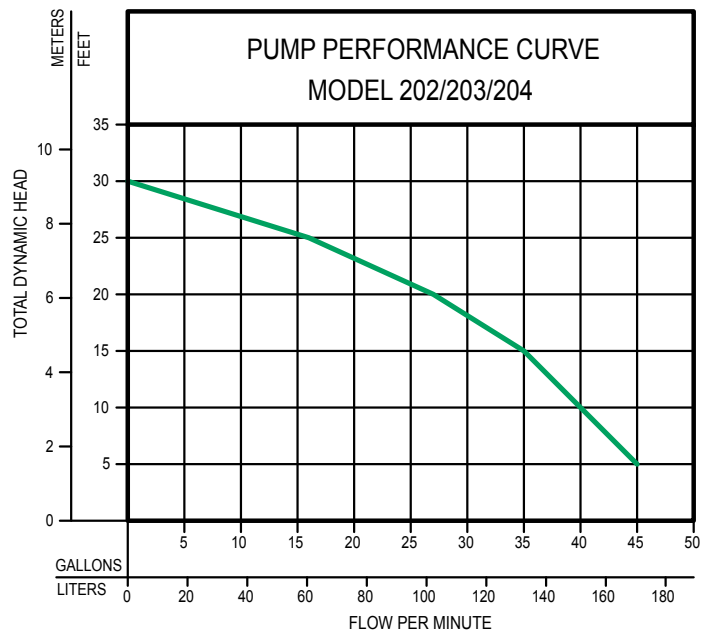

OTHER PRODUCTS



# Drain Pump



## Water Removal System

This is our most versatile water collection system. No need to dig a sump pit or re-route plumbing drain lines. This compact system includes everything you need to remove water from areas without gravity drains. Excellent for bar sinks, laundry trays or condensate removal. There are no inlet filters to clean, and easy compression fittings make for quick and trouble-free installations. As an added bonus, the P-trap can be located inside the tank if necessary.

### APPLICATIONS:

- Under bar
- Beauty salon / parlors
- Work sinks
- Laundry trays

### SPECIFICATIONS:

- 1-1/2" NPT discharge with 1-1/2" threaded vent
- 5 gallon (19 liter) capacity poly basin
- Includes 1-1/2" check valve
- 132 model available completely preassembled

For more information, see Technical Data Sheet FM2801.

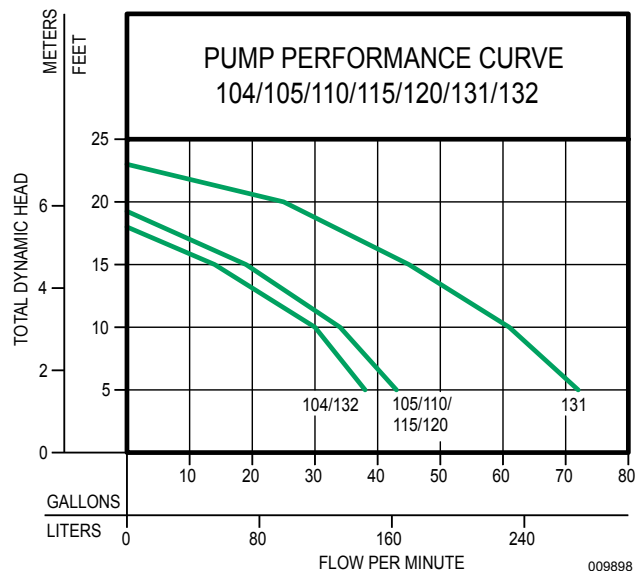

# Crawl Space



## Moisture and Mold Protection

This system is designed specifically with tight or restricted spaces in mind. Indoors or outdoors, eliminate standing water from areas without proper drainage. Prevent the accumulation of moisture, fungus, and odors commonly found in residential crawl spaces. The perforated basin and solid lid keep large debris from entering the pit, eliminating maintenance.

### APPLICATIONS:

- Dewatering in crawl spaces
- Dewatering under mobile homes

### SYSTEM INCLUDES:

- Automatic pump
- 24' (7 m) hose
- Tank assembly
- Check valve

For more information, see Technical Data Sheet FM2802.

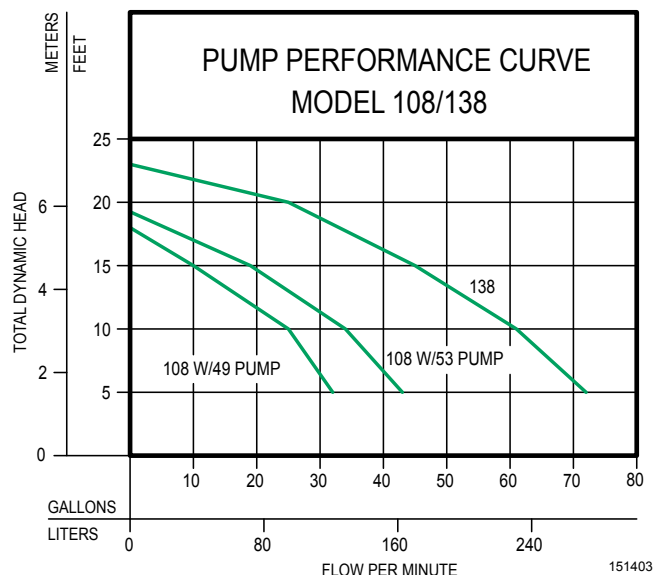

# Zoeller Backup Systems

## Battery Backup Pedestal Sump Pump

This is our most powerful back-up pumping system. With over 25 years



of proven performance in the field, the AquaNot® is the proven solution for extra protection when your primary pump fails for any reason. A heavy duty 12 V motor with a positive contact float switch discharges water as fast as many primary pumps. The fully automatic, electronic 28 amp, UL recognized charger monitors and maintains the system at peak readiness. The high water alarm, stainless steel column and shaft, and non-corrosive pump housing add to this system's features.



585 pump



28 amp charger

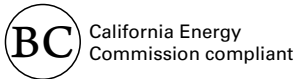

### APPLICATIONS:

- Continuous pumping during power outage

### SPECIFICATIONS:

- 1-1/2" NPT discharge
- Includes 28 A charger
- Adjustable float

For more information, see Technical Data Sheet FM2806.

## 12 Volt Battery Backup Sump Pump



The high performance AquaNot® Series (Model 508) provides extra protection when a primary AC pump shuts down due to a power outage or another electrical problem. An automatic, 10 amp, UL recognized charger/controller with battery burnout and overcharge protection maximizes battery life and provides over 7 hours of continuous pumping. All necessary pipes, valves, and fittings are included to transform your existing system into a complete AC/DC sump pump system. The alarm, light indicator, and warning system ensure peace of mind for the homeowner.

The Basement Sentry® Series (Model 507) is also available for applications where higher pump performances are not desired.

\* Primary electric sump pump not included for either model.

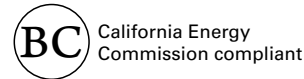

### APPLICATIONS:

- Continuous pumping during power outage

### SPECIFICATIONS:

- 1-1/2" NPT discharge includes check valves
- Includes all necessary fittings for installation

For more information, see Technical Data Sheet FM2804.

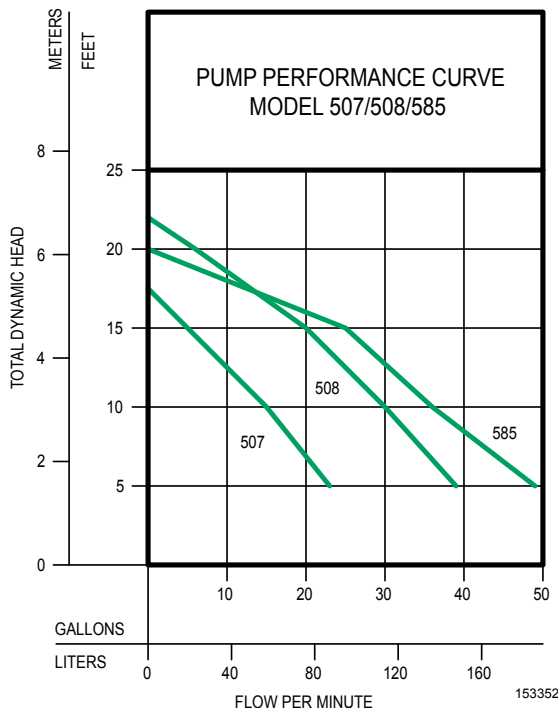

Basement Sentry®  
(Model 507) pictured

OTHER PRODUCTS

# Aquanot® Active 508

## Battery Backup Pump



This sump pump system takes over when the main power is interrupted or the primary pump isn't getting the job done. The powerful, self-testing Active smart-controller overcomes problems caused by dormancy and system neglect. It is internet-connected through the all new Z Control® Platform, granting users free 24/7 monitoring and remote control of equipment with the Z Control® mobile app or web interface. You can also receive free emails, texts, and push notifications about system status.



### APPLICATIONS:

- Continuous pumping during power outage or primary pump failure

### SPECIFICATIONS:

- 1-1/2" NPT discharge
- Integrated check valves
- Includes 508 DC pump, Active controller, Z Control® Gateway, vertical operational switch, Reed high-water switch, battery box, fittings, and more.

For more information, see Technical Data Sheet FM2926.

Free Z Control® account at [www.ZControlCloud.com](http://www.ZControlCloud.com)



Search: "Z Control"

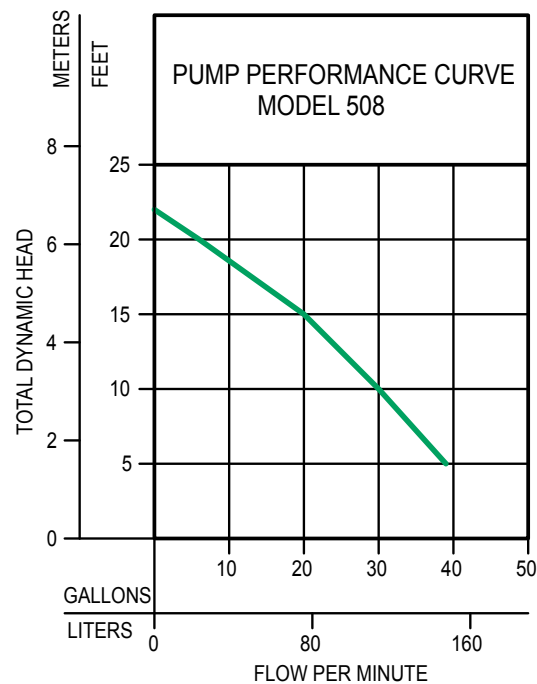

OTHER PRODUCTS

# Zoeller Backup Systems

## Preassembled 12 Volt Battery Backup Sump Pump Package



Save time and money with our top selling primary and back-up sump pump packages. Complete with alarm, light indicator, and warning system. An automatic, UL recognized 10 amp charger/controller maximizes battery life and provides over 7 hours of continuous pumping. Battery burn-out and overcharge protection added piece of mind.

Preassembled primary and back-up sump pump packages available for both high performance Aquanot® Series (Model 508) and Basement Sentry® Series (Model 507), where higher pump performances are not desired.



### APPLICATIONS:

- Continuous pumping during power outage

### SPECIFICATIONS:

- 1-1/2" NPT discharge with inline check valve
- Completely preassembled – ready to install
- Includes "America's favorite sump pump"

For more information, see Technical Data Sheet FM2803.

**For complete product information, visit:  
[www.zoeller.com](http://www.zoeller.com)**

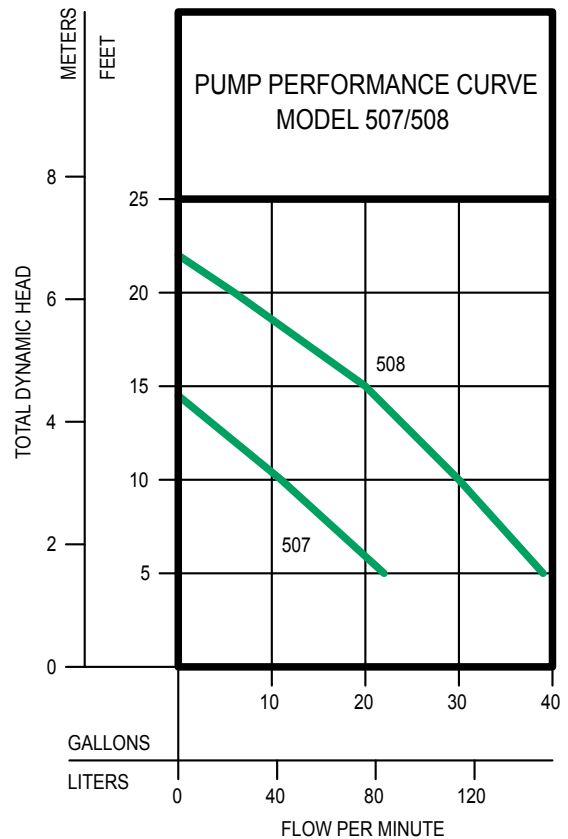

153036

**OTHER PRODUCTS**

# Zoeller Backup Systems

## Water-Powered Emergency Backup Sump Pump System



Keep your basement dry with the Home Guard® Max. With no electricity or batteries required to operate, this pump automatically takes over when needed during a power outage. It requires municipal water pressure to function properly. No need to worry about excess water usage. As a backup system, it only uses water when activated. Fully assembled for fast, easy and trouble-free installation. Its small footprint allows for installation in even the smallest sump pits. Units available with a high water alarm.

\* Primary electric sump pump not included



### APPLICATIONS:

- Continuous pumping during power outage using city water pressure

### SPECIFICATIONS:

- 1-1/2" discharge
- PVC construction
- Operates up to 80 PSI
- Available with high water alarm
- Low profile model available. 7" (17.8 cm) shorter than standard model.

For more information, see *Technical Data Sheet FM2805*.

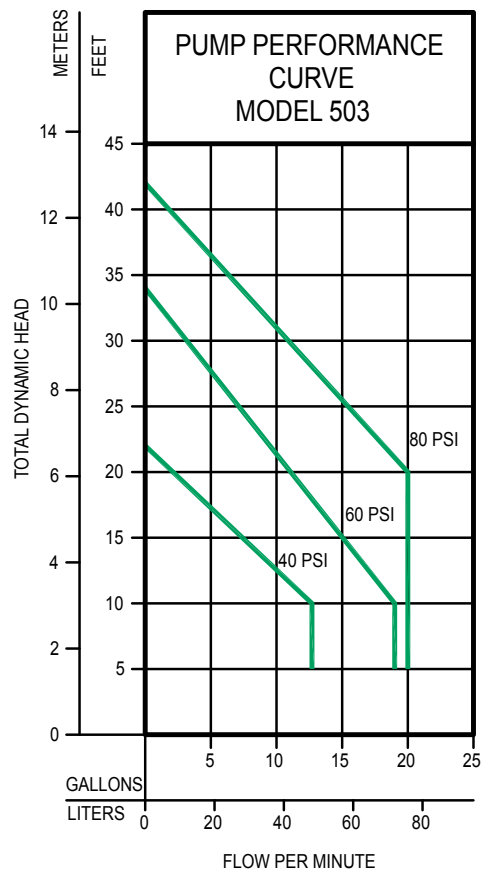



# Scale Removal

## 109 SRS Series

This preassembled system is engineered to meet the flushing requirements of tankless water heaters. An internal, reusable filter sock captures debris removed from the pipe system. A durable, air-filled 1/6 HP submersible pump and 3/4" stainless steel braided flush lines ensure quality and reliability for years of trouble-free performance. Recommended by professionals job after job, this system is an ideal and economical tool for plumbing contractors who install and service tankless water heating systems.

*Patent pending*



### APPLICATIONS:

- Removes line build-up in tankless water heating units

### SYSTEM INCLUDES:

- 1/6 HP pump
- Stainless steel braided hoses
- Poly tank with sealed cover
- Fittings

*For more information, see Technical Data Sheet FM2807.*

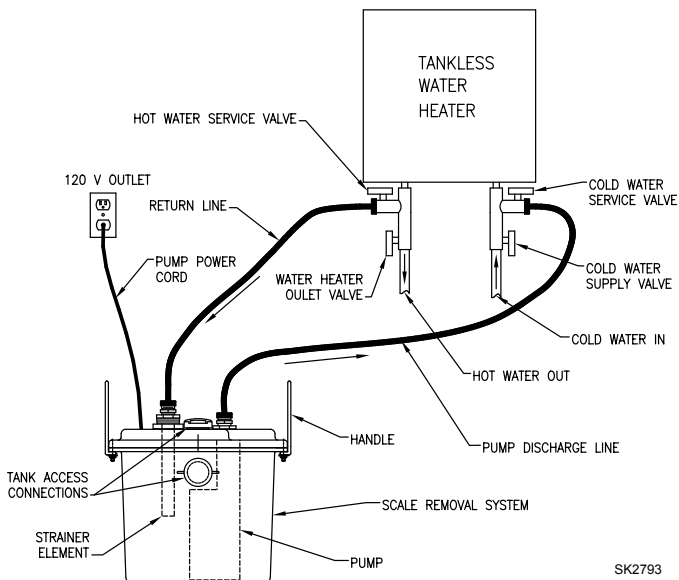

SK2793

# Condensate

## Model 521 Multi-purpose Condensate Pump



A built-in safety switch automatically shuts down the system in the event of a failure. Hanging tabs, vibration-dampening feet and multiple inlets allow installation flexibility and quiet operation. An oversized reservoir is provided, reducing pump starts for longer system life.

### APPLICATIONS:

- Automatically removes condensation from a variety of systems including air conditioning units, dehumidifiers and refrigeration systems.

### SPECIFICATIONS:

- Built-in check valve
- Safety switch and alarm indicator lights
- Oversized reservoir

*For more information, see Technical Data Sheet FM2808.*

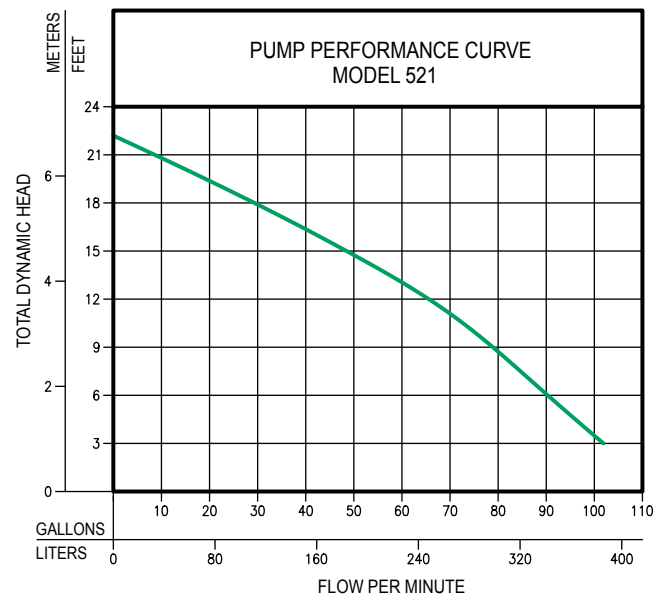

151234

OTHER PRODUCTS

# Oil Guard® Systems

Engineered to recognize the difference between water and oil, these systems help protect the environment and equipment from the dispersion of oils and/or hydrocarbons by only pumping water. They are perfect for elevator sumps, transformer vaults, or other applications where there is a need to remove water containing oil. Independently verified by OnSpeX, division of CSA, the Oil Guard® includes one of four pump models, Oil Smart® Pump Switch and alarm. Multiple features and options are available including NEMA-4X alarm panel enclosure, audible and light alarms and dry contacts.



## APPLICATIONS:

- Elevator vaults
- Transformer vaults
- Boat hulls

## SPECIFICATIONS:

- NEMA 4X alarm panel includes dry contacts for remote alarm
- Elevator systems require a minimum 50 GPM (189 LPM) and a maximum 6' (2 m) pump cord
- Custom systems available

For more information, see Technical Data Sheet FM2809.

For complete product information, visit:  
[www.zoeller.com](http://www.zoeller.com)



10-2149  
Simplex panel

10-2150  
Duplex panel

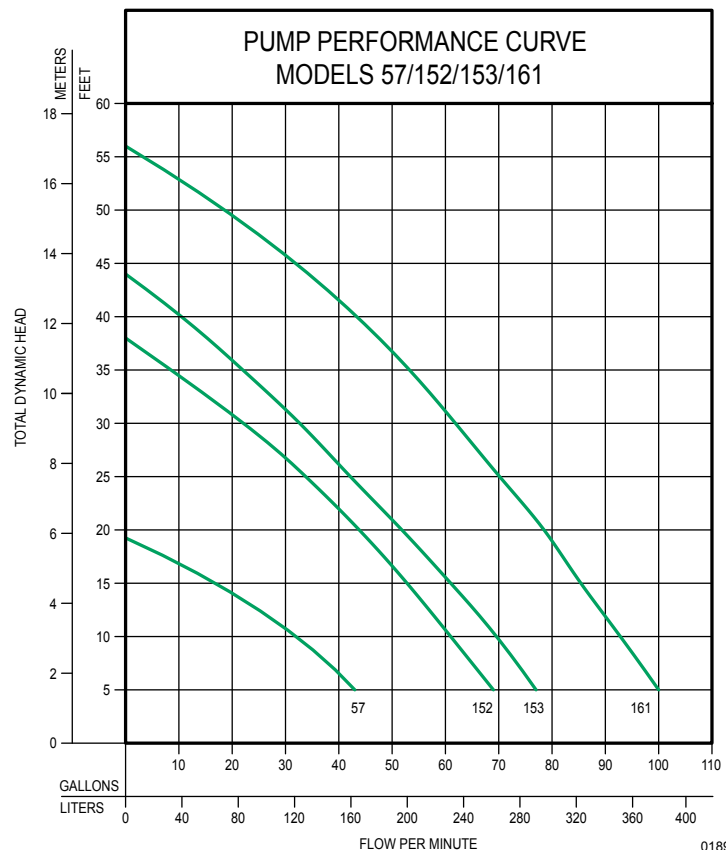

# 912 Systems

## Package Systems

With well over 100 variations, these preassembled packages include our industry-proven sewage ejectors and are job-ready to meet the needs of both residential and commercial applications. For indoor or outdoor use, all you need to do is connect your piping and plug in. Also available in duplex configurations.

## Prefabricated Package Systems

Zoeller offers a complete line of prepackaged and preassembled lift stations using sump, effluent, sewage or grinder pumps! Utilizing everything from a small 1/2 HP pump to the large 7-1/2 HP non-clogging pump, Zoeller will prefabricate any lift station as an engineered factory system. The headache of keeping track of product compatibility is eliminated, and the contractor is ensured that each system's components will properly operate with one another, and that the unit will be simple to install.

### SPECIFICATIONS:

- All package systems are reviewed for product compatibility
- Simplex or duplex systems available
- Indoor (top discharge) or outdoor (side discharge) systems available
- Many custom sizes and applications are available (consult factory)
- Loose systems available for field installation (consult factory)

For more information, see *Technical Data Sheet FM2810*.

912 simplex systems  
shown



# High-Temp Pumps

This series of submersible pumps is designed for use in residential or commercial dewatering applications and can be used to transfer groundwater and wastewater. These durable cast iron pumps include a powder coated epoxy finish to prevent corrosion and are designed to meet specifications with assurance by using high temperature parts rated for continuous 200°F (93°C) contact. Available in a variety of models and performances, each pump is 100% factory tested to ensure quality and reliability for years of trouble-free performance! This attention to detail is an inherent feature of every model in this pump series, making it one of the most reliable in the industry.



### APPLICATIONS:

- Commercial laundry facilities
- Boiler blow down application
- Maintenance facilities

### SPECIFICATIONS:

- 2000 Series rated for intermittent 200° F (93° C)
- 3000 Series rated for continuous 200° F (93° C)
- 1-1/2" – 3" NPT Discharge
- 3/10 HP through 1/2 HP
- Available in automatic or nonautomatic

For more information, see *Technical Data Sheet FM2811*.



Model 2057

OTHER  
PRODUCTS

# Agricultural

## Models 4290 and 4291 High Head Agricultural Pump

This series of submersible sewage pumps is designed for use in agricultural applications, lagoon recirculation systems, and sump pit systems. These durable cast iron pumps include a powder coated epoxy finish to prevent corrosion and a hermetically sealed, oil-filled motor housing that provides great heat dissipation and keeps the pumps running cooler. The non-clogging vortex impeller design reduces the risk of clogging and provides great solids passing capability. Pontoons and floats are available.



### APPLICATIONS:

- Specifically designed for lagoon or sump pit applications
- Farming industry
- Agricultural industry

### SPECIFICATIONS:

- 2" NPT discharge (available with 3" NPT bolt-on flange)
- 1/2 HP through 1 HP
- Available in automatic or nonautomatic
- 1-1/2" (38 mm) spherical solids capacity with bronze vortex impeller
- Tandem seals with silicon carbide/silicon carbide lower seal and carbon/silicon carbide upper seal

For more information, see Technical Data Sheet FM2812.

For complete product  
information, visit:  
[www.zoeller.com](http://www.zoeller.com)

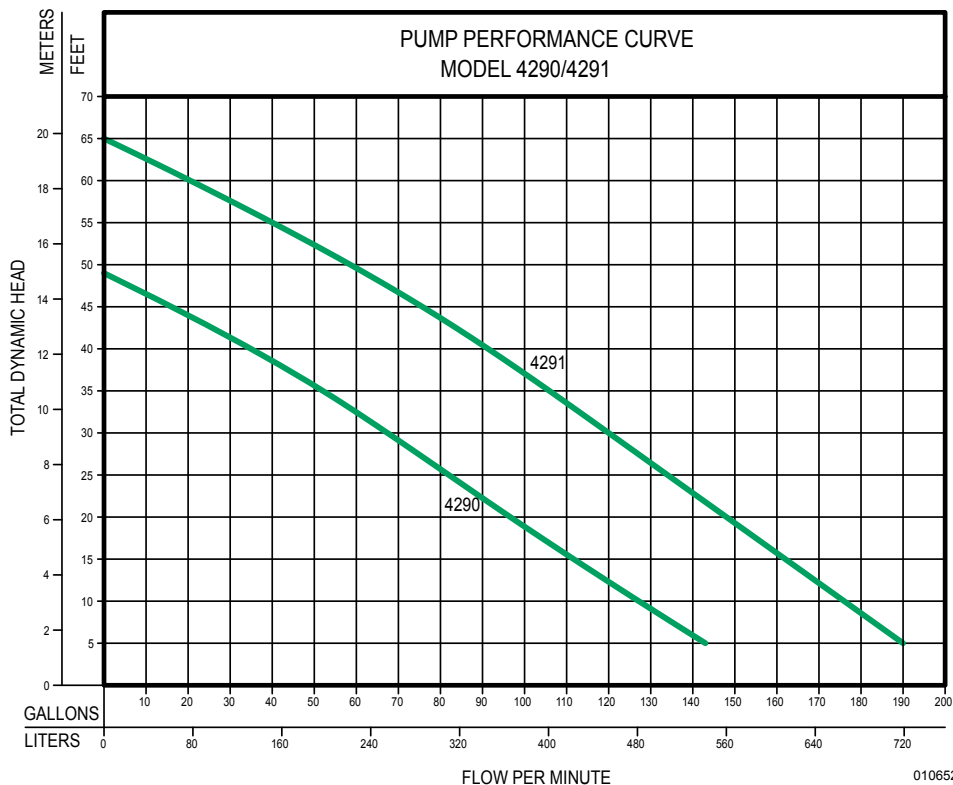



# Aeration/Fountain

## Model 370

This aeration and fountain pump adds a unique focal point and value to your property. The environmentally friendly, water-cooled motor eliminates pollution risk and pond contamination. The continuous-duty pump operates in 5' (1.5 m) or more of water and aerates up to 4,900 gallons (22,276 L) per hour. It produces a water fountain up to 15' (5 m) in height, and it includes three easily interchangeable patterns. The flotation system incorporates a UV-resistant, polyethylene float and eye-bolts for anchoring.



### APPLICATIONS:

- Golf courses
- Subdivisions
- Office parks
- Reduces mosquitoes
- Helps eliminate stagnant water

### SPECIFICATIONS:

- Preassembled with 100' (30 m) GFCI protected power cord
- For more information, see Technical Data Sheet FM2813.*





# Technical Specs

## UTILITY, PEDESTAL

See pages 3, 4

Model	HP	Discharge	Volts	Ph	Operation	Std. Cord Length	Width	Height	Weight	Gallons per minute (GPM) @ Height						Shut Off
										5 ft.	10 ft.	15 ft.	20 ft.	25 ft.	30 ft.	
42	1/6	1"	115	1	Non	9 ft.	6"	9-1/2"	7.3	15	11	6	--	--	--	19
44/LM44	1/4	1"	115	1	Non	9 ft.	6"	11-3/4"	7.7/8.7	30	22	12	--	--	--	20
46	1/2	2"	115	1	Non	9 ft.	8"	14-1/2"	16	55	47	37	25	5	--	33
311		hose	115	1	Non	6 ft.			7.75	Maximum flow @ 1 ft. Head = 5.6 GPM						39
314	1/2	hose	115	1	Non	9 ft.			17	21	20	19	--	--	--	23
81	1/3	1-1/4"	115	1	Auto	7-1/2 ft.	9.55	31-1/4"	15	50	36	10	--	--	--	16
82	1/3	1-1/2"	115	1	Auto	7-1/2 ft.	9.55	31-3/4"	19	52	41	12	--	--	--	17
84	1/2	1-1/2"	115	1	Auto	7-1/2 ft.	9.55	32-1/2"	22.5	59	51	38	17	--	--	24

## SUMP, EFFLUENT, DEWATERING

See pages 5-9

Model	HP	Discharge	Volts	Ph	Operation	Double Seal Option	Auto Std. Cord Length	Width	Height*	Gallons per minute (GPM) @ Height											Shut Off	
										5 ft.	10 ft.	15 ft.	20 ft.	25 ft.	30 ft.	35 ft.	40 ft.	50 ft.	60 ft.	70 ft.		80 ft.
49	1/4	1-1/2"	115	1	Auto		9 ft.	8-3/32"	10-1/2"	32	25	10	--	--	--	--	--	--	--	--	--	18
53, 55, 57, 59	3/10	1-1/2"	115, 230	1	Auto/Non		9 ft.	10-3/32"	10-1/6"	43	34	19	--	--	--	--	--	--	--	--	--	19.25
63	3/10	1-1/2"	115	1	Auto		10 ft.	10-3/32"	10-1/6"	43	34	19	--	--	--	--	--	--	--	--	--	19.25
73	1/3	1-1/2"	115	1	Auto		9 ft.	8 3/32"	11"	38	30	14	--	--	--	--	--	--	--	--	--	18
75	1/2	1-1/2"	115	1	Auto		10 ft.	8 3/32"	12 3/8"	50	40	30	17	--	--	--	--	--	--	--	--	25
95	1/2	1-1/2"	115	1	Auto		15 ft.	10-1/8"	12"	80	68	50	28	5	--	--	--	--	--	--	--	26
98	1/2	1-1/2"	115, 230	1	Auto/Non		15 ft.	10-1/8"	12"	72	61	45	25	--	--	--	--	--	--	--	--	23
137, 139	1/2	1-1/2"	115, 230, 200-208, 460	1, 3	Auto/Non		10 ft.	12-1/4"	12-3/4"	93	79	64	36	8	--	--	--	--	--	--	--	26
140	1	1-1/2"	115, 230	1	Non	✓	20 ft.	10-3/16"	12-13/32"	86	80	73	66	59	49	38	28	--	--	--	--	50
145	3/4	1-1/2"	115	1	Non	✓	20 ft.	10-3/16"	12-13/32"	61	60	56	53	49	45	40	35	26	16	--	--	74
										5 ft.	10 ft.	15 ft.	20 ft.	25 ft.	30 ft.	40 ft.	50 ft.	60 ft.	70 ft.	80 ft.	90 ft.	
151	1/3	1-1/2"	115, 230	1	Auto/Non		20 ft.	11"	16 1/2"	50	45	38	29	16	--	--	--	--	--	--	--	30
152	4/10	1-1/2"	115, 230	1	Auto/Non		20 ft.	11"	16 1/2"	69	61	53	44	34	23	--	--	--	--	--	--	38
153	1/2	1-1/2"	115, 230	1	Auto/Non		20 ft.	11"	16 1/2"	77	70	61	52	42	33	22	11	--	--	--	--	44
161	1/2	1-1/2" or 2" or 3"	115, 230, 200-208, 460, 575	1, 3	Auto/Non	✓	20 ft.	12-3/4"	18-9/16"	100	93	86	79	71	62	45	20	--	--	--	--	56
163	1/2	1-1/2" or 2" or 3"	115, 230, 200-208, 460, 575	1, 3	Auto/Non	✓	20 ft.	12-3/4"	18-9/16"	61	60	60	59	57	55	46	33	15	--	--	--	66
165	1	1-1/2" or 2" or 3"	230, 200-208, 460, 575	1, 3	Auto/Non	✓	20 ft.	12-3/4"	18-9/16"	61	60.5	60.3	60	59	58	55	50	39	22.5	10	--	86.5
										5 ft.	10 ft.	20 ft.	30 ft.	40 ft.	50 ft.	60 ft.	70 ft.	80 ft.	90 ft.	100 ft.	110 ft.	
185	1	1-1/2" or 2" or 3"	230, 200-208, 460, 575	1, 3	Auto/Non	✓	20 ft.	12-3/4"	18-9/16"	--	--	--	85	70	51	32	9	--	--	--	--	73
186	1-1/2	1-1/2" or 2" or 3"	230, 460	1, 3	Auto/Non	✓	20 ft.	12-3/4"	18-9/16"	58	58	58	58	58	58	58	52	45	30.5	16	4	114
188	1-1/2	1-1/2" or 2" or 3"	230, 200-208, 460, 575	1, 3	Auto/Non	✓	20 ft.	12-3/4"	18-9/16"	145	140	128	116	103.5	90	71	51	28	2	--	--	91
189	2	1-1/2" or 2" or 3"	230, 200-208, 460, 575	1, 3	Auto/Non	✓	20 ft.	12-3/4"	18-9/16"	145	140	130.5	120	109	97	85	69	51	34	17	--	110
										5 ft.	10 ft.	20 ft.	30 ft.	40 ft.	60 ft.	80 ft.	90 ft.	100 ft.	110 ft.	120 ft.	130 ft.	
191	2	1-1/2" or 2" or 3"	230	1	Non		20 ft.	12-3/4"	18-9/16"	45	45	45	45	45	45	45	45	40	30	20	10	137

\* Single Seal Units

**NOTES:**

- BN/BE Models available packaged with a piggyback variable level float switch.
- A double shaft seal available on 140, 160 & 180 series.

# Technical Specs

## SEWAGE and DEWATERING

See pages 10-13

Model	HP	Discharge	Volts	Ph	Operation	Double Seal Option	Std. Cord Length	Width	Height*	Gallons per minute (GPM) @ Height												Shut Off
										5 ft.	10 ft.	15 ft.	20 ft.	25 ft.	30 ft.	40 ft.	50 ft.	60 ft.	70 ft.	80 ft.	90 ft.	
212	1/2	2"	115	1/2	Auto		10 ft.	9-7/8"	15-7/8"	82	53	32	--	--	--	--	--	--	--	--	--	19.5
264	4/10	2"	115, 230	1	Auto/Non		15 ft.	13-9/64"	14-3/4"	90	60	23	--	--	--	--	--	--	--	--	--	18
266, 267	1/2	2"	115, 230, 200-208, 460	1, 3	Auto/Non		10 ft./15 ft.	13-5/32"	14-9/32"	115	85	45	10	--	--	--	--	--	--	--	--	20.5
270	1	2"	115, 230	1	Non	✓	20 ft.	13-1/16"	15"	132	101	77	56	29	--	--	--	--	--	--	--	29
282	1/2	2" or 3"	115, 230, 200, 460, 575	1, 3	Auto/Non	✓	10 ft./15 ft.	13-9/16"	18-13/16"	127	96	64	34	6	--	--	--	--	--	--	--	26
284	1	2" or 3"	230, 200, 460, 575	1, 3	Non	✓	10 ft./15 ft.	13-9/16"	18-13/16"	179	157	133	106	73	42	--	--	--	--	--	--	35
292	1/2	2" or 3"	115, 230, 200, 460, 575	1, 3	Auto/Non	✓	20 ft.	12-7/8"	18-9/16"	140	124	108	91	75	56	10	--	--	--	--	--	42
293	1	2" or 3"	230, 200, 460, 575	1, 3	Auto/Non	✓	20 ft.	12-7/8"	18-9/16"	--	--	118	108	96	82	48	--	--	--	--	--	50
294	1-1/2	2" or 3"	230, 200, 460, 575	1, 3	Auto/Non	✓	20 ft.	12-7/8"	18-9/16"	196	181	165	150	136	121	94	58	13	--	--	--	62
295	2	2" or 3"	230, 200, 460, 575	1, 3	Auto/Non	✓	20 ft.	12-7/8"	18-9/16"	214	199	184	168	154	140	115	89	59	23	--	--	75
										5 ft.	10 ft.	15 ft.	20 ft.	25 ft.	30 ft.	35 ft.	40 ft.	45 ft.	50 ft.	55 ft.	60 ft.	
404	2	4"	230, 200-208, 460, 575	1, 3	Non	✓	20 ft.	16-1/8"	26"	300	265	224	184	134	60	--	--	--	--	--	--	33
405	3	4"	230, 200, 460, 575	1, 3	Non	✓	20 ft.	12-3/4"	18-9/16"	361	326	284	241	197	134	50	--	--	--	--	--	38
611	1	3" or 4"	230, 200, 460, 575	1, 3	Non	Standard	25 ft.	17-9/16"	29-1/4"	255	190	110	35	--	--	--	--	--	--	--	--	22
621	1-1/2	3" or 4"	230, 200, 460, 575	1, 3	Non	Standard	25 ft.	17-9/16"	29-1/4"	340	277	215	143	72	--	--	--	--	--	--	--	29
631	2	3" or 4"	230, 200, 460, 575	1, 3	Non	Standard	25 ft.	17-9/16"	29-1/4"	385	330	275	220	150	80	--	--	--	--	--	--	35
641	3	3" or 4"	230, 200, 460, 575	1, 3	Non	Standard	25 ft.	17-9/16"	29-1/4"	480	430	380	325	270	208	143	72	--	--	--	--	44
651	5	3" or 4"	230, 200, 460, 575	1, 3	Non	Standard	25 ft.	17-9/16"	29-1/4"	575	533	490	440	390	335	280	220	150	80	--	--	55
661	7-1/2	3" or 4"	230, 200, 460, 575	3	Non	Standard	25 ft.	17-9/16"	29-1/4"	--	600	560	515	475	430	383	330	280	220	150	85	65

\* Single Seal Units

## GRINDER PUMPS

See pages 14-17

Model	HP	Discharge	Volts	Ph	Operation	Std. Cord Length	Width	Height*	Gallons per minute (GPM) @ Height												Shut Off (ft.)	
									10 ft.	30 ft.	50 ft.	70 ft.	90 ft.	110 ft.	130 ft.	150 ft.	170 ft.	190 ft.	210 ft.	220 ft.		240 ft.
810	1	1-1/4"	230	1	Non	20 ft.	15-1/4"	22-3/8"	15.3	14.2	13.2	12.3	11.5	10.5	9.6	8.7	--	--	--	--	--	150
815	2	1-1/4"	230	1	Non	20 ft.	15-1/4"	22-3/8"	15.3	14.2	13.2	12.3	11.5	10.5	9.6	8.7	7.8	6.8	5.7	5.0	4.0	240
									5 ft.	10 ft.	20 ft.	30 ft.	40 ft.	50 ft.	60 ft.	70 ft.	80 ft.	90 ft.	100 ft.	110 ft.	120 ft.	Shut Off (ft.)
803	1/2	1-1/4"	115, 230	1	Auto, Non	15 ft.	10-3/16"	14-3/32"	35	31	22	9	--	--	--	--	--	--	--	--	--	35
805	3/4	1-1/4"	115, 230	1	Auto, Non	15 ft.	10-3/16"	14-3/32"	40	37	29	20	8	--	--	--	--	--	--	--	--	45
807	1	1-1/4"	115, 230	1	Auto, Non	15 ft.	10-3/16"	14-3/32"	45	42	35	27	18	7	--	--	--	--	--	--	--	55
818	1	1-1/4"	115, 230, 200	1	Auto, Non	20 ft.	11-5/8"	18-5/8"	43	42	37	28	16.5	--	--	--	--	--	--	--	--	53
819	1-1/2	1-1/4"	230, 200	1	Auto, Non	20 ft.	11-5/8"	18-5/8"	43	43	43	42	39	32	22	12	--	--	--	--	--	81
820	2	1-1/4"	230, 200	1	Auto, Non	20 ft.	11-5/8"	18-5/8"	46	46	46	46	46	46	43	36	27	16.7	7	--	--	107
840	2	1-1/4"	230, 200, 460, 575	1, 3	Non	20 ft.	11-21/32"	24-7/32"	45	45	45	44	42	36	30	23	16	10	3	--	--	104
841	3	1-1/4"	230, 200, 460, 575	1, 3	Non	20 ft.	13-3/16"	22"	61	61	61	61	61	61	60	55	47	38	28	18	7	125
842	2	1-1/4"	230, 200, 460, 575	1, 3	Non	20 ft.	11-11/16"	23-3/4"	34	34	34	34	34	34	34	32	29	25	20	13	4	125
915	.5	1-1/4"	115	1	Auto	15 ft.	18"x30" Basin	32	27	13	--	--	--	--	--	--	--	--	--	--	--	26

\* Single Seal Units

- NOTES:
- BN/BE Models available packaged with a piggyback variable level float switch.
  - A double shaft seal available on 280, 290, 400 & 600 series.

# Technical Specs

## HAZARDOUS ENVIRONMENT

See FM2856

Model	HP	Discharge	Volts	Ph	Operation	Std. Cord Length	Width	Non Auto Height*	Gallons per minute (GPM) @ Height												Shut Off ft.
									5 ft.	10 ft.	15 ft.	20 ft.	25 ft.	30 ft.	40 ft.	50 ft.	60 ft.	70 ft.	80 ft.	90 ft.	
X161	1/2	1-1/2" 2" or 3"	115, 230, 200-208, 460, 575	1, 3	Auto/ NonAuto	20 ft.	13-5/16"	22"	100	93	85	79	70	62	45	20	--	--	--	--	56
X163	1/2	1-1/2" 2" or 3"	115, 230, 200-208, 460, 575	1, 3	Auto/ NonAuto	20 ft.	13-5/16"	22"	61	61	60	59	57	55	46	33	15	--	--	--	66
X165	1	1-1/2" 2" or 3"	230, 200-208, 460, 575	1, 3	Auto/ NonAuto	20 ft.	13-5/16"	22"	61	61	61	60	59	58	55	50	39	23	10	--	86.5
									5 ft.	10 ft.	20 ft.	30 ft.	40 ft.	50 ft.	60 ft.	70 ft.	80 ft.	90 ft.	100 ft.	110 ft.	
X185	1	1-1/2" 2" or 3"	230, 200-208, 460, 575	1, 3	Auto/ NonAuto	20 ft.	13-3/16"	22"	--	--	--	85	70	51	32	9	--	--	--	--	73
X186	1-1/2	1-1/2" 2" or 3"	200, 230, 460	1, 3	Auto/ NonAuto	20 ft.	13-3/16"	22"	58	58	58	58	58	58	58	52	45	30.5	16	4	114
X188	1-1/2	1-1/2" 2" or 3"	230, 200-208, 460, 575	1, 3	Auto/ NonAuto	20 ft.	13-3/16"	22"	145	140	128	116	103.5	90	71	51	28	2	--	--	91
X189	2	1-1/2" 2" or 3"	230, 200-208, 460, 575	1, 3	Auto/ NonAuto	20 ft.	13-3/16"	22"	145	140	130.5	120	109	97	85	69	51	34	17	--	110
									10 ft.	20 ft.	40 ft.	50 ft.	60 ft.	70 ft.	80 ft.	90 ft.	100 ft.	110 ft.	120 ft.	130 ft.	
X191	2	1-1/2" 2" or 3"	230	1	Auto/ NonAuto	20 ft.	13-3/16"	22"	45	45	45	45	45	45	45	45	40	30	20	10	137
									5 ft.	10 ft.	15 ft.	20 ft.	25 ft.	30 ft.	35 ft.	45 ft.	50 ft.	55 ft.	60 ft.	65 ft.	
X282	1/2	2" or 3"	115, 230, 200, 460, 575	1, 3	Auto/ NonAuto	20 ft.	13-9/16"	22-1/4"	127	96	64	34	6	--	--	--	--	--	--	--	26
X284	1	2" or 3"	230, 200, 460, 575	1, 3	Auto/ NonAuto	20 ft.	13-9/16"	22-1/4"	179	157	133	106	73	42	--	--	--	--	--	--	35
									5 ft.	10 ft.	15 ft.	20 ft.	25 ft.	30 ft.	40 ft.	50 ft.	60 ft.	70 ft.	80 ft.	90 ft.	
X292	1/2	2" or 3"	115, 230, 200, 460, 575	1, 3	Auto/ NonAuto	20 ft.	13-5/16"	22"	140	124	108	91	75	56	10	--	--	--	--	--	42
X293	1	2" or 3"	230, 200, 460, 575	1, 3	Auto/ NonAuto	20 ft.	13-5/16"	22"	--	--	118	108	96	82	48	--	--	--	--	--	50
X294	1-1/2	2" or 3"	230, 200, 460, 575	1, 3	Auto/ NonAuto	20 ft.	13-5/16"	22"	196	181	165	150	136	121	94	58	13	--	--	--	62
X295	2	2" or 3"	230, 200, 460, 575	1, 3	Auto/ NonAuto	20 ft.	13-5/16"	22"	214	199	184	168	154	140	115	89	59	23	--	--	75
									5 ft.	10 ft.	15 ft.	20 ft.	25 ft.	30 ft.	35 ft.	40 ft.	50 ft.	60 ft.	70 ft.	80 ft.	
X404	2	4"	230, 200, 460, 575	1, 3	NonAuto	20 ft.	16-1/8"	25-15/16"	300	265	224	184	134	60	--	--	--	--	--	--	33
X405	3	4"	230, 200, 460, 575	1, 3	NonAuto	20 ft.	16-1/8"	25-15/16"	361	326	284	241	197	134	50	--	--	--	--	--	38
									5 ft.	10 ft.	15 ft.	20 ft.	25 ft.	30 ft.	35 ft.	40 ft.	45 ft.	50 ft.	55 ft.	60 ft.	
X611	1	3" or 4"	230, 200, 460, 575	1, 3	NonAuto	25 ft.	17-9/16"	33-1/4"	255	190	110	35	--	--	--	--	--	--	--	--	22
X621	1-1/2	3" or 4"	230, 200, 460, 575	1, 3	NonAuto	25 ft.	17-9/16"	33-1/4"	340	277	215	143	72	--	--	--	--	--	--	--	29
X631	2	3" or 4"	230, 200, 460, 575	1, 3	NonAuto	25 ft.	17-9/16"	33-1/4"	385	330	275	220	150	80	--	--	--	--	--	--	35
X641	3	3" or 4"	230, 200, 460, 575	1, 3	NonAuto	25 ft.	17-9/16"	33-1/4"	480	430	380	325	270	208	143	72	--	--	--	--	44
X651	5	3" or 4"	230, 200, 460, 575	1, 3	NonAuto	25 ft.	17-9/16"	33-1/4"	575	533	490	440	390	335	280	220	150	80	--	--	55
X661	7-1/2	3" or 4"	230, 200, 460, 575	3	NonAuto	25 ft.	17-9/16"	33-1/4"	--	600	560	515	475	430	383	330	280	220	150	85	65

# Other fine Zoeller products . . .

## PACKAGE SYSTEMS

See FM2819

Model	Pumps Available	Volts	Basins Sizes Available	Check Valve Included	Assembled or Preassembled
<b>Simplex Systems</b>					
910	264, 267, 268	115, 230	18" x 30"	2" Cast Iron or PVC	Unassembled
912	211, 264, 266	115, 230	18" x 30", 24" x 24" 24" x 30", 24" x 30"	Not Included	Preassembled
<b>Duplex Systems</b>					
910	264, 267	115, 230	30" x 36"	2" Tri-Check®	Unassembled
<b>Preassembled Sewage System</b>					
912	211, 264, 266	115, 230	24" x 24"	Not Included	Preassembled
<b>Preassembled Grinder System</b>					
915	801, 803, 805, 807	115, 230	18" x 30", 24" x 24"	Included	Preassembled
922	820, 840	230/1 Ph - 460/3 Ph	24" x 36", 36" x 96"	Included	Preassembled
932	810	230/1 Ph	24" x 36", 36" x 96"	Included	Preassembled



Duplex Systems



Grinder Systems



Preassembled Systems

## POTABLE SYSTEMS

See FM2487

### Stainless Steel/Cast Iron "A" Series 4" Submersible Pumps

With models rated for small homes, cottages and light water usage demands as well as average residential home and family usage, this series of stainless steel pumps provides economical, quiet operation (see FM2489).

### Cast Iron Shallow Well and Deep Well Jet Pumps

Series of precision jet pumps designed to provide city water pressures for modern rural living (see FM2490).

### Irrigation Pumps

Provide up to 88 GPM (333 LPM) for moving large volumes of water quickly. Heavy duty, rugged construction (see FM1748).

### Centrifugal Pumps

Potable, multi-stage water pumps for high head applications. Designed for booster service, water circulation, cooling systems, laundry equipment and liquid transfer applications (see FM1734 and FM2526).



**For complete product  
information, visit:  
[www.zoeller.com](http://www.zoeller.com)**

# Other fine Zoeller products . . .

## ACCESSORIES and CONTROLS

See FM2819

### SmartPak Plus

This residential alternator system allows you to install two automatic pumps up to 1/2 HP, 115 V, 12 amps, single phase and alternate their use to provide extended pump life. The special design allows for use in humid areas such as basements, and the true alternation allows each pump to be used equally, not timed. The built-in alarm automatically sounds if one of the pumps should fail and calls for the second pump to run during a pump failure (see FM1663).

### Control Panels & Alarms

Zoeller offers a full line of controls and alarms specifically engineered to match our pumps and pump systems. From the most basic indoor alarm to highly advanced custom-built panels, we can meet virtually any specification. Standard simplex and duplex panel features include auto & manual run capabilities, high water alarm and remote monitoring contacts in both indoor and outdoor enclosures. Level sensing floats are included on most panels and alarms as an added value.

Electrical control panels used in simplex and duplex applications that require more than a preset integral or piggy-back float switch can provide. All weather enclosures, built-in alarm systems with remote capability, and manual run override are basic features on most units. Panels with intrinsically safe circuits are available for use with explosion-proof rated pumps in hazardous areas (see FM1596, FM0486, & FM1705).

### Float Switches

Zoeller has a full line offering of pump and control switches for pump up and down applications. Constructed of PVC/Poly and available in various lengths. Both mechanical and mercury models are available. UL listed (see FM0526 & FM0477).

### Check Valves

Zoeller check valves are quiet, reliable and efficient.

Whether a residential or commercial application, there is a correct Zoeller valve, including silent check valves, ball-check combinations, hi-temperature and much more. Our most popular residential valve #30-0181, has an angled internal flapper to eliminate water hammer, and the body is sonic welded to increase its life. Our cast iron threaded check valve can withstand up to 115' (35 m) of head. (see FM0217).

The Zoeller "Full-Flow" Unicheck features flexible neoprene slip x slip unions with all stainless steel clamps and screws. Saves installation time and is simple to install. No pipe threading required. Features an extra wide flapper hinge to prevent hinge stress. Can be installed in a vertical or horizontal line. Available in cast iron or PVC construction.

### Tri-Check® and The "Combo"

The Zoeller full flow Tri-Check® and "Combo" feature a threaded union that allows the pump to be removed without disrupting discharge piping. This saves time and money and is easy to install. The neoprene gasket and flapper are weighted with stainless steel backing plates and stainless steel rivets and can be installed on either a vertical or horizontal pipe (see FM0217).

### Flood Alert

The ultimate low water sensing alarm. Stainless steel sensors alert in as little as 1/32" (0.8 mm) of water. Operates on 3 AAA batteries and has low battery alert (see FM1617).

### Qwik-Box Pump Control and Alarm System

A junction connection box designed for easy hookup of pumps and alarm systems used in various applications requiring a connection outside the building or residence. Eliminates the need for junction wiring boxes inside sewage and septic tanks (see FM1420).

### Prewired Conduit and J-Box Assemblies

Prewired Conduit assemblies simplify the electrical portion of any pump job reducing the electrical job to only minutes. Flexible, watertight conduit and junction box assemblies (see FM2080 and FM1597).

### Disconnect and Rail Systems

Complete systems for sewage, effluent and grinder pumps can be field installed or factory installed in concrete, steel or fiberglass basins and tanks. Guide rails direct the pump to and from the base elbow (see FM0787).



Smart Pak Plus



Control Panels



Float Switches



Unichecks



Full Flow  
Check Valves



Flood Alert



Alarm Systems



Qwik-Box



Rail Systems





COMPANY

Zoeller Family of Water Solutions™

## ABOUT THE ZOELLER FAMILY OF WATER SOLUTIONS

Founded in 1939, Zoeller Company is one of the oldest independently-owned professional pump manufacturers in North America. Headquartered in Louisville, Kentucky USA, Zoeller has over 800 employees worldwide and close to 600,000 sq. ft. of manufacturing facilities from our seven operations in North America and Asia.

Zoeller Company has established itself as an innovative leader in pumping equipment and water treatment systems by continuous research and development. The quality of our products is demonstrated by UL, CSA, CE, and NSF listings as well as continued growth throughout the United States, Canada, Mexico, and over 40 other countries around the globe. The company has also expanded to include five brands, which have become the foundation of Zoeller.



The original Zoeller product line now resides in Zoeller Pump Company, which offers a broad range of submersible pumps from fractional to 7-1/2 HP for residential and commercial sump, effluent, dewatering and

grinding applications.



Flint & Walling, founded in 1866 in Kendallville, Indiana USA, is the only pump company in the U. S. to manufacture its own motor for jet and centrifugal pumps. This product line specializes in deep well pumps that range from 5

GPM to 1,000 GPM, as well as centrifugal, jet, booster, and submersible pumps up to 7-1/2 HP.



Founded in 1952, Wolf Pump is a manufacturer of submersible turbine pumps located in Abernathy, Texas. Wolf currently produces 4" to 8" pumps with capacities ranging from 35 to 1000 GPM. These pumps are known for their

efficiency and durability in demanding water applications including irrigation, municipal water supplies, dewatering applications, dairy production, mining, the oil and gas industries, aquaculture, and more.



Zoeller Engineered Products provides products for storm water removal, sewage pumping stations and hazardous environment

applications for residential, commercial and municipal markets. Available from 1/2 BHP to 100 BHP, each pump is customized by design, manufacture and installation according to exact application needs.



Clarus Environmental offers sustainable environmental products, solutions, and

services for the collection, treatment, and dispersal of residential and community wastewater. This line specializes in onsite pumps, pressure sewers, biological and mechanical treatment processes, disinfection, and discharge of safe water.

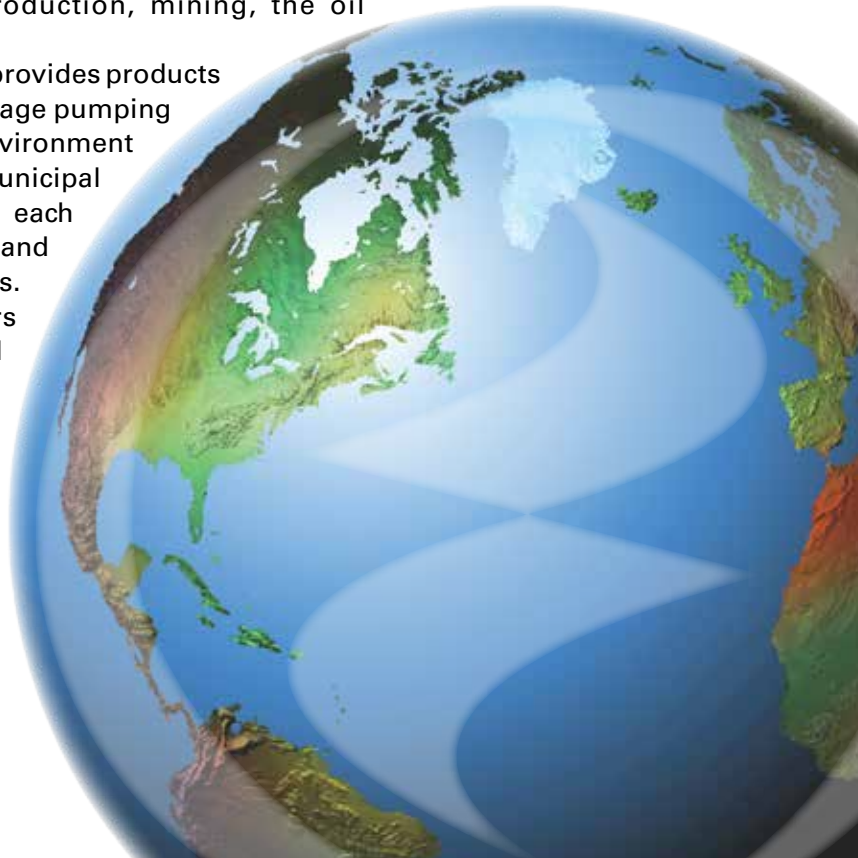

FM0532  
1116  
Supersedes  
0516



**PUMP COMPANY**

*Zoeller Family of Water Solutions™*

3649 Cane Run Road • Louisville, KY 40211 • 502-778-2731 • 1-800-928-7867 • [www.zoeller.com](http://www.zoeller.com)