

Pressure Washer Owner's Manual Manual del Propietario

WP2700
WP3000



KOHLER
ENGINES



You can be sure...if it's Westinghouse

**California
Proposition 65 Warning**

The engine exhaust from this product contains chemicals known to the state of California to cause cancer, birth defects or other reproductive harm.

**California
Proposition 65 Warning**

Certain components in this product and its related accessories contain chemicals known to the state of California to cause cancer, birth defects or other reproductive harm. Wash hands after handling.

DISCLAIMERS:

All information, illustrations and specifications in this manual are based on the latest information available at the time of publishing. The illustrations used in this manual are intended as representative reference views only. Moreover, because of our continuous product improvement policy, we may modify information, illustrations and/or specifications to explain and/or exemplify a product, service or maintenance improvement. We reserve the right to make any change at any time without notice.

ALL RIGHTS RESERVED:

No part of this publication may be reproduced or used in any form by any means – graphic, electronic or mechanical, including photocopying, recording, taping or information storage and retrieval systems – without the written permission of Westpro Power Systems, LLC.

CONGRATULATIONS ON OWNING A WESTINGHOUSE PRESSURE WASHER

⚠ DANGER



This manual contains important instructions for operating this pressure washer. For your safety and the safety of others, be sure to read this manual thoroughly before operating the pressure washer. Failure to properly follow all instructions and precautions can cause you and others to be seriously hurt or killed.

For Your Records

Date of Purchase: _____ Pressure Washer Model Number: _____

Purchased from Store/Dealer: _____ Pressure Washer Serial Number: _____

Purchase Receipt: (retain your purchase receipt to ensure trouble-free warranty coverage)

Product Registration

To ensure trouble-free warranty coverage, it is important you register your Westinghouse pressure washer. You can register your pressure washer by either:

1. Filling in the product registration form below and mailing to:

Product Registration
Westpro Power Systems, LLC
W237 N2889 Woodgate Road, Unit B
Pewaukee, WI 53072

2. Registering your product online at www.westpropower.com/register.iml

To register your pressure washer you will need to locate the following information:

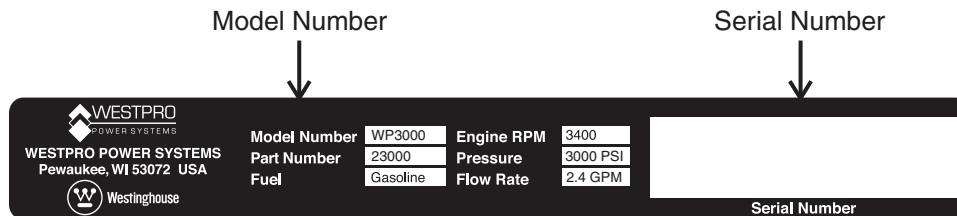

Product Registration Form

PERSONAL INFORMATION

First Name: _____
 Last Name: _____
 Street Address: _____
 Street Address: _____
 City, State, ZIP: _____
 Country: _____
 Phone Number: _____
 E-Mail: _____

PRESSURE WASHER INFORMATION

Model Number: _____
 Serial Number: _____
 Date Purchased: _____
 Purchased From: _____

TABLE OF CONTENTS

CONGRATULATIONS ON OWNING A WESTINGHOUSE PRESSURE WASHER	3
For Your Records	3
Product Registration	3
Product Registration Form.....	3
SAFETY	7
SAFETY DEFINITIONS	7
SAFETY SYMBOL DEFINITIONS	7
GENERAL SAFETY RULES	8
SAFETY LABELS AND DECALS	10
WP2700.....	10
WP3000.....	11
UNPACKING	12
UNPACKING THE PRESSURE WASHER	12
COMPONENTS	12
ASSEMBLY	13
ASSEMBLY	13
FEATURES	17
GENERAL PRESSURE WASHER FEATURES.....	17
WP2700.....	17
WP3000.....	19
OPERATION	21
BEFORE STARTING THE PRESSURE WASHER	21
ADDING / CHECKING ENGINE FLUIDS AND FUEL.....	21
Checking and / or Adding Engine Oil.....	21
Adding Gasoline to the Fuel Tank.....	22
CONNECTING THE WATER SUPPLY	22
STARTING THE PRESSURE WASHER	23
STOPPING THE PRESSURE WASHER	25
Normal Operation	25
During an Emergency.....	26
SELECTING NOZZLES	26
Changing the Nozzle	27
SPRAYING TIPS	27
SPRAYING SOAP	28
RINSING	28
CLEANING SOAP SIPHON HOSE.....	28
MAINTENANCE	29
MAINTENANCE	29
Maintenance Schedule	29
Model WP2700.....	30
Model WP3000.....	30
ENGINE OIL MAINTENANCE	31
Engine Oil Specification.....	31
Checking Engine Oil	31
Model WP2700.....	31
Model WP3000.....	31
Adding Engine Oil.....	32
Changing Engine Oil.....	32
Model WP2700.....	32
Model WP3000.....	33
AIR FILTER MAINTENANCE	33
Model WP2700	33
Model WP3000	34
SPARK PLUG MAINTENANCE	35
PRESSURE WASHER COMPONENTS	36
Water Filter Screen.....	36

TABLE OF CONTENTS

High-Pressure Hose and Spray Gun	36
High-Pressure Hose	36
Spray Gun	36
Soap Siphon Hose.....	37
Nozzle.....	37
AFTER EACH USE	37
LONG-TERM STORAGE	38
Storage Procedure for 1 – 3 Months.....	38
Storage Procedure for Greater Than 3 Months	38
WINTER STORAGE.....	38
Remove and Install the Pump – WP2700.....	38
Remove and Install the Pump – WP3000.....	39
TROUBLESHOOTING	40
TROUBLESHOOTING	40
WARRANTY	42
WESTPRO POWER SYSTEMS “THREE YEAR” LIMITED WARRANTY	42
WESTPRO’S RESPONSIBILITY.....	42
OWNER’S RESPONSIBILITY	42
PRODUCT WARRANTY APPLICATIONS AND PRODUCT WARRANTY PERIODS	42
CONSUMER APPLICATION.....	42
COMMERCIAL APPLICATION	42
EXCLUSIONS.....	43
DISCLAIMER OF IMPLIED WARRANTIES.....	43
EMISSIONS CONTROL WARRANTY	44
FEDERAL AND/OR CALIFORNIA EMISSION CONTROL WARRANTY STATEMENT.....	44
YOUR WARRANTY RIGHTS AND OBLIGATIONS	44
MANUFACTURER’S WARRANTY COVERAGE:	44
OWNER’S WARRANTY RESPONSIBILITIES:.....	44
DEFECTS WARRANTY REQUIREMENTS.....	44
WARRANTED PARTS:	45
QUESTIONS:.....	46

SAFETY DEFINITIONS

The words DANGER, WARNING, CAUTION and NOTICE are used throughout this manual to highlight important information. Be certain that the meanings of these alerts are known to all who work on or near the equipment.



This safety alert symbol appears with most safety statements. It means attention, become alert, your safety is involved! Please read and abide by the message that follows the safety alert symbol.

DANGER

Indicates a hazardous situation which, if not avoided, *will* result in death or serious injury.

WARNING

Indicates a hazardous situation which, if not avoided, *could* result in death or serious injury.

CAUTION



Indicates a hazardous situation which, if not avoided, *could* result in minor or moderate injury.

NOTICE

Indicates a situation which can cause damage to the pressure washer, personal property and/or the environment, or cause the equipment to operate improperly.

NOTE: Indicates a procedure, practice or condition that should be followed in order for the pressure washer to function in the manner intended.

SAFETY SYMBOL DEFINITIONS

Symbol	Description
	Safety Alert Symbol
	Asphyxiation Hazard
	Burn Hazard (Chemical)

Symbol	Description
	Burn Hazard
	Burst/Pressure Hazard
	Don't leave tools in the area
	Electrical Shock Hazard
	Explosion Hazard
	Fall Hazard
	Fire Hazard
	High-Pressure Hazard
	Lifting Hazard
	Pinch-Point Hazard
	Read Manufacturer's Instructions
	Read Safety Messages Before Proceeding
	Wear Personal Protective Equipment (PPE)

SAFETY

GENERAL SAFETY RULES

DANGER



NEVER operate the pressure washer in an enclosed area. Engine exhaust contains carbon monoxide. Only operate the pressure washer outside and away from windows, doors and vents.

WARNING



Gasoline and gasoline vapors are extremely flammable and explosive under certain conditions.









- **ALWAYS** refuel the pressure washer outdoors, in a well-ventilated area.
- **NEVER** remove the fuel cap with the engine running.
- **NEVER** refuel the pressure washer while the engine is running. Always turn engine off and allow the pressure washer to cool before refueling.
- Only fill fuel tank with gasoline.
- Keep sparks, open flames or other form of ignition (such as match, cigarette, static electric source) away when refueling.
- **NEVER** overfill the fuel tank. Leave room for fuel to expand. Overfilling the fuel tank can result in a sudden overflow of gasoline and result in spilled gasoline coming in contact with **HOT** surfaces. Spilled fuel can ignite. If fuel is spilled on the pressure washer, wipe up any spills immediately. Dispose of rag properly. Allow area of spilled fuel to dry before operating the pressure washer.
- Wear eye protection while refueling.
- **NEVER** use gasoline as a cleaning agent.
- Store any containers containing gasoline in a well-ventilated area, away from any combustibles or source of ignition.
- Check for fuel leaks after refueling. Never operate the engine if a fuel leak is discovered.

WARNING



This equipment produces a stream of water with enough high pressure to penetrate skin and its underlying tissues, which could result in amputation or other serious injury. Spray gun traps high-pressure water, even when engine is stopped and water is disconnected. Leaks caused by loose fittings or worn or damaged hoses can result in injection injuries. **DO NOT TREAT FLUID INJECTION AS A SIMPLE CUT!** See a physician immediately!



- **NEVER** aim spray gun at people, animals or plants. Direct spray away from self and others.
- **NEVER** place hands in front of nozzle.
- **ALWAYS** point spray gun in safe direction while spraying and when relieving retained high pressure after stopping engine.
- **DO NOT** allow **CHILDREN** to operate pressure washer.
- **NEVER** leave spray gun unattended while machine is running.
- **NEVER** secure spray gun in open position.
- **DO NOT** twist nozzle while spraying.
- **NEVER** repair a high-pressure hose. **ALWAYS** replace it.
- **NEVER** repair leaking connections with sealant of any kind. **ALWAYS** use factory-recommended repair parts.
- **NEVER** hold onto the hose or fittings during operation.
- **DO NOT** allow high-pressure hose to contact muffler or other extremely hot surfaces.
- **ALWAYS** be certain spray gun, nozzles and hoses are correctly attached and in working order.
- **NEVER** use spray gun if trigger lock is not in working order.
- **ALWAYS** use spray gun, hoses and connections rated for pressure higher than your pressure washer's psi.
- **NEVER** attach or remove spray gun, nozzles or hoses while system is pressurized.

 WARNING	
	<ul style="list-style-type: none"> • NEVER modify spray equipment. • ALWAYS wear protective clothing to protect eyes and skin from contact with sprayed materials.
	NEVER aim spray in the direction of power source. Contact with power source can cause electric shock or burn.
	<p>Unexpected kickback while spraying can cause you to fall.</p> <ul style="list-style-type: none"> • Use of pressure washer can create slippery surfaces and puddles. The operating area of this equipment should have adequate drainage to reduce the possibility of a fall due to slippery surfaces. • Be extremely careful if necessary to use the pressure washer from a ladder, scaffolding or any other similar location. • Use both hands to firmly grasp the spray gun while in use to avoid injury from high-pressure kickback.
	NEVER use acids, toxic or corrosive chemicals, poisons, insecticides, or any kind of flammable solvent with this equipment. Only use detergents, cleaners and degreasers recommended for use in this pressure washer.
	ALWAYS wear chemical splash safety goggles that comply with ANSI Z87.1 when operating or in the vicinity of this equipment.
	ALWAYS remove any tools or other service equipment used during maintenance from the pressure washer before operating.

NOTICE
<p>NEVER operate pressure washer with damaged or missing parts.</p> <p>NEVER modify any feature or component of pressure washer.</p> <p>NEVER spray at glass when using the high-pressure nozzle (red). High-pressure spray may damage fragile items including glass.</p> <p>DO NOT exceed rated pressure when operating pressure washer.</p> <p>NEVER move pressure washer by pulling on any hoses. Always use handle to move pressure washer.</p> <p>Check components for ice forming on components when operating in cold weather.</p> <p>Remove the protective shipping caps from the pump's water inlet and outlet.</p> <p>Be sure the water supply is connected and turned on before starting the engine. Damage to the pump could occur and will void the warranty.</p> <p>Water supply must deliver a minimum of 3.8 gal (14.3 L) per minute and at least 30 psi (2 bar). Do not siphon standing water for the water supply. Water temperature must not exceed 100°F (37.7°C).</p> <p>DO NOT install a one-way valve, vacuum breaker or check valve at the pump's water inlet. Installing one of these devices at the pump's water inlet could cause damage to the pump and will void the warranty. Allow at least 10 feet (3 m) of unrestricted hose length between the pump's water inlet and a one-way valve, vacuum breaker or check valve.</p>

UNPACKING

UNPACKING THE PRESSURE WASHER

⚠ CAUTION	
	Always have assistance when lifting the pressure washer. The pressure washer is heavy; lifting it could cause bodily harm.
	Avoid cutting on or near staples to prevent personal injury.

The following tools are required:

- Box cutter or similar device
- 10 mm wrench

1. Carefully cut the packing tape on top of the carton.
2. Fold back top flaps to reveal the owner's manual. Remove owner's manual and save it for reference.
3. Carefully cut two sides of the carton to remove the pressure washer.

COMPONENTS

Verify the contents against the list below. If any parts are missing, please locate an authorized Westinghouse dealer at www.westpropower.com or call 1-855-WHHELP1 (1-855-944-3571).



Figure 3 – Unpacking

- | | |
|----------------------------|-------------------|
| 1 - Spray Wand (1) | 4 - Soap Hose (1) |
| 2 - High-Pressure Hose (1) | 5 - Spray Gun (1) |
| 3 - Wheels (2) | |

NOTE: A 0.6-liter bottle of SAE 10W30 oil is also included. Soap reservoir is not included.



Figure 4 – Hardware

- | | |
|---|--|
| 1 - Hose Bracket Nuts M6 (2) | 6 - Wheel Axle Lock Pin (2) |
| 2 - Wheel Axle Pin 16 mm x 105 mm (2) | 7 - Wheel Axle Washer (2) |
| 3 - Spray Gun Bracket | 8 - Hose Bracket |
| 4 - Spray Gun Bracket Nuts M6 (2) | 9 - Front Support – WP3000 only |
| 5 - Spare Parts: High-Pressure Hose O-Rings (2) Inlet Screens (2) | 10 - Front Support Nuts M6 (2) – WP3000 only |

ASSEMBLY



Before assembling the pressure washer, review *Safety on page 7* and the following safety messages.

CAUTION



Never lift the pressure washer without assistance. The pressure washer is heavy and lifting without assistance could result in personal injury.



Never use the handles as a lifting point to support the entire weight of the pressure washer. Only use the handles to move the pressure washer by lifting the handles and using the wheels to move the pressure washer.



Use caution when collapsing the handles. Hands and fingers could get caught and pinched.

NOTICE

Assembling the pressure washer will require tipping the unit. Make sure all engine oil and fuel are drained from the unit prior to assembling.

Once assembled, the wheels are not intended for on-road use. The wheels are designed for use on this pressure washer only.

Never tip the pressure washer after it has been fully assembled and filled with oil and fuel.

1. Place pressure washer on a flat surface.

2. Push the lock pin in and raise the handle (see *Figure 5*).



Figure 5 – Raising Handle

3. Be sure the handle is locked in position with the pin protruding through handle hinge (see *Figure 6*).



Figure 6 – Raising Handle

ASSEMBLY

- Slide the wheel axle washer onto the wheel axle pin (see Figure 7).

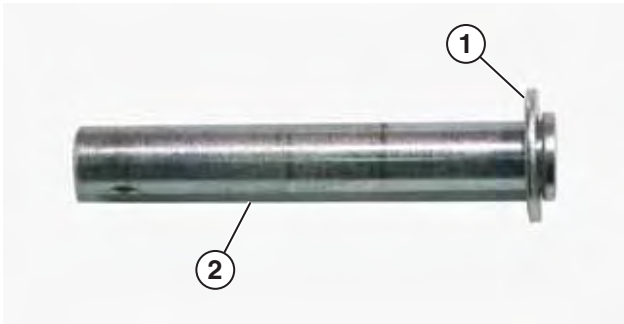

Figure 7 – Installing Wheel Axle Washer

- 1 - Wheel Axle Washer 2 - Wheel Axle Pin Washer

- Install the pin into the wheel assembly.
- Locate the wheel axle mounting holes (see Figure 8). Install the pin through the axle mounting holes.



Figure 8 – Wheel Axle Mounting Holes

- Secure the wheel axle pin in position with the wheel axle lock pin (see Figure 9).



Figure 9 – Installing Wheel Axle Lock Pin

- WP3000 only – Install the front support using the two front support nuts (M6). Tighten the nuts securely (see Figure 10).



Figure 10 – Installing Front Support

- 1 - Front Support 2 - Front Support Nuts (M6)

9. Install the spray gun bracket using the two spray gun bracket nuts (M6). Tighten the nuts securely (see Figure 11).

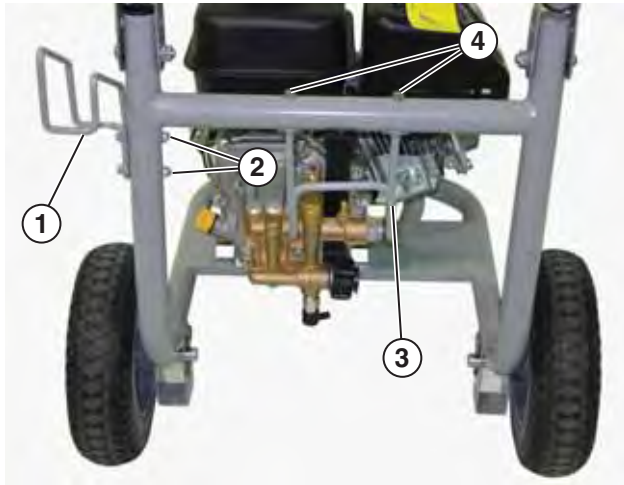

Figure 11 – Installing Spray Gun Bracket and Hose Bracket

- | | |
|---------------------------------|----------------------------|
| 1 - Spray Gun Bracket | 3 - Hose Bracket |
| 2 - Spray Gun Bracket Nuts (M6) | 4 - Hose Bracket Nuts (M6) |

10. Install the hose bracket using the two hose bracket nuts (M6). Tighten the nuts securely (see Figure 11).
11. Connect the wand to the spray gun and turn the fitting counterclockwise to tighten (see Figure 12). Do not overtighten. The fitting only needs to be hand-tight.

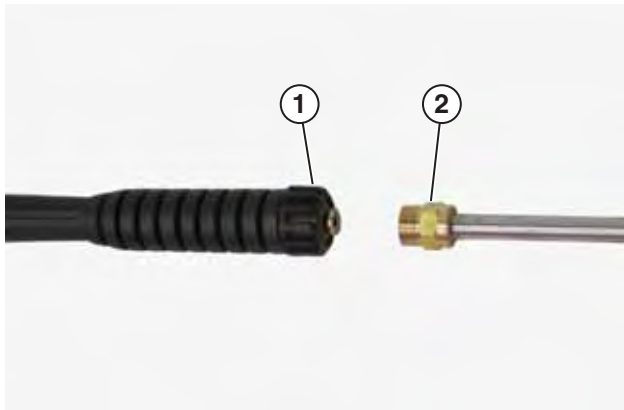

Figure 12 – Connecting Spray Wand

- | | |
|-------------|----------------|
| 1 - Fitting | 2 - Spray Wand |
|-------------|----------------|

12. Inspect the O-rings on both sides of the high-pressure hose. Moisten the O-rings with water (see Figure 13).



Figure 13 – High-Pressure Hose O-Rings

13. Connect the high-pressure hose to the pump and tighten the hose fitting (see Figure 14 and Figure 15). Do not overtighten. The fitting only needs to be hand-tight.

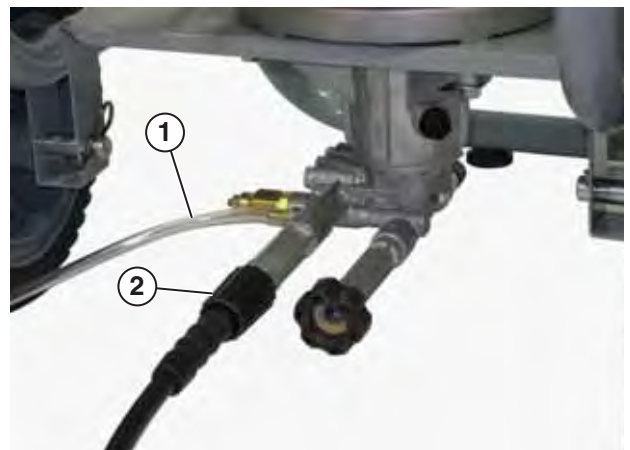

Figure 14 – Installing High-Pressure Hose – WP2700

- | | |
|---------------|------------------|
| 1 - Soap Hose | 2 - Hose Fitting |
|---------------|------------------|

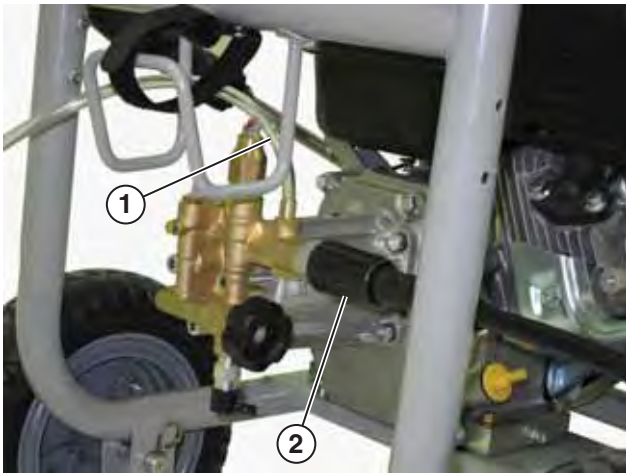

Figure 15 – Installing High-Pressure Hose – WP3000

1 - Soap Hose 2 - Hose Fitting

14. Connect the soap hose to the barbed fitting if you are going to be using soap (see Figure 14 and Figure 15).
15. Flip the trigger lock up to lock the trigger in the **OFF** position (see Figure 16).

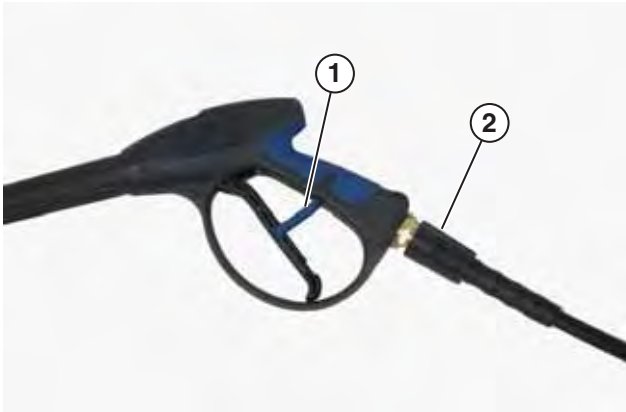

Figure 16 – Trigger Lock in OFF Position

1 - Trigger Lock 2 - Hose Fitting

16. Install the high-pressure hose to the spray gun and tighten the hose fitting (see Figure 16). Do not overtighten. The fitting only needs to be hand-tight.

GENERAL PRESSURE WASHER FEATURES

WP2700



Figure 17

- | | |
|-----------------------|----------------------------------|
| 1 - ON/OFF Switch | 5 - Water Inlet Fitting |
| 2 - Starter Handle | 6 - High-Pressure Outlet Fitting |
| 3 - Spray Gun Bracket | 7 - Choke Lever |
| 4 - Hose Bracket | 8 - Air Cleaner |

FEATURES

WP2700



Figure 18

- 1 - Spray Gun
- 2 - Nozzle Storage
- 3 - Fuel Cap
- 4 - Engine Oil Fill Plug/Dipstick
- 5 - Spark Plug
- 6 - Oil Drain Plug
- 7 - High-Pressure Hose

WP3000



Figure 19

- 1 - ON/OFF Switch
- 2 - Fuel Cap
- 3 - Spray Gun Bracket
- 4 - Hose Bracket
- 5 - High-Pressure Hose
- 6 - Engine Oil Fill Plug/Dipstick
- 7 - Oil Drain Plug

FEATURES

WP3000



Figure 20

- 1 - Spark Plug
- 2 - Nozzle Storage
- 3 - Air Cleaner
- 4 - Throttle Lever
- 5 - Starter Handle
- 6 - Fuel Shutoff Lever
- 7 - Choke Lever
- 8 - Water Inlet Fitting
- 9 - High-Pressure Outlet Fitting

BEFORE STARTING THE PRESSURE WASHER



Before starting the pressure washer, review *Safety on page 7*.

Location Selection – Before starting the pressure washer, avoid exhaust and location hazards by verifying the following:

- You have selected a location to operate the pressure washer that is outdoors and well ventilated.
- You have selected a location with adequate drainage but still level enough to prevent the pressure washer from tipping over.
- You have selected a location that is at least 5 feet (1.5 m) away from any building, other equipment or combustible material.
- If the pressure washer is located close to a building, make sure it is not located near any windows, doors and/or vents.

WARNING



Always operate the pressure washer on a surface that will prevent the pressure washer from tipping over. Placing the pressure washer on a surface that may allow the pressure washer to tip over, could cause fuel and oil to spill. Spilled fuel can ignite if it comes in contact with an ignition source such as a very hot surface.

NOTICE

Operating the pressure washer on a surface with loose material such as sand or grass clippings can cause debris to be ingested by the pressure washer that could:

- Block cooling vents
- Block air intake system

Check the following items before starting the engine:

1. Verify the pressure washer is properly assembled.
2. Check that recommended engine oil has been added to proper level in the engine crankcase.
3. Add recommended fuel to fuel tank.
4. Check for properly tightened hose connections.
5. Check to make sure there are no kinks, cuts or damage to high-pressure hose.
6. Provide a proper water supply at an adequate flow.

ADDING / CHECKING ENGINE FLUIDS AND FUEL



Before adding/checking engine fluids and fuel, review *Safety on page 7*.

DANGER



Filling the fuel tank with gasoline while the pressure washer is running can cause gasoline to leak and come in contact with hot surfaces that can ignite the gasoline.

Before starting the pressure washer, always check the level of:

- Engine oil
- Gasoline in the fuel tank

Once the pressure washer is started and the engine gets warm, it is not safe to add gasoline to the fuel tank or engine oil to the engine while the engine is running or the engine and muffler are hot.

Checking and / or Adding Engine Oil

WARNING



Internal pressure can build in the engine crankcase while the engine is running. Removing the oil fill plug/dipstick while the engine is hot can cause extremely hot oil to spray out of the crankcase and can severely burn skin. Allow engine oil to cool for several minutes before removing the oil fill plug/dipstick.

The unit as shipped does not contain oil in the engine. You must add engine oil before starting the pressure washer for the first time. Use the entire supplied 0.6-liter container of engine oil. See *Checking Engine Oil on page 31* and *Adding Engine Oil on page 32* for instructions on checking engine oil level and the procedure for adding engine oil.

NOTICE

The pressure washer does not contain engine oil as shipped. Attempting to start the engine without adding engine oil can permanently damage internal engine components.

OPERATION

Adding Gasoline to the Fuel Tank

WARNING



Never refuel the pressure washer while the engine is running.



Always turn the engine off and allow the pressure washer to cool before refueling.

Required Gasoline – Only use gasoline that meets the following requirements:

- Unleaded gasoline only
- Gasoline with maximum 10% ethanol added
- Gasoline with an 87 octane rating or higher

Filling the Fuel Tank – Follow the steps below to fill the fuel tank:

1. Shut off the pressure washer.
2. Allow the pressure washer to cool down so all surface areas of the muffler and engine are cool to the touch.
3. Move the pressure washer to a flat surface.
4. Clean area around the fuel cap.
5. Remove the fuel cap by rotating counterclockwise.
6. Slowly add gasoline into the fuel tank. Be very careful not to overfill the tank. The gasoline level should NOT be higher than the bottom of the filler neck.

NOTICE

Take care when installing the fuel cap. Threads can be damaged if cap is incorrectly installed.

7. Install the fuel cap by rotating clockwise until it hits the stop, indicating the cap is completely installed.

CAUTION



Avoid prolonged skin contact with gasoline. Avoid prolonged breathing of gasoline vapors.

CONNECTING THE WATER SUPPLY

NOTICE

Do not start the engine without the water supply connected and turned on. Running the pump without water will damage the pump.

Water supply must deliver a minimum of 3.8 gal (14.3 L) per minute and at least 30 psi (2 bar). Do not siphon standing water for the water supply. Water temperature must not exceed 100°F (37.7°C).

1. Run water through your garden hose to clear out any debris that may have been in the hose.
2. Inspect the water inlet screen to make sure it is in place and free of debris (*see Figure 21 and Figure 22*). Do not operate the pressure washer with a missing or damaged inlet screen.

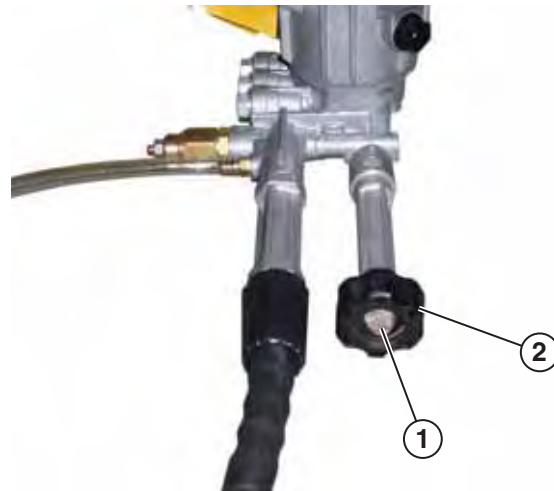

Figure 21 – Water Connection – WP2700

1 - Water Inlet Screen

2 - Water Inlet Fitting

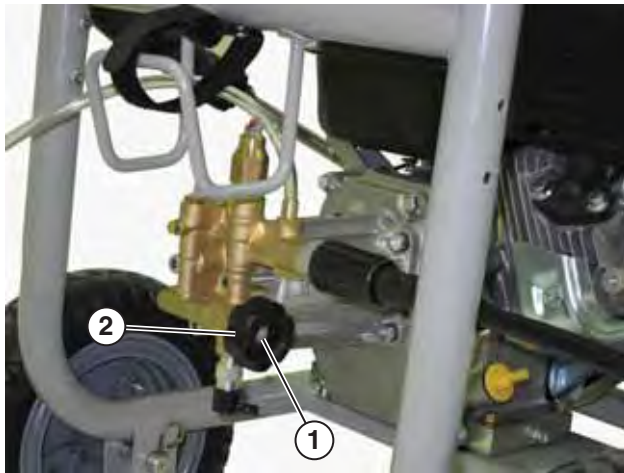

Figure 22 – Water Connection – WP3000

1 - Water Inlet Screen

2 - Water Inlet Fitting

NOTICE

Make sure water inlet screen is in place before attaching hose.

3. Use the shortest hose possible to complete the job at hand. Using a longer hose may affect performance. Connect a garden hose that is not longer than 50 feet (15.2 m) to the water inlet fitting (see Figure 21 and Figure 22).
4. Tighten the fitting onto the hose.
5. Turn the water on and inspect for leaks.
6. Squeeze the trigger on the gun and allow any air to bleed out of the hoses and the pump before starting the engine.
7. Connect the soap hose to the soap bottle if using soap.

STARTING THE PRESSURE WASHER



Before starting the pressure washer, review *Safety on page 7*.

NOTE: Pressure washer may walk or move when used on hard surfaces. Be sure the unit is secure during operation.

Before attempting to start the pressure washer, verify the following:

- The engine is filled with engine oil (see *Checking Engine Oil on page 31*).
- The pressure washer is situated in a proper location (see *Location Selection on page 21*).



DANGER



Never operate the pressure washer in an enclosed area. Engine exhaust contains carbon monoxide that can kill in minutes. Only operate the pressure washer outside and away from windows, doors and vents.

1. Flip the trigger lock lever up and lock the trigger in the **OFF** position (see Figure 23).



Figure 23 – Trigger Lock Lever

2. Make sure the water supply is turned on.

OPERATION

NOTE: The pump is equipped with a thermo valve (see Figure 24 and Figure 25). If the pump is run for an extended period of time without water flowing through it, it could overheat. If the pump gets to a certain temperature, the thermo valve will open and discharge warm water out the valve to allow cold water in to cool the pump.

3. Point the thermo valve away from the work area you are washing to avoid being sprayed with warm water.



Figure 24 – Pump Thermo Valve – WP2700

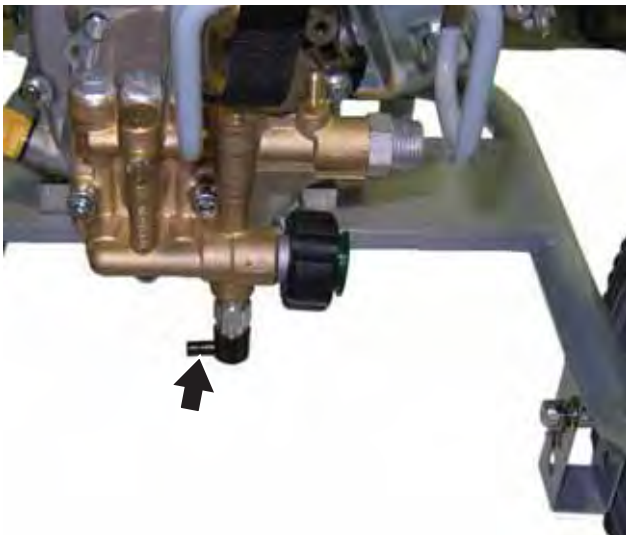

Figure 25 – Pump Thermo Valve – WP3000

4. WP2700 – Move the engine ON/OFF switch to the **ON (I)** position (see Figure 26). Move the choke lever to the choke position.

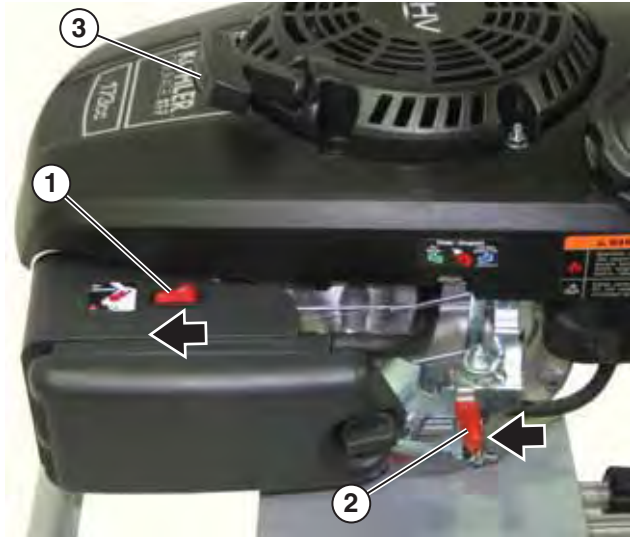

Figure 26 – Engine ON/OFF Switch – WP2700

- | | |
|--------------------------|---------------------------|
| 1 - Engine ON/OFF Switch | 3 - Starter Handle Switch |
| 2 - Choke Lever | |

5. WP3000 – Move the engine ON/OFF switch to the **ON** position (I) (see Figure 27).



Figure 27 – Engine ON/OFF Switch – WP3000

- WP3000 – Move the throttle lever to the full throttle position (see Figure 28). Move the choke lever to the choke position. Open the fuel shutoff valve.

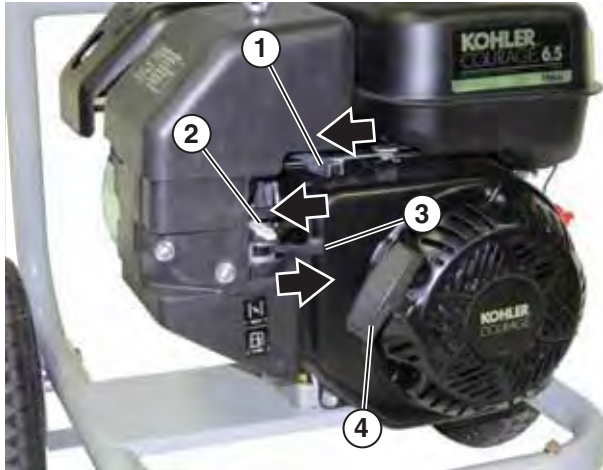

Figure 28 – Throttle Lever, Choke Lever, Fuel Shutoff Valve

- | | |
|--------------------|------------------------|
| 1 - Throttle Lever | 3 - Fuel Shutoff Valve |
| 2 - Choke Lever | 4 - Starter Handle |

- Firmly grasp and pull the starter handle slowly until you feel increased resistance. At this point, apply a rapid pull on the starter handle.

NOTE: If the engine starts briefly and then shuts off, squeeze the trigger on the spray gun to relieve the pressure before trying to start the engine again.

- Once the engine starts, move the choke lever to the open position. Allow the engine to warm up slightly before beginning washing.

NOTE: WP3000 – Always operate the engine at full throttle position when washing.

STOPPING THE PRESSURE WASHER

Normal Operation

During normal operation, use the following steps to stop your pressure washer:

- Lock the spray gun trigger lock in the **OFF** position.
- Move the engine ON/OFF switch to the **OFF (O)** position (see Figure 29 and Figure 30).



Figure 29 – Engine ON/OFF Switch OFF Position – WP2700



Figure 30 – Engine ON/OFF Switch OFF Position – WP3000

OPERATION

- WP3000 – Close the fuel shutoff valve (see Figure 31).



Figure 31 – Closing Fuel Shutoff Valve – WP3000

- Turn the water supply off.
- Unlock the spray gun trigger and squeeze the trigger to release any pressure in the hoses and pump.
- Disconnect the garden hose from the water inlet.

During an Emergency

If there is an emergency and the pressure washer must be stopped quickly, push the engine control switch to the **OFF** (O) position immediately.

SELECTING NOZZLES

The quick-connect feature allows changing between nozzles while the pressure washer is running once the spray gun trigger is locked in the safe position.

NOTICE

Only use the nozzles that were supplied with the pressure washers. Using any other nozzles can affect performance and may void the warranty. For replacement nozzles go to www.westpropower.com or call (855) 944-3571.

WARNING



Always apply the trigger lock to change a nozzle if the engine is running.

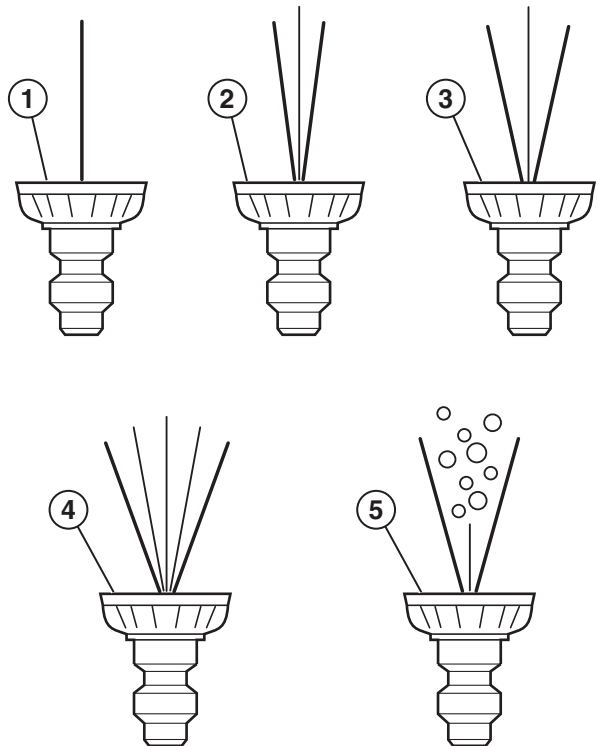

Figure 32 – Nozzle Spray Pattern

- | | |
|--|----------------------------|
| 1 - Red High Pressure 0° | 4 - White Low Pressure 40° |
| 2 - Yellow High to Medium Pressure 15° | 5 - Black Soap |
| 3 - Green Medium Pressure 25° | |

Table 1: Nozzles

Nozzle	Use
1. High Pressure Nozzle (Red) – higher pressure and smallest spray pattern NOTICE: The red nozzle can damage surfaces if it is held too close for an extended time	Use to clean hard, embedded dirt and grime. Use on concrete, brick, driveways and patios.
2. High to Medium Pressure Nozzle (Yellow) – high to medium pressure with smallest angle spray pattern	Use to clean paint, stain, mildew, oil, and compacted dirt and grime. Use on wood decks, home siding, driveways and patios.
3. Medium Pressure Nozzle (Green) – medium pressure and medium spray pattern	Use to clean paint, stain, mildew, oil, and compacted dirt and grime. Use on wood decks, home siding, driveways and patios.
4. Low Pressure Nozzle (White) – lower pressure and widest spray pattern	Use to clean general loose dirt and grime. For use on most surfaces including cars, wood decks, patios, outdoor furniture, home siding, and lawn and garden equipment.
5. Soap Nozzle (Black) NOTICE: Only use pressure washer–safe soap.	Use to apply soap to cleaning surfaces in order to provide a thorough cleaning.

Changing the Nozzle

1. Push up the trigger lock to lock it in the **OFF** position (see Figure 33).



Figure 33 – Trigger Lock Locked

2. Pull the quick coupler toward the spray gun (see Figure 34).

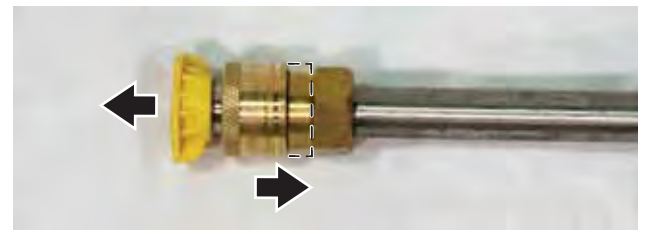

Figure 34 – Installing a Nozzle

3. Push the nozzle into the coupler and push the coupler away from the spray gun (see Figure 34). The nozzle will lock into place. Tug on the nozzle to verify it is locked in place.

SPRAYING TIPS

For most cleaning, keep nozzle 8 – 24 in. (20 – 61 cm) away from cleaning surface.

- Damage may occur to the cleaning surface if you spray too close, especially with high-pressure nozzles.
- When you begin spraying, start farther away and move closer to avoid damage to the surface.
- When cleaning tires, allow at least 6 in. (15 cm) between a tire and the nozzle.

NOTICE

Do not get any closer than 6 in. (15 cm). Spraying closer than 6 in. (15 cm) may damage tire.

To relieve system pressure, shut off engine, turn off water supply and pull gun trigger until water stops flowing.

OPERATION

SPRAYING SOAP

NOTICE

Only use pressure washer–safe soap.

1. Install the soap nozzle (black).

NOTICE

Only use the soap nozzle to apply soap. Using other nozzles will not apply soap.

2. Prepare soap solution following manufacturer's instructions.
3. Place soap siphon hose into soap container.

NOTICE

Do not route soap siphon hose where it can contact the muffler while the engine is running.

4. Make sure the garden hose and high-pressure hose are connected.

NOTICE

All hoses must be connected before starting the engine.

5. Turn on the water supply.
6. Start the engine and squeeze the trigger.
7. Use long, even overlapping stroke to apply soap.
8. Allow 3 – 5 minutes for the soap to soak in before washing and rinsing. Do not allow the soap to dry on the surface before rinsing. Reapply soap if necessary to maintain a wet surface for the soap to soak in.

NOTICE

Clean the soap siphon hose once done. See *Cleaning Soap Siphon Hose on page 28*.

RINSING

WARNING



Always apply the trigger lock to change a nozzle if the engine is running.

1. Select the desired nozzle and change nozzle. See *Selecting Nozzles on page 26*.
2. Squeeze the trigger and carefully start to spray, keeping nozzle a safe distance from the cleaning surface.
3. Starting from the top of the surface, spray a small area then check surface for damage. If no damage, continue rinsing by using overlapping strokes working down the surface. Keep checking surface for damage while rinsing.

CLEANING SOAP SIPHON HOSE

If used, clean the soap siphon hose before stopping the engine.

1. If necessary, install the soap nozzle (black).
2. Use clean water to flush the soap siphon hose. Submerge the soap siphon hose in the clean water.
3. Flush the soap siphon hose for 1 – 2 minutes while the engine is running.
4. Once clean, stop the engine.
5. Point spray gun in a safe direction. Squeeze the trigger to release pressure within the system.

MAINTENANCE



Before performing maintenance on the pressure washer, review *Safety on page 7* and the following safety messages.

WARNING



Avoid accidentally starting the pressure washer during maintenance by removing the spark plug boot from the spark plug.



Allow hot components to cool to the touch prior to performing any maintenance procedure.



Internal pressure can build in the engine crankcase while the engine is running. Removing the oil fill plug/dipstick while the engine is hot can cause extremely hot oil to spray out of the crankcase and can severely burn skin. Allow engine oil to cool for several minutes before removing the oil fill plug/dipstick.



Always perform maintenance in a well-ventilated area. Gasoline fuel and fuel vapors are extremely flammable and can ignite under certain conditions.

CAUTION



Avoid skin contact with engine oil or gasoline. Prolonged skin contact with engine oil or gasoline can be harmful. Frequent and prolonged contact with engine oil may cause skin cancer. Take protective measures and wear protective clothing and equipment. Wash all exposed skin with soap and water.

Maintenance Schedule

WARNING



Failure to perform periodic maintenance or not following maintenance procedures can cause the pressure washer to malfunction and could result in death or serious injury.

NOTICE

Periodic maintenance intervals vary depending on pressure washer operating conditions. Operating the pressure washer under severe conditions, such as sustained high-load, high-temperature, or unusually wet or dusty environments, will require more frequent periodic maintenance. The intervals listed in the maintenance schedule should be treated only as a general guideline.

Following the maintenance schedule is important to keep the pressure washer in good operating condition. The following is a summary of maintenance items by periodic maintenance intervals.

MAINTENANCE

Model WP2700

Table 1: Maintenance Schedule - Owner Performed

Maintenance Item	Before Every Use	After First 5 Hours	After 25 Hours of Use or Every Year	After 50 Hours of Use or Every Year	After 100 Hours of Use or Every Year
Engine Oil	Check Level	Change	–	Change	–
Cooling Features	Check	–	–	–	Clean
Air Filter	Check	–	Check	Replace ¹	–
Spark Plug	–	–	–	Check/Clean	Replace

¹ Service more frequently if operating in dry and dusty conditions.

Table 2: Maintenance Schedule - Authorized Westinghouse Service Dealer Performed

Maintenance Item	Before Every Use	After First 5 Hours	After 25 Hours of Use or Every Year	After 50 Hours of Use or Every Year	After 100 Hours of Use or Every Year
Fuel Filter	Check	–	–	Replace	–
Valve Clearance	–	–	–	–	Check/Adjust
Combustion Chamber	–	–	–	–	Decarbonize

Model WP3000

Table 3: Maintenance Schedule - Owner Performed

Maintenance Item	Before Every Use	After First 5 Hours	After 50 Hours of Use or Every Year	After 100 Hours of Use or Every Year	After 200 Hours of Use or Every Year
Engine Oil	Check Level	Change	–	Change	–
Cooling Features	Check	–	–	Clean	–
Air Filter	Check	–	Check/Clean	Replace ¹	–
Spark Plug	–	–	–	Replace	Replace

¹ Service more frequently if operating in dry and dusty conditions.

Table 4: Maintenance Schedule - Authorized Westinghouse Service Dealer Performed

Maintenance Item	Before Every Use	After First 5 Hours	After 50 Hours of Use or Every Year	After 100 Hours of Use or Every Year	After 200 Hours of Use or Every Year
Fuel Filter	Check	–	–	Replace	–
Valve Clearance	–	–	–	Check/Adjust	–
Combustion Chamber	–	–	–	Decarbonize	–
Fuel Line	–	–	–	–	Replace

ENGINE OIL MAINTENANCE

Engine Oil Specification

1. Only use the engine oil specified in *Figure 35*.

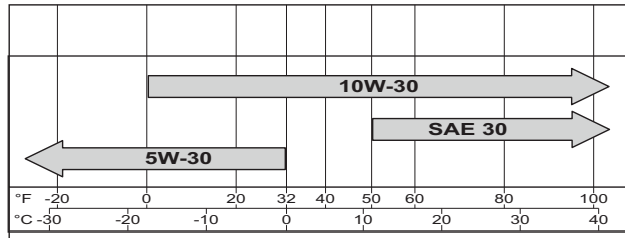

Figure 35 – Recommended Oil

2. Only use 4-stroke/cycle engine oil. NEVER USE 2-STROKE/CYCLE OIL.

Checking Engine Oil

NOTICE

Always maintain proper engine oil level. Failure to maintain proper engine oil level could result in severe damage to the engine and/or shorten the life of the engine.

Always use the specified engine oil. Failure to use the specified engine oil can cause accelerated wear and/or shorten the life of the engine.

Model WP2700

Engine oil level should be checked before every use.

1. Always operate or maintain the pressure washer on a flat surface.
2. Stop engine if running.
3. Let engine sit and cool for several minutes (allow crankcase pressure to equalize).
4. With a damp rag, clean around the oil fill plug/dipstick.

5. Remove oil fill plug/dipstick (*see Figure 36*).



Figure 36 – Oil Fill Plug/Dipstick – WP2700

6. Check oil level:

When checking the engine oil, remove the oil fill plug/dipstick and wipe it clean. Thread the oil fill plug/dipstick all the way back in and then remove and check the oil level on the oil fill plug/dipstick.

- Acceptable Oil Level – Oil is at the F line on the oil fill plug/dipstick (*see Figure 37*).
- Low Oil – Oil is below the F line on the oil fill plug/dipstick (*see Figure 37*).



Figure 37 – Checking Oil Level – WP2700

Model WP3000

Engine oil level should be checked before every use.

1. Always operate or maintain the pressure washer on a flat surface.
2. Stop engine if running.
3. Let engine sit and cool for several minutes (allow crankcase pressure to equalize).

4. With a damp rag, clean around one of the two oil fill plugs/dipsticks. Either one can be used.
5. Remove one of the oil fill plugs/dipsticks (see Figure 38).

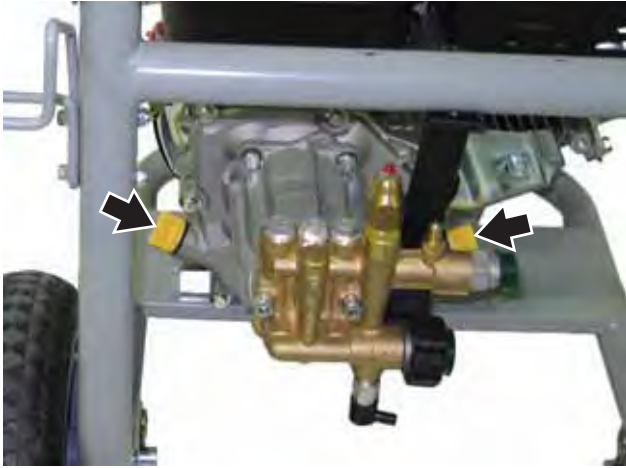

Figure 38 – Oil Fill Plug/Dipstick – WP3000

6. Check oil level:
When checking the engine oil, remove the oil fill plug/dipstick and wipe it clean. Thread the oil fill plug/dipstick all the way back in and then remove and check the oil level on the oil fill plug/dipstick.
 - Acceptable Oil Level – Oil is visible on the crosshatch lines on the oil fill plug/dipstick (see Figure 39).
 - Low Oil – Oil is not visible on the crosshatch lines on the oil fill plug/dipstick (see Figure 39).



Figure 39 – Checking Oil Level – WP3000

Adding Engine Oil

NOTICE

Oil crankcase capacity is 0.6 liter. Do not overfill.

1. Always operate or maintain the pressure washer on a flat surface.
2. Stop engine if running.
3. Let engine sit and cool for several minutes (allow crankcase pressure to equalize).
4. Thoroughly clean around the oil fill plug/dipstick.
5. Remove oil fill plug/dipstick and wipe clean.
6. See *Engine Oil Specification* on page 31 for the proper engine oil.
7. Slowly add engine oil to the engine. Stop frequently to check the level to avoid overfilling.
8. Continue to add oil until the oil is at the correct level. See *Checking Engine Oil* on page 31.

Changing Engine Oil

Model WP2700

1. Stop the engine. Ensure gas cap properly sealed.
2. Let engine sit and cool for several minutes (allow crankcase pressure to equalize and hot surfaces to cool down).
3. Place oil pan (or suitable container) beside the oil fill plug/dipstick.
4. Remove the oil fill plug/dipstick so the oil can drain (see Figure 40).



Figure 40 – Oil Fill/Drain Location – WP2700

- Using two people, tip the pressure washer toward the container until level with the ground.
 - Do not tip the pressure washer upside down. Maintain the position until oil has stopped dripping from the oil filter tube.
- Return the pressure washer to the upright position.
- With a clean rag, thoroughly clean around the oil filler cap. Allow oil to completely drain.
- Fill crankcase with oil following the steps outlined in *Adding Engine Oil on page 32*.
- Dispose of used engine oil properly.

Model WP3000

- Stop the engine.
- Let engine sit and cool for several minutes (allow crankcase pressure to equalize).
- Place oil pan (or suitable container) under one of the two oil drain plugs. The oil drain plugs are located on either side of the engine.
- With a damp rag, thoroughly clean around the oil drain plug.
- Place a flexible piece of plastic or cardboard below the oil drain plug and above the frame.
- Remove the oil drain plug (see *Figure 41*). Once removed, place the oil drain plug on a clean surface.



Figure 41 – Oil Drain Plug – WP3000

- Remove the oil fill plug/dipstick so the oil can drain more easily from the oil drain port.
- Allow oil to completely drain.
- Replace oil drain plug.
- Fill crankcase with oil following the steps outlined in *Adding Engine Oil on page 32*.
- Dispose of used engine oil properly.

NOTICE

Never dispose of used engine oil by dumping the oil into a sewer, on the ground, or into groundwater or waterways. Always be environmentally responsible. Follow the guidelines of the Environmental Protection Agency (EPA) or other governmental agencies for proper disposal of hazardous materials. Consult local authorities or reclamation facility.

AIR FILTER MAINTENANCE

WARNING



Never use gasoline or other flammable solvents to clean the air filter. Use only household detergent soap to clean the air filter.

Model WP2700

The air filter must be replaced after every 50 hours of use or every year (frequency should be increased if pressure washer is operated in a dusty environment).

NOTE: *The air filter cannot be cleaned with compressed air.*

- Turn off the pressure washer and let it cool for several minutes if running.
- Move the pressure washer to a flat, level surface.
- Loosen the knob and open the air cleaner cover (see *Figure 42*).



Figure 42 – Opening Air Cleaner Cover

- Clean the air cleaner cover with a clean rag.

MAINTENANCE

5. Remove the air filter element (see Figure 43).



Figure 43 – Air Filter Element

6. Insert the new air filter element in the air cleaner assembly box.
7. Close the air cleaner cover and secure the knob.

Model WP3000

The air filter foam element must be cleaned after every 50 hours of use or every year (frequency should be increased if pressure washer is operated in a dusty environment). The air filter paper element must be replaced after every 50 hours of use or every year (frequency should be increased if pressure washer is operated in a dusty environment).

1. Turn off the pressure washer and let it cool for several minutes if running.
2. Move the pressure washer to a flat, level surface.
3. Loosen the wing nut on top of the air cleaner cover (see Figure 44) and remove the cover.



Figure 44 – Opening Air Cleaner Cover

4. Clean the air cleaner cover with a clean rag.

5. Remove the air filter element (see Figure 45).



Figure 45 – Removing Air Filter Element

6. The air filter element consists of two components: the air filter foam element and the air filter paper element (see Figure 46).



Figure 46 – Air Filter Element Components

1 - Foam Element

2 - Paper Element

7. Wash the air filter foam element by submerging the element in a solution of household detergent soap and warm water. Slowly squeeze the foam to thoroughly clean.

NOTICE

NEVER twist or tear the foam air filter element during cleaning or drying. Only apply slow but firm squeezing action.

8. Rinse in clean water by submerging the air filter foam element in fresh water and applying a slow squeezing action.

NOTICE

Never dispose of soap cleaning solution used to clean the air filter by dumping the solution into a sewer, on the ground, or into groundwater or waterways. Always be environmentally responsible. Follow the guidelines of the EPA or other governmental agencies for proper disposal of hazardous materials. Consult local authorities or reclamation facility.

9. Dispose of used soap cleaning solution properly.
10. Dry the air filter foam element by again applying a slow firm squeezing action.
11. If necessary, replace the air filter paper element.
12. Return both air filter components to their position.
13. Return the air cleaner cover and secure it with the wing nut.

SPARK PLUG MAINTENANCE

The spark plug must be replaced after every 100 hours of use or every year.

1. Stop the pressure washer and let it cool for several minutes if running.
2. Move the pressure washer to a flat, level surface.
3. Remove the spark plug boot by firmly pulling the plastic spark plug boot handle directly away from the engine (see Figure 47 and Figure 48).



Figure 47 – Spark Plug Location – WP2700



Figure 48 – Spark Plug Location – WP3000

4. Clean area around the spark plug.

MAINTENANCE

5. Remove the spark plug from the cylinder head.
6. Place a clean rag over the opening created by the removal of the spark plug to make sure no dirt can get into the combustion chamber.
7. Inspect the spark plug for:
 - Cracked or chipped insulator
 - Excessive wear
 - Spark plug gap (the correct value is 0.030 in. [0.76 mm]) (see Figure 49).

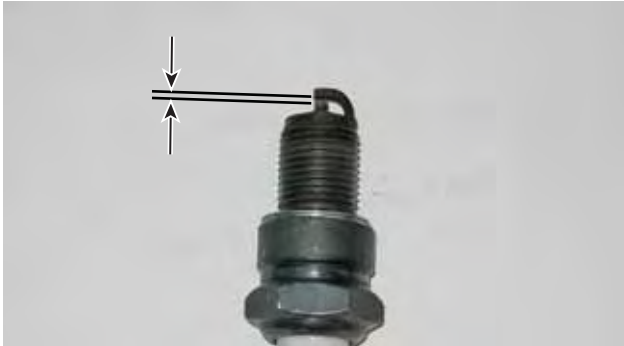

Figure 49 – Spark Plug Gap Requirements

If the spark plug fails any one of the conditions listed above, replace the plug with a Kohler® 1413203 plug or equivalent.

8. Install the spark plug by carefully following the steps outlined below:
 - a - Carefully insert the spark plug back into the cylinder head. Hand-thread the spark plug until it bottoms out.
 - b - Turn the spark plug to ensure it is fully seated. Torque plug to 20 ft-lb (27 N·m).
 - c - Replace the spark plug boot, making sure the boot fully engages the spark plug's tip.

PRESSURE WASHER COMPONENTS

Water Filter Screen

1. Remove the water inlet hose.
2. Remove the cone-shaped water filter screen from the water inlet hose fitting (see Figure 50).



Figure 50 – Water Filter Screen (Model WP2700 Shown)

3. Inspect the water filter screen for debris or damage.
4. If the water filter screen is clogged or full of debris, clean it by flushing it with water on both sides. If it is damaged, replace it.
5. Reinsert the water filter screen into the water inlet hose fitting. The cone side has to face out.

High-Pressure Hose and Spray Gun

High-Pressure Hose

1. Remove the high-pressure hose.
2. Inspect the O-rings on the hose fittings. Replace if cracked or split.
3. Inspect the high-pressure hose for leaks or damage.
4. Replace the high-pressure hose if it leaks or damage is present.

Spray Gun

1. Inspect the O-ring on the wand where it connects to the spray gun. Replace if cracked or split.
2. Inspect the connection between the hose and the spray gun. Ensure that the hose is connected tightly to the fitting on the spray gun.
3. Release the blue trigger lock by slightly pushing the trigger forward.
4. Test the trigger by pulling it backward. Make sure that the trigger returns to its original position when it is released.

Soap Siphon Hose

1. Remove the soap siphon hose (see Figure 51) from the soap container (if it is immersed).



Figure 51 – Soap Siphon Hose (Model WP2700 Shown)

2. Inspect the soap siphon hose. Clean it if it is clogged.
3. Inspect the soap siphon hose for leaks or damage.
4. Replace soap siphon hose if it is damaged.

Nozzle

1. Shut off the pressure washer and turn off the water supply.
2. Pull the trigger of the spray gun to release any remaining water pressure.
3. Remove the spray tip from the end of the nozzle extension (see Figure 52).

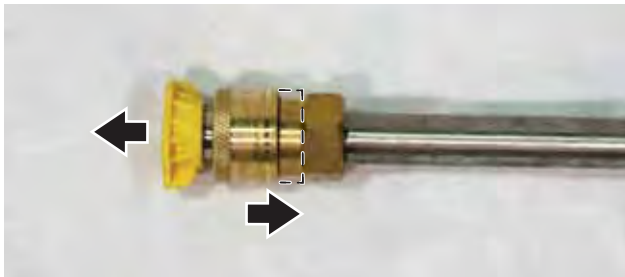

Figure 52 – Spray Tip Removal

4. Remove any obstructions with a small paper clip or similar tool.
5. Flush the spray tip with clean water.

6. Remove the nozzle extension from the spray gun (see Figure 53).



Figure 53 – Nozzle Extension Removal

7. Flush clean water through the nozzle extension for 30 – 60 seconds.
8. Reconnect the nozzle extension to the spray gun.
9. Reinstall the spray tip into the nozzle extension.

AFTER EACH USE

1. Shut off the pressure washer and turn off the water supply.
2. Remove the soap siphon hose from the soap container and insert it into a container with clean water.
3. Turn on the water supply and start the pressure washer.
4. Pull the spray gun trigger and spray for 1 – 2 minutes. This will ensure that all remaining soap is flushed from the pump.
5. Shut off the pressure washer and turn off the water supply.
6. Pull the spray gun trigger to release any remaining pressure.
7. Let the pressure washer cool down.
8. Disconnect the high-pressure hose and water inlet hose.
9. Drain the hoses, spray gun and nozzle extension.
10. Engage the trigger lock on the spray gun.
11. Wipe off remaining water with a clean, dry rag.
12. While the pressure washer is turned off, pull the recoil handle 5 – 6 times. This should remove most of the remaining liquid inside the pump.
13. Store the pressure washer in a clean, dry place.

MAINTENANCE

LONG-TERM STORAGE

WARNING



Never store a pressure washer with fuel in the tank indoors or in a poorly ventilated area where the fumes can come in contact with an ignition source such as a: 1) pilot light of a stove, water heater, clothes dryer or any other gas appliance; or 2) spark from an electric appliance.

NOTICE

Gasoline stored for as little as 60 days can go bad, causing gum, varnish and corrosive buildup in fuel lines, fuel passages and the engine. This corrosive buildup restricts the flow of fuel, preventing an engine from starting after a prolonged storage period.

Proper care should be taken to prepare the pressure washer for any long-term storage.

Storage Procedure for 1 – 3 Months

1. Clean the pressure washer as outlined in *After Each Use on page 37*.
2. Add a gasoline fuel stabilizer to the fuel tank. Follow the recommended procedure of the fuel stabilizer manufacturer for correct amount of stabilizer to add.

Storage Procedure for Greater Than 3 Months

1. Clean the pressure washer as outlined in *After Each Use on page 37*.
2. Drain all gasoline from the fuel tank as best as possible.
3. Connect a hose to the water inlet fitting and turn on the hose.
4. Start the engine and allow the pressure washer to run until all the remaining gasoline in the fuel lines and carburetor is consumed and the engine shuts off.
5. Clean the pressure washer as outlined in *After Each Use on page 37*.
6. Change the oil (see *Changing Engine Oil on page 32*).
7. Remove the spark plug (see *Spark Plug Maintenance on page 35*) and place about 1 tablespoon of oil in the spark plug opening. While placing a clean rag over the spark plug opening, slowly pull the recoil handle to allow the engine to turn over several times. This will distribute the oil and protect the cylinder wall from corroding during storage.

8. Replace the spark plug (see *Spark Plug Maintenance on page 35*).
9. Move the pressure washer to a clean, dry place for storage.

WINTER STORAGE

1. Follow steps 1 through 11 in *After Each Use on page 37*.
2. Store the hoses, spray gun and nozzle extension.
3. Disconnect the spark plug wire.
4. Connect a 3-foot (1-meter) section of garden hose to the water inlet hose fitting.
5. Using a funnel, pour 6 oz (177 mL) of RV antifreeze into the hose.

NOTICE

Use only RV antifreeze. Any other antifreeze can damage the pump.

6. Slowly pull the recoil handle several times, until antifreeze comes out of the high-pressure fitting of the pump.
7. Remove the 3-foot (1-meter) garden hose.
8. Reconnect the spark plug wire.
9. Store the pressure washer in a clean, dry place.

Remove and Install the Pump – WP2700

1. Disconnect high-pressure hose and soap siphon hose from pump.

NOTE: *The pump mounting bolts also mount the engine in place. Do not tip the unit or the engine could be damaged when pump is removed.*

2. Remove the 3 mounting bolts and washers holding the pump to the frame (see *Figure 54*).
3. Slide the pump down off of the crankshaft (see *Figure 54*).

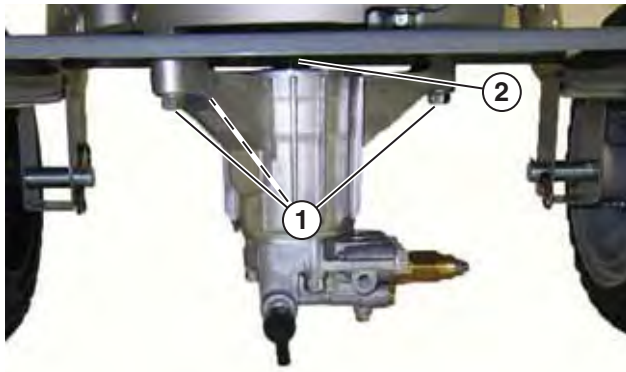

Figure 54 – Pump/Engine Mounting Bolts

1 - Pump/Engine Mounting Bolts 2 - Engine Crankshaft

4. Apply a thin layer of grease to the crankshaft before installing the pump.
5. Inspect the key and keyway on crankshaft (see Figure 55).



Figure 55 – Key and Crankshaft Keyway

6. Slide the pump onto the crankshaft making sure the key lines up with the keyway in the pump.
7. Install the pump/engine mounting bolts and tighten to 25 ft-lb (34 N·m).

Remove and Install the Pump – WP3000

1. Disconnect high-pressure hose and soap siphon hose from pump.
2. Remove the 4 mounting bolts and washers holding the pump to the engine (see Figure 56).
3. Slide the pump out off of the crankshaft (see Figure 56).



Figure 56 – Pump Mounting Bolts

4. Inspect the key and keyway on crankshaft (see Figure 57).
5. Apply a thin layer of grease to the crankshaft before installing the pump.



Figure 57 – Key and Crankshaft Keyway

6. Slide the pump onto the crankshaft making sure the key lines up with the keyway in the pump.
7. Install the pump/engine mounting bolts and tighten to 30 ft-lb (41 N·m).

TROUBLESHOOTING

TROUBLESHOOTING

WARNING



Before attempting to service or troubleshoot the pressure washer, the owner or service technician must first read the owner's manual and understand and follow all safety instructions. Failure to follow all instructions may result in conditions that can lead to voiding of the EPA certification or product warranty, serious personal injury, property damage or even death.

PROBLEM	POTENTIAL CAUSE	SOLUTION
Engine will not start.	1. Fuel shutoff valve (if equipped) is in the OFF position.	1. Move the fuel shutoff valve (if equipped) to the ON position.
	2. Pressure washer is out of fuel.	2. Add fuel to the pressure washer.
	3. Fuel flow is obstructed.	3. Inspect and clean fuel delivery passages.
	4. Unit is not properly primed.	4. Push primer bulb three times.
	5. Air filter is dirty.	5. Check and clean the air filter.
	6. Oil level is low.	6. Check oil level and add oil if necessary.
	7. Spark plug boot is not fully engaged with the spark plug tip.	7. Firmly push down on the spark plug to ensure the boot is fully engaged.
	8. Spark plug is faulty.	8. Remove and check the spark plug. Replace if faulty.
	9. Fuel is stale.	9. Drain fuel and replace with fresh fuel.
	10. Water in fuel.	10. Drain fuel and replace with fresh fuel.
	11. If trying 1-10 above does not solve the problem, the cause might be that the pressure washer has a fault.	11. Take the pressure washer to your nearest authorized service dealer.
Engine suddenly stops running.	1. Pressure washer is out of fuel.	1. Check fuel level. Add fuel if necessary.
	2. Oil level is low.	2. Check oil level and add oil if necessary.
	3. If trying 1-2 above does not solve the problem, the cause might be that the pressure washer has a fault.	3. Take the pressure washer to your nearest authorized service dealer.
Engine runs erratic; does not hold a steady RPM.	1. Choke lever (if equipped) was left in the ON position.	1. Move choke lever (if equipped) to the OFF position.
	2. Air filter is dirty.	2. Check and clean the air filter.
	3. If trying 1-2 above does not solve the problem, the cause might be that the pressure washer has a fault.	3. Take the pressure washer to your nearest authorized service dealer.

TROUBLESHOOTING

PROBLEM	POTENTIAL CAUSE	SOLUTION
No or low pressure.	1. Water supply is low.	1. Increase the water supply.
	2. Nozzle is obstructed.	2. Clean the nozzle.
	3. Water filter screen is obstructed.	3. Remove and clean the filter.
	4. Water inlet is obstructed.	4. Clear the inlet.
	5. Inlet hose is kinked or leaks.	5. Straighten the inlet hose and repair leaks.
	6. High-pressure hose is obstructed or leaks.	6. Clear obstructions in the hose or replace the hose.
	7. High-pressure hose fitting leaks.	7. Tighten the fitting. Apply sealant tape if necessary.
	8. If trying 1-7 above does not solve the problem, the cause might be that the pressure washer has a fault.	8. Take the pressure washer to your nearest authorized service dealer.
Soap does not mix with water spray.	1. Soap siphon hose is not submerged.	1. Insert the soap siphon hose properly into the soap container.
	2. Soap siphon hose is obstructed.	2. Clear obstructions in the soap siphon hose.

WARRANTY

WESTPRO POWER SYSTEMS “THREE YEAR” LIMITED WARRANTY

Effective May 2012

WESTPRO’S RESPONSIBILITY

Westpro Power Systems, LLC (“WESTPRO”) warrants to the original purchaser that its Westinghouse line of pressure washers will be free from defects in material and workmanship. Under normal use and maintenance from the date of purchase, WESTPRO agrees to repair or replace at WESTPRO’s discretion, any defective product free of charge at any authorized WESTPRO Authorized Service Dealer within the below listed applications, time periods, limitations, and exclusions. THIS LIMITED WARRANTY IS EXTENDED TO THE ORIGINAL PURCHASER ONLY AND IS NOT TRANSFERABLE TO SUBSEQUENT OWNERS EXCEPT FOR EMISSION RELATED PARTS. This warranty is separate from the Emission Control Warranty Statement supplied with your new product. Please consult the Emission Control Warranty Statement for details regarding emission related parts. For a list of WESTPRO Authorized Service Dealers refer to www.westpropower.com or call 1-855-944-3571.

OWNER’S RESPONSIBILITY

To ensure trouble free warranty coverage it is important that you register your WESTPRO Westinghouse pressure washer. You may register on-line at www.westpropower.com, by automated phone at 1-855-944-3571, or by filling out and returning to WESTPRO the warranty registration card supplied with your pressure washer. Registering your product confirms your warranty coverage and provides a direct link between you and WESTPRO if we find it necessary to contact you.

Your receipt for purchase including date, model and serial number must be maintained and presented to a WESTPRO Authorized Service Dealer for warranty service. Proof of purchase rests solely with you, the original purchaser.

You must demonstrate reasonable care and use, and follow preventive maintenance, storage, fuel and oil usage as prescribed in the operator’s manual for your WESTPRO Westinghouse unit. Should a product difficulty occur, you must, at your expense, deliver or ship your WESTPRO Westinghouse unit to a WESTPRO Authorized Service Dealer for warranty repairs (which must occur within the applicable warranty period), and arrange for pick-up or return of your unit after the repairs have been made. For the WESTPRO Authorized Service Dealer nearest to you, call WESTPRO’s automated phone at 1-855-944-3571 or you may locate a WESTPRO Authorized Service Dealer at www.westpropower.com. Should you require assistance or have questions concerning WESTPRO’s Warranty Statement, you can contact us through the web at www.westpropower.com or call 1-855-944-3571.

PRODUCT WARRANTY APPLICATIONS AND PRODUCT WARRANTY PERIODS

CONSUMER APPLICATION

For the purpose of this limited warranty “Consumer Application” means usage by the original purchaser for the purpose of personal residential household or recreational use.

Parts and labor will be covered at 100% for a period of one (1) year from the date of purchase.

Parts only will be covered at 100% for a period of three (3) years from the date of purchase.

If proof of purchase is not available to establish the purchase date nor is the equipment registered as suggested herein, the date of manufacturing as recorded by WESTPRO will start the product warranty period.

This pressure washer is equipped with an engine that is covered exclusively by a separate warranty from the engine manufacturer. Please refer to the engine documentation included with the pressure washer for warranty information related to the engine.

COMMERCIAL APPLICATION

For the purpose of this limited warranty “Commercial Application” means usage by the original purchaser for the purpose of income producing, business related use. Once a pressure washer has been used for income producing and business related purposes, it shall thereafter be considered a “Commercial Application” and the following warranty will apply.

Parts and labor will be covered at 100% for a period of one (1) year from the date of purchase.

If proof of purchase is not available to establish the purchase date nor is the equipment registered as suggested herein, the date of manufacturing as recorded by WESTPRO will start the product warranty period.



EXCLUSIONS

- WESTPRO portable pressure washers that utilize non-WESTPRO replacement parts.
- Costs of normal maintenance and adjustments.
- Failures caused by any contaminated fuels, oils, or lack of proper oil levels.
- Repairs or diagnostics performed by individuals other than WESTPRO authorized dealers not authorized in writing by WESTPRO.
- Failures due to normal wear and tear, accident, misuse, abuse, negligence or improper use. As with all mechanical devices, the WESTPRO engines need periodic part(s) service and replacement to perform as designed. This warranty will not cover repair when normal use has exhausted the life of a part(s) or engine.
- Failures caused by any external cause or act of God, including but not limited to, collision, theft, vandalism, riot, war, fire, freezing, lightning, earth-quake, windstorm, hail, water, flood, tornado, or hurricane.
- Damage related to rodent and/or insect infestation.
- Products that are modified or altered in a manner not authorized in writing by WESTPRO.
- Any incidental, consequential or indirect damages caused by defects in materials or workmanship, or any delay in repair or replacement of the defective part(s).
- Failure due to misapplication.
- Telephone, cellular phone, facsimile, internet access, or other communication expenses.
- Expenses related to “customer instruction” or troubleshooting where no manufacturing defect is found.
- Overnight freight or special shipping costs for replacement part(s).
- Overtime, holiday or emergency labor.
- Starting batteries, fuses, light bulbs and engine fluids.

DISCLAIMER OF IMPLIED WARRANTIES

This limited warranty is in lieu of all other expressed or implied warranties, including any warranty of FITNESS FOR A PARTICULAR PURPOSE OR USE and any implied warranty of MERCHANTABILITY otherwise applicable to WESTPRO's Westinghouse line of pressure washers. WESTPRO and its affiliated companies shall not be liable for any special, incidental or consequential damage, including lost profits. There are no warranties extended other than as provided herein. This limited warranty may be modified only by WESTPRO. Any implied warranties allowed by law shall be limited in duration to the terms of the express warranty provided herein. Some states do not allow limitations on how long an implied warranty lasts, so the above limitation may not apply to you. Some states do not allow the exclusion or limitation of incidental or consequential damages, so the above limitation may not apply to you. This warranty gives you specific legal rights. You also have other rights from state to state. WESTPRO'S ONLY LIABILITY SHALL BE THE REPAIR OR REPLACEMENT AS STATED ABOVE. IN NO EVENT SHALL WESTPRO BE LIABLE FOR ANY INCIDENTAL OR CONSEQUENTIAL DAMAGES, EVEN IF SUCH DAMAGES ARE A DIRECT RESULT OF WESTPRO'S NEGLIGENCE. Some states do not allow the exclusion or limitation of incidental or consequential damages, so the above limitation may not apply to you. This warranty gives you specific legal rights and you may also have other rights from state to state.

This limited warranty is given by Westpro Power Systems, LLC, W237 N2889 Woodgate Rd. Unit B, Pewaukee, WI 53072.

EMISSIONS CONTROL WARRANTY

FEDERAL AND/OR CALIFORNIA EMISSION CONTROL WARRANTY STATEMENT

YOUR WARRANTY RIGHTS AND OBLIGATIONS

Westpro Power Systems, LLC, the United States Environmental Protection Agency (EPA), and, for those products certified for sale in the state of California, the California Air Resources Board (CARB) are pleased to explain the emission (evaporative and/or exhaust) control system (ECS) warranty on your outdoor 2012 and later small off-road spark-ignited engine and equipment(outdoor equipment engine). In California, new outdoor equipment engines must be designed, built and equipped to meet the state's stringent anti-smog standards (in other states, 1997 and later model year equipment must be designed, built, and equipped to meet the U.S. EPA small off-road, spark ignition engine regulations). Westpro Power Systems, LLC must warrant the ECS on your outdoor equipment engine for the period of time listed below provided there has been no abuse, neglect or improper maintenance of your outdoor equipment engine.

Your ECS may include parts such as the carburetor, fuel-injection system, the ignition system, catalytic converter, fuel tanks, fuel lines, fuel caps, valves, canisters, filters, vapor hoses, clamps, connectors, and other associated emission-related components.

Where a warrantable condition exists, Westpro Power Systems, LLC will repair your outdoor equipment engine at no cost to you including diagnosis, parts and labor.

MANUFACTURER'S WARRANTY COVERAGE:

This emission control system is warranted for two years. If any emission-related part on your outdoor equipment engine is defective, the part will be repaired or replaced by a **Westpro Power Systems, LLC Authorized Warranty Service Dealer**.

OWNER'S WARRANTY RESPONSIBILITIES:

As the outdoor equipment engine owner, you are responsible for performance of the required maintenance listed in your owner's manual. Westpro Power Systems, LLC recommends that you retain all receipts covering maintenance on your outdoor equipment engine, but Westpro Power Systems, LLC cannot deny warranty solely for the lack of receipts or your failure to ensure the performance of all scheduled maintenance.

As the outdoor equipment engine owner, you should however be aware that Westpro Power Systems, LLC may deny you warranty coverage if your outdoor equipment engine or a part has failed due to abuse, neglect, or improper maintenance or unapproved modifications.

You are responsible for presenting your outdoor equipment engine to a Westpro Power Systems, LLC's Authorized Warranty Service Dealer as soon as the problem exists. The warranty repairs should be completed in a reasonable amount of time, not to exceed 30 days.

If you have any questions regarding your warranty rights and responsibilities, you should contact a Westpro Power Systems, LLC Service Representative at 1-855-WHHELP1 (1-855-944-3571) or contact Westpro Power Systems, LLC at the following address: W237 N2889 Woodgate Road, Unit B, Pewaukee, WI 53072.

DEFECTS WARRANTY REQUIREMENTS

Westpro Power Systems, LLC warrants to the original, end-use purchaser/owner and each subsequent purchaser that the outdoor equipment engine is:

1. Designed, built and equipped so as to conform with all applicable regulations
2. Free from defects in materials and workmanship that can cause the failure of a warranted part at any time during the ECS Warranty period.
3. Warranted parts are identical in all material respects to that part as described in Chongqing Zongshen General Power Machine Co., LTD's application for certification.

The warranty period begins on the date the outdoor equipment engine is delivered to the original, end-use purchaser/owner or first placed into service. The warranty period is two years.



EMISSIONS CONTROL WARRANTY

Subject to certain conditions and exclusions as stated below, the warranty on emission-related parts is as follows:

1. Any warranted part that is not scheduled for replacement as required maintenance in the written instructions supplied, is warranted for the warranty period stated above. If the part fails during the period of warranty coverage, the part will be repaired or replaced by Westpro Power Systems, LLC according to subsection (4) below. Any such part repaired or replaced under warranty will be warranted for the remainder of the period.
2. Any warranted part that is scheduled only for regular inspection in the written instructions supplied is warranted for the warranty period stated above. Any such part repaired or replaced under warranty will be warranted for the remaining warranty period.
3. Any warranted part that is scheduled for replacement as required maintenance in the written instructions supplied is warranted for the period of time before the first scheduled replacement date for that part. If the part fails before the first scheduled replacement, the part will be repaired or replaced by Westpro Power Systems, LLC according to subsection (4) below. Any such part repaired or replaced under warranty will be warranted for the remainder of the period prior to the first scheduled replacement point for the part.
4. Repair or replacement of any warranted part under the warranty provisions herein must be performed by a Westpro Power Systems, LLC Authorized Warranty Service Dealer at no charge to the owner.
5. The owner must not be charged for diagnostic labor that leads to the determination that a warranted part is in fact defective, provided that such diagnostic work is performed at a Westpro Power Systems, LLC Authorized Warranty Service Dealer.
6. Westpro Power Systems, LLC is liable for damages to other engine or equipment components proximately caused by a failure under warranty of any warranted part. Throughout the off-road engine and equipment warranty period stated above, Westpro Power Systems, LLC will maintain a supply of warranted parts sufficient to meet the expected demand for such parts.
7. Any authorized Westpro Power Systems, LLC replacement part may be used in the performance of any warranty maintenance or repairs and must be provided without charge to the owner. Such use will not reduce the warranty obligations of Westpro Power Systems, LLC.
8. Add-on or modified parts that are not exempted by the EPA or CARB may not be used. The use of any non-exempted add-on or modified parts by the original, end use purchaser/owner and each subsequent purchaser/owner will be grounds for disallowing warranty claims. Westpro Power Systems, LLC will not be liable to warrant failures of warranted parts caused by the use of a non-exempted add-on or modified part.
9. The manufacturer issuing the warranty shall provide any documents that describe that manufacturer's warranty procedures or policies within five working days of request by the CARB.

WARRANTED PARTS:

The repair or replacement of any warranted part otherwise eligible for warranty coverage may be excluded from such warranty coverage if Westpro Power Systems, LLC demonstrates that the outdoor equipment engine has been abused, neglected, or improperly maintained, and that such abuse, neglect, or improper maintenance was the direct cause of the need for repair or replacement of the part. That notwithstanding, any adjustment of a component that has a factory installed, and properly operating, adjustment limiting device is still eligible for warranty coverage. Further, the coverage under this warranty extends only to parts that were present on the off-road engine and equipment purchased.

The following emission warranty parts are covered (if applicable):

1. Fuel Metering System
 - Cold start enrichment system (soft choke)
 - Carburetor and internal parts (or fuel injection system)
 - Fuel pump
 - Fuel tank
2. Air Induction System
 - Air cleaner
 - Intake manifold

EMISSIONS CONTROL WARRANTY

3. Ignition System
 - Spark plug(s)
 - Magneto ignition system
4. Exhaust System
 - Catalytic converter
 - SAI (Reed valve)
5. Miscellaneous Items Used in Above System
 - Vacuum, temperature, position, time sensitive valves and switches
 - Connectors and assemblies
6. Evaporative Control
 - Fuel hose
 - Fuel hose clamps
 - Tethered fuel cap
 - Carbon canister
 - Vapor lines

QUESTIONS:

If you have any questions regarding your emissions warranty rights and responsibilities you should contact Westpro Power Systems, LLC at:

Phone: (855) 944-3571, toll free

Web: service@westpropower.com

Address: Service Department
Westpro Power Systems, LLC
W237 N2889 Woodgate Road, Unit B
Pewaukee, WI 53072

**California
Proposition 65 Warning**

The engine exhaust from this product contains chemicals known to the state of California to cause cancer, birth defects or other reproductive harm.

**California
Proposition 65 Warning**

Certain components in this product and its related accessories contain chemicals known to the state of California to cause cancer, birth defects or other reproductive harm. Wash hands after handling.

EXCLUSIONES:

Toda la información, las ilustraciones y especificaciones de este manual se basan en la información más reciente disponible al momento de la publicación. Las ilustraciones que se utilizan en este manual están destinadas a representar vistas de referencia únicamente. Además, debido a nuestra política de mejora continua del producto podemos modificar la información, las ilustraciones y/o las especificaciones para explicar y/o ejemplificar una mejora de producto, servicio o mantenimiento. Nos reservamos el derecho a realizar cualquier cambio en cualquier momento sin aviso.

TODOS LOS DERECHOS RESERVADOS:

Ninguna parte de esta publicación se puede reproducir ni usar por ningún medio, sea gráfico, electrónico o mecánico, incluido el uso de fotocopias, grabaciones, grabaciones en cinta o de sistemas de almacenamiento y recuperación de información, sin el permiso por escrito de Westpro Power Systems, LLC.