

**WATTS**  
**SunTouch**  
**UnderFloor™**  
Electric Radiant Floor Warming

# Installation Manual

## CONTENTS

**Introducing SunTouch UnderFloor  
Materials and Cautions**

**PART 1**  
**Inspect the Mat and Sensor**

**PART 2**  
**Electrical Service Rough-in**

**PART 3**  
**Install the Mat**

**PART 4**  
**Final Wiring**

**PART 5**  
**Install the Insulation**

**PART 6**  
**Wiring Diagrams**

**PART 7**  
**Troubleshooting Guide**

Please be aware that local codes may require this product and/or the control to be installed or connected by an electrician.



[www.suntouch.com](http://www.suntouch.com)

888-432-8932



# Introducing SunTouch® UnderFloor™

SunTouch UnderFloor is a safe and efficient electric floor-warming product for interior applications. It is intended only for installation under a wood subfloor in residential and light commercial installations. It is not designed for other purposes such as roof snow-melting. Any use or installation of this product other than what is stated in this installation manual will void the Limited Warranty.

SunTouch UnderFloor is designed to deliver approximately 10 watts/sq. ft. of floor area. The temperature of the warm floor is dependent on how well the floor is insulated, as well as the insulating value of the flooring materials. If the joist space is sealed against air leakage, exterior rim joists are insulated, and the underneath side of the floor is insulated, most floors can be heated up to 15°F warmer than they would otherwise be. Due to the insulating value of carpet, carpeted floors may not achieve the same temperature rise. The floor may or may not achieve this temperature rise, and no representations are made regarding the performance of any system.

For best results, install unfaced fiberglass R-19 or R-13 (or equivalent) below the mat. Do not insulate below the mat with more than R-19, and no more than R-11 total on top of the subfloor, including all floor coverings, rugs and other items placed on top. SunTouch UnderFloor can be used to heat a room, as well as warm the floor, provided the heat loss of the room falls within the mat's capabilities. A designer must determine if the output from the SunTouch UnderFloor is

enough to match the heat loss of the structure. Refer to page 3 for helpful design guidelines.

## The SunTouch UnderFloor Mat

The mat is composed of a heating cable, a foil "radiator" to make a radiant surface, and a set of power leads for connection to the floor-sensing control. These mats are manufactured in sizes suitable to heat joist bays spaced 12", 16", and 19.2" on center. Mats are rated either 120 VAC or 240

VAC. Select the mat length to fit into the joist space available. Multiple mats can be used to fill a larger area, however they must be wired together in parallel (not in series) if they are to be connected to the same control. **NEVER combine 120-VAC mats with 240-VAC mats.**

Visit the SunTouch Web site at [www.suntouch.com](http://www.suntouch.com), or call 888-432-8932 if there are any questions regarding the installation of the mat or its related electrical components.

SunTouch UnderFloor™ mats are only intended for installation below the subfloor.

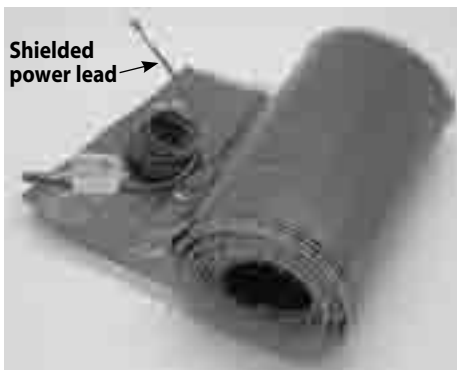

Shielded power leads make for a tougher and safer connection to the controls.

## Cross section of typical UnderFloor installation

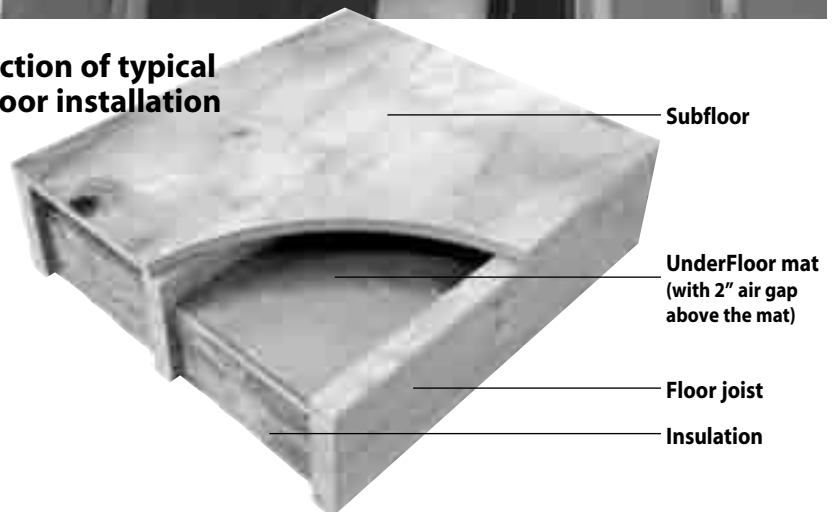

# Designing a SunTouch UnderFloor System

In general, SunTouch UnderFloor should be installed in all floor areas where floor warming is desired. It can be installed to either warm the floor or to heat the space. If SunTouch is being installed to heat the space, first perform a heat loss calculation. Use RadiantWorks® or a similar program to calculate the heat loss of the room(s). SunTouch can be expected to provide approximately 34 BTU/hr/sq.ft. of mat. This assumes the mats are installed per this manual, including the use of proper insulation techniques. Make sure insulation is installed as shown on page 10. There must be a “dead air space” for UnderFloor mats to be effective. This output also assumes a floor covering other than carpet and pad. The output will be greatly diminished with a carpet floor covering and/or the lack of proper insulation.

## Determine how much Mat is Needed for the Installaton

To determine how much mat is needed, take one of two approaches:

1. For a rough estimate, multiply the wall-to-wall area by 75%–80%. Convert this to linear feet of mat and select from the lengths of mat shown in the table on page 6.
2. For an accurate measurement, look under the subfloor to see where mats can be stapled. Looking carefully at each joist bay, measure the length of open area in that bay that can receive a mat, and select the mat from the table on page 6 that fits the space. Remember that these mats cannot be

cut shorter to fit, nor modified in any way to fit multiple joist bays. Do not include in these measurements areas that contain items that would obstruct installation of the mat (return air ducts, supply ducts, light fixtures, etc.). Where mats are not installed, the floor above will not get very warm.

## Wiring Multiple Mats Together

Each mat is designed to be installed in only one joist bay. The mats cannot be cut shorter to fit a shorter joist bay or modified in any way to fill multiple joist bays. However, more than one mat may be installed in a joist bay where there are barriers such as cross bracing. A typical installation is shown below.

Since several mats will be required to warm the floor area, the mats must be wired together in parallel (not in series) at a junction box below the floor, then electrical wire fed from there up to the floor-sensing control box. Select mats for the easiest wiring possible. If all the power leads end up at one end of the room, it will be much easier to wire them together in the junction box. The junction box must be accessible after all finishing work is completed. Be sure to position the mats so that this is possible.

## Mat Voltage Requirements

Select either 120-VAC mats or 240-VAC mats (see table on page 6). Do not mix 120-VAC mats and controls with 240-VAC mats and controls. Observe these general voltage guidelines:

1. For areas totaling up to about 190 sq. ft. (about 15 amps), use 120-VAC mats with a SunStat™ control.
2. For areas exceeding about 190 sq. ft. and up to about 350 sq. ft., use 240-VAC mats with a SunStat control to have mats totaling 15 amps or less.
3. Use 240-VAC mats and a SunStat/SunStat Relay control system (see wiring diagrams in Part 6) for mats totaling more than 15 amps at 240 VAC.

Regardless of the voltage requirements in a particular installation, make sure the circuit breaker can handle the load. Follow all electrical codes for determining the size of the breaker.

## Floor-sensing Controls

To control the SunTouch UnderFloor system, install either a programmable or non-programmable, floor-sensing SunTouch SunStat or SunStat Relay system. The sensor should be installed per instructions in Part 2 (page 7).

Please reference the SunTouch catalog, or contact a SunTouch distributor for more information.

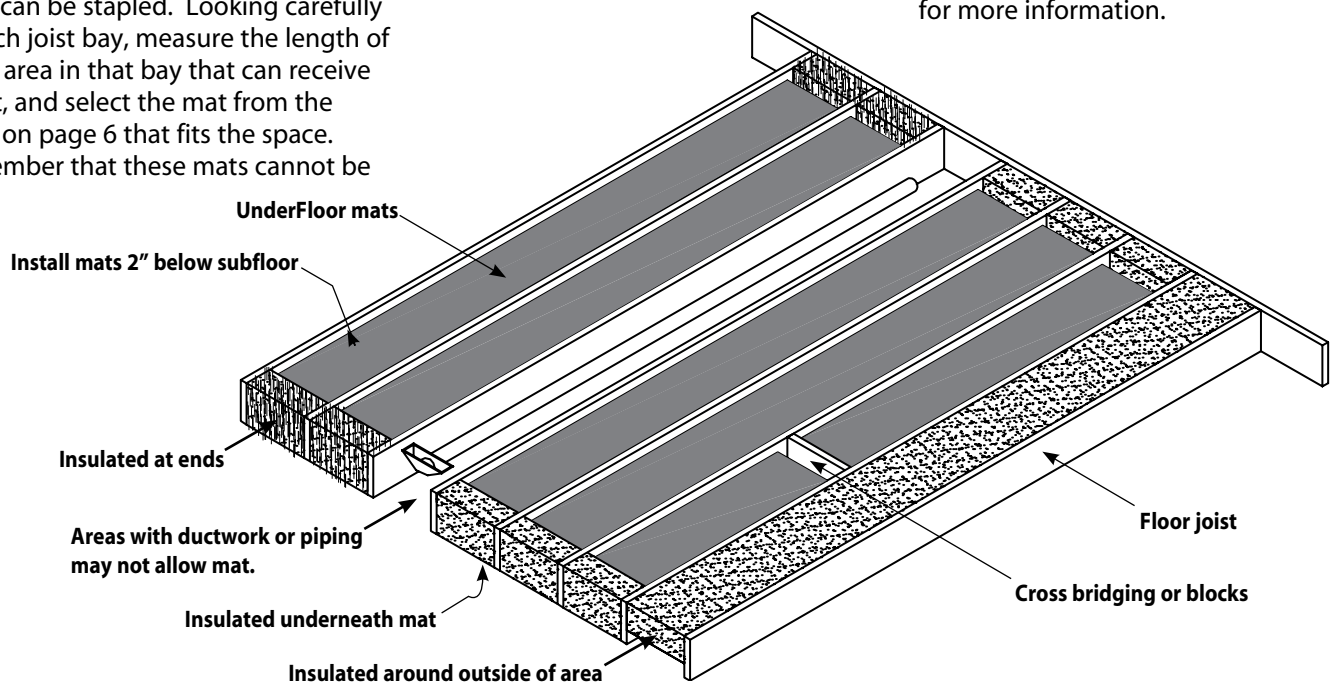

## Materials and Tools Needed

- SunTouch UnderFloor mat(s). \* See page 3 to determine how much mat is needed for each joist space.
- Floor-sensing SunStat control \* (programmable or nonprogrammable, with built-in GFCI), or a SunStat/SunStat Relay control system. †
- GFCI circuit breaker. (SunStat and SunStat Relay controls have a built-in GFCI; therefore, the GFCI-type circuit breaker is not recommended since two GFCIs may conflict and cause problems. If using the SunStat or SunStat Relay controls, use a standard circuit breaker.) †
- Floor sensor (included with control).
- SunTouch UnderFloor Installation Kit\* (includes an Installation Manual and NailTites™).
- Electrical junction box for power leads.
- An extra-deep electrical box for the floor-sensing control.
- 12-gauge electrical wiring.
- 3/4" conduit to protect power leads, if required by local code.
- LoudMouth™ monitor.
- Digital ohmmeter (multi-meter) able to measure up to 20,000 ohms (Ω).
- Various electrical/construction tools (staple gun, tape measure, marker, wire stripper, screwdriver, drill with 1/4" and 1/2" drill bits, and electrical fish-tape).
- Insulation (R-13 or R-19 fiberglass recommended).

\* Items available from SunTouch. All other items are not included and can be purchased locally.

† The SunStat and SunStat Relay are approved for use in the U.S. and Canada, separate from the SunTouch Listed assembly.

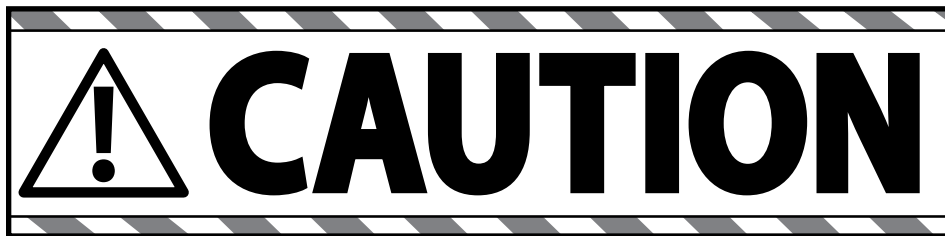

Read these cautions carefully before beginning the installation.

- NEVER** cut the mat, or remove the foil radiator, or modify the mat in any way. The mat must remain intact. However, the power leads may be cut shorter, if necessary, but never removed completely.
- NEVER** leave the mat rolled up or bunched in the joist bay. Make sure the mat is completely unrolled and is installed completely flat.
- NEVER** attempt to repair the mat if it is damaged. Call the factory for instructions.
- NEVER** install one mat on top of another or overlap the mat onto itself. Doing so will cause dangerous overheating.
- NEVER** forget to install the floor sensor.
- NEVER** remove the nameplate label.
- NEVER** allow metal objects such as staples, metal pipes, ductwork, or straps to remain in contact with the foil radiator of the mat.
- NEVER** staple closer than 1/4" from the heating wire.
- NEVER** install the mat closer than 2" from the subfloor.
- NEVER** install the mat closer than 8" from the edges of outlet boxes and junction boxes used to mount surface lighting fixtures.
- NEVER** run mats across joists.
- NEVER** insulate below the mat with greater than R-19, and no greater than R-11 total on top of the subfloor, including all floor coverings, rugs, and other items placed on top.

**ALWAYS** enter mat and sensor resistance readings in the Mat and Sensor Resistance Log (see page 5) before, during, and after the installation process.

**ALWAYS** pay close attention to the voltage and amperage requirements of the breaker, the control, and the mat. For instance, do not supply 240 VAC to 120-VAC mats or controls.

**ALWAYS** make sure all electrical work is done by qualified persons in accordance with local building and electrical codes, Section 62 of CEC Part I, and the National Electrical Code (NEC), especially Article 424, Part IX of the NEC, ANSI/NFPA 70.

**ALWAYS** use copper only as supply conductors.

**ALWAYS** affix the warning label (included with this manual) to the control or other location where it is easily noticed in the area containing the mat.

**ALWAYS** seek help if a problem arises. If ever in doubt about the correct installation procedure to follow, or if the product appears to be damaged, the factory must be contacted before proceeding with the installation.

Please visit [www.suntouchsupport.com](http://www.suntouchsupport.com), or call the Design Department at 888-432-8932 if there are any questions or problems regarding the installation of the mat or its related electrical components. If the product appears to be damaged, the factory must be contacted before proceeding with the installation or proposed repair.





# PART 1: Inspect the Mat and Sensor

## Monitor the Wire!

Throughout the installation process it is very important to take resistance readings of the mat and floor sensor wires to make sure they have not been damaged. Use a quality **digital** ohmmeter (multi-meter) able to measure up to 20,000 ohms ( $\Omega$ ) to take these readings. Analog meters (with the moving needle) are not accurate enough for this product.

## Use the LoudMouth™ Monitor

The LoudMouth is designed to monitor the mat during the installation process. If the heating wire is cut or damaged during installation, this device sounds an alarm. Ask about purchasing this valuable tool.



To retain the Limited Warranty, resistance readings and other data **MUST** be recorded in the Mat and Sensor Resistance Log below. Use the LoudMouth (right) to monitor the mat during the entire installation process.

## Essential Product Information and Warranty

Do not remove the nameplate label from the power leads (see photo). Record the serial number, mat size, voltage, and mat resistance range into the resistance log below for each mat and sensor wire.

To retain the Limited Warranty these items and the following resistance measurements **MUST** be recorded, as well as all steps of this manual followed. Refer now to the Limited Warranty on the back cover of this manual for complete requirements.

## Measurements

At the very least, take resistance readings (1) before beginning installation, (2) after the mat and sensor have been installed in the joist bay, and (3) after insulation is installed.

## Checking for Breaks

Measure resistance between the black and white leads (black and blue leads for 240-VAC mats) and record this below. This measurement should be within the range shown on the nameplate label. A cut or break in the wire is indicated by a resistance of “infinite” ohms (no continuity, or “OL” for “open line”).

## Checking for Short-Circuits

Measure resistances between the black and green leads and between the white and green leads (blue and green leads for 240-VAC mats) and record these below. These measurements should be “infinite” ohms (no continuity or “OL” for “open line”). A cut or pinch in the wire is indicated by a resistance value greater than zero but less than the mat resistance.

If the resistance is not correct, or if the wire has been cut or damaged, note the damaged area and call the factory for further instructions.

## Checking the Floor Sensor

The SunStat controls come with a floor sensor. This must be tested prior to installation. Use a quality **digital** ohmmeter that is capable of measuring at least 20,000 ohms ( $\Omega$ ), and measure between the lead wires of the sensor. The measurement varies according to the temperature sensed in the tip. The sensor resistance table on page 6 gives a set of approximate values for comparison.

If no resistance is detected, or if the resistance value is very different from that shown in the sensor resistance table, check the ohmmeter first to make sure it was correctly set. Then contact the factory for assistance.



Record the information from this nameplate label into the Mat and Sensor Resistance Log provided at right. Leave this nameplate label attached to the power leads for later inspection.

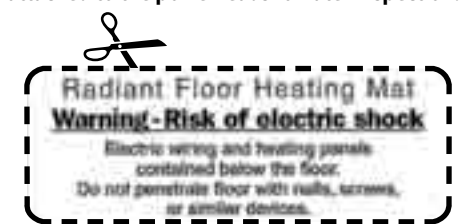

This Electric Radiant Heating Warning Label must be cut out and taped near, or on the face of the control.

## MAT AND SENSOR RESISTANCE LOG

	MAT 1	MAT 2	MAT 3
Mat Serial Number			
Mat Size			
Mat Voltage			
Factory Mat Resistance Range			
<b>OUT OF THE BOX BEFORE INSTALLATION (ohms)</b>			
Mat black to white			
Mat black to green			
Mat white to green			
Sensor Wire			
<b>AFTER SENSOR AND MAT ARE INSTALLED IN JOIST BAY (ohms)</b>			
Mat black to white			
Mat black to green			
Mat white to green			
Sensor Wire			
<b>AFTER INSULATION IS INSTALLED (ohms)</b>			
Mat black to white			
Mat black to green			
Mat white to green			
Sensor Wire			

Note: Wire colors listed are for 120-VAC mats. See directions above for the 240-VAC color combinations to check.

**RETAIN THIS LOG TO RETAIN THE WARRANTY! DO NOT DISCARD!**

# PART 2: Electrical Service Rough-in

## Circuit Overcurrent Protection and GFCI Protection

The SunTouch mat must be protected by a ground fault circuit interrupter (GFCI). If the mats are directly powered through the SunStat controls, these already have an integral GFCI to protect the mats (do not install a GFCI

type circuit breaker to supply a SunStat Control because the respective GFCIs may conflict and cause problems). If a different type control or relay is used that does not have a built-in Class A GFCI, an indicating-type GFCI circuit breaker must be used to protect the mats. This GFCI breaker serves as a local disconnect.

**NOTE: Follow all local building and electrical codes.**

It is recommended that the system be installed on its own dedicated circuit, directly from the circuit breaker panel. However, small systems may be able to tap into an existing circuit. Consult an electrician. Make sure there is adequate capacity for the mat(s) as well as any other items that may use this circuit. The mat(s) should not be installed in a circuit with another GFCI (breaker or outlet), lighting circuit (low-voltage, halogen, or other types that use ballasts or transformers that can interfere), or motor circuit (exhaust fan, hot tub, etc.) due to possible interference which can cause the GFCI on the control to false-trip.

The circuit breaker protecting the mat(s) must be no larger than 20 amps. Load the circuit breaker with no more than the following: 12 amps on a 15-amp circuit breaker, 16 amps on a 20-amp circuit breaker. Additional circuit breakers will be required for larger loads than these.

Select mats so that no more than 15 amps are run through a SunStat or SunStat Relay control.

## Large Systems on one Floor-sensing Control

For systems that are too large to directly power through one SunStat, but must be operated by one floor-sensing control, use the SunStat /SunStat Relay for best performance. Contact a SunTouch dealer or the factory for more information.

### Floor Sensor Resistance Values

Temperature	Typical Values
55°F (13°C)	17,000 ohms
65°F (18°C)	13,000 ohms
75°F (24°C)	10,000 ohms
85°F (29°C)	8,000 ohms

## Install Electrical Boxes

**SunStat box.** Decide on the location for the floor-sensing control. Usually this will be in the same room as the floor being warmed, but it can be mounted almost anywhere as long as it is not in a confined space where airflow is restricted. To reach this box with the mats, the mat power leads and the sensor wire leads can both be extended if needed with the appropriate size wire at a junction box.

The control electrical box may be a single-gang plastic deep box, but be sure to follow all electrical code requirements for box fill, grounding, etc. when determining the correct box for a particular application.

The control box should be located on interior walls, typically 60" from the floor, according to code requirements.

**NOTE: The SunStat sensor wire can be up to 50 ft. long, extended with 22- or 24-AWG wire.**

**SunStat Relay boxes.** The SunStat also may be used as a master to control SunStat Relays. The SunStat Relays may be located most anywhere as long as they are not in a confined space where airflow is restricted. To reach these controls with the mats, the mat power leads should first go to a junction box (see page 9) and then to a relay. (see instructions provided with the SunStat Relay controls). There is no floor sensor for these relays.

**Other junction boxes:** It is highly recommended that a separate steel electrical junction box be mounted below the subfloor or in the wall in a location to which the mat power leads can be routed. A separate wiring drop can be made from the control box down to this junction box. This makes it much easier to install the system.

## Bottom Plate Work

Drill a hole up through the wall bottom plate to route the power wiring from the control box to the mats below the floor.

## Rough-in Wiring

Install electrical wiring from the power source breaker to the control electrical box, and then to the junction

### UnderFloor Mat Sizes, Amperage Draw, and Resistance Ranges.

Mat Size	Amperage Draw	Resistance Range (ohms)
<b>120 VAC</b>		
12" x 5.5 ft.	0.4	247–302
12" x 8 ft.	0.6	167–204
12" x 10.5 ft.	0.9	121–148
12" x 13 ft.	1.1	97–119
12" x 16 ft.	1.3	80–98
12" x 19 ft.	1.5	67–82
16" x 4 ft.	0.4	258–315
16" x 6 ft.	0.6	173–211
16" x 8 ft.	0.8	126–154
16" x 9.5 ft.	1.0	101–123
16" x 12 ft.	1.3	82–101
16" x 14 ft.	1.5	69–85
16" x 16 ft.	1.7	63–78
16" x 18 ft.	1.9	53–65
16" x 19.5 ft.	2.1	45–56
19.2" x 4.5 ft.	0.7	170–207
19.2" x 6.5 ft.	0.9	127–155
19.2" x 8 ft.	1.0	103–126
19.2" x 9.5 ft.	1.3	83–102
19.2" x 11.5 ft.	1.5	71–87
19.2" x 13 ft.	1.7	63–78
19.2" x 14.5 ft.	1.8	54–66
19.2" x 16 ft.	2.1	45–56
<b>240 VAC</b>		
12" x 10.5 ft.	0.4	500–611
12" x 16 ft.	0.6	336–411
12" x 21 ft.	0.9	243–297
12" x 26 ft.	1.1	195–238
16" x 8 ft.	0.4	521–636
16" x 12 ft.	0.6	362–443
16" x 16 ft.	0.8	253–310
16" x 19.5 ft.	1.0	207–253
16" x 24 ft.	1.3	168–206
19.2" x 6.5 ft.	0.4	526–643
19.2" x 9.5 ft.	0.6	359–439
19.2" x 13 ft.	0.9	256–313
19.2" x 16 ft.	1.0	207–253
19.2" x 19 ft.	1.3	167–204
19.2" x 23 ft.	1.5	143–174
19.2" x 26 ft.	1.7	127–156

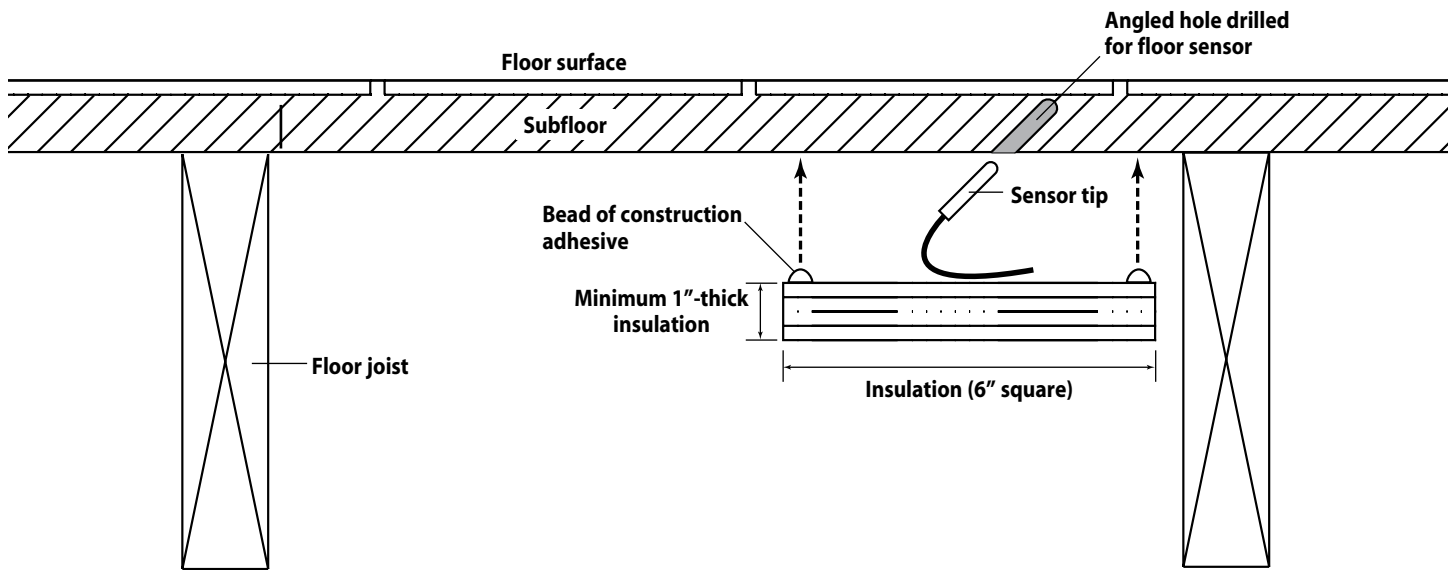

Diagram showing Method 1 for installing the floor sensor into the subfloor.

box below the floor for the mat leads. Leave 6"–8" of extra wire at the control box and junction box. Refer to the wiring diagrams in Part 6 for assistance.

### Install SunStat Sensor

A floor sensor comes with the SunStat control and must be installed correctly to control the floor temperature. Remember to locate the sensor in a floor where a mat is located. The following are recommended methods for installing the sensor. Other equivalent methods may be used.

**Before installing the sensor, make sure to test it with an ohmmeter. See page 5, "Checking the Floor Sensor."**

**Method 1.** Since a sensor may be difficult to install in some existing floors, the sensor may be placed under the subfloor. However, keep in mind that the temperature the sensor gives will not be a true floor surface temperature and the floor-sensing control may need to be adjusted accordingly.

Drill a hole through the bottom plate of the wall to route the sensor wire. Feed the sensor wire down from the control box through the floor. (A fish-tape may need to be used in order to do this.)

The most accurate method is to drill a 3/4"–1"-long hole at an angle into the bottom of the subfloor (drilling at an angle prevents puncturing through floor surface). Locate this hole in a

joist bay directly over where a mat will be installed, about 2" from the joist. Insert the sensor into the angled hole and seal it with adhesive. Insulate the sensor with additional "blueboard" or fiberglass insulation, 1"–2" thick and 6" square, adhered and sealed under the sensor. This will isolate the sensor from the heated joist space and give a truer floor surface temperature.

**Method 2.** If it is not possible to drill a hole to set the sensor in the subfloor, it may be held flat to the subfloor with a nylon wire clip. Locate the sensor in a joist bay directly over where a mat will be installed, about 2" from the joist. Insulate the sensor with additional "blueboard" or fiberglass insulation, 1"–2" thick and 6" square. This will help isolate the sensor from the heated joist space.

**Method 3.** If possible, install the sensor directly into or under the floor covering area.

If the floor surface is tiled, a grout line can be removed and the sensor laid into this grout line.

Drill a hole into the wall behind the baseboard trim area and directly below the control electrical box.

Feed the sensor through the knock-out, down to the hole that was drilled near the floor, and out into the floor above where the heating mat will be installed. Locate the sensor at least 1 ft. from outside walls and near the center of a joist space.

Complete the rest of the installation before covering or regrouting over the sensor.



**Method 3: Remove the grout 1/4" to 1/2" deep. Install sensor. Reinstall grout over the sensor and sensor wire.**

# PART 3: Install the Mat

See Part 6 for typical wiring diagrams.

Observe the following rules, plus all other electrical/building codes and the Cautions on Page 4 when installing the mat(s):

**Do not allow the foil radiator of the mat to be mounted such that it contacts metal objects such as nails, staples, metal pipes, heating ducts, and joist straps.**

**Keep the mat at least 2" away from recessed fixtures (lights, etc.), ventilation openings, and other openings.**

**Keep the mat at least 8" away from the edges of outlet boxes and junction boxes used to mount surface lighting fixtures.**

**Keep the mat at least 6" away from heat-sensitive items such as toilet rings, flexible ducting, and other items rated less than 194°F (90°C). Consult manufacturers of those items.**

**REMEMBER:**

**Pay careful attention to areas where ductwork, wiring, or other items do not allow the mat to be installed. Keep in mind that where mats are not installed, the corresponding floor area above will not get very warm.**

Before installing the mat, inspect all joists as well as the underside of the subfloor for nails, screws, or other sharp objects that protrude into the



Test fit the mat between the joists before stapling the mat to the joists.

joist cavity. These items can damage the mat, and must be removed, cut off, or bent flat against the underside of the subfloor or the side of the joist(s).

Do not staple, cut, or damage the foiled heating portion of the mat in any way. The fiber mesh of the mat is the portion that will be used to staple the mat to the joists.

**Do not leave the mat rolled up or bunched up in any way in the joist bay. Doing so will cause dangerous overheating and possible damage. Mats must be installed so that they are completely flat across the joist cavity.**



1. Measure between the floor joists where mat(s) will be installed. Measure the width of the mat selected to fit between these joists. The difference between these measurements determine how much mat mesh remains for stapling to each side of the joists. Because the distance between floor joists can vary, taking these measurements will help ensure the mat will be centered between the joists. It is also prudent to test fit the mat by holding the mat up into the joist cavity.



2. If the mat begins near the rim joist, measure about 6" out from that rim joist. This will allow enough room for the mat power leads, and will prevent unnecessary heating of the wall cavity above the floor.



3. Measure 2" below the subfloor and mark the joists on both sides of the joist cavity.



4. To help hold up the power leads while installing the mat, fasten one NailTite over the power leads



5. Hold the mat up along one joist and begin stapling the mat mesh along the 2" mark from the subfloor. Staple every 4" to 6" for about 2 ft. to get started.





**6.**

**6.** At the other end of the mat, place a nail into the joist at 2" below the sub-floor. Hang the fiber mesh of the mat onto the nail. This will make it much easier to staple the rest of the mat.



**7.**

**7.** Continue stapling the mat mesh at 2" below the sub-floor, every 4" to 6". Then remove the nail at the end that held it up.



**8.**

**8.** Raise the mat to the other joist and staple the mat mesh 2" below the sub-floor.



**9.**

**9.** Using the same techniques, staple up all other mats.

### Power Lead Installation

If not already done so, mount a junction box below the subfloor within reach of the mat power leads. Install more than one junction box, if needed, for larger jobs. **The junction box must remain accessible** in accordance with electrical codes, so consider the location of the junction box carefully should the ceiling be finished after installation of the mat(s).

Route the power leads from the mat(s) to the junction box following all electrical and building codes using

conduit and additional electrical boxes where required.

For multiple mats, follow all electrical codes concerning "box fill" maximums. Connect the leads in parallel (black-to-black, white-to-white), and not in series.

Connect the mat leads to the power drop from the control electrical box or SunStat Relay.

Again, do not overload the control. The SunStat and SunStat Relay controls must not be loaded with over 15 amps of mats.

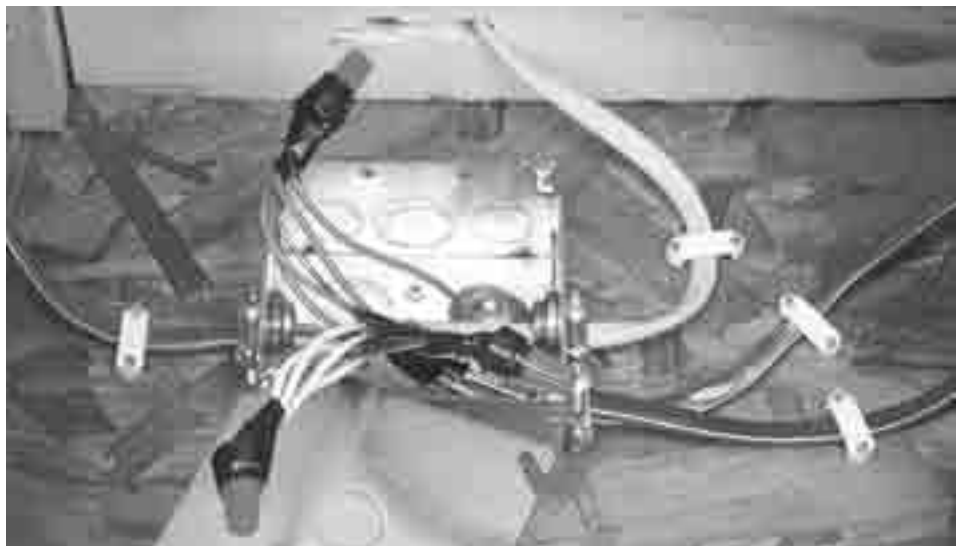

**Junction box with multiple sets of mat lead wires, connected in parallel, and connected to the power supply.**

## PART 4: Final Wiring

### Install the Control

Install the control(s) for the mats according to the wiring diagrams provided with the controls. See the diagrams are shown on pages 11–13.

Connect the power supply leads, the power drop to the mat junction box, and the floor sensor wire to the SunStat. Follow proper wiring procedures.

It is a good idea to overwrap the wire nuts with electrical tape to further secure the wires into the wires nuts before pushing the control back into the electrical box.

If a SunStat Relay is used, connect the power supply leads and power drop for the mats to the relay. Run a 2-wire 22-gauge or 24-gauge wire, or similar low-voltage cable, to connect the Relay(s) to the master SunStat. Connect the floor sensor wire to the

master SunStat.master control.

### Test the System

After the controls are installed and connected, energize the system briefly to test operation of all components.

Refer to the installation sheets provided with the SunStat for proper setting.

Without floor insulation, the mat will not heat the floor. When the SunStat calls for heat to the mat, the mat will begin to feel warm to the touch within 1 to 2 minutes or so. If this does not occur, recheck the SunStat settings, wiring connections, and power supply.

### Apply the Warning Label

Apply the Radiant Heating Warning Label (pg. 5) to the control or nearby location.

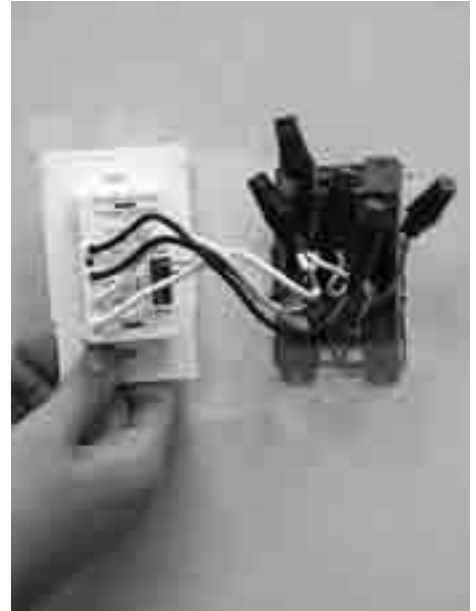

The mat power leads and sensor wire connected to the control at the electrical box.

## PART 5: Install the Insulation

Install R-13 to R-19 fiberglass insulation below the mat. Gently press the insulation up to the mat for best results and secure in place with rods, staples, or other method. A gap between the insulation and mat is acceptable but will not give the best heating results.

Make sure to insulate at the end of **all** heated joist cavities. Install insulation vertically in these areas to **seal** the ends of the heated joist areas or, 6" after the mat "stops" in a joist space, push the insulation up tight against the subfloor and staple to the subfloor. This ensures that no heated air can escape from the heated joist space. If this is not done, much heat will "escape" horizontally through band joists, rim joists, exterior walls, and open ends of joist spaces, and the floor will not warm as it should.

Seal openings around pipes, waste lines, ducts, joist blocking, and all other gaps with silicone caulking or urethane foam.



**REMEMBER:** Proper insulating and sealing of the floor cavity is necessary for the performance of SunTouch UnderFloor mats.

# PART 6: Wiring Diagrams

## Typical Electric Wiring Diagram with SunStat Control (120V/240V)

Dedicated 120-V, 20-amp (maximum) circuit for 120V mats ,or dedicated 240V, 20-amp (maximum) circuit for 240V mats (must be GFCI protected unless a GFCI SunStat is used).

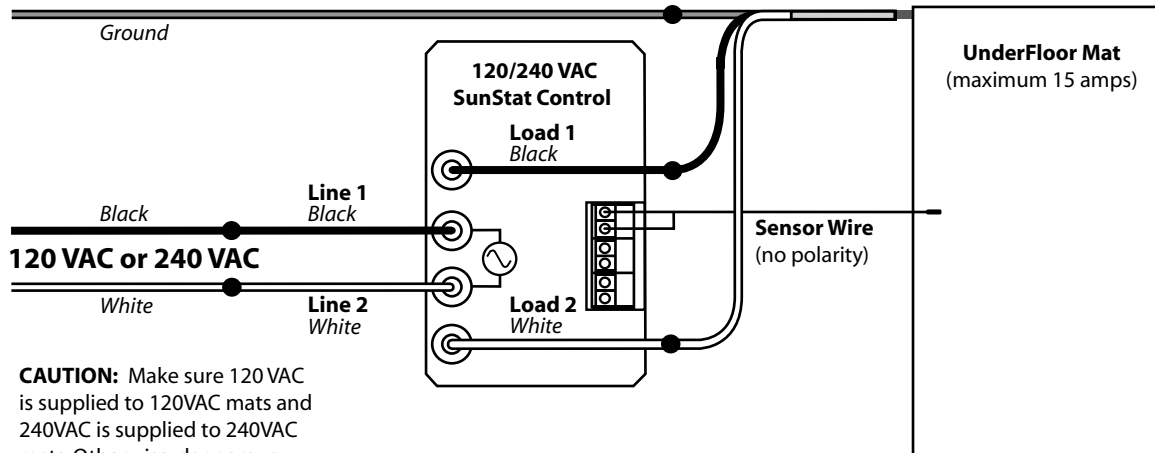

**CAUTION:** Make sure 120 VAC is supplied to 120VAC mats and 240VAC is supplied to 240VAC mats. Otherwise, dangerous overheating and possible fire hazard can result.

### Connecting two mats

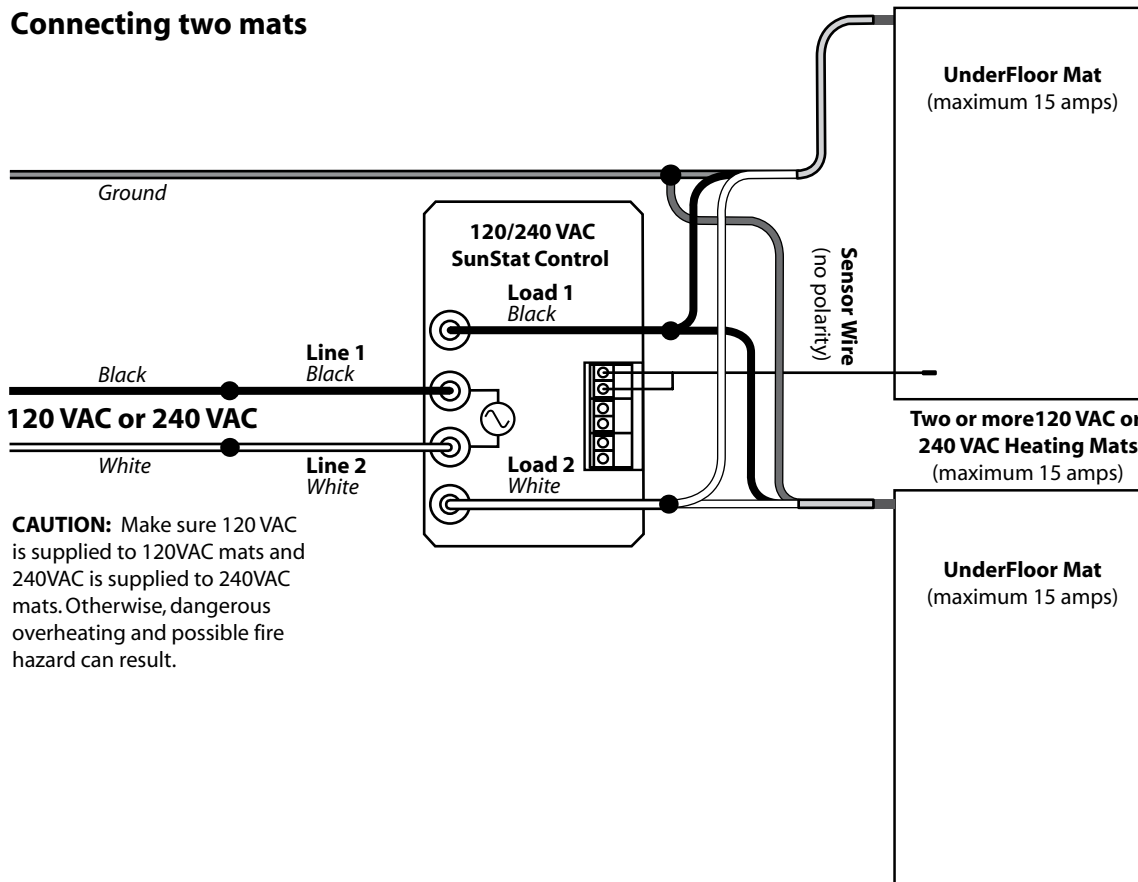

**CAUTION:** Make sure 120 VAC is supplied to 120VAC mats and 240VAC is supplied to 240VAC mats. Otherwise, dangerous overheating and possible fire hazard can result.

All electrical work must be done by a qualified licensed electrician in accordance with local building and electrical codes, and the National Electrical Code (NEC), especially Article 424, Part IX of the NEC, ANSI/NFPA70 and Section 62 of CEC Part 1.

## SunStat and Relay Connection Diagrams

Dedicated 120-V, 20-amp (maximum) circuit for 120V mats ,or dedicated 240V, 20-amp (maximum) circuit for 240V mats (must be GFCI protected unless a GFCI SunStat is used).

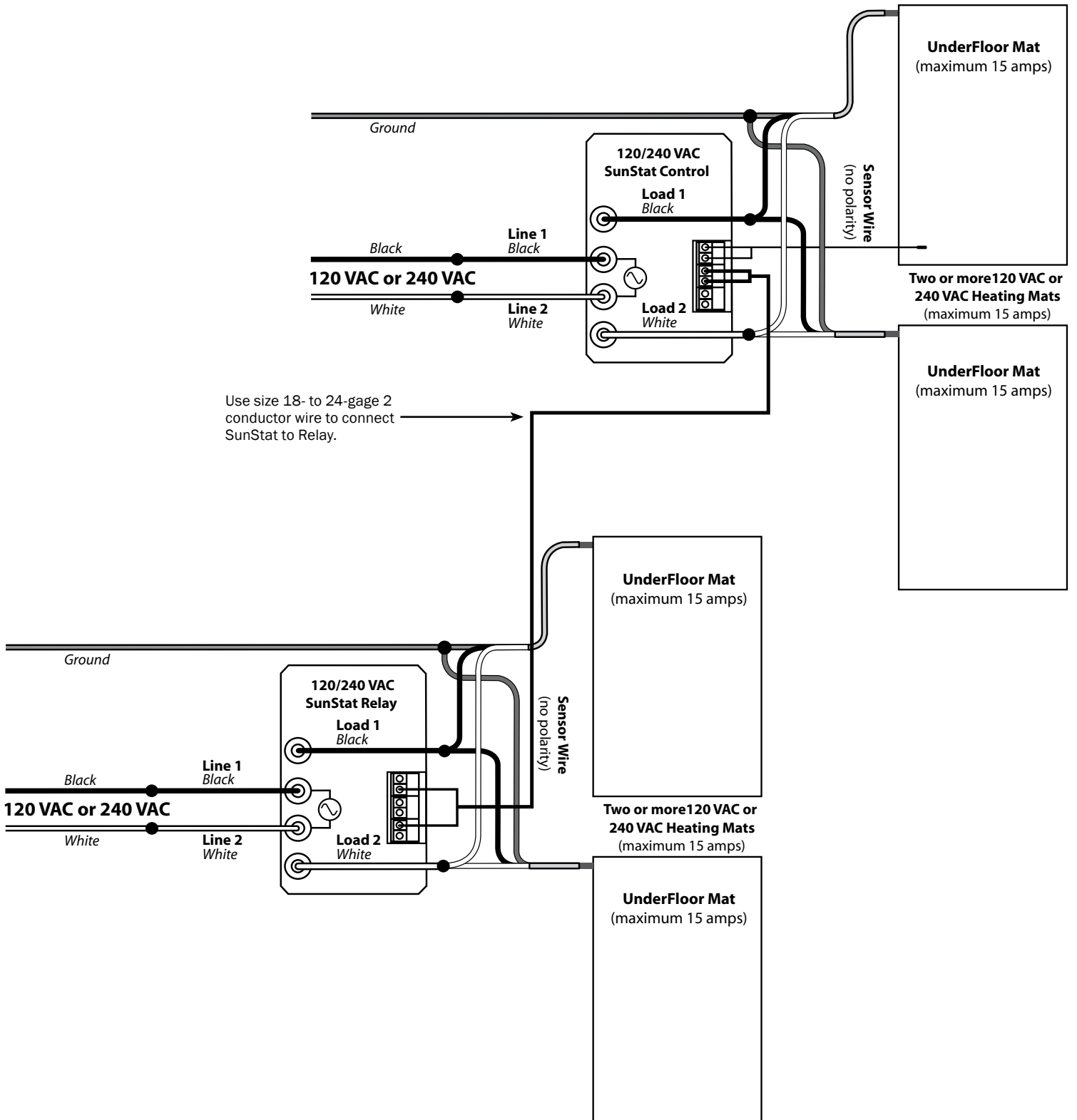

All electrical work must be done by a qualified licensed electrician in accordance with local building and electrical codes, and the National Electrical Code (NEC), especially Article 424, Part IX of the NEC, ANSI/NFPA70 and Section 62 of CEC Part 1.



### Diagram for connection of signal wire between SunStat and Relays

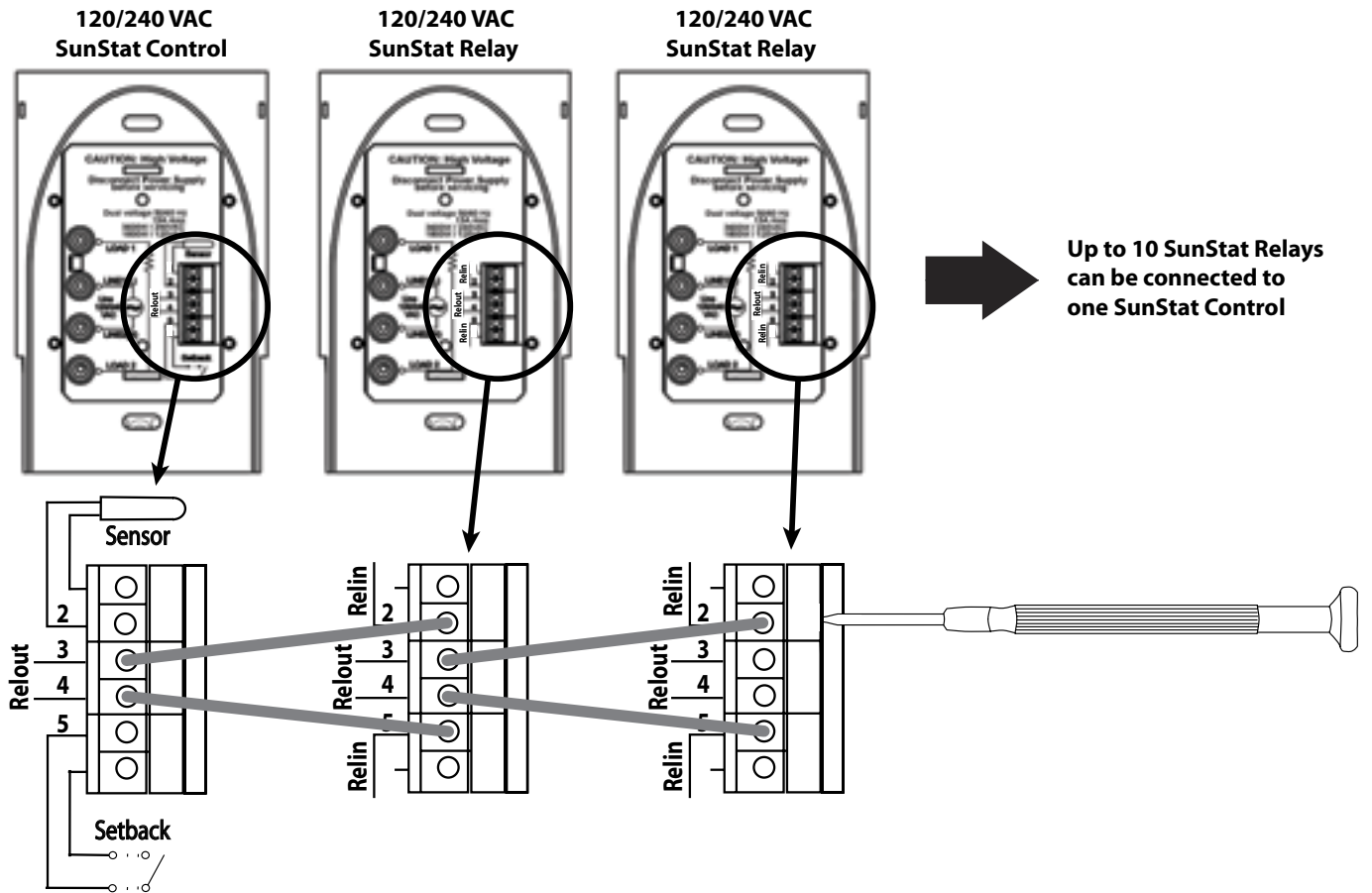

All electrical work must be done by a qualified licensed electrician in accordance with local building and electrical codes, and the National Electrical Code (NEC), especially Article 424, Part IX of the NEC, ANSI/NFPA70 and Section 62 of CEC Part 1.

## How to Connect the LoudMouth Monitor to the Mat Power Leads

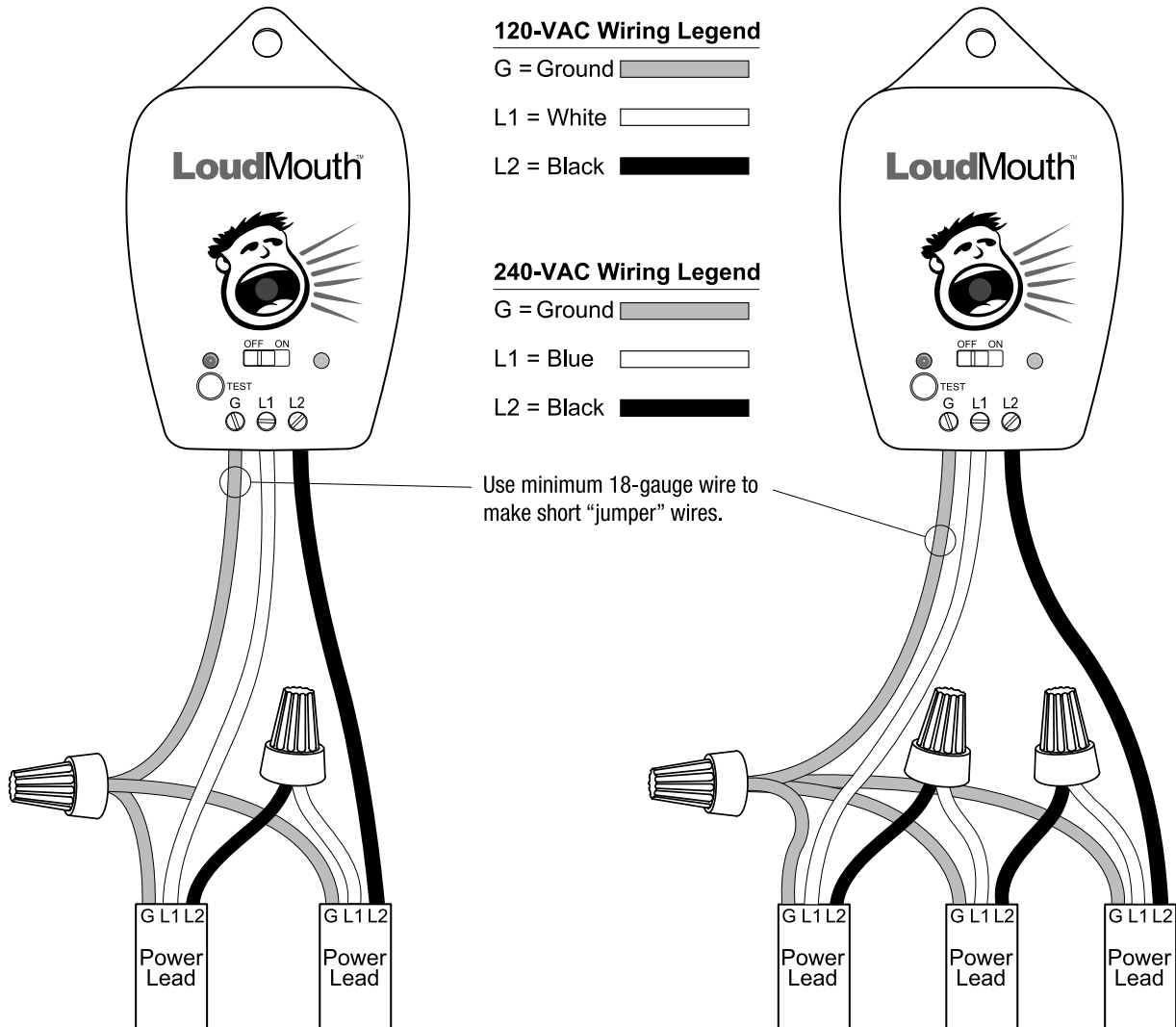

Illustrations showing how to connect the LoudMouth monitor to two mats (left), and how to connect the LoudMouth to three mats (right). The LoudMouth can monitor no more than three mats simultaneously. Do NOT leave the power leads connected in "series" like this when making final wiring connections; the mats will not heat sufficiently. When making final wiring connections, mats must be wired in parallel.

# PART 7: Troubleshooting Guide

If problems arise with the SunTouch UnderFloor mat or its related electrical components, please consult this troubleshooting guide. If not qualified to perform electrical work, it is highly recommended that a qualified, licensed electrician be hired.

Any electrical troubleshooting work should be performed with the power removed from the circuit, unless otherwise noted.

Although this troubleshooting guide is provided to assist with problems experienced with a SunTouch floor-

warming system, results are never guaranteed. SunTouch does not assume any liability or responsibility for damage or injury that may occur from using this guide.

If problems with the system persist, call the manufacturer at 888-432-8932.

Problem	Possible Cause	Solution
<b>Mat resistance measurement is outside the range printed on the nameplate label.</b>	An analog ohmmeter (using a moving needle) was used to take the reading.	Obtain a digital ohmmeter able to read 0 to 20,000 ohms and remeasure the resistance.
	If measurement shows an open or short circuit, the heating wire has been damaged.	Record resistance between all wires and contact the manufacturer.
	If measurement is just a little low or high, room temperature has affected the resistance.	Make the room temperature 75°–85°F, or contact the manufacturer.
	The mat may be wired in series or “daisy chained” with another mat, or may be wired in parallel with another mat. Either will provide false resistance readings.	Make sure resistance measurements are for only one mat at a time. Disconnect any other mats.
<b>Floor is not getting warm.</b>	Mat heating wire has been damaged.	Measure mat resistance. Check for both “open circuit” and “short circuit” as detailed earlier in this manual. If damaged, record resistances between all wires and contact the manufacturer.
	GFCI has tripped, indicated by a light on the control. Light may be labeled “GFI,” may be below the words “Stand by,” or on the button labeled “Test.”	Check for loose wire connections. Reset the GFCI on the control or circuit breaker. If it trips again, check for a short circuit in the mat as detailed earlier in this manual. If mat is damaged, record resistance between all wires and contact the manufacturer. If mat is not damaged, replace the GFCI control. Also see “GFCI conflicts” below.
	Incorrect voltage supplied, or mismatched electrical components used.	Measure “line” voltage, then measure “load” voltage. Both 120-V mats and controls have black and white leads. 240-V mats have black and blue leads.
	Mats are wired in “series” or “daisy chained” (end-to-end).	Multiple mats must be connected in “parallel” (or black-to-black, white-to-white).
<b>Floor heats continuously.</b>	Floor sensor is loose or broken. If control has a digital display, it may indicate “LO.”	Pull the sensor wires loose from the control and reinsert them. If this does not solve the problem, loosen the sensor wires from the control and measure resistance across the sensor wires. For a SunTouch control sensor the resistance should be between 17,000 ohms (at 55°F/13°C) and 8,000 ohms (at 85°F/29°C). See sensor wire resistance values on page 6.
	Incorrect wiring. The control was “bypassed” when it was wired to the power supply.	Make sure wiring connections are correct. Consult the wiring diagram on the back of the control, the instructions that came with the control, or the wiring diagrams in Part 6 of this manual to make sure the four connections are correct.
	Defective control.	Return control to dealer for replacement.
<b>Control is not working correctly.</b>	If a programmable control, the programming may be incorrect.	Carefully read and follow control programming instructions.
	Incorrect voltage supplied, or mismatched components used.	Measure voltage at the control and make sure it matches the control voltage rating, and the mat voltage rating. Make sure electrical components are compatible. 120-V mats have black and white leads. 240-V mats have black and blue leads.
	Floor sensor is not wired properly, or is not working properly.	Make sure only one floor sensor is connected to the control. Also see “Sensor is loose or broken” above.
	Loose connection(s) on line side and/or load side of control.	Remove and reinstall the wire nuts at each connection. Make sure the wire nuts are tight. Check all connections back to the breaker.
<b>Control is not working at all.</b>	No power is supplied.	Check circuit breaker. Measure voltage at the control. Check all connections between breaker and control.
	Floor sensor is not wired properly, or is not working properly.	The control can only read the signal from a single floor sensor. Make sure only one floor sensor is connected to the control. Also see “Sensor is loose or broken” above.
	Defective control.	Return control to dealer for replacement.
<b>GFCI conflicts and false-trips.</b>	More than one GFCI on the circuit.	GFCI units will sometimes trip when there is nothing wrong with the equipment on the circuit, but when there is more than one GFCI on the same circuit. Reroute power to avoid having more than one GFCI on the circuit.
	Loose wiring connection(s).	Remove and reinstall the wire nuts at each connection. Make sure the wire nuts are tight. Check all connections back to the breaker.
	An electric motor or a ballasted light source is sharing the circuit with the control.	Electric motors and other electrical devices can cause a GFCI to false-trip. Run a dedicated circuit to the floor-warming system.

Mat layout grid — use this to draw a scaled layout of the room to be heated.

= \_\_\_\_\_

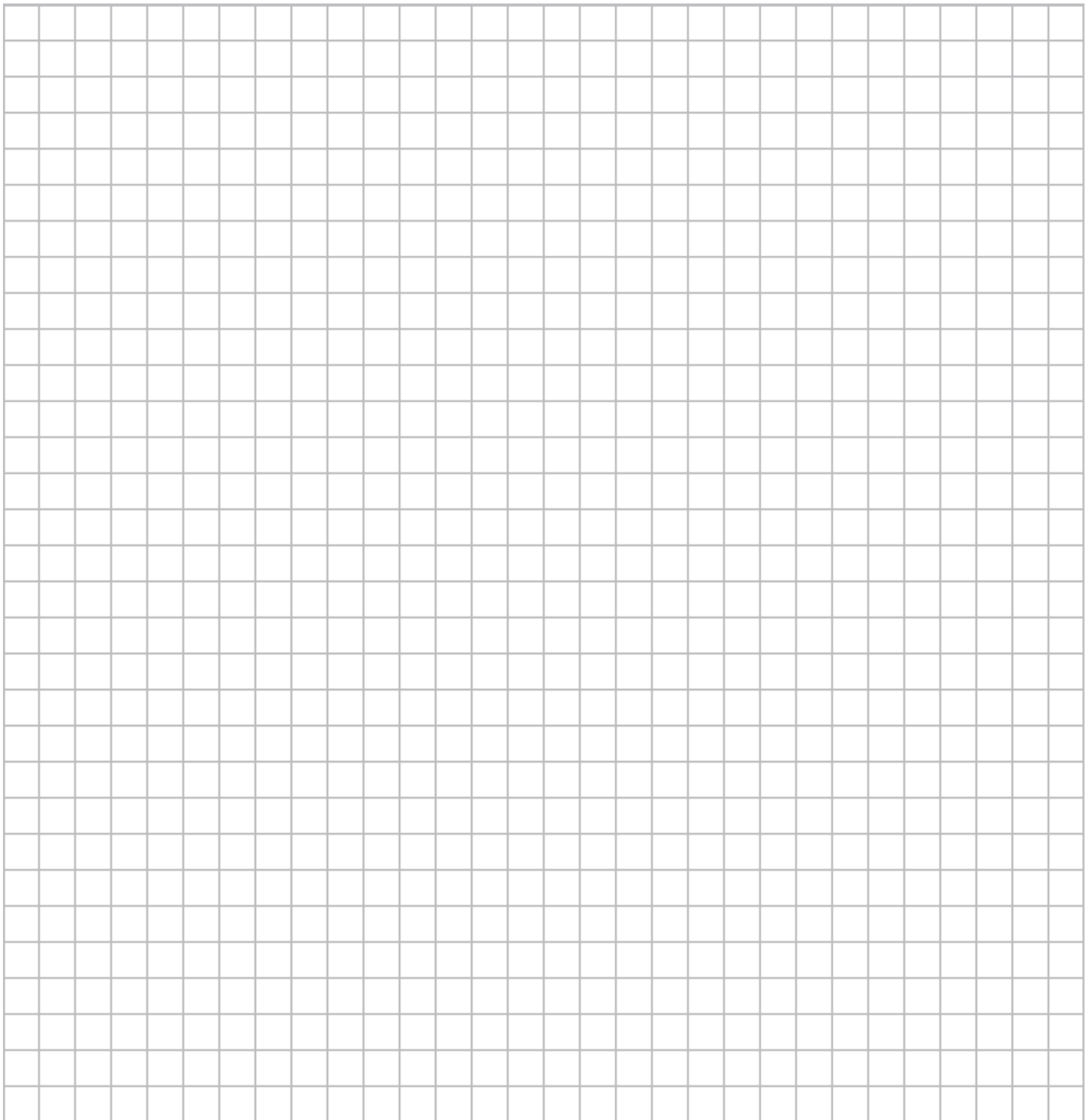

**4500 E. Progress Place**  
**Springfield, MO 65803-8816**  
**888-432-8932** (toll-free phone)  
**417-522-6128** (phone)  
**417-831-4067** (fax)  
**www.suntouch.com**

