

Air-Conditioners

SEZ-KD09,KD12,KD15,KD18NA4

INSTALLATION MANUAL

For safe and correct use, please read this installation manual thoroughly before installing the air-conditioner unit.

FOR INSTALLER

English

MANUEL D'INSTALLATION

Veuillez lire le manuel d'installation en entier avant d'installer ce climatiseur pour éviter tout accident et vous assurer d'une utilisation correcte.

POUR L'INSTALLATEUR

Français

[Fig. 3-1]

(Unit: mm [in])

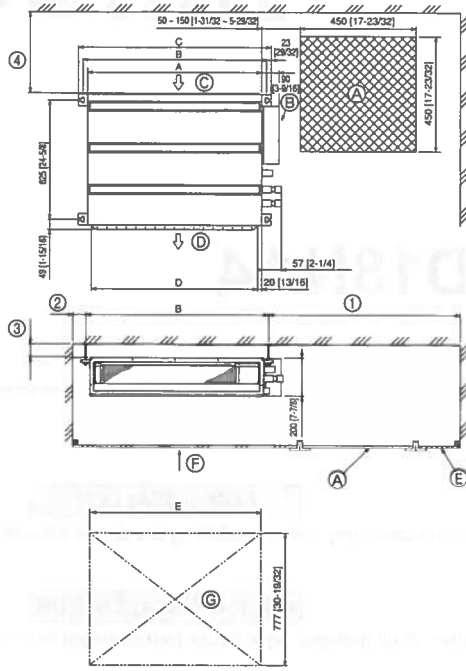

- Ⓐ Access door
- Ⓑ Electrical parts box
- Ⓒ Air inlet
- Ⓓ Air outlet
- Ⓔ Ceiling surface
- Ⓕ Service space (viewed from the side)
- Ⓖ Service space (viewed from the direction of arrow)
- ① 600 mm [23-5/8 in] or more
- ② 100 mm [3-15/16 in] or more
- ③ 10 mm [13/32 in] or more
- ④ 300 mm [11-13/16 in] or more

(Unit: mm [in])

Model	A	B	C	D	E
SEZ-KD09NA4	700 [27-9/16]	752 [29-5/8]	798 [31-7/16]	660 [26]	800 [31-1/2]
SEZ-KD12, 15NA4	900 [35-7/16]	952 [37-1/2]	998 [39-5/16]	860 [33-7/8]	1000 [39-3/8]
SEZ-KD18NA4	1100 [43-5/16]	1152 [45-3/8]	1198 [47-3/16]	1060 [41-3/4]	1200 [47-1/4]

[Fig. 4-1]

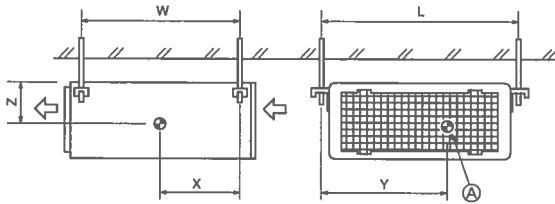

Ⓐ Center of gravity

[Fig. 5-1]

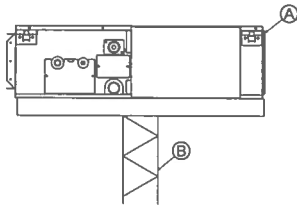

- Ⓐ Unit
- Ⓑ Lifting machine

[Fig. 5-2]

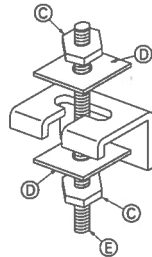

- Ⓒ Nuts (field supplied)
- Ⓓ Washers (accessory)
- Ⓔ M10 hanging bolt (field supplied)

[Fig. 5-3]

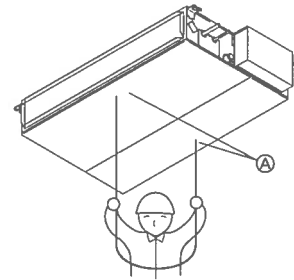

Ⓐ Indoor unit's bottom surface

[Fig. 6-1]

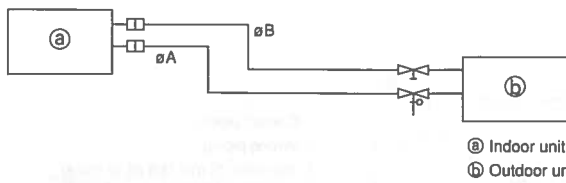

(Unit: mm [in])

Model	A	B
SEZ-KD09, 12NA4	9.52 [3/8]	6.35 [1/4]
SEZ-KD15NA4	12.7 [1/2]	6.35 [1/4]
SEZ-KD18NA4	12.7 [1/2]	6.35 [1/4]

Ⓐ Indoor unit
Ⓑ Outdoor unit

6.2

[Fig. 6-3]

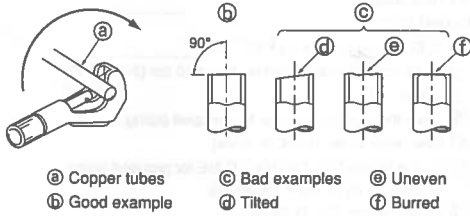

Ⓐ Copper tubes
Ⓑ Good example
Ⓒ Bad examples
Ⓓ Tilted
Ⓔ Uneven
Ⓕ Burred

[Fig. 6-4]

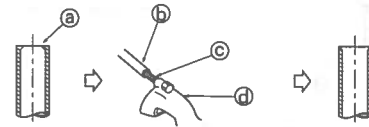

Ⓐ Burr
Ⓑ Copper tube/pipe
Ⓒ Spare reamer
Ⓓ Pipe cutter

[Fig. 6-5]

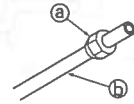

Ⓐ Flare nut
Ⓑ Copper tube

[Fig. 6-6]

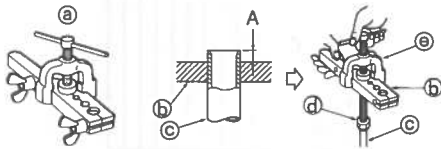

Ⓐ Flaring tool
Ⓑ Die
Ⓒ Copper tube
Ⓓ Flare nut
Ⓔ Yoke

[Fig. 6-7]

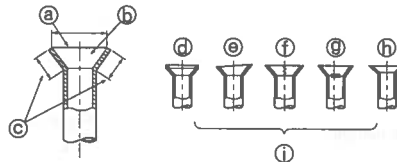

Ⓐ Smooth
Ⓑ Inside is shiny without any scratches
Ⓒ Even length
Ⓓ Too much
Ⓔ Tilted
Ⓕ Scratch on flared plane
Ⓖ Cracked
Ⓗ Uneven
Ⓘ Bad examples

6.3

[Fig. 6-8]

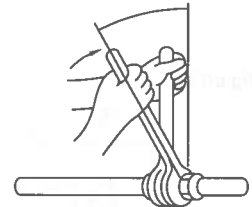

[Fig. 6-9]

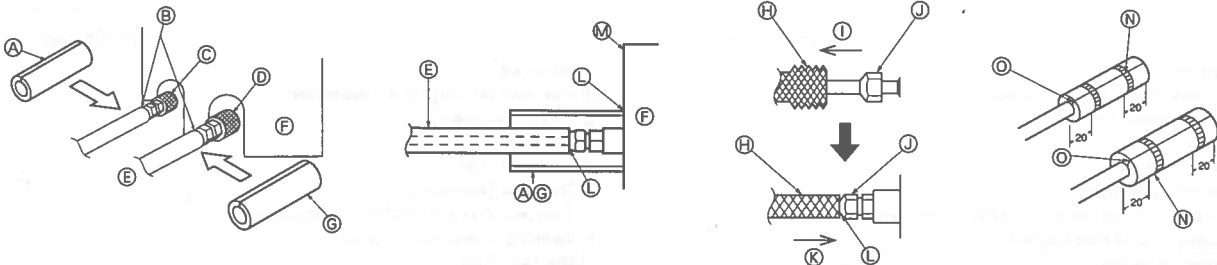

Ⓐ Pipe cover (120 mm [3/4 in] small diameter) (accessory)
 Ⓑ Caution:
 Pull out the thermal insulation on the refrigerant piping at the site, insert the flare nut to flare the end, and reinsert the insulation.
 Take care to ensure that condensation does not form on exposed copper piping.
 Ⓒ Liquid end of refrigerant piping
 Ⓓ Gas end of refrigerant piping
 Ⓔ Site refrigerant piping
 Ⓕ Main body
 Ⓖ Pipe cover (120 mm [3/4 in] large diameter) (accessory)
 Ⓗ Thermal insulation (field supplied)
 Ⓘ Pull
 Ⓙ Flare nut
 Ⓚ Return to original position
 Ⓛ Ensure that there is no gap here
 Ⓜ Plate on main body
 Ⓝ Tie band (accessory)
 Ⓞ Ensure that there is no gap here. Point joint upwards.

6.5

[Fig. 6-10]

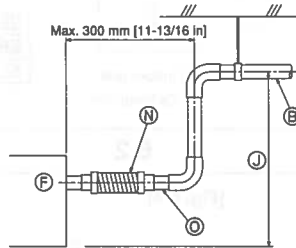
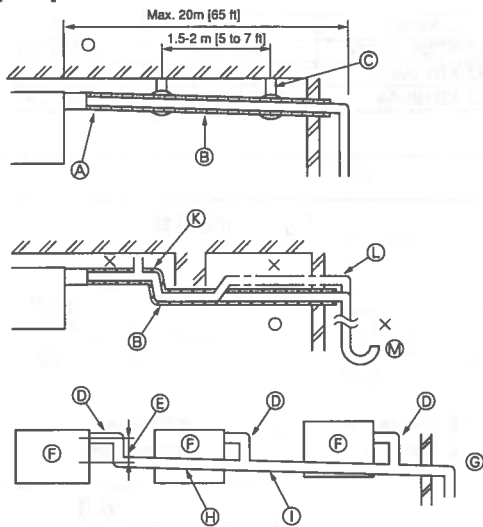

- Correct piping
 - × Wrong piping
 - Ⓐ Insulation (9 mm [3/8 in] or more)
 - Ⓑ Downward slope (1/100 or more)
 - Ⓒ Support metal
 - Ⓚ Air bleeder
 - Ⓛ Raised
 - Ⓜ Odor trap
- Grouped piping**
- Ⓓ O. D. $\phi 32$ mm [1-1/4 in] PVC TUBE
 - Ⓔ Make it as large as possible. About 10 cm [3-15/16 in].
 - Ⓕ Indoor unit
 - Ⓖ Make the piping size large for grouped piping.
 - Ⓗ Downward slope (1/100 or more)
 - Ⓣ O. D. $\phi 38$ mm [1-1/2 in] PVC TUBE for grouped piping. (9 mm [3/8 in] or more insulation)
 - Ⓝ Up to 550 mm [21-21/32 in]
 - Ⓜ Drain hose (accessory)
 - Ⓞ Horizontal or slightly upward

[Fig. 6-11]

(Unit: mm [in])

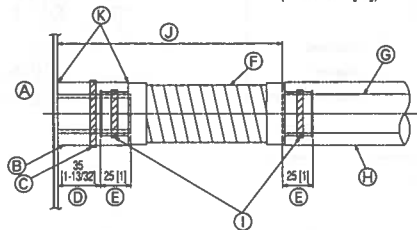

- Ⓐ Indoor unit
- Ⓑ Pipe cover (60 mm [3/8 in]) (accessory)
- Ⓒ Tie band (accessory)
- Ⓓ Visible part
- Ⓔ Insertion margin
- Ⓕ Drain hose (accessory)
- Ⓖ Drain pipe (O.D. $\phi 32$ mm [1-1/4 in] PVC TUBE, field supplied)
- Ⓗ Insulating material (field supplied)
- Ⓣ Tie band (accessory)
- Ⓝ Max. 180 ± 5 mm [7-3/32 \pm 7/32 in]
- Ⓞ No gap. The joint section of the insulation material must meet at the top.

[Fig. 6-12]

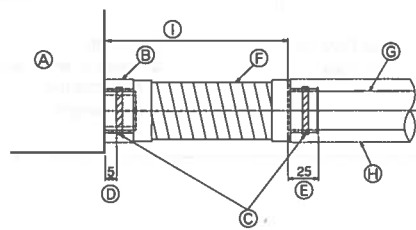

- Ⓐ Indoor unit
- Ⓑ Pipe cover (30 mm [3/16 in]) (accessory)
- Ⓒ Tie band (accessory)
- Ⓓ Band fixing part
- Ⓔ Insertion margin
- Ⓕ Drain hose (accessory)
- Ⓖ Drain pipe (O.D. $\phi 32$ PVC TUBE, field supplied)
- Ⓗ Insulating material (field supplied)
- Ⓣ Max. 145 ± 5 mm

6.6

[Fig. 6-13]

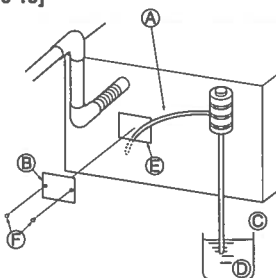

- Ⓐ Insert pump's end 2 to 4 cm [13/16 to 1-19/32 in].
- Ⓑ Remove the water supply port.
- Ⓒ About 2 liters
- Ⓓ Water
- Ⓔ Filling port
- Ⓕ Screw

[Fig. 6-14]

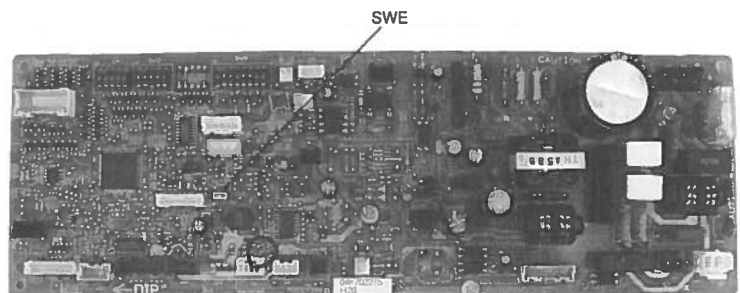

<Indoor board>

7

[Fig. 7-1]

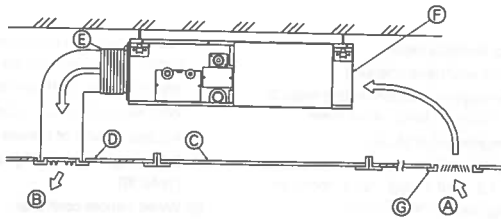

- Ⓐ Air inlet
- Ⓑ Air outlet
- Ⓒ Access door
- Ⓓ Ceiling
- Ⓔ Canvas duct
- Ⓕ Air filter
- Ⓖ Inlet grille

8

8.1

[Fig. 8-1]

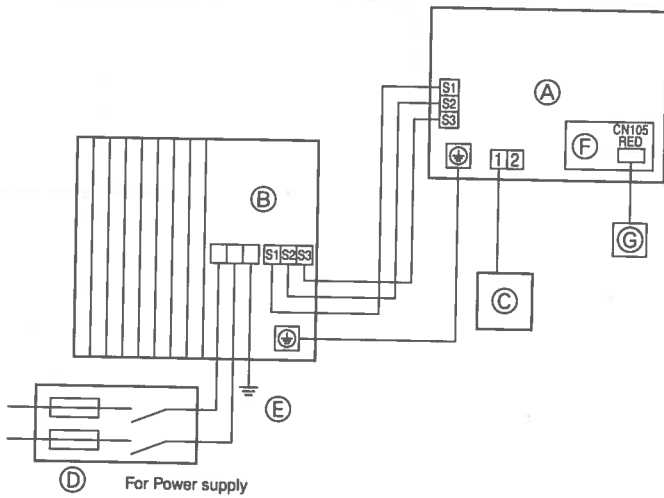

- Ⓐ Indoor unit
- Ⓑ Outdoor unit
- Ⓒ Wired remote controller
- Ⓓ Main switch/fuse
- Ⓔ Ground wire
- Ⓕ Indoor controller board
- Ⓖ Radio frequency interface for RF thermostat

8.2

[Fig. 8-2-1]

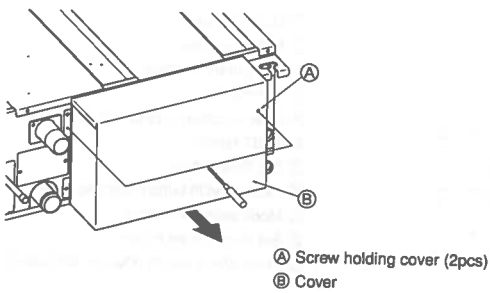

- Ⓐ Screw holding cover (2pcs)
- Ⓑ Cover

[Fig. 8-2-2]

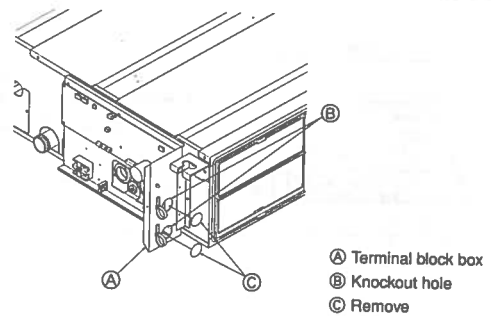

- Ⓐ Terminal block box
- Ⓑ Knockout hole
- Ⓒ Remove

[Fig. 8-2-3]

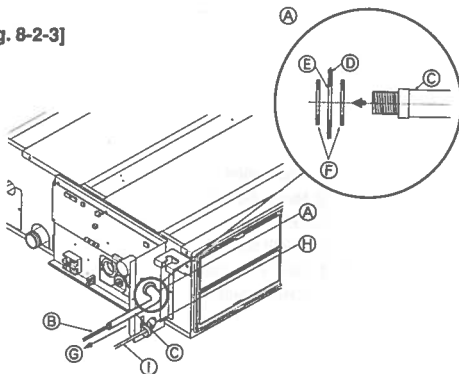

- Ⓐ Use conduit to keep the weight of the cable and external force from being applied to the power supply terminal connector.
- Ⓑ Indoor/outdoor unit connecting cable
- Ⓒ Conduit
- Ⓓ Terminal block box
- Ⓔ Knockout hole (for indoor/outdoor unit connecting cable)
- Ⓕ Washer (accessory)
- Ⓖ Tensile force
- Ⓗ Use ordinary bushing
- Ⓘ Wired remote controller cable or wiring for radio interface

[Fig. 8-2-4]

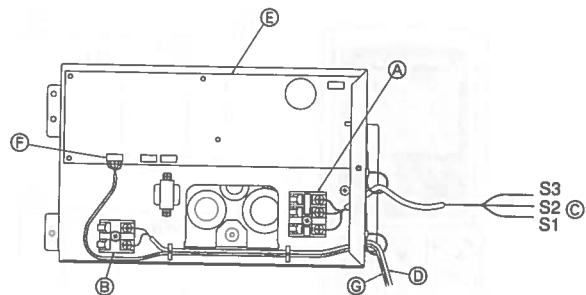

- Ⓐ Terminal block for indoor/outdoor unit connecting
- Ⓑ Terminal block for wired remote controller
- Ⓒ Indoor/outdoor unit connecting cable
- Ⓓ Wired remote controller cable
- Ⓔ Indoor controller board
- Ⓕ CN105 (RED/5P)
- Ⓖ Wiring for radio interface

8.2

[Fig. 8-3]

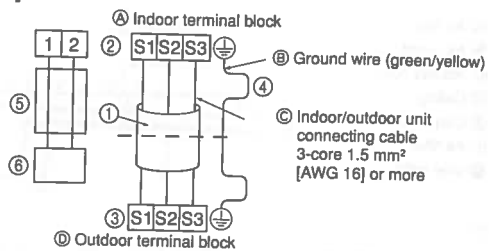

- ① Indoor terminal block
- ② Ground wire (green/yellow)
- ③ Indoor/outdoor unit connecting cable 3-core 1.5 mm² [AWG 16] or more
- ④ Outdoor terminal block
- ⑤ Indoor/outdoor unit connecting cable 3-core 1.5 mm² [AWG 16] or more, following Design 245 IEC 57.
- ⑥ Outdoor terminal block
- ④ Always install an ground wire (1-core 1.5 mm² [AWG 16]) longer than other cables
- ⑤ Wired remote controller cable
Wire No × size (mm²) : Cable 2C × 0.3
Accessory wire of remote controller
(wire length : 10m [32 ft], non-polar. Max. 500 m [1640 ft])
- ⑥ Wired remote controller

8.3

[Fig. 8-4]

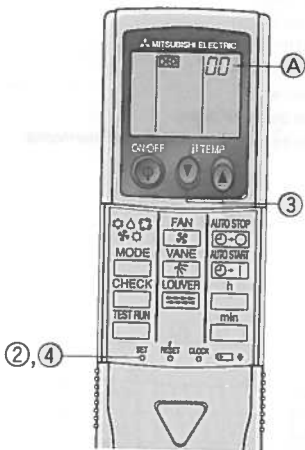

8.4

[Fig. 8-5]

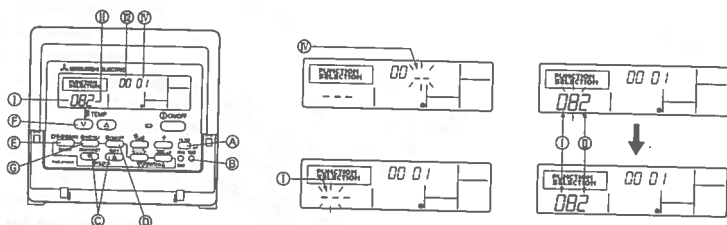

- ① Mode number
- ② Setting number
- ③ Refrigerant address
- ④ Unit number
- A Filter ↓ button (<Enter> button)
- B TEST button
- C Set Time button
- D Timer On/Off button (Set Day button)
- E Mode selection button
- F Set temperature button
- G Timer Menu button (Monitor/Set button)

[Fig. 8-6]

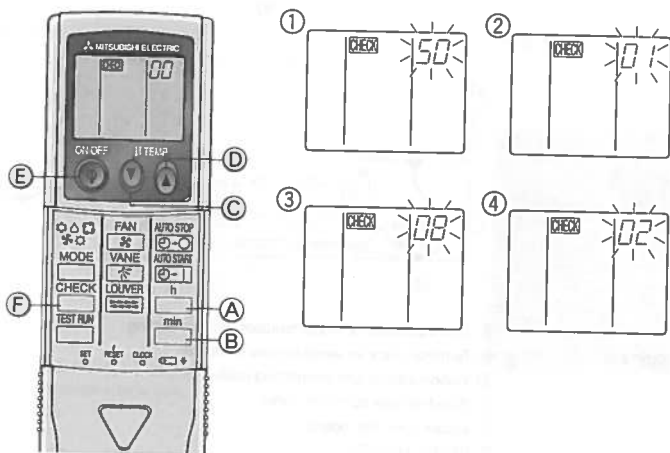

- A Hour button
- B Minute button
- C TEMP button
- D TEMP button
- E ON/OFF button
- F CHECK button

[Fig. 11-1]

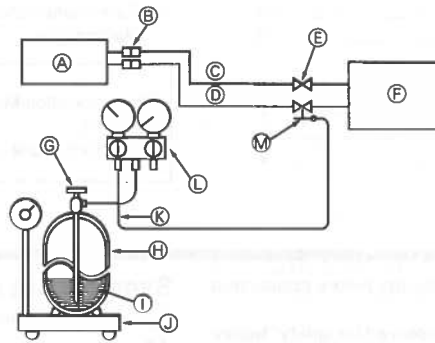

- Ⓐ Indoor unit
- Ⓑ Union
- Ⓒ Liquid pipe
- Ⓓ Gas pipe
- Ⓔ Stop valve
- Ⓕ Outdoor unit
- Ⓖ Refrigerant gas cylinder operating valve
- Ⓗ Refrigerant gas cylinder for R410A with siphon
- Ⓘ Refrigerant (liquid)
- Ⓝ Electronic scale for refrigerant charging
- Ⓚ Charge hose (for R410A)
- Ⓛ Gauge manifold valve (for R410A)
- Ⓜ Service port

Contents

1. Safety precautions	8	9. Test run	14
2. Selecting the installation location	8	10. Easy maintenance function	16
3. Selecting an installation site & accessories	9	11. Maintenance	16
4. Fixing hanging bolts	9		
5. Installing the unit	9		
6. Refrigerant piping work	10		
7. Duct work	12		
8. Electrical work	12		

This Installation Manual only applies to the indoor unit and the SUZ series outdoor unit.
If the outdoor unit is MXZ series, refer to the Installation Manual for MXZ series.

1. Safety precautions

- Please report to or take consent by the supply authority before connection to the system.
- Be sure to read "The following should always be observed for safety" before installing the air conditioner.
- Be sure to observe the cautions specified here as they include important items related to safety.
- The indications and meanings are as follows.

⚠ Warning:

Could lead to death, serious injury, etc.

⚠ Caution:

Could lead to serious injury in particular environments when operated incorrectly.

- After reading this manual, be sure to keep it together with the instruction manual in a handy place on the customer's site.

⚠ Warning:

- Do not use refrigerant other than the type indicated in the manuals provided with the unit and on the nameplate.
 - Doing so may cause the unit or pipes to burst, or result in explosion or fire during use, during repair, or at the time of disposal of the unit.
 - It may also be in violation of applicable laws.
 - MITSUBISHI ELECTRIC CORPORATION cannot be held responsible for malfunctions or accidents resulting from the use of the wrong type of refrigerant.
- When handling this product, always wear protective equipment.
EG: Gloves, full arm protection namely boiler suit, and safety glasses.
 - Improper handling may result in injury.
- Do not install it by yourself (customer).
Incomplete installation could cause injury due to fire, electric shock, the unit falling or leakage of water. Consult the dealer from whom you purchased the unit or special installer.
- Install the unit securely in a place which can bear the weight of the unit.
When installed in an insufficient strong place, the unit could fall causing injured.
- Use the specified wires to connect the indoor and outdoor units securely and attach the wires firmly to the terminal board connecting sections so the stress of the wires is not applied to the sections.
Incomplete connecting and fixing could cause fire.

⚠ Caution:

- Ground the unit.
Do not connect the ground wire to a gas pipe, water pipe arrester or telephone ground wire. Defective grounding could cause an electric shock.
- Do not install the unit in a place where an inflammable gas leaks.
If gas leaks and accumulates in the area surrounding the unit, it could cause an explosion.
- Install a ground leakage breaker depending on the installation place (where it is humid).
If a ground leakage breaker is not installed, it could cause an electric shock.

2. Selecting the installation location

2.1. Indoor unit

- Where airflow is not blocked.
- Where cool air spreads over the entire room.
- Where it is not exposed to direct sunshine.
- At a distance 1 m [39-3/8 in] or more away from a TV and radio (to prevent picture from being distorted or sound from being generated).

2.2. Outdoor unit

- Where it is not exposed to strong wind.
- Where airflow is good and dustless.
- Where it is not exposed to rain and direct sunshine.
- Where neighbours are not annoyed by operation sound or hot air.
- Where rigid wall or support is available to prevent the increase of operation sound or vibration.
- Where there is no risk of combustible gas leakage.
- When installing the unit at a high level, be sure to fix the unit legs.
- Where it is at least 3 m [10 ft] away from the antenna of TV set or radio. (Otherwise, images would be disturbed or noise would be generated.)

Symbols put on the unit

- ⊘ : Indicates an action that must be avoided.
- ⓘ : Indicates that important instructions must be followed.
- ⚡ : Indicates a part which must be grounded.
- ⚠ : Indicates that caution should be taken with rotating parts.
- ⚡ : Indicates that the main switch must be turned off before servicing.
- ⚠ : Beware of electric shock.
- ⚠ : Beware of hot surface.

⚠ Warning:

Carefully read the labels affixed to the main unit.

- Do not use intermediate connection of the power cord or the extension cord and do not connect many devices to one AC outlet.
It could cause a fire or an electric shock due to defective contact, defective insulation, exceeding the permissible current, etc.
- Check that the refrigerant gas does not leak after installation has completed.
- Perform the installation securely referring to the installation manual.
Incomplete installation could cause a personal injury due to fire, electric shock, the unit falling or leakage of water.
- Perform electrical work according to the installation manual and be sure to use an exclusive circuit.
If the capacity of the power circuit is insufficient or there is incomplete electrical work, it could result in a fire or an electric shock.
- Attach the electrical part cover to the indoor unit and the service panel to the outdoor unit securely.
If the electrical part cover in the indoor unit and/or the service panel in the outdoor unit are not attached securely, it could result in a fire or an electric shock due to dust, water, etc.
- Be sure to use the part provided or specified parts for the installation work.
The use of defective parts could cause an injury or leakage of water due to a fire, an electric shock, the unit falling, etc.
- Ventilate the room if refrigerant leaks during operation.
If the refrigerant comes in contact with a flame, poisonous gases will be released.
- Perform the drainage/piping work securely according to the installation manual.
If there is a defect in the drainage/piping work, water could drop from the unit and household goods could be wet and damaged.
- Fasten a flare nut with a torque wrench as specified in this manual.
When fastened too tight, a flare nut may broken after a long period and cause a leakage of refrigerant.

- In a place as far away as possible from fluorescent and incandescent lights (so the infrared remote control can operate the air conditioner normally).
- Where the air filter can be removed and replaced easily.

⚠ Warning:

Mount the indoor unit into a ceiling strong enough to withstand the weight of the unit.

- Install the unit horizontally.

⚠ Caution:

Avoid the following places for installation where air conditioner trouble is liable to occur.

- Where there is too much machine oil in the air.
- Salty environments as seaside areas.
- Hot-spring areas.
- Where sulfide gas exists.
- Other special atmospheric areas.

3. Selecting an installation site & accessories

- Select a site with sturdy fixed surface that is strong enough to support the weight of unit.
- Before installing unit, the routing to carry in unit to the installation site should be determined.
- Select a site where the unit is not affected by entering air.
- Select a site where the flow of supply and return air is not blocked.
- Select a site where refrigerant piping can easily be installed to the outside.
- Select a site which allows the supply air to be fully distributed in a room.
- Do not install unit at a site near a lot of oil or steam.
- Do not install unit at a site where combustible gas may generate, flow in, stagnate or leak.
- Do not install unit at a site where there is equipment generating high frequency waves (a high frequency wave welder for example).
- Do not install unit at a site where fire detector is located at the supply air side. (Fire detector may operate erroneously due to the heated air supplied during heating operation.)
- If there are chemicals in the area, such as chemical plants and hospitals, full investigation is required before installing unit. (The plastic components may be damaged depending on the chemical product applied.)
- If the unit runs for long hours when the air above the ceiling is at high temperature/high humidity (dew point above 79 °F [26 °C]), condensation may be produced in the indoor unit. Add insulation material (10-20 mm [13/32 to 13/16 in]) to the entire surface of the indoor unit to avoid condensation.

3.1. Install the indoor unit on a ceiling strong enough to sustain its weight

[Fig. 3-1] (P.2)

- Ⓐ Access door
- Ⓑ Electrical parts box
- Ⓒ Air inlet
- Ⓓ Air outlet
- Ⓔ Ceiling surface
- Ⓕ Service space (viewed from the side)
- Ⓖ Service space (viewed from the direction of arrow)
- ① 600 mm [23-5/8 in] or more
- ② 100 mm [3-15/16 in] or more
- ③ 10 mm [13/32 in] or more
- ④ 300 mm [11-13/16 in] or more

⚠ Warning:

The unit must be securely installed on a structure that can sustain its weight. If the unit is mounted on an unstable structure, it may fall down, causing injuries.

3.2. Securing installation and service space

- Select the optimum direction of supply airflow according to the configuration of the room and the installation position.
- As the piping and wiring are connected at the bottom and side surfaces, and the maintenance is made at the same surfaces, allow a proper space properly. For the efficient suspension work and safety, provide a space as much as possible.

3.3. Outdoor unit

Ventilation and service space

Units should be installed by licensed contractor accordingly to local code requirements.

For outdoor units to be connected, refer to the Installation Manual that comes with the units.

3.4. Indoor unit accessories

The unit is provided with the following accessories:

No.	Name	Quantity
①	Pipe cover (for refrigerant piping joint) 120 mm [3/4 in] Small diameter	1
②	Pipe cover (for refrigerant piping joint) 120 mm [3/4 in] Large diameter	1
③	Tie band	7
④	Washer (for hanging)	8
⑤	Drain hose	1
⑥	Pipe cover (for Drain hose) 60 mm [3/8 in]	1
⑦	Pipe cover (for Drain hose) 30 mm [3/16 in]	1
⑧	Washer (for power source wiring)	2

4. Fixing hanging bolts

4.1. Fixing hanging bolts

[Fig. 4-1] (P.2)

- Ⓐ Center of gravity

Hanging structure

- Ceiling: The ceiling structure varies from building to one another. For detailed information, consult the construction company.

Center of gravity and Product Weight

Model name	W (mm [in])	L (mm [in])	X (mm [in])	Y (mm [in])	Z (mm [in])	Product Weight (kg [lb])
SEZ-KD09NA4	625 [24-5/8]	752 [29-5/8]	263 [10-3/8]	351 [13-27/32]	106 [4-3/16]	19 [42]
SEZ-KD12NA4	625 [24-5/8]	952 [37-1/2]	286 [11-9/32]	448 [17-21/32]	104 [4-1/8]	22 [50]
SEZ-KD15NA4	625 [24-5/8]	952 [37-1/2]	280 [11-1/32]	437 [17-7/32]	104 [4-1/8]	24 [54]
SEZ-KD18NA4	625 [24-5/8]	1152 [45-3/8]	285 [11-1/4]	527 [20-3/4]	104 [4-1/8]	28 [62]

- If necessary, reinforce the hanging bolts to protect against earthquakes.
 - * Use M10 for hanging bolts and reinforcements to protect against earthquake (field supplied).
- ① Ceiling reinforcement (edge beam, etc.) must be required to keep the ceiling level and to prevent it from vibrating.
- ② Cut and remove the ceiling beams.
- ③ Reinforce the ceiling, and add other beams for fixing the ceiling boards.

5. Installing the unit

5.1. Hanging the unit

- ▶ Transport the indoor unit to the site in its original packing material.
- ▶ To hang the indoor unit, use a lifting machine to lift and pass through the hanging bolts.

[Fig. 5-1] (P.2)

- Ⓐ Unit
- Ⓑ Lifting machine

[Fig. 5-2] (P.2)

- Ⓒ Nuts (field supplied)
- Ⓓ Washers (accessory)
- Ⓔ M10 hanging bolt (field supplied)

5.2. Confirming the unit's position and attaching hanging bolts

- ▶ Use the gauge supplied with the panel to confirm that the unit and hanging bolts are positioned in place. If they are not positioned in place, it may condensate due to drafts. Be sure to check the position.
- ▶ Use a level to check that the surface indicated by Ⓐ is straight. Ensure that the hanging bolt nuts are tightened to fix the hanging bolts.
- ▶ To ensure that drain is discharging properly, be sure to hang the unit is straight using a level.

[Fig. 5-3] (P.2)

- Ⓐ Indoor unit's bottom surface

⚠ Caution:

Be sure to install the unit level.

6. Refrigerant piping work

6.1. Refrigerant pipe

[Fig. 6-1] (P.3)

- Ⓐ Indoor unit
- Ⓑ Outdoor unit

Refer to the outdoor unit Instruction Manual for restrictions on the height difference between units and for the amount of additional refrigerant charge.

Avoid the following places for installation where the air conditioner malfunction is liable to occur.

- Where there is too much oil in the air such as for machines or cooking.
- Salty environments as seaside areas.
- Hot-spring areas.
- Where sulfide gas exists.
- Other special atmospheric areas.
- This unit has flared connections on both indoor and outdoor sides. (Fig. 6-1)
- Insulate both refrigerant and drainage piping completely to prevent condensation.

Piping preparation

- Refrigerant pipes 3, 5, 7, 10 and 15 m [5 ft] are available as optional items.

(1) The specifications of commercially available pipes.

Model	Pipe	Outside diameter		Min wall thickness	Insulation thickness	Insulation material
		mm	inch			
SEZ-KD09NA4	For liquid	6.35	1/4	0.8 mm [1/16 in]	8 mm [11/32 in]	Heat-resistant foam plastic, 0.045 specific gravity
	For gas	9.52	3/8	0.8 mm [1/16 in]	8 mm [11/32 in]	
SEZ-KD12NA4	For liquid	6.35	1/4	0.8 mm [1/16 in]	8 mm [11/32 in]	
	For gas	9.52	3/8	0.8 mm [1/16 in]	8 mm [11/32 in]	
SEZ-KD15NA4	For liquid	6.35	1/4	0.8 mm [1/16 in]	8 mm [11/32 in]	
	For gas	12.7	1/2	0.8 mm [1/16 in]	8 mm [11/32 in]	
SEZ-KD18NA4	For liquid	6.35	1/4	0.8 mm [1/16 in]	8 mm [11/32 in]	
	For gas	12.7	5/8	1.0 mm [1/16 in]	8 mm [11/32 in]	

(2) Ensure that the two refrigerant pipes are well insulated to prevent condensation.

(3) Refrigerant pipe bending radius must be 10 cm [3-15/16 in] or more.

⚠ Caution:

Use insulation of specified thickness. Excessive thickness prevents storage behind the indoor unit and smaller thickness causes condensation.

6.2. Flaring work

- Main cause of gas leakage is defect in flaring work. Carry out correct flaring work in the following procedure.

6.2.1. Cutting the pipes

[Fig. 6-3] (P.3)

- Ⓐ Copper tubes
- Ⓑ Good example
- Ⓒ Bad examples
- Ⓓ Tilted
- Ⓔ Uneven
- Ⓕ Burred

- Use a pipe cutter cut the copper tube correctly.

6.2.2. Burr removal

[Fig. 6-4] (P.3)

- Ⓐ Burr
- Ⓑ Copper tube/pipe
- Ⓒ Spare reamer
- Ⓓ Pipe cutter

- Completely remove all burrs from the cut section of pipe/tube.
- Point the end of the copper tube/pipe to downward direction as you remove burrs in order to avoid burrs drop in the tubing.

6.2.3. Putting nut on

[Fig. 6-5] (P.3)

- Ⓐ Flare nut
- Ⓑ Copper tube

- Remove flare nuts attached to indoor and outdoor unit, then attach them on pipe/tube after burr removal. (not possible to attach them on after flaring work)

6.2.4. Flaring work

[Fig. 6-6] (P.3)

- Ⓐ Flaring tool
- Ⓑ Die
- Ⓒ Copper tube
- Ⓓ Flare nut
- Ⓔ Yoke

- Carry out flaring work using flaring tool as shown below.

Pipe diameter (mm [in])	Dimension	
	A (mm [in])	B ± 0.4 [-1/32] (mm [in])
	When the tool for R410A is used	
	Clutch type	
6.35 [1/4]	0 to 0.5 [0 to 1/32]	9.1 [3/8]
9.52 [3/8]	0 to 0.5 [0 to 1/32]	13.2 [17/32]
12.7 [1/2]	0 to 0.5 [0 to 1/32]	16.6 [21/32]
15.88 [5/8]	0 to 0.5 [0 to 1/32]	19.7 [25/32]

Firmly hold copper tube in a die in the dimension shown in the table at above.

6.2.5. Check

[Fig. 6-7] (P.3)

- Ⓐ Smooth
- Ⓑ Inside is shiny without any scratches
- Ⓒ Even length
- Ⓓ Too much
- Ⓔ Tilted
- Ⓕ Scratch on flared plane
- Ⓖ Cracked
- Ⓗ Uneven
- Ⓘ Bad examples

- If flare is defective, cut off the flared section and repeat.

6.3. Pipe connection

[Fig. 6-8] (P.3)

- Apply a thin coat of refrigeration oil on the surface of pipe.
- When connecting, first align the center, then tighten the flare nut 3 to 4 turns.
- Use tightening torque table below as a guideline for indoor unit side union joint section, and tighten using two wrenches. Excessive tightening damages the flare section.

Copper pipe O.D. (mm [in])	Flare nut O.D. (mm [in])	Tightening torque (N·m)
ø6.35 [1/4]	17 [11/16]	14 - 18
ø9.52 [3/8]	22 [7/8]	34 - 42
ø12.7 [1/2]	26 [1-1/32]	49 - 61
ø15.88 [5/8]	29 [1-5/32]	68 - 82

⚠ Warning:

Be careful of removing the flare nut! (Internally pressurize can cause them to burst off.)

Remove the flare nut as follows:

1. Loosen the nut until you hear a hissing noise.
2. Do not remove the nut until the gas has been completely released (i.e., hissing noise stops).
3. Check that the gas has been completely released, and then remove the nut.

Outdoor unit connection

Connect pipes to stop valve pipe joint of the outdoor unit following the same procedure as the indoor unit.

- For tightening, use a torque wrench or spanner, and use the same tightening torque procedure for indoor unit.

6. Refrigerant piping work

Refrigerant pipe insulation

- After connecting refrigerant piping, insulate the joints (flared joints) with thermal insulation tubing.

[Fig. 6-9] (P.3)

Ⓐ Pipe cover (120 mm [3/4 in] small diameter) (accessory)

Ⓢ Caution:

Pull out the thermal insulation on the refrigerant piping at the site, insert the flare nut to flare the end, and reinsert the insulation.

Take care to ensure that condensation does not form on exposed copper piping.

Ⓣ Liquid end of refrigerant piping

Ⓤ Gas end of refrigerant piping

Ⓡ Site refrigerant piping

Ⓢ Main body

Ⓣ Pipe cover (120 mm [3/4 in] large diameter) (accessory)

Ⓤ Thermal insulation (field supplied)

① Pull

② Flare nut

③ Return to original position

④ Ensure that there is no gap here

⑤ Plate on main body

⑥ Tie band (accessory)

⑦ Ensure that there is no gap here. Point joint upwards.

- Remove and discard the rubber bung which is inserted in the end of the unit piping.
- Flare the end of the refrigerant piping.
- Remove the thermal insulation on the site refrigerant piping and replace the insulation in its original position.

Cautions On Refrigerant Piping

- Be sure to use non-oxidized brazing for brazing to ensure that foreign matter or moisture do not enter into the pipe.
- Be sure to apply refrigerating machine oil over the flare connection seating surface and tighten the connection using a double spanner.
- Provide a metal brace to support the refrigerant pipe so that no load is imparted to the indoor unit end pipe. This metal brace should be provided 50 cm [19-11/16 in] away from the indoor unit's flare connection.

6.4. Purging procedures leak test

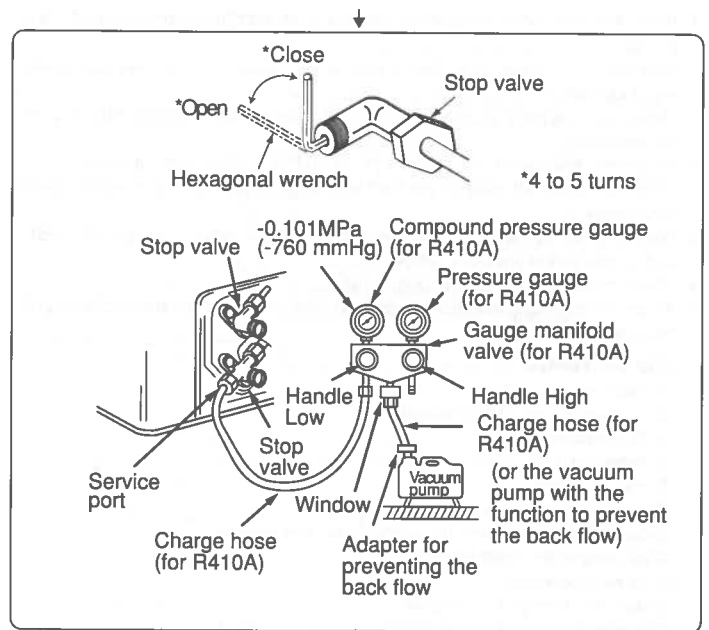
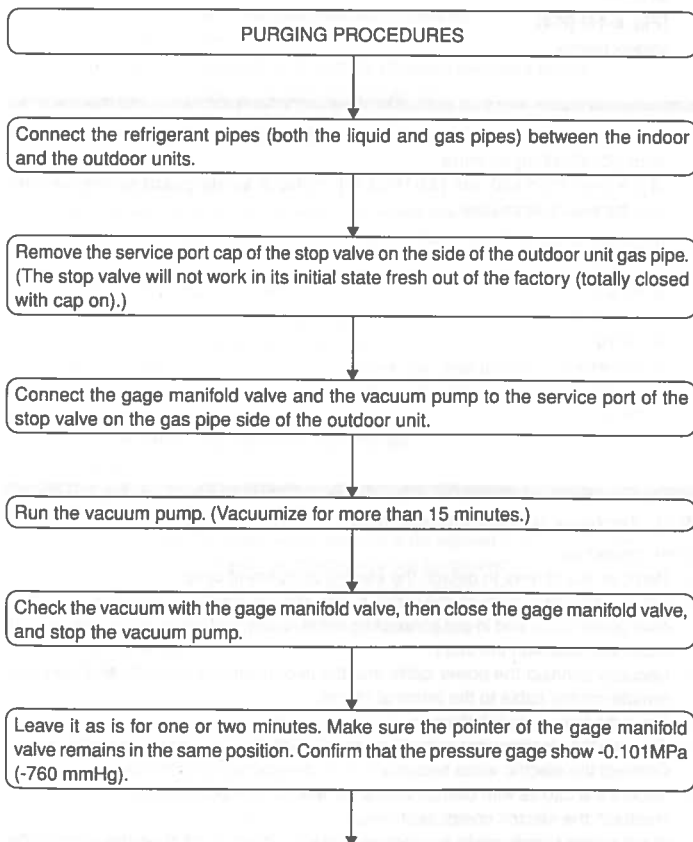

Remove the gage manifold valve quickly from the service port of the stop valve.

After refrigerant pipes are connected and evacuated, fully open all stop valves on gas and liquid pipe sides.
Operating without fully opening lowers the performance and causes trouble.

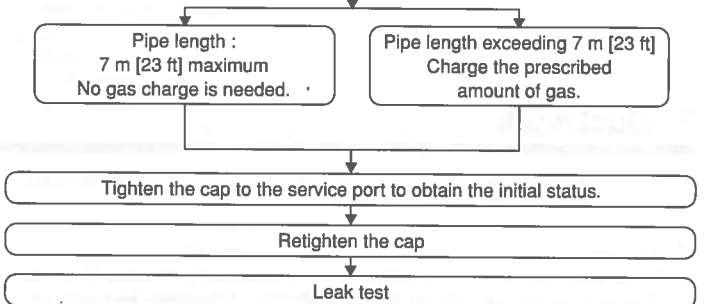

6.5. Drain piping work

- Ensure that the drain piping is downward (pitch of more than 1/100) to the outdoor (discharge) side. Do not add a trap.
- Ensure that any cross drain piping is less than 20 m [65 ft] (excluding the difference of elevation). If the drain piping is long, add metal braces to prevent it from shaking. Never provide an air vent pipe, otherwise drain may be ejected.
- Use a hard vinyl chloride pipe O.D. ϕ 32 mm [1-1/4 in] for drain piping.
- Ensure that collected pipes are 10 cm [3-15/16 in] lower than the unit body's drain port.
- Do not provide any odor trap at the drain discharge port.
- Place the end of the drain piping in a position where odor is not generated.
- Do not put the end of the drain piping in any drain where ionic gases are generated.

[Fig. 6-10] (P.4)

○ Correct piping

× Wrong piping

Ⓐ Insulation (9 mm [3/8 in] or more)

Ⓡ Downward slope (1/100 or more)

Ⓢ Support metal

Ⓣ Air bleeder

Ⓤ Raised

Ⓡ Odor trap

Grouped piping

Ⓣ O. D. ϕ 32 mm [1-1/4 in] PVC TUBE

Ⓢ Make it as large as possible. About 10 cm [3-15/16 in].

Ⓡ Indoor unit

Ⓢ Make the piping size large for grouped piping.

Ⓣ Downward slope (1/100 or more)

Ⓣ O. D. ϕ 38 mm [1-1/2 in] PVC TUBE for grouped piping.
(9 mm [3/8 in] or more insulation)

Ⓡ Up to 550 mm [21-21/32 in]

Ⓡ Drain hose (accessory)

Ⓡ Horizontal or slightly upward

6. Refrigerant piping work

1. Insert the drain hose (accessory) into the drain port (insertion margin: 25 mm [1 in]).
(The drain hose must not be bent more than 45° to prevent the hose from breaking or clogging.)
(Attach the hose with glue for the hard vinyl chloride pipe, and fix it with the band (accessory).)
2. Attach the drain pipe (O.D. ø32 mm [1-1/4 in] PVC TUBE, field supplied).
(Attach the pipe with glue for the hard vinyl chloride pipe, and fix it with the band (accessory).)
3. Perform insulation work on the drain pipe (O.D. ø32 mm [1-1/4 in] PVC TUBE) and on the socket (including elbow).
4. Check the drainage. (Refer to [Fig. 6-13])
5. Attach the insulating material (accessory), and fix it with the band (accessory) to insulate the drain port.

[Fig. 6-11] (P.4)

- Ⓐ Indoor unit
- Ⓑ Pipe cover (60 mm [3/8 in]) (accessory)
- Ⓒ Tie band (accessory)
- Ⓓ Visible part
- Ⓔ Insertion margin
- Ⓕ Drain hose (accessory)
- Ⓖ Drain pipe (O.D. ø32 mm [1-1/4 in] PVC TUBE, field supplied)
- Ⓗ Insulating material (field supplied)
- Ⓘ Tie band (accessory)
- Ⓚ Max. 180 ± 5 mm [7-3/32 ± 7/32 in]
- Ⓛ No gap. The joint of the insulation material must meet at the top.

[Drainage by gravity]

1. Insert the drain hose (accessory) into the drain port.
(The drain hose must not be bent more than 45° to prevent the hose from breaking or clogging.)
The connecting part between the indoor unit and the drain hose may be disconnected at the maintenance. Fix the part with the accessory band, not be adhered.
2. Attach the drain pipe (O.D. ø32 PVC TUBE, field supplied).
(Attach the pipe with glue for the hard vinyl chloride pipe, and fix it with the band (accessory).)
3. Perform insulation work on the drain pipe (O.D. ø32 PVC TUBE) and on the socket (including elbow).

[Fig. 6-12] (P.4) * Drainage by gravity

- Ⓐ Indoor unit
- Ⓑ Pipe cover (30 mm [3/16 in]) (accessory)
- Ⓒ Tie band (accessory)
- Ⓓ Band fixing part
- Ⓔ Insertion margin
- Ⓕ Drain hose (accessory)
- Ⓖ Drain pipe (O.D. ø32 PVC TUBE, field supplied)
- Ⓗ Insulating material (field supplied)
- Ⓚ Max. 145 ± 5 mm

6.6. Confirming drain discharge

- ▶ **Make sure that the drain-up mechanism operates normally for discharge and that there is no water leakage from the connections.**

- Be sure to confirm the above when in heating operation.
 - Be sure to confirm the above before ceiling work is done in the case of a new construction.
1. Remove the water supply port cover on the same side as the indoor unit piping.
 2. Fill water into the feed water pump using a feed water tank. Be sure to put the end of the pump or tank in a drain pan. (If the insertion is incomplete, water may flow over the machine.)
 3. Perform the test run in cooling mode, or turn on the switch SWE on the controller circuit board. (The drain pump and the fan are forced to operate without any remote controller operation.) Make sure using a transparent hose that drain is discharged.

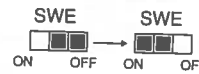

4. After confirmation, cancel the test run mode, and turn off the main power. When the switch SWE has been turned on, turn it off, and attach the water supply port cover into its original position.

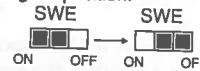

[Fig. 6-13] (P.4)

- Ⓐ Insert pump's end 2 to 4 cm [13/16 to 1-19/32 in].
- Ⓑ Remove the water supply port.
- Ⓒ About 2000 liters
- Ⓓ Water
- Ⓔ Filling port
- Ⓕ Screw

[Fig. 6-14] (P.4)

<Indoor board>

7. Duct work

- When connecting ducts, insert a canvas duct between the main body and the duct.
- Use non-combustible duct components.

⚠ Caution:

- The sound from the intake will increase dramatically if intake Ⓐ is fitted directly beneath the main body. Intake Ⓐ should therefore be installed as far away from the main body as possible.
Particular care is required when using it with bottom inlet specifications.
- Install sufficient thermal insulation to prevent condensation forming on outlet duct flanges and outlet ducts.
- To connect the air conditioner main body and the duct for potential equalization.

8. Electrical work

8.1. Power supply

Electrical specification	Input capacity Main Switch/Fuse (A)			
	SEZ-KD09NA4	SEZ-KD12NA4	SEZ-KD15NA4	SEZ-KD18NA4
Power supply (1 phase ~/N, 208/230V, 60Hz)	10	10	20	20

⚠ Warning:

- The compressor will not operate unless the power supply phase connection is correct.
- Ground protection with a no-fuse breaker (ground leakage breaker) is usually installed for Ⓓ.
- The connection wiring between the outdoor and indoor units can be extended up to a maximum of 50 m [164 ft], and the total extension including the crossover wiring between rooms is a maximum of 80 m [262 ft].

Provide switch with at least 3 mm [1/8 in] contact separation in each pole.

- Label each breaker according to purpose (heater, unit etc.).

[Fig. 8-1] (P.5)

- Ⓐ Indoor unit
- Ⓑ Outdoor unit
- Ⓒ Wired remote controller
- Ⓓ Main switch/fuse
- Ⓔ Ground wire
- Ⓕ Indoor controller board
- Ⓖ Radio frequency interface for RF thermostat

8.2. Indoor wire connection

Work procedure

1. Remove two screws to detach the electric component cover.
 2. Route each cable through the wiring intake into the electric component box. (Procure power cable and in-out connecting cable locally and use wired remote control cable supplied with the unit.)
 3. Securely connect the power cable and the in-out connecting cable and the wired remote control cable to the terminal blocks.
 4. For radio frequency interface
Connect the electric wires securely to the CN105 (RED) of indoor controller board. Connect the electric wires securely to the corresponding terminals.
 5. Secure the cables with clamps inside the electric component box.
 6. Reattach the electric component cover.
- Attach power supply cable and indoor/outdoor cable to control box by using buffer bushing for tensile force. (PG connection or the like.)

⚠ Warning:

- Attach the electrical part cover securely. If it is attached incorrectly, it could result in a fire or electric shock due to dust, water, etc.
- Use the specified indoor/outdoor unit connecting wire to connect the indoor and outdoor units. Attach the wire to the terminal block securely so that stress is not applied to the terminal block connection. Incomplete connection or fixing of the wire could result in a fire.

8. Electrical work

[Fig. 8-2-1] (P.5)

- Ⓐ Screw holding cover (2pcs)
- Ⓑ Cover

[Fig. 8-2-2] (P.5)

- Ⓐ Terminal block box
- Ⓑ Knockout hole
- Ⓒ Remove

[Fig. 8-2-3] (P.5)

- Ⓐ Use conduit to keep the weight of the cable and external force from being applied to the power supply terminal connector.
- Ⓑ Indoor/outdoor unit connecting cable
- Ⓒ Conduit
- Ⓓ Terminal block box
- Ⓔ Knockout hole (for indoor/outdoor unit connecting cable)
- Ⓕ Washer (accessory)
- Ⓖ Tensile force
- Ⓗ Use ordinary bushing
- ① Wired remote controller cable or wiring for radio interface

[Fig. 8-2-4] (P.5)

- Ⓐ Terminal block for indoor/outdoor unit connecting
- Ⓑ Terminal block for wired remote controller
- Ⓒ Indoor/outdoor unit connecting cable
- Ⓓ Wired remote controller cable
- Ⓔ Indoor controller board
- Ⓕ CN105 (RED/5P)
- Ⓖ Wiring for radio interface

[Fig. 8-3] (P.6)

- Ⓐ Indoor terminal block
 - Ⓑ Ground wire (green/yellow)
 - Ⓒ Indoor/outdoor unit connecting cable 3-core 1.5 mm² [AWG 16] or more
 - Ⓓ Outdoor terminal block
 - ① Indoor/outdoor unit connecting cable 3-core 1.5 mm² [AWG 16] or more, following Design 245 IEC 57.
 - ② Indoor terminal block
 - ③ Outdoor terminal block
 - ④ Always install an ground wire (1-core 1.5 mm² [AWG 16]) longer than other cables
 - ⑤ Wired remote controller cable
Wire No × size (mm²): Cable 2C × 0.3
Accessory wire of remote controller
(wire length: 10 m [32 ft], non-polar. Max. 500 m [1640 ft])
 - ⑥ Wired remote controller
- Perform wiring as shown in [Fig. 8-3] (P.6). (Procure the cable locally.)
Make sure to use cables of the correct polarity only.
 - Connect the terminal blocks as shown in [Fig. 8-3] (P.6).

⚠ Caution:

- Conduct electrical work properly.
- Firmly tighten the terminal screws to prevent them from loosening.
- After tightening, pull the wires lightly to confirm that they do not move.

8.3. Remote controller

8.3.1. For wired remote controller

1) Two wired remote controllers setting

If two wired remote controllers are connected, set one to "Main" and the other to "Sub". For setting procedures, refer to "Function selection of remote controller" in the operation manual for the indoor unit.

8.3.2. For IR wireless remote controller

1) Installation area

- Area in which the IR wireless remote controller is not exposed to direct sunshine.
- Area in which there is no near by heating source.
- Area in which the IR wireless remote controller is not exposed to cold (or hot) winds.
- Area in which the IR wireless remote controller can be operated easily.
- Area in which the IR wireless remote controller is beyond the reach of children.
- * The signal can travel up to approximately 7 meters [23 ft] (in a straight line) within 45 degrees to both right and left of the center line of the receiver.

2) Setting the Model No.

[Fig. 8-4] (P.6)

- ① Insert batteries.
- ② Press the SET button with something sharp at the end.
Start this operation from the status of IR wireless remote controller display turned off.
MODEL SELECT blinks and Model No. is lighted.
- ③ Press the temp (M) (A) button to set the Model No.
- ④ Press the SET button with something sharp at the end.
MODEL SELECT and Model No. are lighted for three seconds, then turned off.

Indoor Unit Model	Ⓐ Model No.
SEZ	026

8.4. Function settings

Refer to the manual that came with the remote controller for setting procedure and operation method.

8.4.1 Function setting on the unit (Selecting the unit functions)

1) Changing the external static pressure setting [Fig. 8-5] (P.6)

- Be sure to change the external static pressure setting depending on the duct and the grill used.

- ① Go to the function setting mode.
Switch OFF the remote controller.
Press the (A) and (B) buttons simultaneously and hold them for at least 2 seconds. FUNCTION will start to flash.
- ② Use the (C) button to set the refrigerant address (III) to 00.
- ③ Press (D) and [-] will start to flash in the unit number (IV) display.
- ④ Use the (C) button to set the unit number (IV) to 01-04 or AL.
- ⑤ Press the (E) MODE button to designate the refrigerant address/unit number. [-] will flash in the mode number (I) display momentarily.
- ⑥ Press the (F) buttons to set the mode number (I) to 08.
- ⑦ Press the (G) button and the current set setting number (II) will flash.
Use the (F) button to switch the setting number in response to the external static pressure to be used.

External static pressure	Setting no. of mode no. 08	Setting no. of mode no. 10
5 Pa (0.02 in.WG)	1	2
15 Pa (0.06 in.WG) (before shipment)	1	1
35 Pa (0.14 in.WG)	2	1
50 Pa (0.20 in.WG)	3	1

- ⑧ Press the MODE button (E) and mode and the setting number (I) and (II) will change to being on constantly and the contents of the setting can be confirmed.
- ⑨ Press the FILTER (A) and TEST RUN (B) buttons simultaneously for at least two seconds. The function selection screen will disappear momentarily and the air conditioner OFF display will appear.
- ⑩ To set the static pressure at 5Pa (0.02 in.WG), repeat steps ③ to ⑨. (Set the mode number to 10 for step ⑥.)

2) Other functions

- ① Select unit number 00 for the settings. (Settings for all indoor units)
Refer to Function table 1.
- ② Select unit number 01 to 04 or AL for the settings. (Settings for each indoor unit)
To set the indoor unit in the individual system, select unit number 01.
To set each indoor unit of two, three or four indoor units, which are connected when these units are simultaneously in operation, select unit number 01 to 04.
To set all indoor units of two, three or four indoor units which are connected when these units are simultaneously in operation, select AL.
Refer to Function table 2.

3) For IR wireless remote controller [Fig. 8-6] (P.6)

1. Changing the external static pressure setting.

- Be sure to change the external static pressure setting depending on the duct and the grill used.

- ① Go to the function select mode
Press the CHECK button (F) twice continuously.
(Start this operation from the status of remote controller display turned off.)
CHECK is lighted and "00" blinks.
Press the TEMP button (C) once to set "50". Direct the wireless remote controller toward the receiver of the indoor unit and press the Hour button (A).
- ② Setting the unit number
Press the TEMP button (C) and (D) to set the unit number to 01-04 or 07. Direct the wireless remote controller toward the receiver of the indoor unit and press the Minute button (B).
- ③ Selecting a mode
Enter 08 to change the external static pressure setting using the (C) and (D) buttons.
Direct the wireless remote controller toward the receiver of the indoor unit and press the Hour button (A).
Current setting number: 1 = 1 beep (one second)
2 = 2 beeps (one second each)
3 = 3 beeps (one second each)

- ④ Selecting the setting number
Use the (C) and (D) buttons to change the external static pressure setting to be used.
Direct the wireless remote controller toward the sensor of the indoor unit and press the Hour button (A).
- ⑤ To set the external static pressure
Repeat steps ③ and ④ to set the mode number to 10.
- ⑥ Complete function selection
Direct the wireless remote controller toward the sensor of the indoor unit and press the ON/OFF button (E).

8. Electrical work

Note:

- Whenever changes are made to the function settings after installation or maintenance, be sure to record the changes with a mark in the "Setting" column of the Function table.

Function table 1

Select unit number 00

Mode	Settings	Mode no.	Setting no.	Initial setting	Check
Power failure automatic recovery*1 (AUTO RESTART FUNCTION)	Not available	01	1		
	Available *1		2	○	
Indoor temperature detecting	Indoor unit operating average	02	1	○	
	Set by indoor unit's remote controller		2		
	Remote controller's internal sensor		3		
LOSSNAY connectivity	Not Supported	03	1	○	
	Supported (indoor unit is not equipped with outdoor-air intake)		2		
	Supported (indoor unit is equipped with outdoor-air intake)		3		

Function table 2

Select unit numbers 01 to 04 or all units (AL [wired remote controller]/07 [wireless remote controller])

Mode	Settings	Mode no.	Setting no.	Initial setting	Check
Filter sign	100 Hr	07	1		
	2500 Hr		2		
	No filter sign indicator		3	○	
External static pressure	15 Pa (0.06 in.WG)	08	1	○	
	35 Pa (0.14 in.WG)		2		
	50 Pa (0.20 in.WG)		3		
	The same as setting of mode no.08	10	1	○	
5 Pa (0.02 in.WG) (set mode no. 08 to 1)	2				

*1 When the power supply returns, the air conditioner will start 3 minutes later.

Note: When the function of an indoor unit were changed by function selection after the end of installation, always indicate the contents by entering a ○ or other mark in the appropriate check filed of the tables.

9. Test run

9.1. Before test run

- After completing installation and the wiring and piping of the indoor and outdoor units, check for refrigerant leakage, looseness in the power supply or control wiring, wrong polarity, and no disconnection of one phase in the supply.
- Use a 500-volt megohmmeter to check that the resistance between the power supply terminals and ground is at least 1.0 MΩ.
- Do not carry out this test on the control wiring (low voltage circuit) terminals.

⚠ Warning:

Do not use the air conditioner if the insulation resistance is less than 1.0 MΩ.

Insulation resistance

After installation or after the power source to the unit has been cut for an extended period, the insulation resistance will drop below 1 MΩ due to refrigerant accumulation in the compressor. This is not a malfunction. Perform the following procedures.

- Remove the wires from the compressor and measure the insulation resistance of the compressor.
- If the insulation resistance is below 1 MΩ, the compressor is faulty or the resistance dropped due the accumulation of refrigerant in the compressor.
- After connecting the wires to the compressor, the compressor will start to warm up after power is supplied. After supplying power for the times indicated below, measure the insulation resistance again.

- The insulation resistance drops due to accumulation of refrigerant in the compressor. The resistance will rise above 1 MΩ after the compressor is warmed up for two to three hours.
(The time necessary to warm up the compressor varies according to atmospheric conditions and refrigerant accumulation.)
 - To operate the compressor with refrigerant accumulated in the compressor, the compressor must be warmed up at least 12 hours to prevent breakdown.
4. If the insulation resistance rises above 1 MΩ, the compressor is not faulty.

⚠ Caution:

- The compressor will not operate unless the power supply phase connection is correct.
- Turn on the power at least 12 hours before starting operation.
- Starting operation immediately after turning on the main power switch can result in severe damage to internal parts. Keep the power switch turned on during the operational season.

9.2. Test run

- Refer to the installation manual that comes with each remote controller for details.

9.3. Self-check

- Refer to the installation manual that comes with each remote controller for details.
- RF thermostat is not established.

[Output pattern A] Errors detected by indoor unit

IR wireless remote controller	Wired remote controller RF thermostat	Symptom	Remark
Beeper sounds/OPERATION INDICATOR lamp flashes (Number of times)	Check code		
1	P1	Intake sensor error	
2	P2, P9	Pipe (Liquid or 2-phase pipe) sensor error	
3	E6, E7	Indoor/outdoor unit communication error	
4	P4	Drain sensor error	
5	P5	Drain pump error	
6	P6	Freezing/Overheating safeguard operation	
7	EE	Communication error between indoor and outdoor units	
8	P8	Pipe temperature error	
9	E4	Remote controller signal receiving error	
10	-	-	
11	-	-	
12	Fb	Indoor unit control system error (memory error, etc.)	
No sound	--	No corresponding	

9. Test run

[Output pattern B] Errors detected by unit other than indoor unit (outdoor unit, etc.)

IR wireless remote controller Beeper sounds/OPERATION INDICATOR lamp flashes (Number of times)	Wired remote controller RF thermostat	Symptom	Remark
	Check code		
1	E9	Indoor/outdoor unit communication error (Transmitting error) (Outdoor unit)	For details, check the LED display of the outdoor controller board.
2	UP	Compressor overcurrent interruption	
3	U3, U4	Open/short of outdoor unit thermistors	
4	UF	Compressor overcurrent interruption (When compressor locked)	
5	U2	Abnormal high discharging temperature/49C worked/ insufficient refrigerant	
6	U1, Ud	Abnormal high pressure (63H worked)/ Overheating safeguard operation	
7	U5	Abnormal temperature of heat sink	
8	U8	Outdoor unit fan protection stop	
9	U6	Compressor overcurrent interruption/Abnormal of power module	
10	U7	Abnormality of super heat due to low discharge temperature	
11	U9, UH	Abnormality such as overvoltage or voltage shortage and abnormal synchronous signal to main circuit/Current sensor error	
12	—	—	
13	—	—	
14	Others	Other errors (Refer to the technical manual for the outdoor unit.)	

*1 If the beeper does not sound again after the initial two beeps to confirm the self-check start signal was received and the OPERATION INDICATOR lamp does not come on, there are no error records.

*2 If the beeper sounds three times continuously "beep, beep, beep (0.4 + 0.4 + 0.4 sec.)" after the initial two beeps to confirm the self-check start signal was received, the specified refrigerant address is incorrect.

- On IR wireless remote controller
The continuous buzzer sounds from receiving section of indoor unit.
Blink of operation lamp
- On wired remote controller
Check code displayed on the LCD.

• If the unit cannot be operated properly after the above test run has been performed, refer to the following table to remove the cause.

Symptom		Cause
Wired remote controller	LED 1, 2 (PCB in outdoor unit)	
PLEASE WAIT	For about 2 minutes following power-on	After LED 1, 2 are lighted, LED 2 is turned off, then only LED 1 is lighted. (Correct operation)
PLEASE WAIT → Error code	After about 2 minutes has expired following power-on	Only LED 1 is lighted. → LED 1, 2 blink.
Display messages do not appear even when operation switch is turned ON (operation lamp does not light up).		Only LED 1 is lighted. → LED 1, 2 blinks twice, LED 2 blinks once.

On the IR wireless remote controller with conditions above, following phenomena takes place.

- No signals from the remote controller are accepted.
- OPE lamp is blinking.
- The buzzer makes a short ping sound.

Note:

Operation is not possible for about 30 seconds after cancellation of function selection. (Correct operation)

For description of each LED (LED1, 2, 3) provided on the indoor controller, refer to the following table.

LED 1 (power for microcomputer)	Indicates whether control power is supplied. Make sure that this LED is always lit.
LED 2 (power for remote controller)	Indicates whether power is supplied to the remote controller. This LED lights only in the case of the indoor unit which is connected to the outdoor unit refrigerant address "0".
LED 3 (communication between indoor and outdoor units)	Indicates state of communication between the indoor and outdoor units. Make sure that this LED is always blinking.

9.4. AUTO RESTART FUNCTION

Indoor controller board

This model is equipped with the AUTO RESTART FUNCTION.

When the indoor unit is controlled with the remote controller, the operation mode, set temperature, and the fan speed are memorized by the indoor controller board. The auto restart function sets to work the moment the power has restored after power failure, then, the unit will restart automatically.

Set the AUTO RESTART FUNCTION using the remote controller. (Mode no.01)

10. Easy maintenance function (For wired remote controller only)

Display example (Comp discharge temperature 147°F)

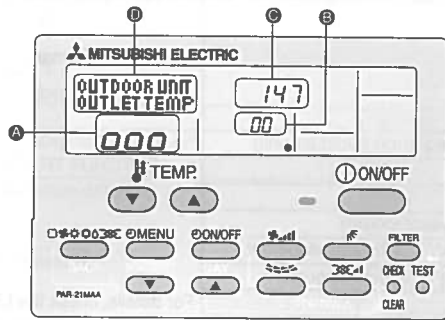

By using the maintenance mode, you can display many types of maintenance data on the wired remote controller such as the heat exchanger temperature and compressor current consumption for the indoor and outdoor units. This function can be used whether the air conditioner is operating or not. During air conditioner operation, data can be checked during either normal operation or maintenance mode stable operation.

* This function cannot be used during the test run.

* The availability of this function depends on the connecting outdoor unit. Refer to the brochures.

Maintenance mode operation procedures

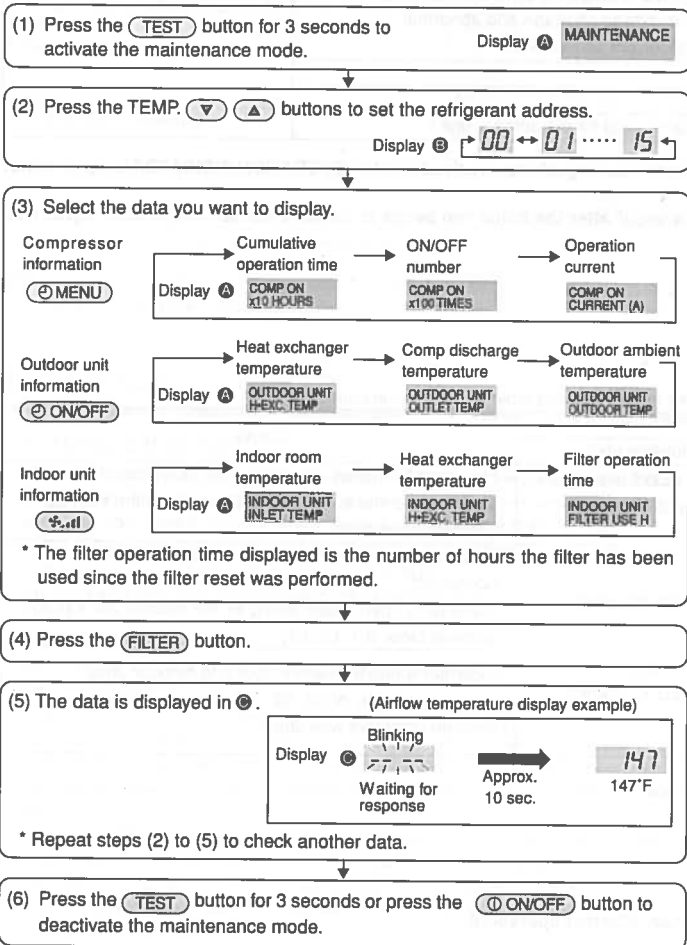

Stable operation

Using the maintenance mode, the operation frequency can be fixed and the operation can be stabilized. If the air conditioner is stopped, use the following procedure to start this operation.

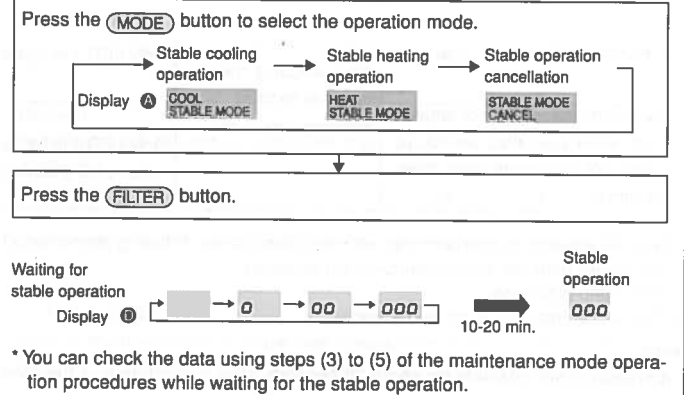

11. Maintenance

11.1. Gas charge

[Fig. 11-1] (P.7)

- Ⓐ Indoor unit
- Ⓑ Union
- Ⓒ Liquid pipe
- Ⓓ Gas pipe
- Ⓔ Stop valve
- Ⓕ Outdoor unit
- Ⓖ Refrigerant gas cylinder operating valve
- Ⓗ Refrigerant gas cylinder for R410A with siphon
- Ⓘ Refrigerant (liquid)
- Ⓢ Electronic scale for refrigerant charging
- Ⓚ Charge hose (for R410A)
- Ⓛ Gauge manifold valve (for R410A)
- Ⓜ Service port

1. Connect gas cylinder to the service port of stop valve (3-way).
2. Execute air purge of the pipe (or hose) coming from refrigerant gas cylinder.
3. Replenish specified amount of refrigerant, while running the air conditioner for cooling.

Note:

In case of adding refrigerant, comply with the quantity specified for the refrigerating cycle.

⚠ Caution:

- Do not discharge the refrigerant into the atmosphere. Take care not to discharge refrigerant into the atmosphere during installation, or repairs to the refrigerant circuit.
- For additional charging, charge the refrigerant from liquid phase of the gas cylinder. If the refrigerant is charged from the gas phase, composition change may occur in the refrigerant inside the cylinder and the outdoor unit. In this case, ability of the refrigerating cycle decreases or normal operation can be impossible. However, charging the liquid refrigerant all at once may cause the compressor to be locked. Thus, charge the refrigerant slowly.

To maintain the high pressure of the gas cylinder, warm the gas cylinder with warm water (under 104 °F [40 °C]) during cold season. But never use naked fire or steam.

Index

1. Consignes de sécurité	17
2. Choisir l'emplacement de l'installation	17
3. Sélection de l'emplacement d'installation et accessoires	18
4. Fixation des boulons de suspension	18
5. Installation de l'appareil	19
6. Mise en place des tuyaux de réfrigérant	19
7. Travaux de conduites	21
8. Installations électriques	22

9. Marche d'essai	24
10. Fonction d'entretien aisé	26
11. Entretien	26

Le manuel d'installation ne concerne que l'unité intérieure et l'unité extérieure de la série SUZ.
Si l'appareil extérieur fait partie de la série MXZ, consulter le manuel d'installation de cette série MXZ.

1. Consignes de sécurité

- Avant la connexion au système, le signaler au distributeur d'électricité ou demander son accord.
- Veuillez lire en entier "Les mesures de sécurité suivantes doivent toujours être respectées" avant d'installer le climatiseur.
- Comme ces mesures sont très importantes pour votre sécurité, veuillez les respecter.

• Les symboles signifient.

⚠ **Avertissement:**

pourrait résulter en un décès, une blessure grave, etc.

⚠ **Attention:**

pourrait résulter en une blessure grave, selon les circonstances, si l'appareil est incorrectement utilisé.

- Lorsque vous aurez lu le manuel en entier, veuillez le garder dans un endroit pratique, chez le client, avec le manuel d'utilisation.

⚠ **Avertissement:**

Utilisez uniquement un réfrigérant de type indiqué dans les manuels fournis avec l'unité et sur la plaque signalétique.

- Faute de quoi, l'unité ou la tuyauterie pourrait éclater, ou cela pourrait provoquer une explosion ou un incendie pendant l'utilisation, la réparation ou la mise au rebut de l'unité.

- Cela pourrait également constituer une violation des lois applicables.

- MITSUBISHI ELECTRIC CORPORATION ne peut être tenue responsable de tout dysfonctionnement ou accident résultant de l'utilisation du mauvais type de réfrigérant.

• Toujours revêtir des vêtements de protection pour manipuler ce produit.

Par ex.: gants, protection intégrale des bras par combinaison et lunettes de sécurité.

- Vous risqueriez de vous blesser.

• Ne pas installer l'appareil vous-même (client).

Toute mauvaise installation pourrait résulter en une blessure due à un incendie, un choc électrique, ou une fuite d'eau ou si l'appareil tombait. Consulter votre distributeur ou technicien spécialisé.

• Vous assurer que l'appareil est installé dans un endroit assez solide pour en supporter le poids.

Autrement, il pourrait tomber et par conséquent blesser quelqu'un.

• Utiliser les câbles spécifiés pour connecter les appareils intérieur et extérieur en toute sécurité, et attacher les fils fermement au bloc de sorties pour qu'aucune force venant des fils ne soit exercée sur les bornes.

Toute connexion ou attachement défectueux pourrait résulter en un incendie.

⚠ **Attention:**

• Mettre l'appareil à la terre.

Ne pas relier le câble de terre au tuyau de gaz, d'eau, un parafoudre ou un câble de terre téléphonique. Toute mise à la terre défectueuse pourrait être la cause d'un choc électrique.

• Ne pas installer l'appareil dans un endroit où il sera exposé à des gaz inflammables.

Tout gaz accumulé autour de l'appareil pourrait exploser.

• Installer un disjoncteur différentiel si nécessaire (lorsque l'endroit de l'installation est humide.)

Sans disjoncteur différentiel, il y aura risque de décharge électrique.

2. Choisir l'emplacement de l'installation

2.1. Appareil intérieur

- Emplacement ne favorisant pas la circulation d'air.
- Emplacement favorisant une bonne répartition de l'air froid dans la pièce.
- Emplacement ne favorisant pas une exposition directe au soleil.
- À une distance au moins égale à 1 m [39-3/8 in] d'un téléviseur ou d'une radio (pour éviter que l'image ne soit déformée ou que des sons ne soient produits).

2.2. Appareil extérieur

- Emplacement ne favorisant pas une exposition aux rafales de vent.
- Emplacement favorisant une bonne circulation d'air sans poussière.
- Emplacement ne favorisant pas une exposition directe à la pluie et au soleil.
- Emplacement ne suscitant pas une nuisance par le bruit de fonctionnement de l'appareil et la pulsion d'air chaud pour le voisinage.

Symboles sur l'appareil

⊘ : Indique une action qui doit être évitée.

⚠ : Indique que des instructions importantes doivent être prises en considération.

⚡ : Indique un élément qui doit être mis à la terre.

⚠ : Indique des précautions à prendre lors du maniement de pièces tournantes.

⚠ : Indique que l'interrupteur principal doit être désactivé avant d'effectuer tout travail d'entretien.

⚠ : Danger d'électrocution.

⚠ : Attention, surface chaude.

⚠ **Avertissement:**

Prendre soin de lire les étiquettes se trouvant sur l'appareil principal.

• N'utilisez pas de rallonge et ne branchez pas plusieurs appareils à la même prise de courant CA.

Il y aurait risque d'incendie ou de décharge électrique à cause d'un contact ou d'une isolation défectueuse, ou à cause d'un excès de courant etc.

• Vérifier que le gaz réfrigérant ne fuit pas lorsque l'installation est terminée.

• Veuillez suivre ce manuel durant l'installation.

Toute installation défectueuse pourrait être la cause d'une blessure due à un incendie, une décharge électrique, si l'appareil tombait ou une fuite d'eau.

• Veuillez suivre ce manuel durant l'installation électrique et veuillez utiliser un circuit exclusif pour cette installation électrique.

Tout manque de capacité de circuit ou toute installation défectueuse pourrait résulter en un incendie ou une décharge électrique.

• Veuillez fermement attacher les couvercles de la partie électrique de l'appareil intérieur et le panneau de service de l'appareil extérieur.

Tout attachement défectueux du couvercle de l'appareil intérieur et/ou le panneau de service de l'appareil extérieur pourrait résulter en un incendie ou un choc électrique à cause de la poussière, de l'eau, etc, pouvant s'infiltrer.

• Veuillez vous assurer d'utiliser la pièce fournie ou les pièces spécifiées pour l'installation.

Toute pièce défectueuse utilisée pourrait être la cause d'un incendie, d'un choc électrique, de l'appareil tombant de sa position, etc, ce qui résulterait en une blessure ou une fuite d'eau.

• Aérez le local en cas de fuite de liquide frigorigène en cours de fonctionnement. Tout contact du liquide frigorigène avec une flamme libère des gaz toxiques.

• Veuillez suivre les instructions de ce manuel pour l'installation de la tuyauterie et du système d'évacuation.

Si cette installation n'est pas faite correctement, il est possible que l'appareil fuie et par conséquent mouille ou abime vos meubles.

• Serrer l'écrou évasé avec une clé dynamométrique en respectant les indications du présent manuel.

Un écrou évasé trop serré peut en effet casser après un certain temps et provoquer une fuite de réfrigérant.

⚠ **Avertissement:**

Fixer l'appareil intérieur dans un plafond suffisamment résistant pour supporter son poids.

• Emplacement avec un mur solide ou un support ferme empêchant la propagation du bruit de fonctionnement et de vibrations.

• Emplacement où il n'y a aucun risque de fuites de gaz combustibles.

• Lorsque l'appareil est installé en hauteur, les pieds de support doivent être installés.

• A 3 m [10 ft] au moins de l'antenne d'un téléviseur ou d'une radio. (Autrement il pourrait y avoir du brouillage sonore ou visuel.)

• Installer l'appareil à l'horizontale.