

Changes for the Better

CITY MULTI Control System
and Mitsubishi Mr. Slim Air Conditioners

MA Remote Controller PAR-31MAA

TECHNICAL MANUAL



Mr. SLIM

Product Features

Safety precautions

Names and functions of controller components

Read before operating the controller

Controller operation : Basic operations

Controller operation : Function settings

Maintenance

Initial setting

Service

Installation

System control (for Mr.Slim)

Specifications · Outline Demensions

Contents

Product features	6
Safety precautions	8
Names and functions of controller components	9
Controller interface	9
Display.....	10
Read before operating the controller	11
Menu structure	11
Main menu list	12
Remote controller function	13
Icon explanations	14
Restrictions for the sub remote controller.....	14
Controller operation : Basic operations	15
Power ON / OFF.....	15
Operation mode, temperature, and fan speed settings	16
Navigating through the Main menu	19
Vane · Louver · Vent. (Lossnay)	21
High power Mr.Slim only	23
Timer	24
On / Off timer.....	24
Auto-Off timer.....	26
Filter information.....	28
Error information.....	30
Controller operation : Function settings	32
Weekly timer.....	32
Energy saving.....	34
Automatic return to the preset temperature.....	34
Setting the energy-saving operation schedule Mr.Slim only	36
OU silent mode.....	38
Night setback.....	40
Restriction	42
Setting the temperature range restriction	42
Operation lock function.....	44
Maintenance	45
Auto descending panel.....	45
Manual vane angle	46
Initial setting	48
Main / Sub	48
Clock	49
Main display	50
Contrast.....	51
Display detail setting	52
Clock	52
Temperature Unit, Room temp, Auto mode	53
Auto mode setting	54
Administrator password setting	55
Language selection	56

Service.....	57
Service menu	57
Test run	58
Drain pump test run.....	59
Input maintenance info.....	60
Model name input.....	60
Serial No. input.....	61
Dealer information input	62
Initialize maintenance info.....	62
Function setting Mr.Slim only	64
Other function selections.....	66
Function setting City Multi only	68
LOSSNAY setting City Multi only	70
Check	72
Error history.....	72
Refrigerant leak check Mr.Slim only	73
Smooth maintenance Mr.Slim only	74
Request code Mr.Slim only	75
Self check.....	77
Maintenance password	78
Remote controller check.....	79
Installation.....	80
System control (for Mr.Slim)	87
Specifications · Outline demensions.....	96
Specifications	96
Outline demensions.....	98
List of functions which can / cannot be used in combination.....	99

<p>"OU Silent mode" and "Refrigerant volume check" that appear on the display of the remote control do not function.</p>
--

Product features

Ideal remote controller in pursuit of easy operation, convenience, and energy saving.

Feature 1

Feature 2

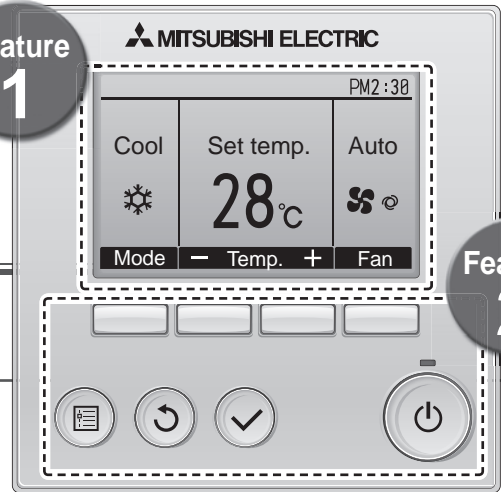

EASY OPERATION

Backlit LCD (Liquid Crystal Display)

Full dot backlit LCD makes it easy to see and control units.

Feature 1

Large, easy-to-see display

Full-dot LCD display with large characters for easy viewing. Contrast also adjustable.

Feature 2

Simple button arrangement

Buttons are arranged according to usage to allow for intuitive navigation. Frequently used buttons are larger than other buttons to prevent unintended.

CONVENIENCE

Night Setback

To prevent indoor dew or excessive temperature rise, this control starts heating operation when the control object group is stopped and the room temperature drops below the preset lower limit temperature. Also, this control starts cooling operation when the control object group is stopped and the room temperature rises above the preset upper limit temperature.

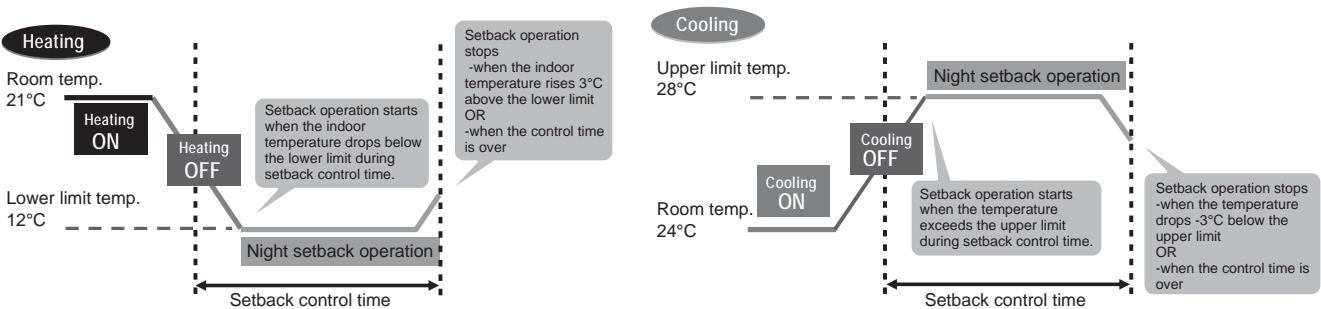

ENERGY SAVING

Auto Return

This function helps to maintain the indoor temperature at the required level. Even if the temperature setting is changed during operation, the set temperature automatically returns to the originally preset temperature after certain amount of time. It is possible to set the required temperature for limited time (30-120 min. in 10-minute increments).

<Sample screens when the Auto return function is enabled>

Example: Lower the Set temp. to 24°C. 60 minutes later, the Set temp. will be back to 28°C.

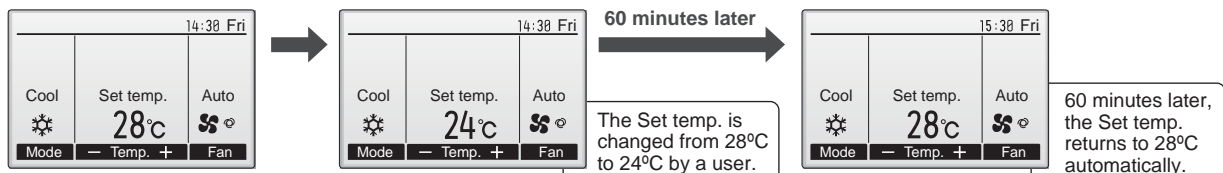

Functions

Basic Functions



- ON/OFF ▪ Operation mode switching ▪ Room temperature setting/display ▪ Fan speed setting
- Vane setting ▪ Louver setting ▪ Clock setting/display ▪ Filter information display

Advanced Functions

Display mode switching	The main display can be displayed in two different modes: "Full" and "Basic".
Error information	Error code, error unit, unit address, unit model, serial number, contact information (dealer's phone number) can be displayed. * The unit model, serial number, and contact information need to be registered in advance to be displayed. * The unit address may not be displayed depending on the error type.
Ventilation equipment control	Interlock settings and interlock operation settings for Lossnay units can be made. OFF/High/Low can be switched.
High power Mr.Slim only	The units operate at higher-than-normal capacity for up to 30 minutes.
Auto descending panel	The automatic descending panel can be operated. * Valid only for the indoor units that are compatible with this function.
Timer	On/Off timer: The unit automatically turns on or off at the preset time. • Time can be set in 5-minute increments. • It is possible to set only the time when the unit turns on or when the unit turns off. Auto-Off timer: The unit automatically stops after the preset time has elapsed. • Time can be set to a value from 30 to 240 in 10-minute increments.
Weekly timer	ON/OFF and temperature setting can be scheduled for each day. • Up to eight operation patterns can be set for each day. • Time can be set in 5-minute increments. * Not valid when the On/Off timer is enabled.
Energy saving Mr.Slim only	The start/stop times to operate the units in the energy-save mode for each day of the week, and the energy-saving rate can be set. • Up to four energy-save operation patterns can be set for each day. • Time can be set in 5-minute increments. • Energy-saving rate can be set to a value from 0% and 50 to 90% in 10% increments.
Operation lock	Settings including ON/OFF, Operation mode, Set temp. and Vane can be locked.
Temperature range restriction	The lower limit and the upper limit of the settable temperature in each operation mode can be limited.
Password	Administrator password (required for schedule setting) and Maintenance password (required for test run and function setting) can be set.
Language selection	Language to be displayed on the screen can be selected from eight languages: English, French, German, Spanish, Italian, Portuguese, Swedish, and Russian.
Contrast	Screen contrast can be adjusted.
Manual vane angle	The vane angle can be set to a fixed position. * Valid only for the indoor units that are compatible with this function.

Safety precautions

- Thoroughly read the following safety precautions before using the unit.
- Observe these precautions carefully to ensure safety.

 WARNING	Indicates a risk of death or serious injury.
 CAUTION	Indicates a risk of serious injury or structural damage.

- After reading this manual, pass it on to the end user to retain for future reference.
- Keep this manual for future reference and refer to it as necessary. This manual should be made available to those who repair or relocate the controller. Make sure that the manual is passed on to any future users.

General precautions

WARNING

Do not install the unit in a place where large amounts of oil, steam, organic solvents, or corrosive gases, such as sulfuric gas, are present or where acidic/alkaline solutions or sprays are used frequently. These substances can compromise the performance of the unit or cause certain components of the unit to corrode, which can result in electric shock, malfunctions, smoke, or fire.

To reduce the risk of injury or electric shock, before spraying a chemical around the controller, stop the operation and cover the controller.

To reduce the risk of shorting, current leakage, electric shock, malfunctions, smoke, or fire, do not wash the controller with water or any other liquid.

To reduce the risk of injury or electric shock, stop the operation and switch off the power supply before cleaning, maintaining, or inspecting the controller.

To reduce the risk of electric shock, malfunctions, smoke or fire, do not operate the switches/buttons or touch other electrical parts with wet hands.

If any abnormality (e.g., burning smell) is noticed, stop the operation, turn off the power switch, and consult your dealer. Continued use of the product may result in electric shock, malfunctions, or fire.

When disinfecting the unit using alcohol, ventilate the room adequately. The fumes of the alcohol around the unit may cause a fire or explosion when the unit is turned on.

Properly install all required covers to keep moisture and dust out of the controller. Dust accumulation and water can cause electric shock, smoke, or fire.

CAUTION

To reduce the risk of fire or explosion, do not place flammable materials or use flammable sprays around the controller.

To reduce the risk of environmental pollution, consult an authorized agency for proper disposal of remote controller.

To reduce the risk of damage to the controller, do not directly spray insecticide or other flammable sprays on the controller.

To reduce the risk of electric shock or malfunctions, do not touch the touch panel, switches, or buttons with a pointy or sharp object.

To reduce the risk of injury and electric shock, avoid contact with sharp edges of certain parts.

To reduce the risk of injury, wear protective gear when working on the controller.

To avoid injury from broken glass, do not apply excessive force on the glass parts.

Precautions for moving or repairing the controller

WARNING

The controller should be repaired or moved only by qualified personnel. Do not disassemble or modify the controller. Improper installation or repair may cause injury, electric shock, or fire.

CAUTION

To reduce the risk of shorting, electric shock, fire, or malfunction, do not touch the circuit board with tools or with your hands, and do not allow dust to accumulate on the circuit board.

Additional precautions

To avoid damage to the controller, use appropriate tools to install, inspect, or repair the controller.

To avoid discoloration, do not use benzene, thinner, or chemical rag to clean the controller. To clean the controller, wipe with a soft cloth soaked in water with mild detergent, wipe off the detergent with a wet cloth, and wipe off water with a dry cloth.

This controller is designed for exclusive use with the Building Management System by Mitsubishi Electric. The use of this controller for with other systems or for other purposes may cause malfunctions.

To avoid damage to the controller, provide protection against static electricity.

Names and functions of controller components

Controller interface

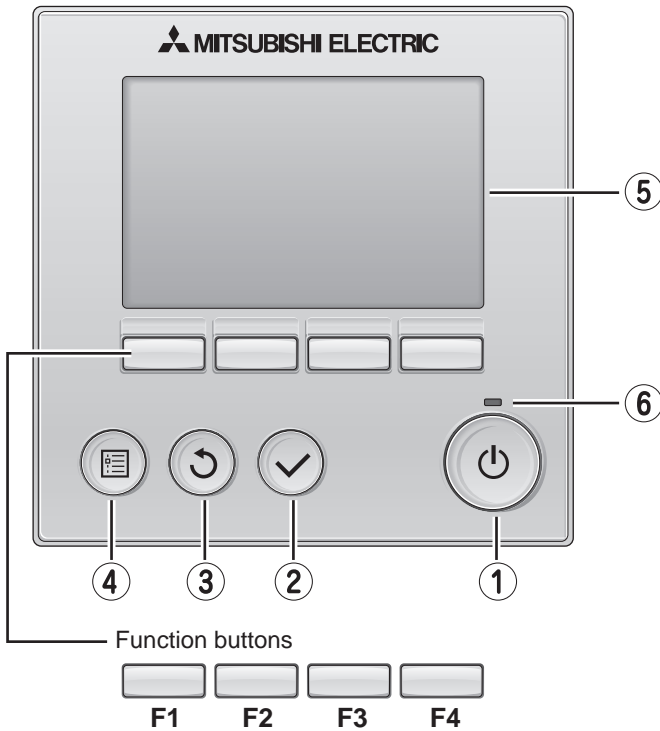

The functions of the function buttons change depending on the screen. Refer to the button function guide that appears at the bottom of the LCD for the functions they serve on a given screen.

When the system is centrally controlled, the button function guide that corresponds to the locked button will not appear.

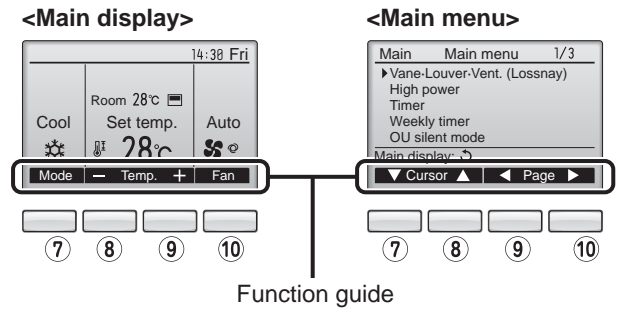

① ON / OFF button

Press to turn ON/OFF the indoor unit.

② SELECT button

Press to save the setting.

③ RETURN button

Press to return to the previous screen.

④ MENU button

Press to bring up the Main menu.

⑤ Backlit LCD

Operation settings will appear.
When the backlight is off, pressing any button turns the backlight on and it will stay lit for a certain period of time depending on the screen.

When the backlight is off, pressing any button turns the backlight on and does not perform its function. (except for the  (ON / OFF) button)

⑥ ON / OFF lamp

This lamp lights up in green while the unit is in operation. It blinks while the remote controller is starting up or when there is an error.

⑦ Function button **F1**

Main display : Press to change the operation mode.
Main menu : Press to move the cursor down.

⑧ Function button **F2**

Main display : Press to decrease temperature.
Main menu : Press to move the cursor up.

⑨ Function button **F3**

Main display : Press to increase temperature.
Main menu : Press to go to the previous page.

⑩ Function button **F4**

Main display : Press to change the fan speed.
Main menu : Press to go to the next page.

Display

The main display can be displayed in two different modes: "Full" and "Basic".
The factory setting is "Full". To switch to the "Basic" mode, change the setting on the Main display setting. (Refer to page 50)

<Full mode>

* All icons are displayed for explanation.

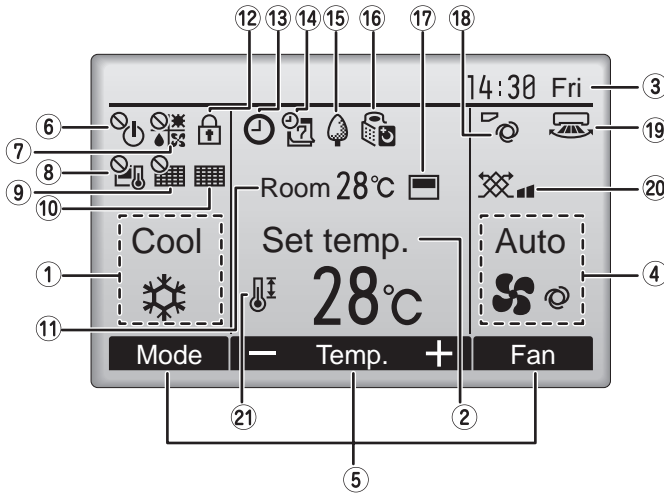

<Basic mode>

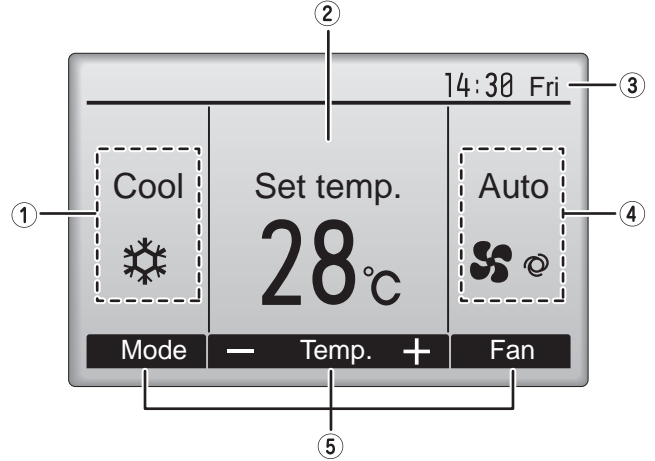

① Operation mode Page 16

Indoor unit operation mode appears here.

② Preset temperature Page 16

Preset temperature appears here.

③ Clock (See the Installation Manual.)

Current time appears here.

④ Fan speed Page 16

Fan speed setting appears here.

⑤ Button function guide

Functions of the corresponding buttons appear here.

⑥

Appears when the ON/OFF operation is centrally controlled.

⑦

Appears when the operation mode is centrally controlled.

⑧

Appears when the preset temperature is centrally controlled.

⑨

Appears when the filter reset function is centrally controlled.

⑩ Page 28

Indicates when filter needs maintenance.

⑪ Room temperature (See the Installation Manual.)

Current room temperature appears here.

⑫ Page 44

Appears when the buttons are locked.

⑬ Page 24, 38, 40

Appears when the On/Off timer or Night setback function is enabled.

⑭ Page 32

Appears when the Weekly timer is enabled.

⑮ Page 34

Appears while the units are operated in the energy-save mode. (Will not appear on some models of indoor units)

⑯ Page 38

Appears while the outdoor units are operated in the silent mode.

⑰

Appears when the built-in thermistor on the remote controller is activated to monitor the room temperature (a).

 appears when the thermistor on the indoor unit is activated to monitor the room temperature.

⑱ Page 20

Indicates the vane setting.

⑲ Page 20

Indicates the louver setting.

⑳ Page 20

Indicates the ventilation setting.

㉑ Page 42

Appears when the preset temperature range is restricted.

Most settings (except ON / OFF, mode, fan speed, temperature) can be made from the Menu screen. (Refer to page 19)

Read before operating the controller

Menu structure

Press the **[MENU]** button.
Move the cursor to the desired item with the **[F1]** and **[F2]** buttons, and press the **[SELECT]** button.

Main menu	
Vane · Louver · Vent. (Lossnay)	Page 21
High power	Page 23
Timer	
On / Off timer	Page 24
Auto-Off timer	Page 26
Weekly timer	Page 32
OU silent mode	Page 38
Restriction	
Temp. range	Page 42
Operation lock	Page 44
Energy saving	
Auto return	Page 34
Schedule	Page 36
Night setback	Page 40
Filter information	Page 28
Error information	Page 30
Maintenance	
Auto descending panel	Page 45
Manual vane angle	Page 46
Initial setting	
Main / Sub	Page 48
Clock	Page 49
Main display	Page 50
Contrast	Page 51
Display details	Page 52
Auto mode	Page 54
Administrator password	Page 55
Language selection	Page 56
Service	
Service menu	Page 57
Test run	Page 58
Drain pump test run	Page 59
Input maintenance info.	Page 60
Function setting (Mr. Slim)	Page 64
Function setting (City Multi)	Page 68
Lossnay (City Multi only)	Page 70
Check	Page 72
Self check	Page 77
Maintenance password	Page 78
Remote controller check	Page 79

Not all functions are available on all models of indoor units.

Main menu list

Setting and display items		Setting details	Reference page
Vane · Louver · Vent. (Lossnay)		<p>Use to set the vane angle.</p> <ul style="list-style-type: none"> • Select a desired vane setting from five different settings. <p>Use to turn ON / OFF the louver.</p> <ul style="list-style-type: none"> • Select a desired setting from "ON" and "OFF." <p>Use to set the amount of ventilation.</p> <ul style="list-style-type: none"> • Select a desired setting from "Off," "Low," and "High." 	21
High power		<p>Use to reach the comfortable room temperature quickly.</p> <ul style="list-style-type: none"> • Units can be operated in the High-power mode for up to 30 minutes. 	23
Timer	On/Off timer	<p>Use to set the operation On/Off times.</p> <ul style="list-style-type: none"> • Time can be set in 5-minute increments. * Clock setting is required. 	24
	Auto-Off timer	<p>Use to set the Auto-Off time.</p> <ul style="list-style-type: none"> • Time can be set to a value from 30 to 240 in 10-minute increments. 	26
Weekly timer		<p>Use to set the weekly operation On / Off times.</p> <ul style="list-style-type: none"> • Up to eight operation patterns can be set for each day. * Clock setting is required. * Not valid when the On/Off timer is enabled. 	32
OU silent mode		<p>Use to set the time periods in which priority is given to quiet operation of outdoor units over temperature control. Set the Start/Stop times for each day of the week.</p> <ul style="list-style-type: none"> • Select the desired silent level from "Normal," "Middle," and "Quiet." * Clock setting is required. 	38
Restriction	Temp. range	<p>Use to restrict the preset temperature range.</p> <ul style="list-style-type: none"> • Different temperature ranges can be set for different operation modes. 	42
	Operation lock	<p>Use to lock selected functions.</p> <ul style="list-style-type: none"> • The locked functions cannot be operated. 	44
Energy saving	Auto return	<p>Use to get the units to operate at the preset temperature after performing energy-save operation for a specified time period.</p> <ul style="list-style-type: none"> • Time can be set to a value from 30 and 120 in 10-minute increments. * This function will not be valid when the preset temperature ranges are restricted. 	34
	Schedule	<p>Set the start/stop times to operate the units in the energy-save mode for each day of the week, and set the energy-saving rate.</p> <ul style="list-style-type: none"> • Up to four energy-save operation patterns can be set for each day. • Time can be set in 5-minute increments. • Energy-saving rate can be set to a value from 0% and 50 to 90% in 10% increments. * Clock setting is required. 	36
Night setback		<p>Use to make Night setback settings.</p> <ul style="list-style-type: none"> • Select "Yes" to enable the setting, and "No" to disable the setting. The temperature range and the start/stop times can be set. * Clock setting is required. 	40
Filter information		<p>Use to check the filter status.</p> <ul style="list-style-type: none"> • The filter sign can be reset. 	28
Error information		<p>Use to check error information when an error occurs.</p> <ul style="list-style-type: none"> • Error code, error source, refrigerant address, unit model, manufacturing number, contact information (dealer's phone number) can be displayed. * The unit model, manufacturing number, and contact information need to be registered in advance to be displayed. 	30
Maintenance	Auto descending panel	Auto descending panel (Optional parts) Up / Down you can do.	45
	Manual vane angle	Use to set the vane angle for each vane to a fixed position.	46
Initial setting	Main/Sub	When connecting two remote controllers, one of them needs to be designated as a sub controller.	48
	Clock	Use to set the current time.	49
	Main display	Use to switch between "Full" and "Basic" modes for the Main display.	50
	Contrast	Use to adjust screen contrast.	51

Setting and display items		Setting details	Reference page
Initial setting	Display details	Make the settings for the remote controller related items as necessary. Clock: The factory settings are "Yes" and "24h" format. Temperature: Set either Celsius (°C) or Fahrenheit (°F). Room temp. : Set Show or Hide. Auto mode: Set the Auto mode display or Only Auto display.	52
	Auto mode	Whether or not to use the AUTO mode can be selected by using the button. This setting is valid only when indoor units with the AUTO mode function are connected.	54
	Administrator password	The administrator password is required to make the settings for the following items. • Timer setting • Energy-save setting • Weekly timer setting • Restriction setting • Outdoor unit silent mode setting • Night set back	55
	Language selection	Use to select the desired language.	56
Service	Test run	Select "Test run" from the Service menu to bring up the Test run menu. • Test run • Drain pump test run	58
	Input maintenance	Select "Input maintenance info." from the Service menu to bring up the Maintenance information screen. The following settings can be made from the Maintenance Information screen. • Model name input • Serial No. input • Dealer information input	60
	Function setting (Mr. Slim)	Make the settings for the indoor unit functions via the remote controller as necessary.	64
	Function setting (City Multi)	Use to make setting for indoor units function.	68
	LOSSNAY setting (City Multi only)	This setting is required only when the operation of City Multi units is interlocked with LOSSNAY units.	70
	Check	Error history: Display the error history and execute delete error history. Refrigerant leak check: Refrigerant leaks can be judged. Smooth maintenance: The indoor and outdoor maintenance data can be displayed. Request cord: Details of the operation data including each thermistor temperature and error history can be checked.	72
	Self check	Error history of each unit can be checked via the remote controller.	77
	Maintenance password	Take the following steps to change the maintenance password.	78
Remote controller check	When the remote controller does not work properly, use the remote controller checking function to troubleshoot the problem.	79	

Remote controller function

* The functions which can be used are restricted according to the model.

○ : Supported × : Unsupported

	Function	PAR-31MAA		PAR-21MAA
		Slim	City multi	
Body	Product size H x W x D (mm)	120 x 120 x 19		120 x 130 x 19
	LCD	Full Dot LCD		Partial Dot LCD
	Backlight	○		×
Energy-saving	Energy-saving operation schedule	○	×	×
	Automatic return to the preset temperature	○		×
Restriction	Setting the temperature range restriction	○		○
Function	Operation lock function	○		○
	Weekly timer	○		×
	On / Off timer	○		○
	High Power	○	×	×
	Manual vane angle	○		○

	Function	PAR-31MAA		PAR-21MAA
		Slim	City multi	
Maintenance	Auto descending panel operation		○	○
	Clock		○	×
	Language selection		○	○
	Night setback		○	×
	Smooth maintenance	○	×	○
	Refrigerant leak check	○	×	×
Support	Contact information (Manual entry)		○	○
	Model name Serial No (Manual entry)		○	×

Icon explanations

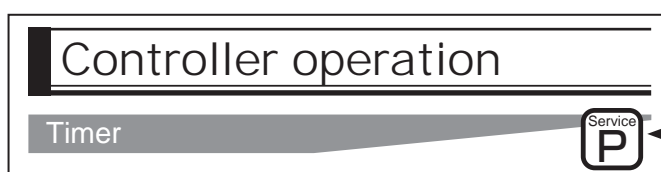

The table below summarizes the square icons used in this manual.

 	<p>The administrator password must be entered on the password input screen to change settings. There is no settings that can skip this process.</p> <p>F1 : Press to move the cursor left. F2 : Press to move the cursor right. F3 : Press to decrease the value by 1. F4 : Press to increase the value by 1.</p> <p>*Changes cannot be made unless the correct password is entered.</p>	<p>Indicates settings that can be made only from the main remote controller.</p>
<p>Indicates settings that can be changed only while the units are in operation.</p>	<p>Indicates settings that can be changed only while the units are not in operation.</p>	
<p>Indicates settings that can be changed only while the units are operated in the Cool, Heat, or Auto mode.</p>	<p>Indicates functions that are not available when the buttons are locked or the system is centrally controlled.</p>	
<p>Both the main remote controller and sub remote controller can be operated.</p>	 <p>Indicates the target model (Mr. Slim air conditioner / City Multi air conditioner) equipped with each function.</p>	

Restrictions for the sub remote controller

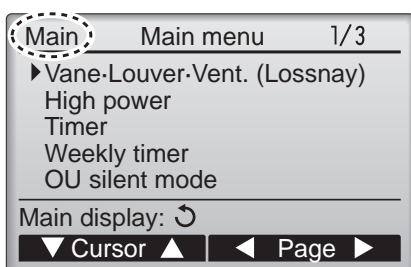

The following settings cannot be made from the sub remote controller. Make these settings from the main remote controller. "Main" is displayed in the title of the Main menu on the main remote controller.

- Timer (On / Off timer, Auto-Off timer)
- Weekly timer
- OU silent mode
- Energy saving (Auto return, Schedule)
- Night setback
- Maintenance (Manual vane angle)

Controller operation : Basic operations

Power ON / OFF



Button operation

[ON]



Press the **[ON/OFF]** button.
The ON / OFF lamp will light up in green, and the operation will start.

[OFF]



Press the **[ON/OFF]** button again.
The ON / OFF lamp will come off, and the operation will stop.

Operation status memory

	Remote controller setting
Operation mode	Operation mode before the power was turned off
Preset temperature	Preset temperature before the power was turned off
Fan speed	Fan speed before the power was turned off

Settable preset temperature range

Operation mode	Preset temperature range
Cool/Dry	19 ~ 30 °C (67 ~ 87 °F)
Heat	17 ~ 28 °C (63 ~ 83 °F)
Auto (Single set point)	19 ~ 28 °C (67 ~ 83 °F)
Auto (Dual set points)	[Cool] Preset temperature range for the Cool mode [Heat] Preset temperature range for the Heat mode
Fan/Ventilation	Not settable

The settable temperature range varies with the model of indoor units.

Button operation

[Operation mode]

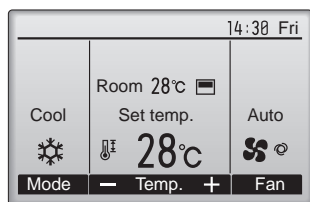

Press the **F1** button to go through the operation modes in the order of "Cool, Dry, Fan, Auto, and Heat." Select the desired operation mode.

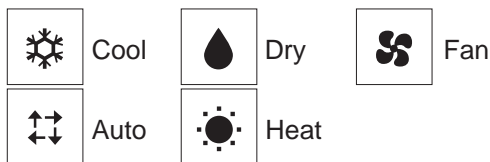

- Operation modes that are not available to the connected indoor unit models will not appear on the display.

<Automatic operation>

- According to a set temperature, cooling operation starts if the room temperature is too hot and heating operation starts if the room temperature is too cold.
- During automatic operation, if the room temperature changes and remains 2°C or more above the set temperature for 15 minutes, the air conditioner switches to cooling mode. In the same way, if the room temperature remains 2°C or more below the set temperature for 15 minutes, the air conditioner switches to heating mode.

<What the blinking mode icon means>

The mode icon will blink when other indoor units in the same refrigerant system (connected to the same outdoor unit) are already operated in a different mode. In this case, the rest of the unit in the same group can only be operated in the same mode.

<AUTO (dual set point) mode>

When the operation mode is set to the Auto (dual set point) mode, two preset temperatures (one each for cooling and heating) can be set. Depending on the room temperature, indoor unit will automatically operate in either the Cool or Heat mode and keep the room temperature within the preset range.

The graph below shows the operation pattern of indoor unit operated in the Auto (dual set point) mode.

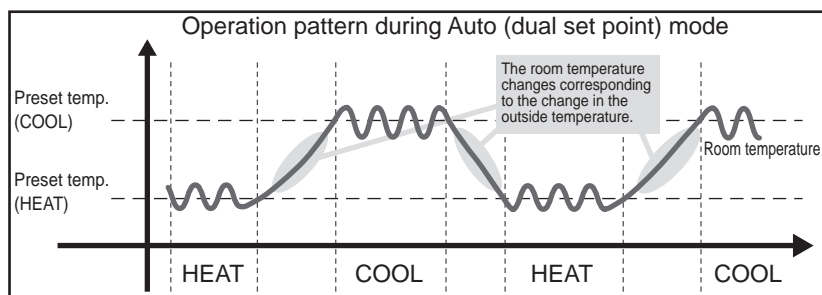

[Preset temperature]

<Cool, Dry, Heat, and Auto (single set point)>

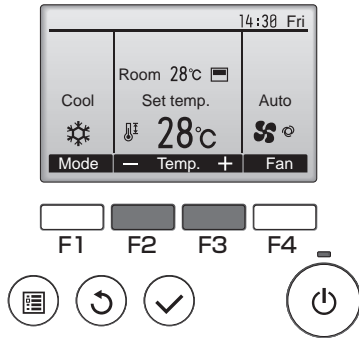

Press the **[F2]** button to decrease the preset temperature, and press the **[F3]** button to increase.

- Refer to the table on page 13 for the settable temperature range for different operation modes.
- Preset temperature range cannot be set for Fan/Ventilation operation.
- Preset temperature will be displayed either in Centigrade in 0.5- or 1-degree increments, or in Fahrenheit, depending on the indoor unit model and the display mode setting on the remote controller.

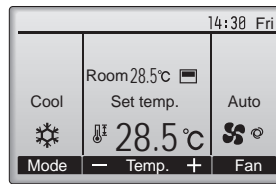

Example display
(Centigrade in 0.5-degree increments)

<Auto (dual set point) mode>

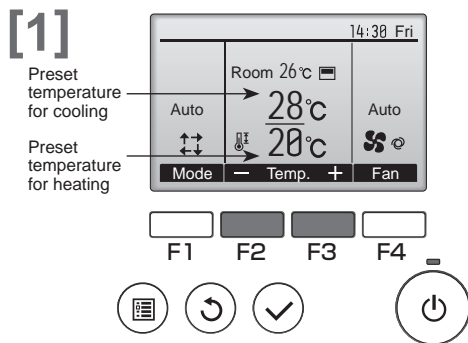

Note: Depend on models for Mr. Slim

The current preset temperatures will appear.
Press the **[F2]** or **[F3]** button to display the Settings screen.

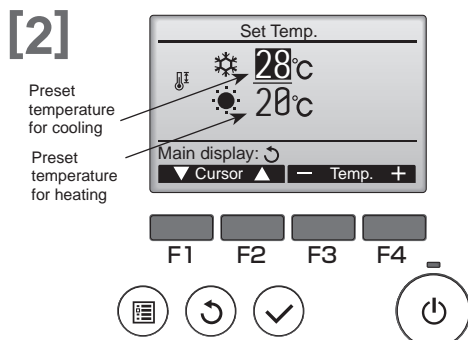

Press the **[F1]** or **[F2]** button to move the cursor to the desired temperature setting (cooling or heating).

Press the **[F3]** button to decrease the selected temperature, and **[F4]** to increase.

- Refer to the table on page 13 for the settable temperature range for different operation modes.
 - The preset temperature settings for cooling and heating in the Auto (dual set point) mode are also used by the Cool/Dry and Heat modes.
 - The preset temperatures for cooling and heating in the Auto (dual set point) mode must meet the conditions below:
 - Preset cooling temperature is higher than preset heating temperature.
 - The minimum temperature difference requirement between cooling and heating preset temperatures (varies with the models of indoor units connected) is met.
- * If preset temperatures are set in a way that does not meet the minimum temperature difference requirement, both preset temperatures will automatically be changed within the allowable setting ranges.

Navigating through the screens

- To return to the Main screen **[RETURN]** button

[Fan speed]

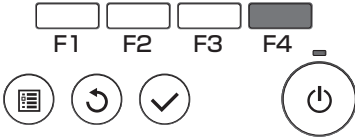
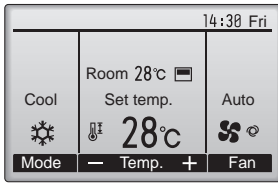

Press the **F4** button to go through the fan speeds in the following order.

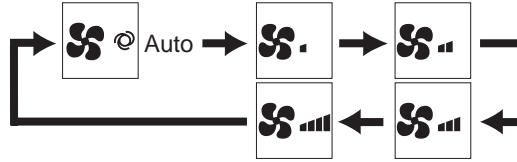

•The available fan speeds depend on the models of connected indoor units.

Navigating through the Main menu

Button operation

[Accessing the Main menu]

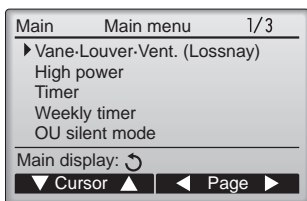

Press the  button.

The Main menu will appear.



[Item selection]

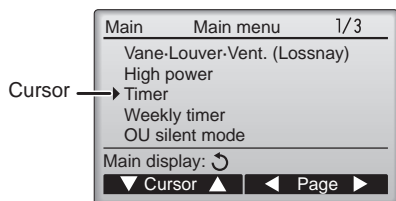

Press **F1** to move the cursor down.

Press **F2** to move the cursor up.



[Navigating through the pages]

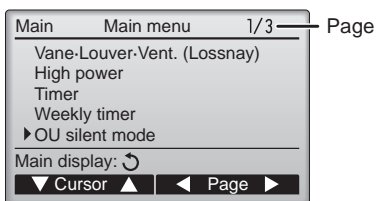

Press **F3** to go to the previous page.

Press **F4** to go to the next page.



[Saving the settings]



Select the desired item, and press the button.

The screen to set the selected item will appear.

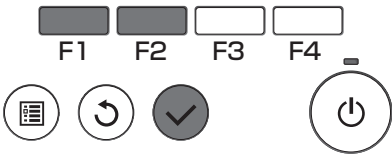

[Exiting the Main menu screen]

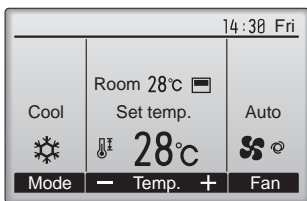

Press the button to exit the Main menu and return to the Main display.

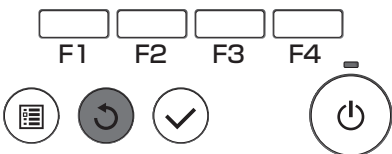

If no buttons are touched for 10 minutes, the screen will automatically return to the Main display. Any settings that have not been saved will be lost.

[Display of unsupported functions]

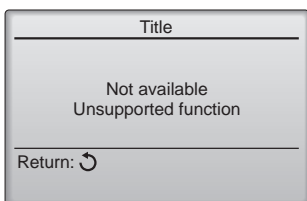

The message at left will appear if the user selects a function not supported by the corresponding indoor unit model.

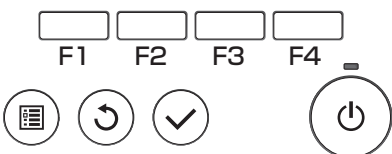

Button operation

[Accessing the menu]

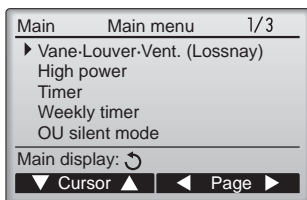

Select "Vane · Louver · Vent. (Lossnay)" from the Main menu (refer to page 19), and press the button.

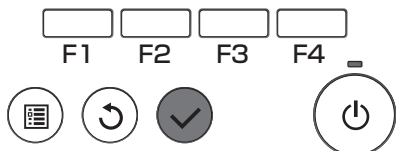

[Vane setting]

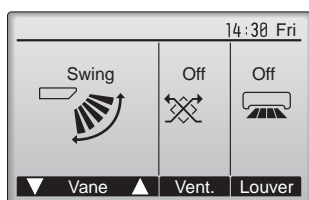

Press the **F1** or **F2** button to go through the vane setting options: "AUTO", "Step 1", "Step 2", "Step 3", "Step 4", "Step 5" and "Swing."

Select the desired setting.

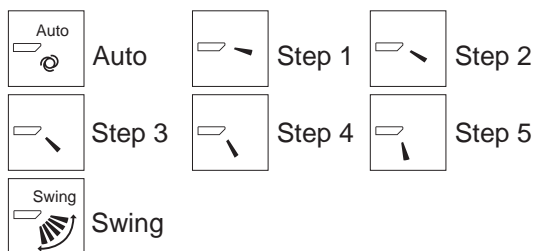
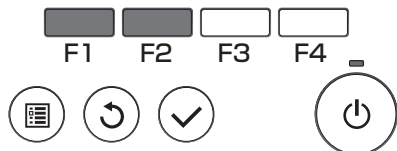

(Sample screen on City Multi)

Select "Swing" to move the vanes up and down automatically. When set to "Step 1" through "Step 5", the vane will be fixed at the selected angle.

※ If the i-see sensor is provided, the auto wind direction will be applied in the area i-see sensor in which the up/down wind direction is automatically controlled.

The area i-see sensor calculates the sensed temperature per blowoff area, and controls the wind direction in the following manner.

- When heating: If the area temperature differs, the wind direction is controlled as shown on the right. When the temperature difference decreases, the wind is set to downward blow (setting 5).
- When cooling: If the area temperature differs, the wind direction is controlled as shown on the right. When the temperature difference decreases, the wind is set to horizontal (setting 1).

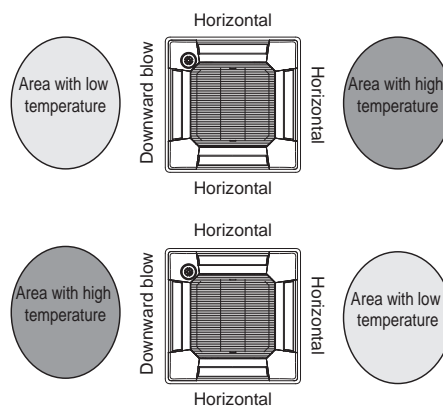

<<Other models>>

- Cooling, ventilation or dry mode: "Setting 1"
- Heating mode: "Setting 4" (If the unit has a "Setting 5", it will be applied.)

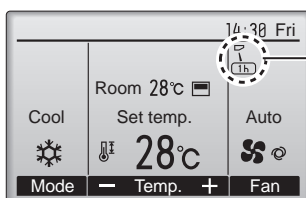

under the vane setting icon
 This icon will appear when the vane is set to "Step 5" and the fan operates at low speed during cooling or dry operation (depends on the model). The icon will go off in an hour, and the vane setting will automatically change.

[Louver setting]

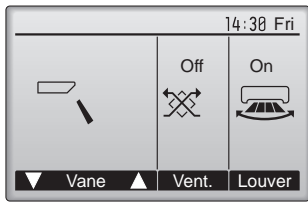

Press the **F4** button to turn the louver swing ON and OFF.



(Sample screen on City Multi)

[Vent. setting]

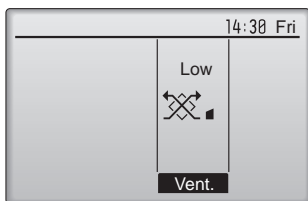

Press the **F3** button to go through the ventilation setting options in the order of "Off," "Low," and "High."

* Settable only when LOSSNAY unit is connected.



(Sample screen on Mr. Slim)

• The fan on some models of indoor units may be interlocked with certain models of ventilation units.

[Returning to the Main menu]

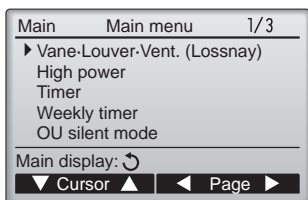

Press the **Back** button to go back to the Main menu.



High power



High-power operation function allows the units to operate at higher-than-normal capacity so that the room air can be conditioned to an optimum temperature quickly. This operation will last for up to 30 minutes, and the unit will return to the normal operation mode at the end of the 30 minutes or when the room temperature reaches the preset temperature, whichever is earlier. The units will return to the normal operation when the operation mode or fan speed is changed.

Button operation

[1]

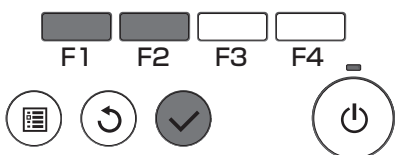
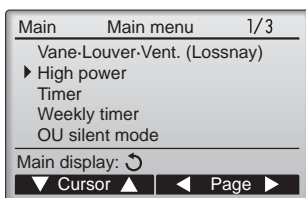

Select "High power" from the Main menu during Cooling, Heating, or AUTO operation (refer to page 19), and press the button.

"High power" operation is valid only with models which support high power operation.

[2]

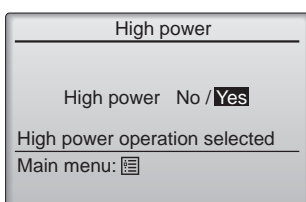
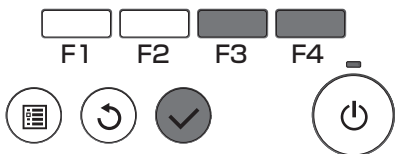
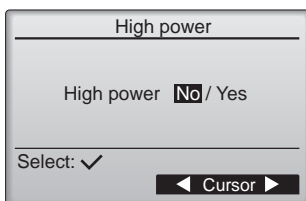

Move the cursor to "YES" with the **F3** or **F4** button, and press the button.

A confirmation screen will appear.

Navigating through the screens

- To go back to the Main menu button
- To return to the previous screen button

On / Off timer

The unit automatically turns on or off at the preset time.
 (ex. Operation start time PM 2:30/ Operation stop time AM 12:50/ only one)

Button operation

Controller operation : Basic operations

[1]

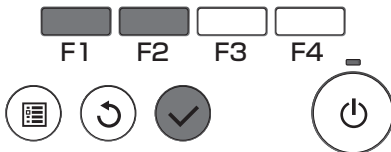
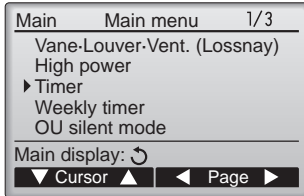

Select "Timer" from the Main menu (refer to page 19), and press the  button.

The On/Off timer will not work in the following cases:

when On/Off timer is disabled, during an error, during check (in the service menu), during test run, during remote controller diagnosis, when the clock is not set, during Function setting, when the system is centrally controlled (when On/Off operation from local controller is prohibited).

[2]

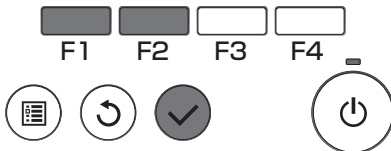
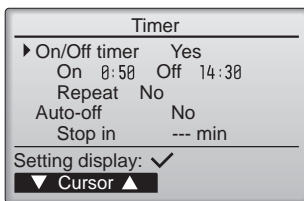

The current settings will appear.

Move the cursor to the On / Off timer, and press the  button.



Administrator password setting. (Refer to page 55)

[3]

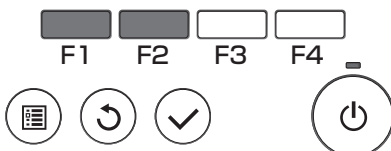
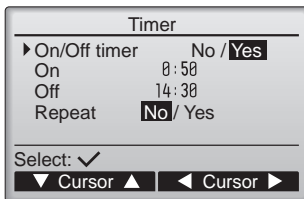

The screen to set the timer will appear.

Select the desired item with the **F1** or **F2** button out of "On / Off timer", "On", "Off" or "Repeat".

[4]

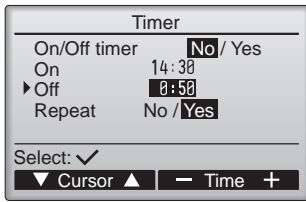

Change the setting with the **F3** or **F4** button.

- **On / Off timer:** No (disable) / Yes (enable)
- **On:** Operation start time (settable in 5-minute increments)
* Press and hold the button to rapidly advance the numbers.
- **Off:** Operation stop time (settable in 5-minute increments)
* Press and hold the button to rapidly advance the numbers.
- **Repeat:** No (once) / Yes (repeat)

[5]

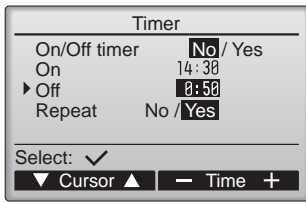

Press the button to save the settings.

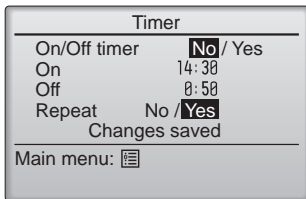

A confirmation screen will appear.

Navigating through the screens

- To go back to the Main menu button
- To return to the previous screen button

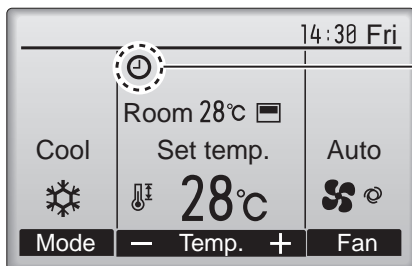

will appear on the Main display in the Full mode when the On/Off timer is enabled.

appears when the timer is disabled by the centralized control system.

Auto-Off timer

Button operation

[1]

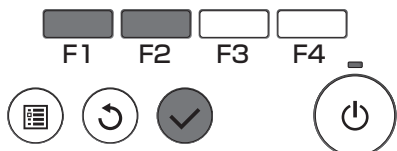
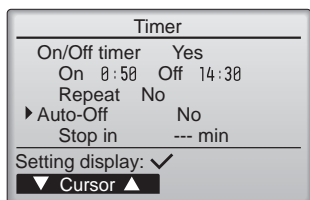

Bring up the Timer setting screen. (Refer to page 24.)

Select "Auto-Off", and press the button.



Administrator password setting. (Refer to page 55)

The Auto-Off timer will not work in the following cases:

when Auto-Off timer is disabled, during an error, during check (in the service menu), during test run, during remote controller diagnosis, when the clock is not set, during Function setting, when the system is centrally controlled (when On/Off operation from local controller is prohibited).

[2]

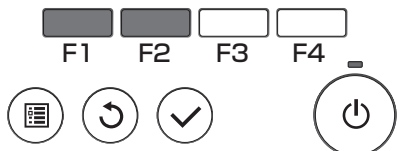
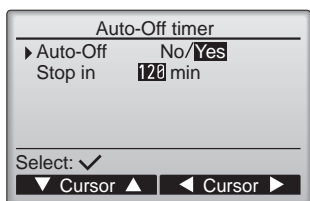

The current settings will appear.

Move the cursor to the "Auto-Off" or "Stop in --- min" with the **F1** or **F2** button.

[3]

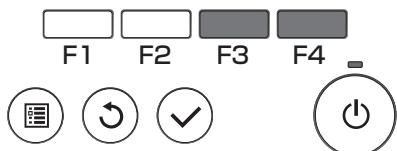
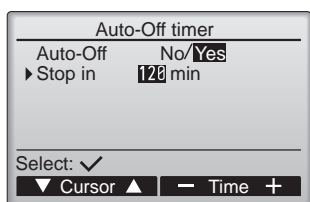

Change the setting with the **F3** or **F4** button.

- **Auto-Off** : No (disable) / Yes (enable)
- **Stop in --- min** : Timer setting
(The settable range is 30 to 240 minutes in 10-minute increments.)

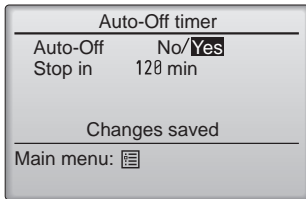
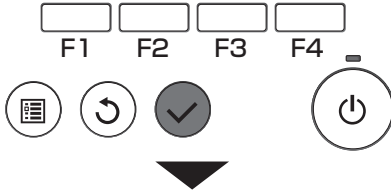
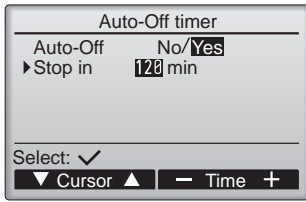

[4]





Press the  button to save the settings.

A confirmation screen will appear.

Navigating through the screens

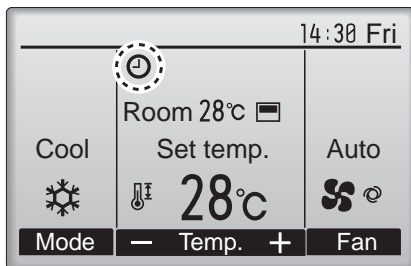
- To go back to the Main menu  button
- To return to the previous screen  button



 will appear on the Main display in the Full mode when the On/Off timer is enabled.

 appears when the timer is disabled by the centralized control system.

Filter information

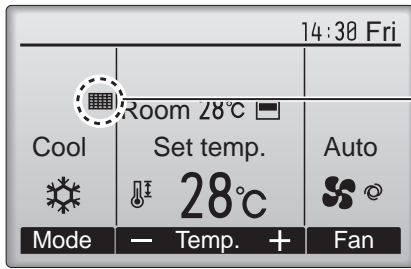

 will appear on the Main display in the Full mode when it is time to clean the filters.
Wash, clean, or replace the filters when this sign appears.
 Refer to the indoor unit Instructions Manual for details.

Controller operation : Basic operations

Button operation

[1]

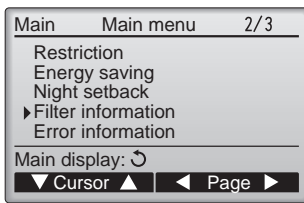

Select "Filter information" from the Main menu (refer to page 19), and press the  button.

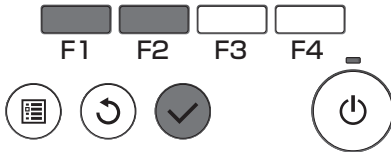

[2]



Press the **F4** button to reset filter sign.

Refer to the indoor unit Instructions Manual for how to clean the filter.

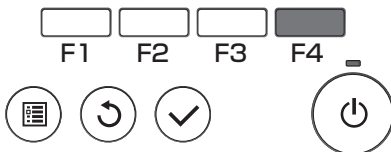

[3]



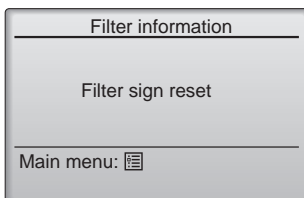
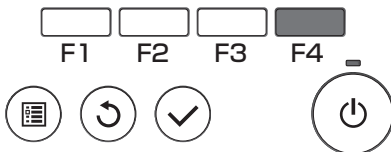

Select "OK" with the **F4** button.



A confirmation screen will appear.

Navigating through the screens

- To go back to the Main menu  or  button

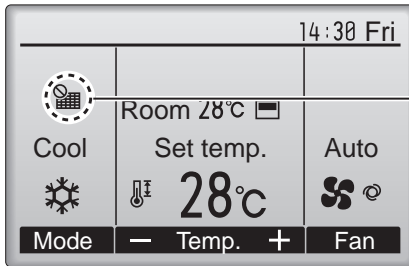

When the  is displayed on the Main display in the Full mode, the system is centrally controlled and the filter sign cannot be reset.

If two or more indoor units are connected, filter cleaning timing for each unit may be different, depending on the filter type.

The icon  will appear when the filter on the main unit is due for cleaning.

When the filter sign is reset, the cumulative operation time of all units will be reset.

The icon  is scheduled to appear after a certain duration of operation, based on the premise that the indoor units are installed in a space with ordinary air quality. Depending on the air quality, the filter may require more frequent cleaning.

The cumulative time at which filter needs cleaning depends on the model.

Error information

When an error occurs, the following screen will appear.
Check the error status, stop the operation, and consult your dealer.

Button operation

Controller operation : Basic operations

[1]

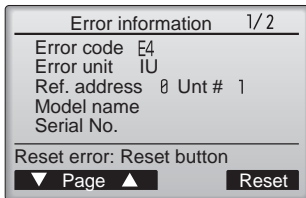

Error code, error unit, refrigerant address, unit model name, and serial number will appear.
The model name and serial number will appear only if the information have been registered.

Press the **F1** or **F2** button to go to the next page.

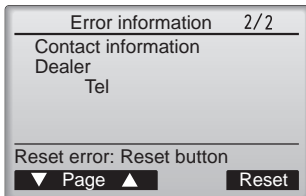
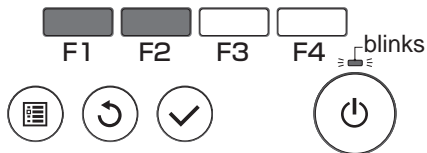

Contact information (dealer's phone number) will appear if the information have been registered.

[2]

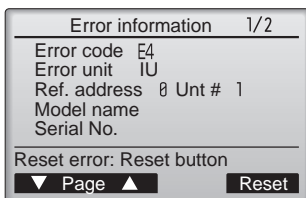

Press the **F4** button or the button to reset the error that is occurring.

Errors cannot be reset while the ON/OFF operation is prohibited.

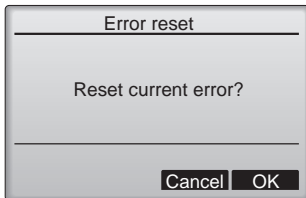
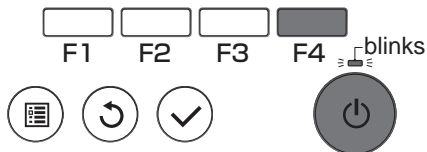

Select "OK" with the **F4** button.

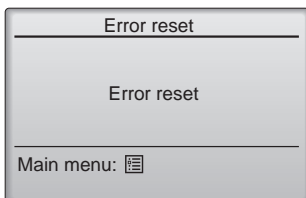

Navigating through the screens

- To go back to the Main menu button

Checking the error information

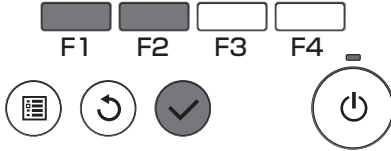
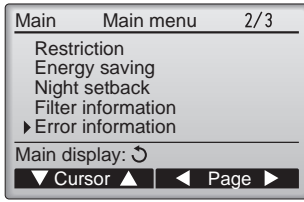

While no errors are occurring, page 2/2 of the error information (refer to page 30) can be viewed by selecting "Error information" from the Main menu (refer to page 19).

Errors cannot be reset from this screen.

Controller operation : Function settings



Weekly timer

- ON / OFF and temperature setting can be scheduled for each day.
- "Weekly timer" is not executed when the On / Off timer is enabled.

Button operation

[1]

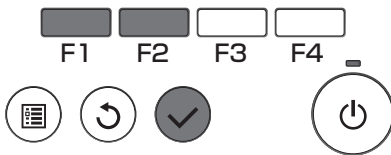
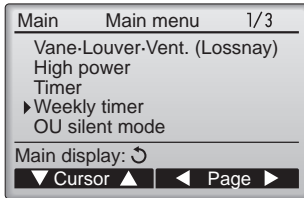

Select "Weekly timer" from the Main menu (refer to page 19), and press the button.

The Weekly timer will not work in the following cases:

when the On / Off timer is enabled, when the weekly timer is disabled, during an error, during check (in the service menu), during test run, during remote controller diagnosis, when the clock is not set, during Function setting, when the system is centrally controlled (On / Off operation or temperature setting from local controller is prohibited).

[2]

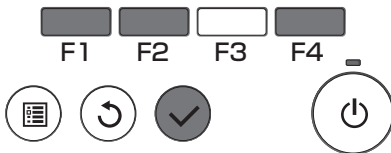
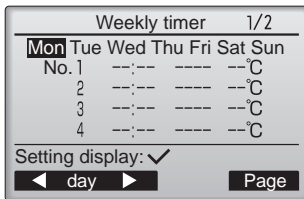

The current settings will appear.

Press the **F1** or **F2** button to see the settings for each day of the week.

Press the **F4** button to see patterns 5 through 8.

Press the button to go to the setting screen.

Administrator password setting. (Refer to page 55)

[3]

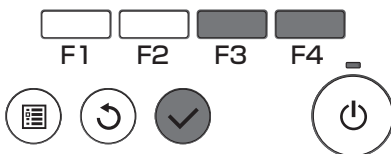
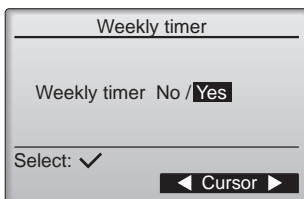

The screen to enable (Yes) and disable (No) the weekly timer will appear.

To enable the setting, move the cursor to "Yes" with the **F3** or **F4** button, and press the button.

[4]

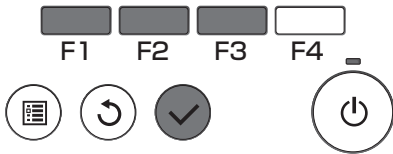
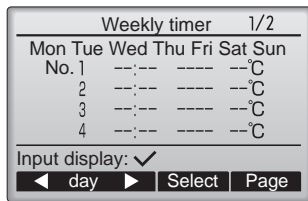

The weekly timer setting screen will appear and the current settings will be displayed.
Up to eight operation patterns can be set for each day.

Move the cursor to the desired day of the week with the **[F1]** or **[F2]** button, and press the **[F3]** button to select it. (Multiple days can be selected.)

Press the button.

[5]

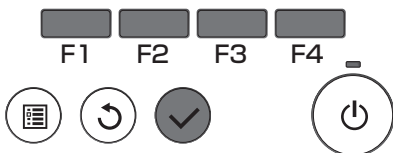
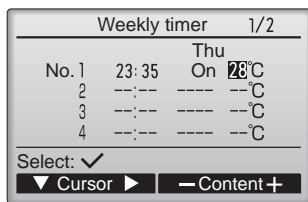

Operation pattern setting screen will appear.

Press the **[F1]** button to move the cursor to the desired pattern number. Move the cursor to the time, On / Off, or temperature with the **[F2]** button. Change the settings with the **[F3]** or **[F4]** button.

- **Time:** settable in 5-minute increments
* Press and hold the button to rapidly advance the numbers.
- **On/Off/Auto:** Selectable settings depend on the model of connected indoor unit. (When an Auto pattern is executed, the system will operate in the Auto (dual set point) mode.)
- **Temperature:** The settable temperature range depends on the connected indoor units. (1°C increments)
When the Auto (dual set point) mode is selected, two preset temperatures can be set. If an operation pattern with a single preset temperature setting is executed during the Auto (dual set point) mode, its setting will be used as the cooling temperature setting in the Cool mode.

Press the button to save the settings.

A confirmation screen will appear.

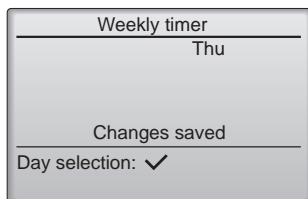

- Navigating through the screens**
- To go back to the setting change/day of the week selection screen
 - To go back to the Main menu.....
 - To return to the previous screen

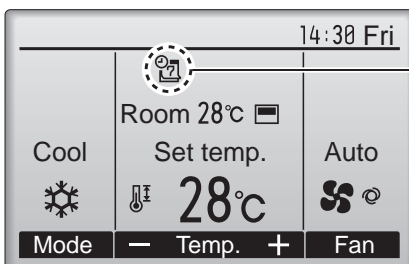

will appear on the Main display in the Full mode when the weekly timer setting for the current day exists.
The icon will not appear while the On/Off timer is enabled or the system is under centralized control (Timer operation from local remote controller is prohibited).

Automatic return to the preset temperature

- The display can be automatically returned to the set temperature after the set time.
- This setting is not executed when the set temperature range limit is valid and during central control (when prohibited item is "set temperature").

Button operation

[1]

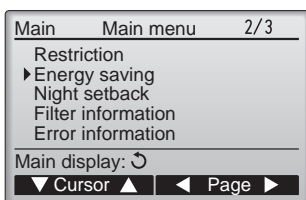

Select "Energy saving" from the Main menu (refer to page 19), and press the button.

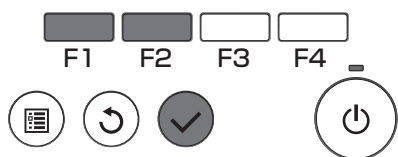

[2]

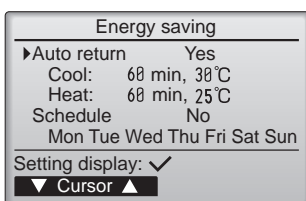

The current settings will appear.

Move the cursor to "Auto return" with the **F1** or **F2** button, and press the button.



Administrator password setting. (Refer to page 55)

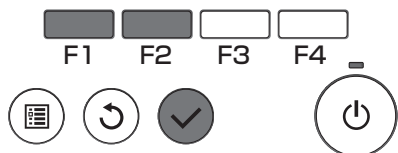

[3]

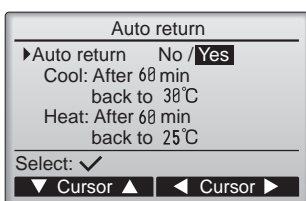

The screen to make the settings for the automatic return to the preset temperature will appear.

Move the cursor to the desired item with the **F1** or **F2** button out of "Auto return", "Cool" or "Heat".

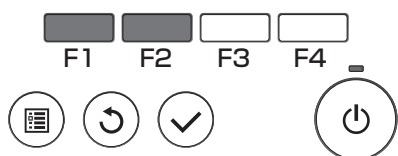

[4]

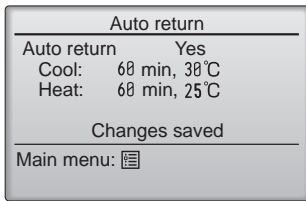
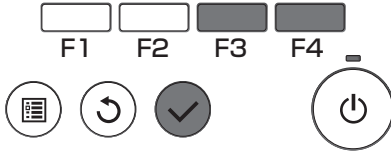
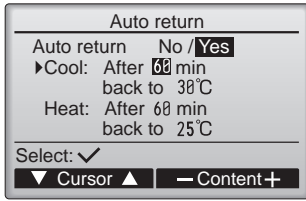

Change the settings with the **F3** or **F4** button.

- **Auto return:** No (disable) / Yes (enable)
- **Cool:** Timer setting range is 30 to 120 minutes in 10-minute increments. Temperature setting range is 19 to 30°C (67 to 87°F) (1°C increments).
- **Heat:** Timer setting range is 30 to 120 minutes in 10-minute increments. Temperature setting range is 17 to 28°C (63 to 83°F) (1°C increments).

"Cool" includes "Dry" and "AUTO Cooling" modes, and "Heat" includes "AUTO Heating" mode.

Press the button to save the settings.

The screen to set the selected item will appear.

Navigating through the screens

- To go back to the Main menu button
- To return to the previous screen button

The above Timer or Preset temperature settings will not be effective when the Temp. range is restricted and when the system is centrally controlled (when the Temp. range setting from local controller is prohibited). When the system is centrally controlled (when Timer operation from local remote controller is prohibited), only the Timer setting will be ineffective.

<Sample screens when the Auto return function is enabled>

Example: Lower the Set temp. to 24°C (75°F). 60 minutes later, the Set temp. will be back to 28°C (83°F).

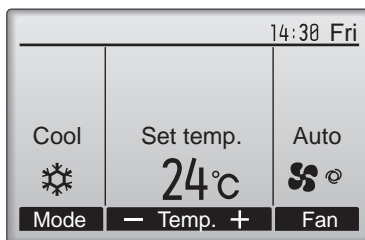
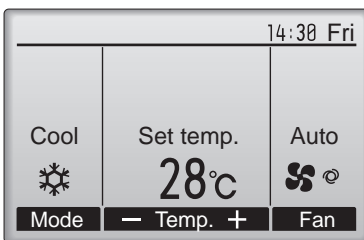

60 minutes later

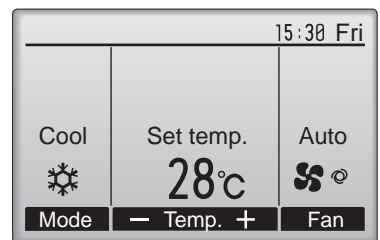

The Set temp. is changed from 28°C (83°F) to 24°C (75°F) by a user.

60 minutes later, the Set temp. returns to 28°C (83°F) automatically.

Setting the energy-saving operation schedule

Set the Energy-saving operation start time, end time and performance save value for one week.

Button operation

Controller operation : Function operations

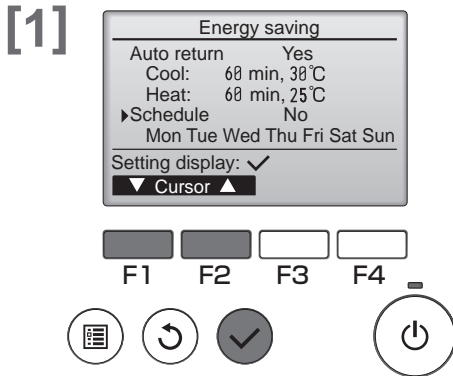

Bring up the "Energy saving" screen. (refer to page 36)

Move the cursor to the "Schedule," and press the button.

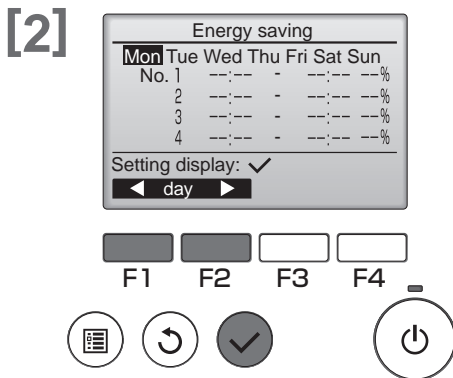

The screen to see the schedule will appear.

Press the **F1** or **F2** button to see the settings for each day of the week.

Press the button to go to the setting screen.



Administrator password setting. (Refer to page 55)

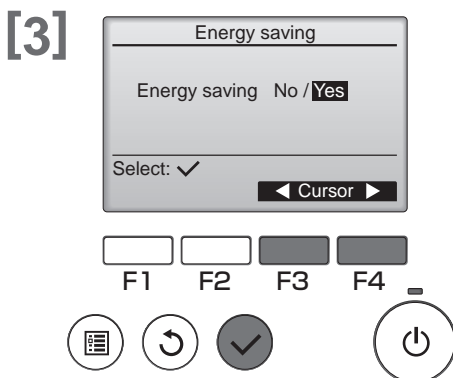

The screen to enable (Yes)/disable (No) the energy-saving operation schedule will appear.

Select "No" or "Yes" with the **F3** or **F4** button.



Press the button to go to the setting change/day of the week selection screen.

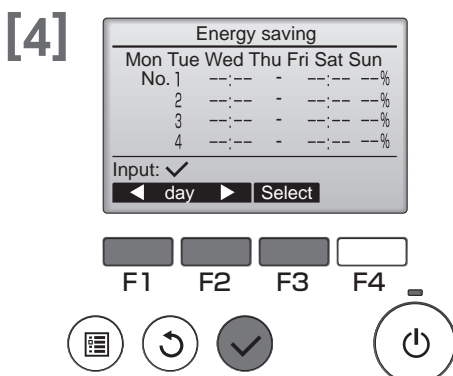

The setting change / day of the week selection screen will appear.
* Up to four operation patterns can be set for each day.

Move the cursor to the desired day of the week with the **F1** or **F2** button, and press the **F3** button to select it. (Multiple days can be selected.)



Press the button to go to the pattern setting screen.

[5]

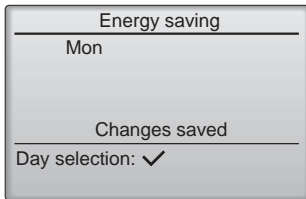
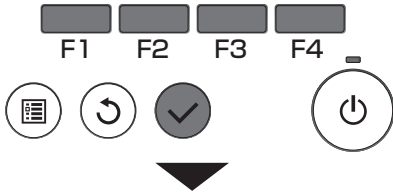
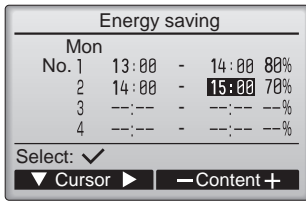

The pattern setting screen will appear.

Press the **[F1]** button to move the cursor to the desired pattern number.

Move the cursor to the desired item with the **[F2]** button out of the start time, stop time, and energy-saving rate (arranged in this order from the left).

Change the settings with the **[F3]** or **[F4]** button.

- **Start/Stop time:** settable in 5-minute increments
* Press and hold the button to rapidly advance the numbers.
- **Energy-saving rate:** The setting range is 0%, 50%, 60%, 70%, 80%, 90%.

Press the **[Checkmark]** button to save the settings.

A confirmation screen will appear.

- The lower the value, the greater the energy-saving effect.
- If the start time, end time or performance save value is "-----", control cannot be executed with the settings.

Navigating through the screens

- To go back to the setting change/day of the week selection screen **[Checkmark]** button
- To go back to the Main menu..... **[List]** button
- To return to the previous screen **[Refresh]** button

◆ Overlapping times can be set. Refer to <Example 2> for details on the operation methods.

<Example1>

- pattern1/ 8:15~12:00/ 90%
- pattern2/ 12:00~17:00/ 80%
- pattern3/ 18:00~21:00/ 90%
- pattern4/ 8:15~12:00/ 90%

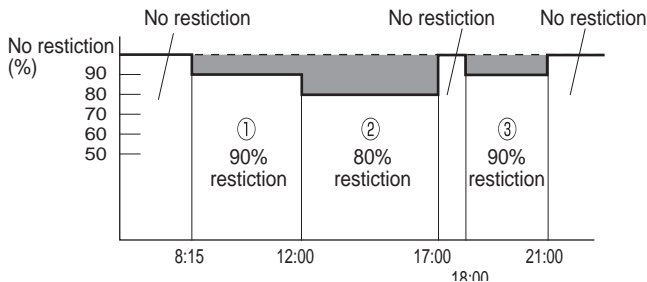

<Example2>

- pattern1/ 8:15~21:00/ 90%
- pattern2/ 12:00~16:00/ 70%
- pattern3/ 16:00~19:00/ 90%
- pattern4/

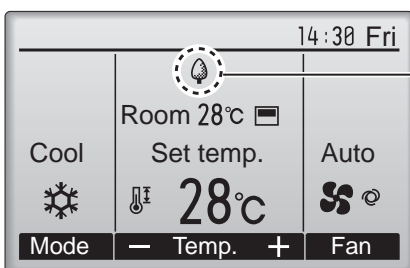
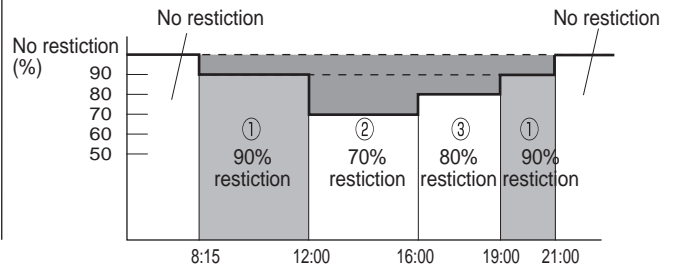

will appear on the Main display in the Full mode when the unit is operated in the energy saving mode.

Settings can be made with external inputs to the outdoor unit. (refer to page 89)

This function allows the user to set the time periods in which priority is given to quiet operation of outdoor units over temperature control. Set the start and stop times each day of the week for the quiet operation. Select the desired silent level from "Middle" and "Quiet".

Button operation

[1]

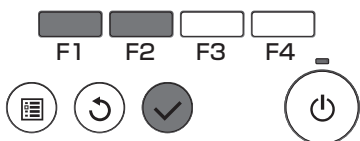
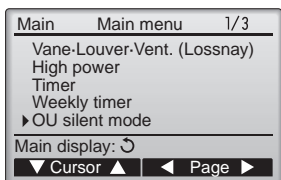

Select "OU silent mode" from the Main menu (refer to page 19), and press the button.

"OU silent mode" function is available only on the models that support the function.

[2]

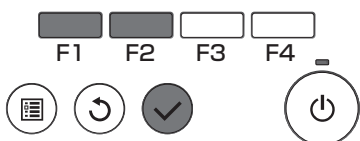

The current settings will appear.

Press the **F1** or **F2** button to see the settings for each day of the week.



Press the button to go to the setting screen.

[3]

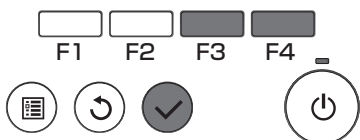
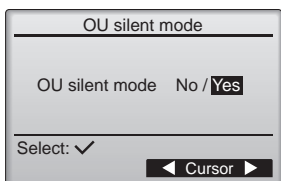

The screen to enable (Yes) and disable (No) the silent mode will appear.

To enable this setting, move the cursor to "Yes" with the **F3** or **F4** button, and press the button .

[4]

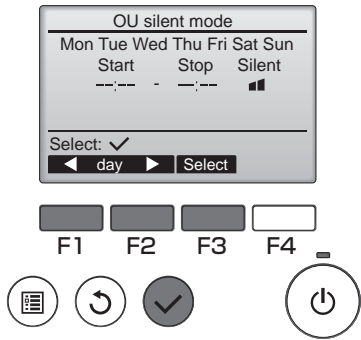

The OU silent mode setting screen will appear.

To make or change the setting, move the cursor to the desired day of the week with the **[F1]** or **[F2]** button, and press the **[F3]** button to select it. (Multiple days can be selected.)

Press the button.

[5]

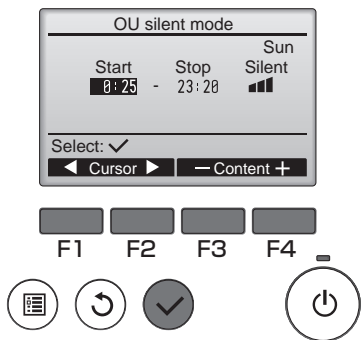

The setting screen will appear.

Move the cursor to the desired item with the **[F1]** or **[F2]** button out of Start time, Stop time, or Silent level.

Change the settings with the **[F3]** or **[F4]** button.

- Start/Stop time: settable in 5-minute increments
- * Press and hold the button to rapidly advance the numbers.
- Silent level: Normal, Middle, Quiet



Press the button to save the settings. A confirmation screen will appear.

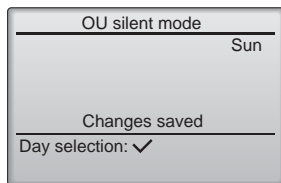

Navigating through the screens

- To go back to the setting change/day of the week selection screen button
- To go back to the Main menu button
- To return to the previous screen button

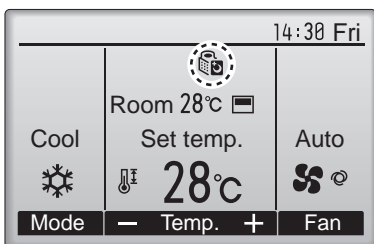

will appear on the Main display in the Full mode during the OU silent mode.

Night setback

This control starts heating operation when the control object group is stopped and the room temperature drops below the pre-set lower limit temperature. Also, this control starts cooling operation when the control object group is stopped and the room temperature rises above the preset upper limit temperature.

The Night setback function is not available if the operation and the temperature setting are performed from the remote controller.

If the room temperature is measured by the air-conditioner's suction temperature sensor, the accurate temperature may not be obtained when the air-conditioner is inactive or when the air is not clean. In this case, switch the sensor to a remote sensor (PAC-SE40TSA/PAC-SE41TS-E) or a remote control sensor.

Button operation

Controller operation : Function operations

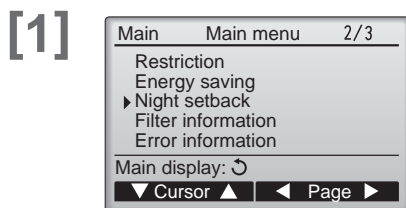

Select "Night setback" from the Main menu (refer to page 19), and press the button.

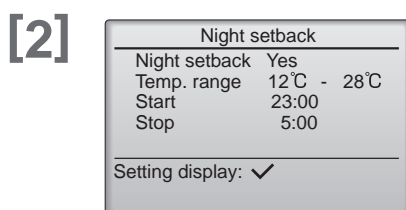
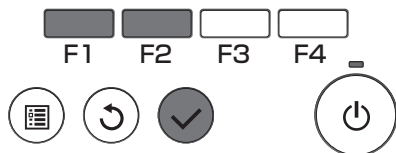

The current settings will appear.

Press the button to go to the setting screen.

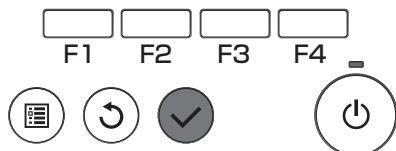

Administrator password setting. (Refer to page 55)

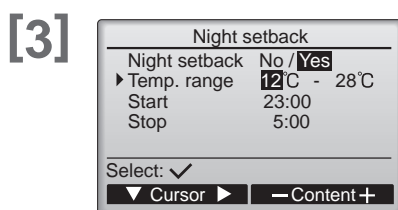

Move the cursor to the desired item with the **F1** or **F2** button out of Night setback No (disable)/Yes (enable), Temp. range, Start time, or Stop time.

Change the settings with the **F3** or **F4** button.

- **Temp. range:** The lower limit temperature (for heating operation) and the upper limit temperature (for cooling operation) can be set. The temperature difference between the lower and upper limits must be 4°C (8°F) or more. The settable temperature range varies depending on the connected indoor units.
- **Start/Stop time:** settable in 5-minute increments
- * Press and hold the button to rapidly advance the numbers.

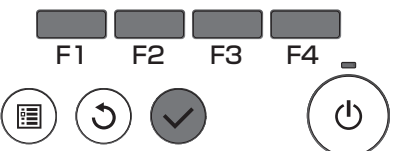

Press the button to save the settings.

A confirmation screen will appear.

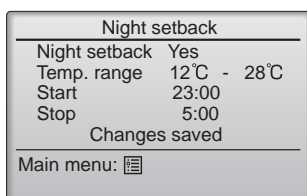

Navigating through the screens

- To go back to the Main menu button
- To return to the previous screen button

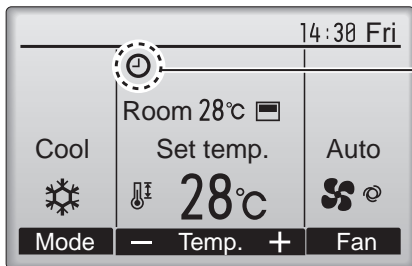

 will appear on the Main display in the Full mode when the Night setback function is enabled.

 appears when the timer is disabled by the centralized control system.

The Night setback will not work in the following cases:
 when the unit is in operation, when the Night setback function is disabled, during an error, during check (in the service menu), during test run, during remote controller diagnosis, when the clock is not set, during Function setting, when the system is centrally controlled (On/Off operation or temperature setting from local controller is prohibited).

Setting the temperature range restriction

Use to restrict the preset temperature range.

Button operation

[1]

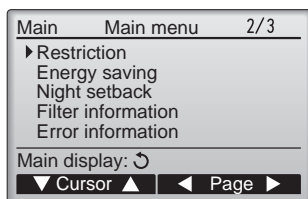

Select "Restriction" from the Main menu (refer to page 19), and press the button.

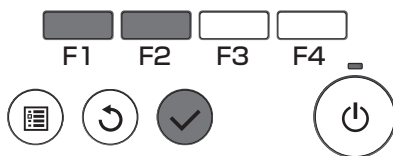

[2]

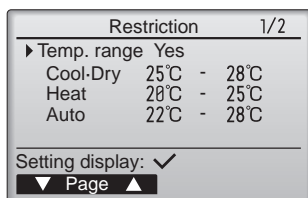

The current settings will appear.

Move the cursor to "Temp. range" with the **F1** or **F2** button, and press the button.



Administrator password setting. (Refer to page 55)

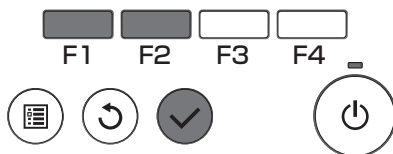

[3]

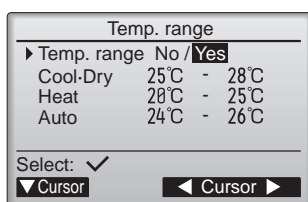

The screen to set the temperature range will appear.

Move the cursor to the desired item with the **F1** button out of "Temp. range", "Cool · Dry", "Heat" or "Auto."

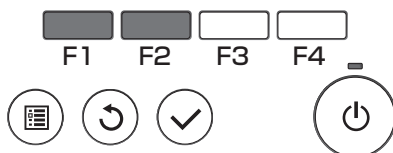

[4]

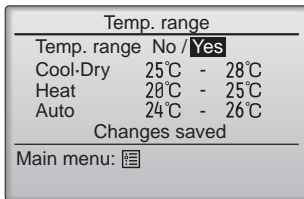
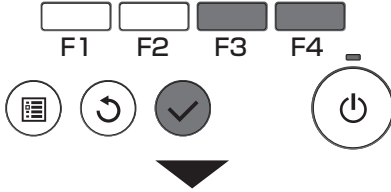
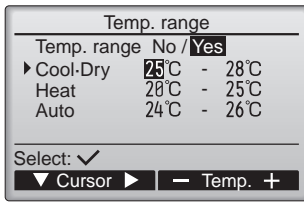

Change the settings with the **F3** or **F4** button.

- **Temp. range:** No (unrestricted) or Yes (restricted)
- **Cool - Dry:** Upper and lower limit temperature (1°C increments)
- **Heat:** Upper and lower limit temperature (1°C increments)
- **Auto:** Upper and lower limit temperature (1°C increments)

<Temperature setting ranges>

Mode	Lower limit	Upper limit
Cool · Dry *1 *3	19 – 30°C (67 – 87°F)	30 – 19°C (87 – 67°F)
Heat *2 *3	17 – 28°C (63 – 83°F)	28 – 17°C (83 – 63°F)
Auto *4	19 – 28°C (67 – 83°F)	28 – 19°C (83 – 67°F)

* The settable range varies depending on the connected unit.

*1 Temperature ranges for the Cool, Dry, and Auto (dual set point) modes can be set.

*2 Temperature ranges for the Heat and Auto (dual set point) modes can be set.

*3 Temperature ranges for the Heat, Cool, and Dry modes must meet the conditions below:

- Upper limit for cooling - upper limit for heating ≥ Minimum temperature difference (varies with indoor unit model)
- Lower limit for cooling - lower limit for heating ≥ Minimum temperature difference (varies with indoor unit model)

*4 Temperature range for the Auto (single set point) mode can be set.

Press the button to save the settings.

A confirmation screen will appear.

Navigating through the screens

- To go back to the Main menu button
- To return to the previous screen button

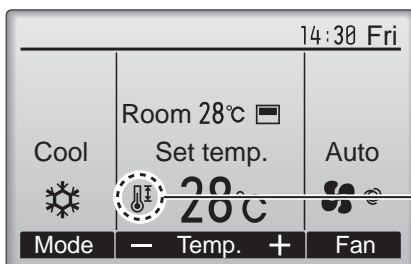

will appear on the Main display in the Full mode when the temperature range is restricted.

Operation lock function

- To enable the operation lock function, set the item "Operation locked" to "Yes".
- The On / Off operation, Operation mode setting, Preset temp, Setting and Vane Setting operations can all be restricted.

Button operation

[1]

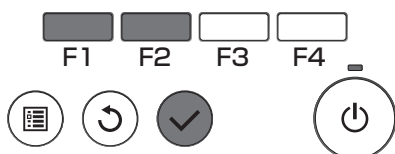
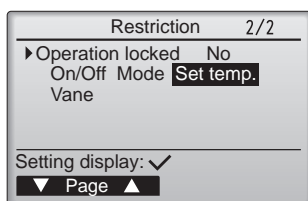

Bring up the Restriction setting screen. (refer to page 42)

Move the cursor to "Operation locked" and press the button.



Administrator password setting. (Refer to page 51)

[2]

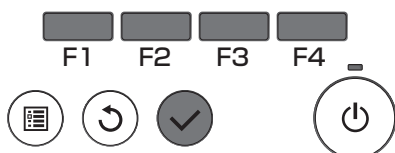
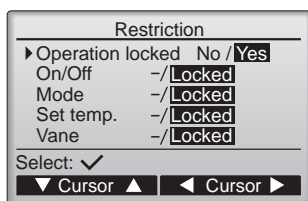

The screen to make the settings for the operation lock function will appear.

Move the cursor to the desired item with the **F1** or **F2** button out of "Operation locked", "On / Off", "Mode", "Set temp.", or "Vane".

Change the settings with the **F3** or **F4** button.

- **Operation locked:** No (disable) / Yes (enable)
- **On / Off:** On / Off operation
- **Mode:** Operation mode setting
- **Set temp.:** Preset temp. setting
- **Vane:** Vane setting

Press the button to save the settings.

A confirmation screen will appear.

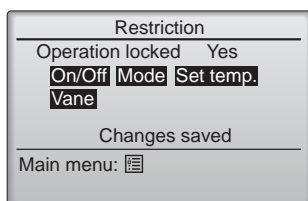

Navigating through the screens

- To go back to the Main menu button
- To return to the previous screen button

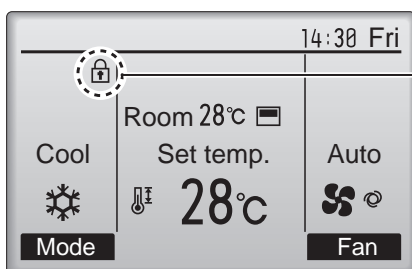

(When Set temp. is locked)

will appear on the Main display in the Full mode when the operation lock function setting is enabled.

Operation guide that corresponds to the locked function will be suppressed.

"Operation locked" will appear if operation is attempted in the "Operation locked" state.

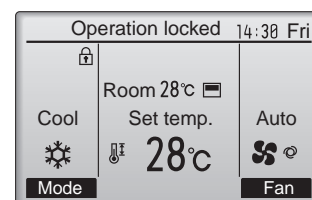

Button operation

[1]

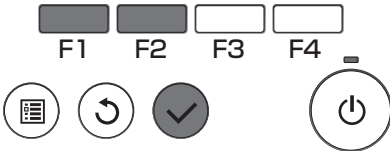
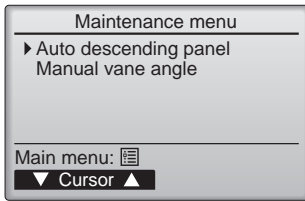

Select "Maintenance" from the Main menu (refer to page 19), and press the button.

Select "Auto descending panel" with the **F1** or **F2** button, and press the button.

* When using the auto descending panel, always set the "Address" and "Unit No." with "Service" – "Function setting".

[2]

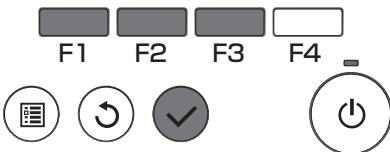
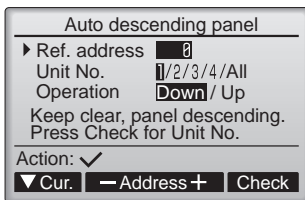

Move the cursor to "Ref. address", "Unit No." or "Operation" with the **F1** button to select.

Select the refrigerant address and the unit number for the units to whose falls panel, with the **F2** or **F3** button, and press the button.

- **Ref. address:** Refrigerant address
- **Unit No.:** 1, 2, 3, 4, All
- **Operation:** Down / Up

Press the **F4** button to confirm the unit.

<Confirmation of target unit>

If the unit being set is unknown, make the setting and then press the **F4** button to confirm.
The air conditioner which is blowing downward is the target air conditioner.

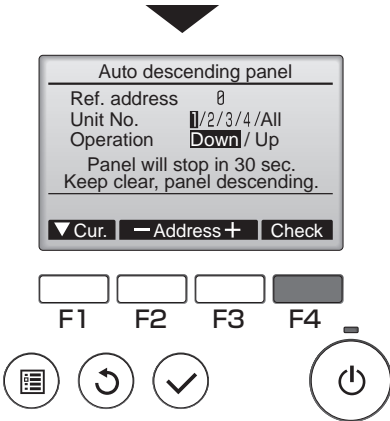

Navigating through the screens

- To return to the previous screen button

Manual vane angle



Applies to the of Ceiling cassette type.
Use to set the vane angle for each vane to a fixed position.

Button operation

[1]

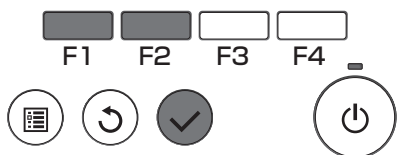
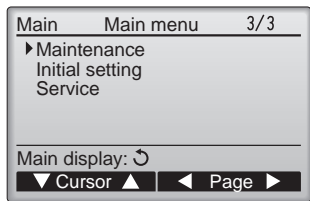

Select "Maintenance" from the Main menu (refer to page 19), and press the button.

[2]

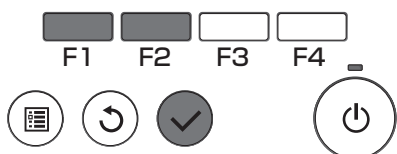
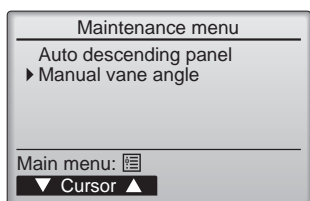

Select "Manual vane angle" with the **[F1]** or **[F2]** button, and press the button.

[3]

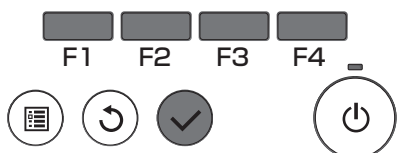
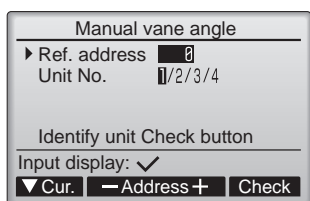

Move the cursor to "Ref. address", "Unit No." or "Operation" with the **[F1]** button to select.

Select the refrigerant address and the unit number for the units to whose vanes are to be fixed, with the **[F2]** or **[F3]** button, and press the button.

- Ref. address: Refrigerant address
- Unit No.: 1, 2, 3, 4

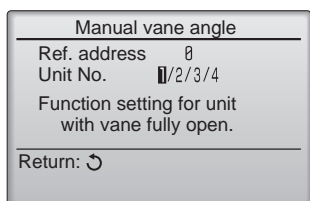

Press the **[F4]** button to confirm the unit.

Pressing the button to returns the display to [3].

<Confirmation of target unit>

If the unit being set is unknown, make the setting and then press the **[F4]** button to confirm.
The air conditioner which is blowing downward is the target air conditioner.

The screen at left shows a sample display on Mr. Slim. On City Multi units, "M-NET address," is displayed instead of "Ref. address", and the "Unit No." will not be displayed.

Maintenance

[4] [MITSUBISHI] rogo

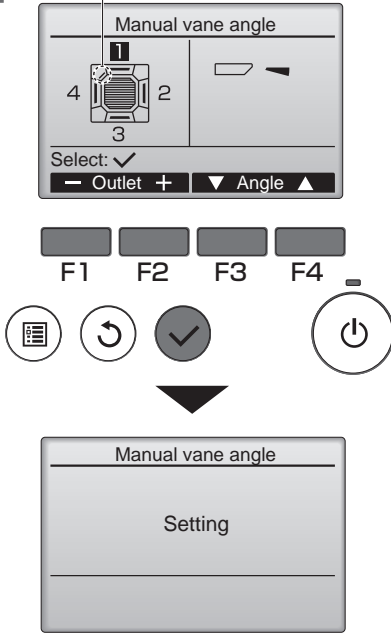

The current vane setting will appear.

Select the desired outlets from 1 through 4 with the **F1** or **F2** button.

- Outlet: "1," "2," "3," "4," and "1, 2, 3, 4, (all outlets)"



Press the **F3** or **F4** button to go through the option in the order of "No setting (reset)," "Step 1," "Step 2," "Step 3," "Step 4," and "Step 5."

Select the desired setting.

<Vane setting>

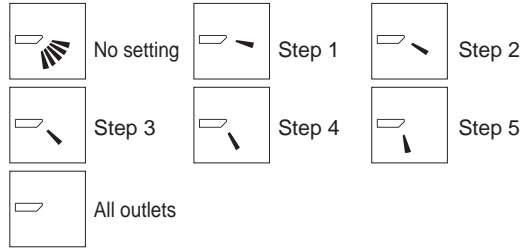

Press the button to save the settings.

A screen will appear that indicates the setting information is being transmitted. The setting changes will be made to the selected outlet. The screen will automatically return to the one shown above (step 4) when the transmission is completed. Make the settings for other outlets, following the same procedures.

If all outlets are selected, will be displayed the next time the unit goes into operation.

Navigating through the screens

- To return to the previous screen button

Initial setting

Main / Sub



When connecting two remote controllers, one of them needs to be designated as a sub controller.

Button operation

[1]

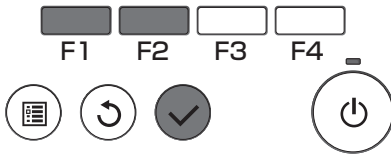
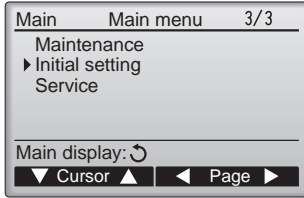

Select "Initial setting" from the Main menu (refer to page 19), and press the button.

[2]

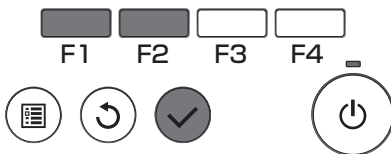
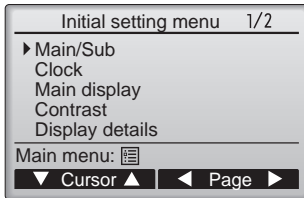

Move the cursor to the "Main / Sub" with the **F1** or **F2** button, and press the button.

[3]

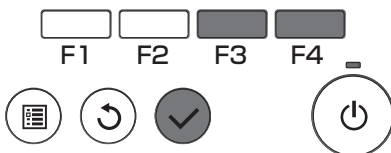
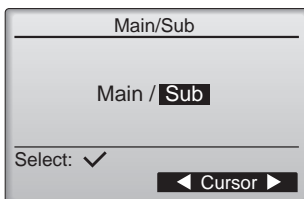

Select "Main" or "Sub" (refer to page 8) with the **F3** or **F4** button, and press the button.

If the setting is changed from "Sub remote controller" to "Main remote controller", automatically restart after changing the settings.

Navigating through the screens

- To go back to the Main menu button
- To return to the previous screen button

Button operation

[1]

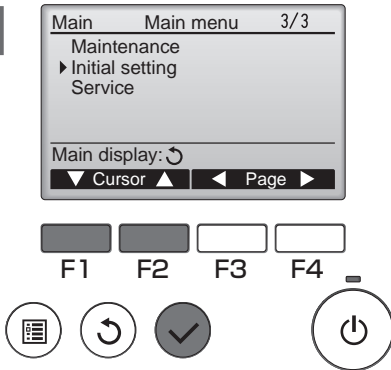

Select "Initial setting" from the Main menu (refer to page 19), and press the button.

Clock setting is required before making the following settings.

- On/Off timer
- Weekly timer
- OU silent mode
- Energy saving
- Night setback

[2]

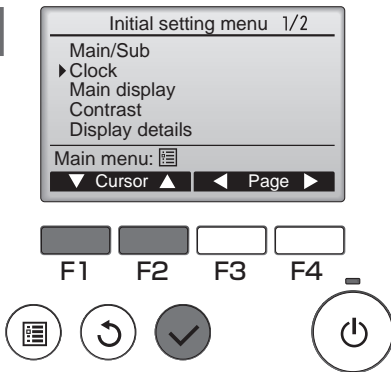

Move the cursor to the "Clock" with the **F1** or **F2** button, and press the button.

[3]

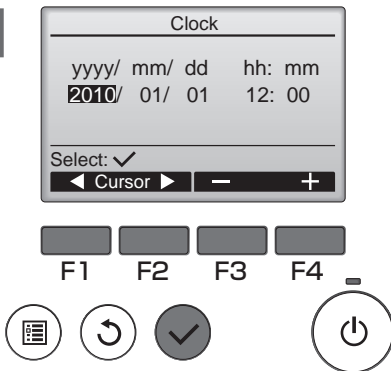

Move the cursor to the desired item with the **F1** or **F2** button out of year, month, date, hour or minute.



Increase or decrease the value for the selected item with the **F3** or **F4** button, and press the button.

A confirmation screen will appear.

Navigating through the screens

- To go back to the Main menu button
- To return to the previous screen button

Button operation

[1]

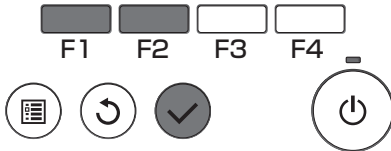
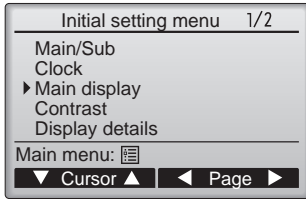

Select "Initial setting" from the Main menu (refer to page 19), and press the button.



Move the cursor to the "Main display" with the **F1** or **F2** button, and press the button.

[2]

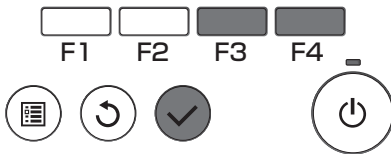
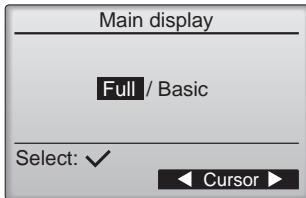

Select "Full" or "Basic" (refer to page 46) with the **F3** or **F4** button, and press the button.

A confirmation screen will appear.

Navigating through the screens

- To go back to the Main menu button
- To return to the previous screen button

Button operation

[1]

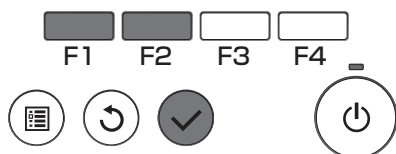
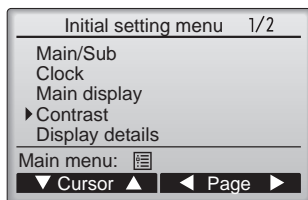

Select "Initial setting" from the Main menu (refer to page 19), and press the button.



Move the cursor to the "Contrast" with the or button, and press the button.

[2]

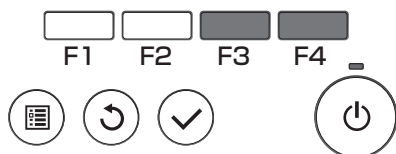
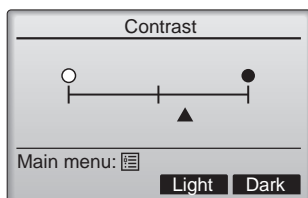

Adjust the contrast with the or button, and press the or button.

Navigating through the screens

- To go back to the Main menu button
- To return to the previous screen button

Clock

Button operation

[1]

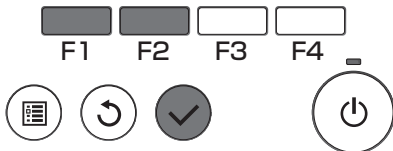
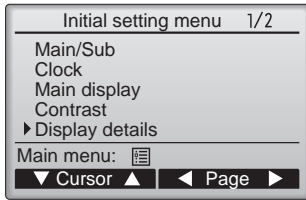

Select "Initial setting" from the Main menu (refer to page 19), and press the button.



Move the cursor to the "Display details" with the **F1** or **F2** button, and press the button.

[2]

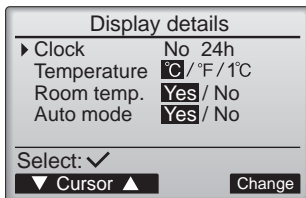

Move the cursor to the "Clock" with the **F1** or **F2** button, and change the setting with the **F4** button.

[3]

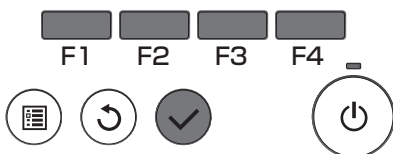
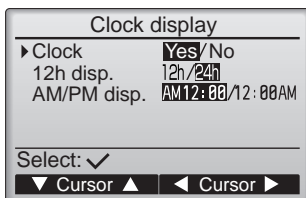

Move the cursor to the "Clock", "12 disp." or "AM / PM disp." with the **F1** or **F2** button, and change the setting with the **F3** or **F4** button.

The factory settings are "Yes" (display) and "24h" format.

- **Clock display:** Yes (Time is displayed on the Main display)
No (Time is not displayed on the Main display)
- **Display format:** 24h : 24h format
12h : 12h format
- **AM / PM display (Effective when the display format is 12-hour):**
AM / PM before the time [AM12:00]
AM / PM after the time [12:00AM]

Note: Time display format will also be reflected on the time and schedule setting display. The time is displayed as shown below.

12-hour format : AM12:00 – AM1:00 – PM12:00 – PM1:00 – PM11:59
24-hour format : 0:00 – 1:00 – 12:00 – 13:00 – 23:59



Press the button to save the settings.

Navigating through the screens

- To go back to the Main menu button
- To return to the previous screen button

Temperature Unit, Room temp, Auto mode

Button operation

[1]

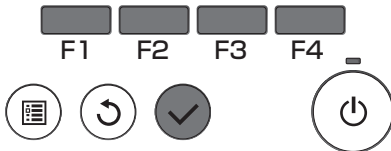
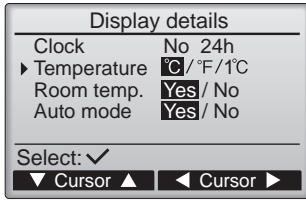

Select "Initial setting" from the Main menu (refer to page 19), and press the button.



Move the cursor to the "Display details" with the **F1** or **F2** button, and press the button.



Move the cursor to the "Temperature", "Room temp." or "Auto mode" with the **F1** or **F2** button, and change the setting with the **F3** or **F4** button.

[2]

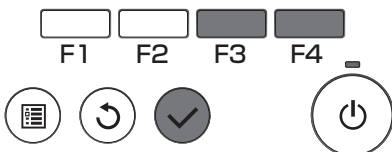
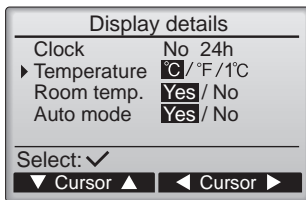

Change the setting with the **F3** or **F4** button.

- [1] Temperature unit setting (The factory default setting is Celsius (°C))
 - **°C:** Temperature is displayed in Centigrade. Temperature is displayed in 0.5- or 1-degree increments, depending on the model of indoor units.
 - **°F:** Temperature is displayed in Fahrenheit.
 - **1°C:** Temperature is displayed in Centigrade in 1-degree increments. This item will not appear on a sub remote controller.
- [2] Room temperature display (The factory default setting is "Yes")
 - **Yes:** Room temperature appears on the Main display.
 - **No:** Room temperature does not appear on the Main display.

Note: Even when "Yes" is set, the room temperature is not displayed on the Main display in the "Basic" mode.
- [3] Auto mode setting (The factory default setting is "Yes")
 - **Yes:** "AUTO COOL" or "AUTO HEAT" is displayed during operation in the AUTO (single set point) mode.
 - **No:** Only "AUTO" is displayed during operation in the AUTO (single set point) mode.



Press the button to save the settings.

Navigating through the screens

- To go back to the Main menu
- To return to the previous screen

Auto mode setting

Whether or not to use the Auto (single set point) or Auto (dual set points) mode can be selected by using the button. This setting is valid only when indoor units with the AUTO mode function are connected.

Button operation

[1]

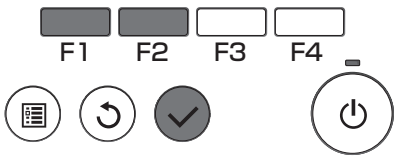
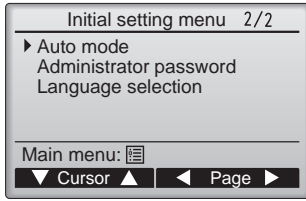

Select "Initial setting" from the Main menu (refer to page 19), and press the button.



Move the cursor to the "Auto mode" with the **F1** or **F2** button, and press the button.

[2]

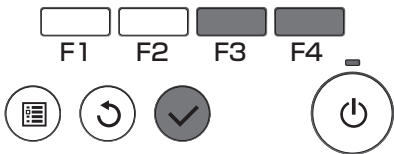
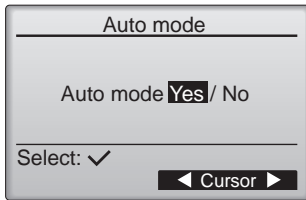

Change the setting with the **F3** or **F4** button.



Press the button to save the changes mode.

Auto mode setting : The factory default setting is "Yes".

- **Yes:** The AUTO mode can be selected in the operation mode setting.
- **No:** The AUTO mode cannot be selected in the operation mode setting.

Navigating through the screens

- To go back to the Main menu
- To return to the previous screen

Administrator password setting



The administrator password is required to make the settings for the following items.

- Timer setting • Energy-save setting • Weekly timer setting • Restriction setting
- Outdoor unit silent mode setting • Night set back

Button operation

[1]

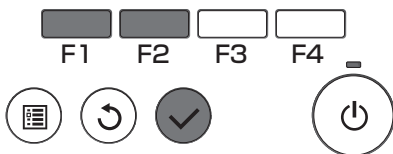
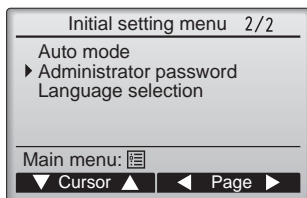

Select "Initial setting" from the Main menu (refer to page 19), and press the button.

Move the cursor to the "Administrator password" with the **F1** or **F2** button, and press the button.

[2]

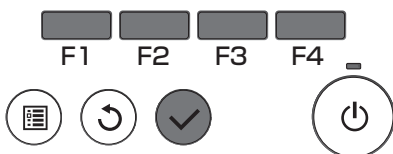
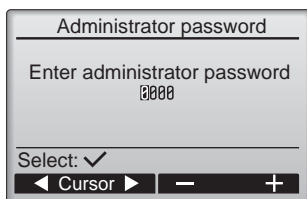

To enter the current Administrator password (4 numerical digits), move the cursor to the digit you want to change with the **F1** or **F2** button.

Set each number(0 through 9) with the **F3** or **F4** button.

Press the button.

Note: The initial administrator password is "0000". Change the default password as necessary to prevent unauthorized access. Have the password available for those who need it.

: If you forget your administrator password, you can initialize the password to the default password "0000" by pressing and holding the **F1** and **F2** buttons simultaneously for three seconds on the administrator password setting screen.

[3]

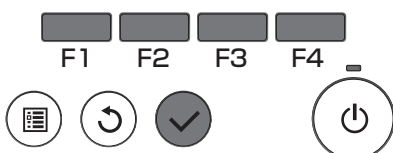
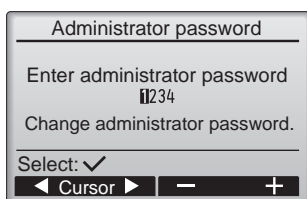

If the password matches, a window to enter a new password will appear.

Enter a new password in the same way as explained above, and press the button.

[4]

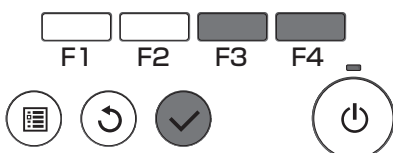
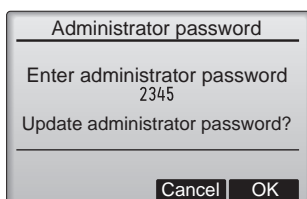

Press the **F4** button (OK) on the password change confirmation screen to save the change.

Press the **F3** button (Cancel) to cancel the change.

Note: The administrator password is required to make the settings for the following items.

- Timer setting • Weekly timer setting • Energy-save setting
- Outdoor unit silent mode setting • Restriction setting

Refer to the Instruction Book that came with the remote controller for the detailed information about how to make the settings for these items.

Language selection



The desired language can be set. The language options are English, French, German, Spanish, Italian, Portuguese, Swedish, and Russian.

Button operation

[1]

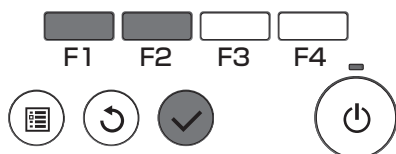
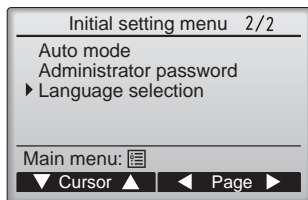

Select "Initial setting" from the Main menu (refer to page 19), and press the button.



Move the cursor to the "Language selection" with the **F1** or **F2** button, and press the button.

[2]

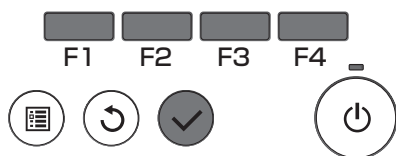
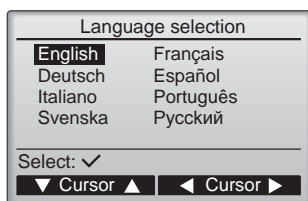

Move the cursor to the language you desire with the **F1** through **F4** buttons, and press the button to save the setting.

When the power is on for the first time, the Language selection screen will be displayed. Select a desired language. The system will not start-up without language selection.



A screen will appear that indicates the setting has been saved.

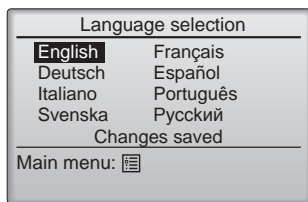

Navigating through the screens

- To go back to the Main menu button
- To return to the previous screen button

Initial setting

Maintenance password is required

Button operation

[1]

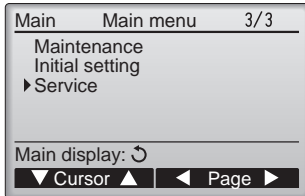

Select "Service" from the Main menu (refer to page 19), and press the button.

*At the main display, the menu button and select "Service" to make the maintenance setting.

[2]

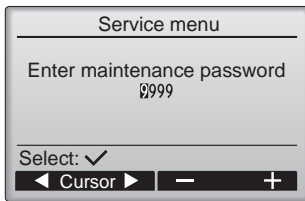

When the Service menu is selected, a window will appear asking for the password.

To enter the current maintenance password (4 numerical digits), move the cursor to the digit you want to change with the **F1** or **F2** button.

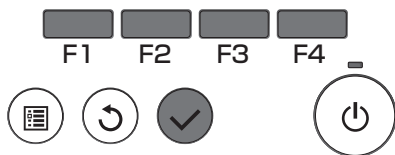

Set each number (0 through 9) with the **F3** or **F4** button.

Then, press the button.

Note: The initial maintenance password is "9999". Change the default password as necessary to prevent unauthorized access. Have the password available for those who need it.

: If you forget your maintenance password, you can initialize the password to the default password "9999" by pressing and holding the **F1** and **F2** buttons simultaneously for three seconds on the maintenance password setting screen.

[3]

<For Mr.Slim>

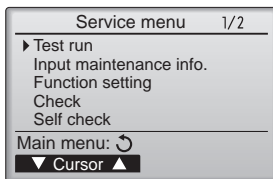

<For City Multi>

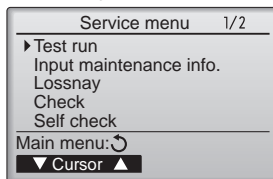

If the password matches, the Service menu will appear.

The type of menu that appears depends on the connected indoor units' type (City Multi or Mr. Slim).

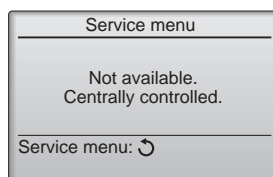
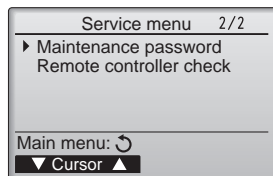
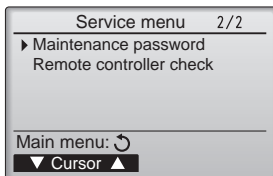

Note: Air conditioning units may need to be stopped to make certain settings. There may be some settings that cannot be made when the system is centrally controlled.

A screen will appear that indicates the setting has been saved.

Navigating through the screens

- To go back to the Main menu button
- To return to the previous screen button

Refer to the indoor unit Installation Manual for how to make the settings.

Button operation

[1]

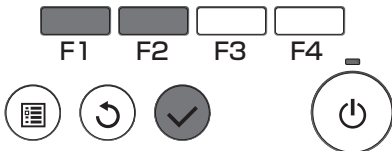
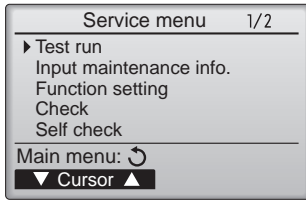

Select "Service" from the Main menu (refer to page 19), and press the button.

Select "Test run" with the **F1** or **F2** button, and press the button.

[2]

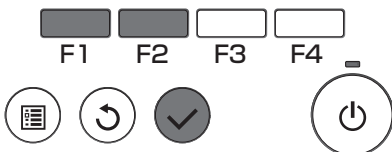
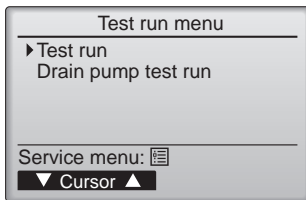

Select "Test run" with the **F1** or **F2** button, and press the button.

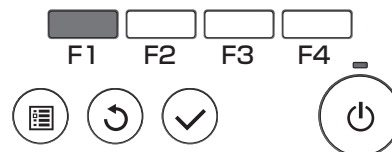
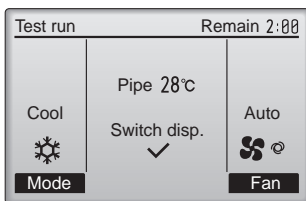

Test run operation

Press the **F1** button to go through the operation modes in the order of "Cool and Heat".

Cool mode: Check the cold air blow off.
Heat mode: Check the heat blow off.

Press the button and open the Vane setting screen.

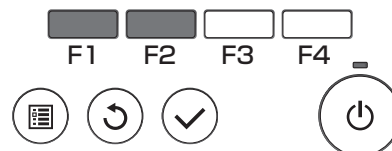
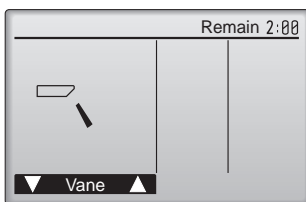

Auto vane check

Check the auto vane with the **F1** **F2** buttons.
* Check the operation of the outdoor unit's fan.

Press the button to return to "Test run operation".

Press the button.

When the test run is completed, the "Test run menu" screen will appear.
* The test run will automatically stop after two hours.

Drain pump test run



It is possible to run just the drain pump without running the indoor unit's fan.

Carry this out after completing the indoor and outdoor electrical work.

* Refer to the indoor unit's installation manual, and confirm that the water is accurately drained, and that no water is leaking from the pipe connections.

Button operation

[1]

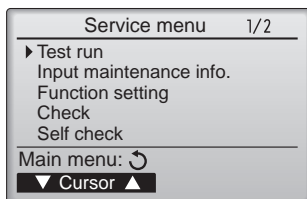

Select "Service" from the Main menu (refer to page 19, and press the button.



Select "Test run" with the **F1** or **F2** button, and press the button.

[2]

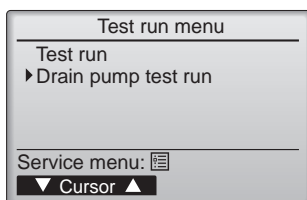

Select "Drain pump test run" with the **F1** or **F2** button, and press the button.

[3]

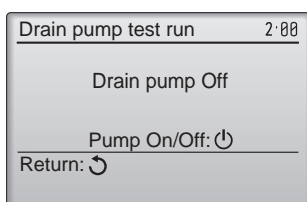

Start the drain pump test run.

Press the button.

* The drain pump will be prepared for the "Drain pump test run", and the test run will start.

[4]

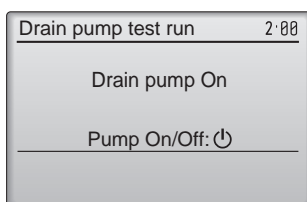

Check the drain pump's operation state.

End the drain pump test run.

Press the button.

The drain pump test run will be finished, and then the "Test run menu" screen will appear.

* The drain pump test run will automatically stop after two hours.

Input maintenance info.



Select "Input maintenance info." from the Service menu to bring up the Maintenance information screen. Refer to the indoor unit Installation Manual for how to make the settings.

Button operation

[1]

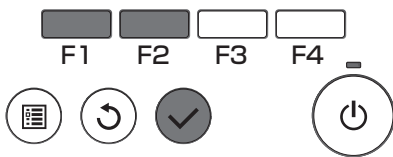
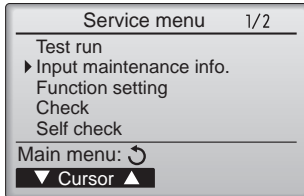

Select "Service" from the Main menu (refer to page 19), and press the button.



Select "Input maintenance info." with the **F1** or **F2** button, and press the button.

Model name input

[2]

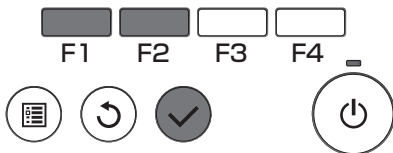
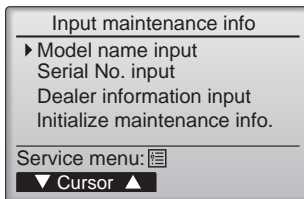

Select "Model name input" with the **F1** or **F2** button, and press the button.

Service

[3]

<For Mr.Slim>

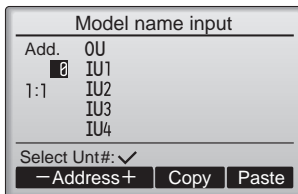

<For City Multi>

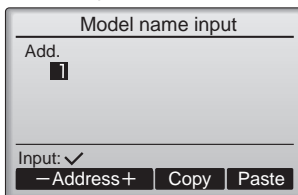

Select the Ref. address, Outdoor unit and Indoor unit to be registered.

Select the Ref address/M-NET address to be registered with the **F1** and **F2** buttons.

<For Mr.Slim>
"Refrigerant address" setting [0] to [15]
<For City Multi>
"M-NET address" setting [1] to [255]
*Only a connected address can be selected.



Press the button.

The registered model information can be copied and pasted into the refrigerant address/M-NET address units.

- **F3** button: Copies the model information for the selected address.
- **F4** button: Overwrites the copied model information onto the selected address.

[4]

<For Mr.Slim>

Model information	
Add.	OU PUHZ-RP71VHA4
	IU1 PLA-RP71BA2
1:1	IU2
	IU3
	IU4
Select: ✓	
▼ Cursor ▲ ▼ Letter ▲	

<For City Multi>

Model information	
Add.	PLFY-P63VBM-E8
Select: ✓	
▼ Cursor ▲ ▼ Letter ▲	

Cursor
The highlighted characters are selected.

Model name input.

Select the unit to be registered with the **[F1]** and **[F2]** buttons.

<For Mr.Slim>

- Setting the "Registered unit" [OU] / [IU1] to [IU4]
 - OU: Outdoor unit
 - IU1: Indoor unit No. 1
 - IU2: Indoor unit No. 2
 - IU3: Indoor unit No. 3
 - IU4: Indoor unit No. 4
- * IU2 to IU4 may not appear depending on the type of connected air conditioner (single, twin, triple, quadruple).

Move the input cursor to the left and right with the **[F1]** and **[F2]** buttons, and select the letters with the **[F3]** and **[F4]** buttons.

■ Input letters
Select from: A, B, C, D ... Z, 0, 1 2 ... 9, -, space
*Model names can be input up to 18 letters.

Press the **⏏** button.

- Repeat the above step, and register the model names for the outdoor unit and indoor unit of the selected refrigerant address and M-NET address.
- Changing the refrigerant address and M-NET address
After the model name is registered above, press the **⏏** button. The "3" screen will appear. Change the refrigerant address and M-NET address, and using the previous procedure input the Model name.

Serial No. input

[5]

<For Mr.Slim>

Serial No. information	
Add.	OU
	IU1
1:1	IU2
	IU3
	IU4
Select Unt#: ✓	
-Address+ Copy Paste	

<For City Multi>

Serial No. information	
Add.	07A01232
Select: ✓	
-Address+ Copy Paste	

Select "Serial No. input" on the Maintenance information screen, and press the **⏏** button.

Register the Serial No. with the procedure given in [3] [4].
*Serial No. can be input up to 8 letters.

Dealer information input

[6]

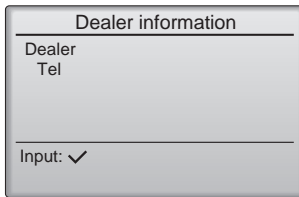

Select "Dealer information input" on the Maintenance information, and press the  button.



The current settings will appear. Then press the  button again.



Move the input cursor to the left and right with the **F1** and **F2** buttons, and select the letters with **F3** and **F4** buttons.

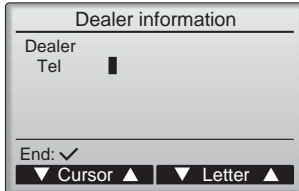

Input letters

Select from : 0 , 1 , 2 , ... , 9 , - , space

*Dealer information can be input up to 13 letters.



Press the  button.

Initialize maintenance info.

[7]

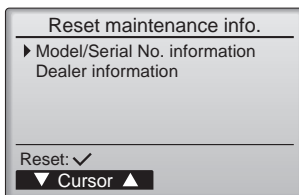

Model/Serial No. information reset.

Select "Initialize maintenance info." on the Maintenance information, and press the  button.



Select "Model/Serial No. information" and press the  button.



A confirmation screen will appear asking if you want to reset the Model/Serial No. information.



Press the **F4** button (OK) to reset the Model/Serial No information.

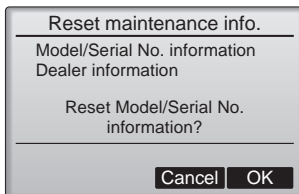

[8]

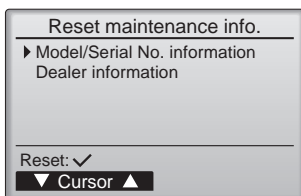

Dealer information reset.

Select "Initialize maintenance info." on the Maintenance information, and press the  button.



Select "Dealer information" and press the  button.



A confirmation screen will appear asking if you want to reset the Dealer information.



Press the  button (OK) to reset the Dealer information.

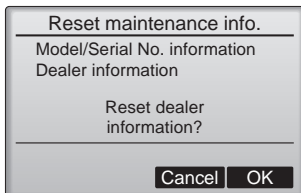

Button operation

[1]

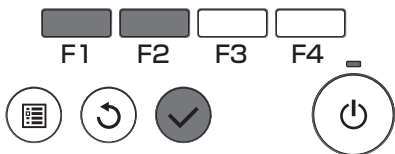
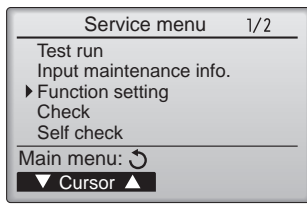

Select "Service" from the Main menu (refer to page 19), and press the button.



Select "Function setting" with the **F1** or **F2** button, and press the button.

[2]

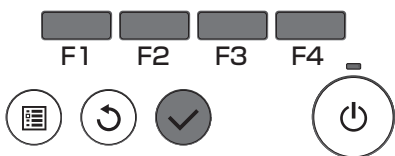
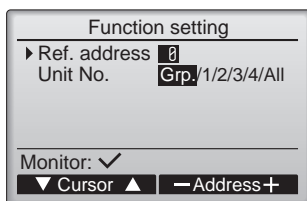

Set the indoor unit refrigerant addresses and unit numbers with the **F1** through **F4** buttons, and then press the button to confirm the current setting.

<Checking the indoor unit No.>

When the button is pressed, the target indoor unit will start fan operation. If the unit is common or when running all units, all indoor units for the selected refrigerant address will start fan operation.

[3]

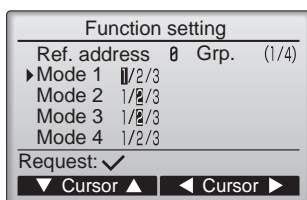

When data collection from the indoor units is completed, the current settings appears highlighted. Non-highlighted items indicate that no function settings are made. Screen appearance varies depending on the "Unit No." setting.

[4]

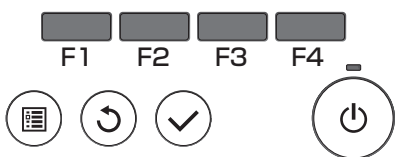
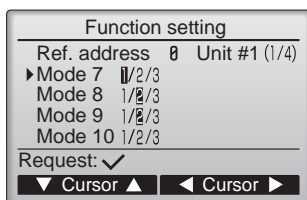

Use the **F1** or **F2** button to move the cursor to select the mode number, and change the setting number with the **F3** or **F4** button.

Individual items
 (Unit No.1 through 4)

[5]

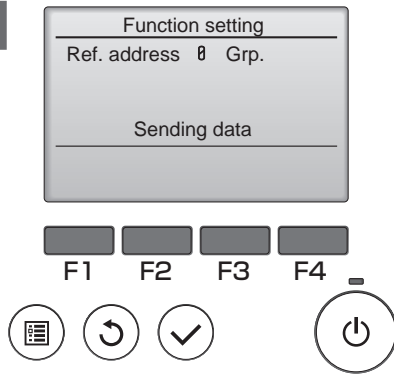

When the settings are completed, press the button to send the setting data from the remote controller to the indoor units.

When the transmission is successfully completed, the screen will return to the Function setting screen.

- note:**
- Make the above settings only on Mr. Slim units as necessary.
 - The above function settings are not available for the City Multi units.
 - Table 1, 2 summarizes the setting options for each mode number. Refer to the indoor unit Installation Manual for the detailed information about initial settings, mode numbers, and setting numbers for the indoor units.
 - Be sure to write down the settings for all functions if any of the initial settings has been changed after the completion of installation work.

<Table1> Function setting options

Mode No.	Mode	Settings	Setting No.	Unit numbers
01	Automatic recovery after power failure	Disable	1	Set "Grp." for the Unit number. These settings apply to all the connected indoor units.
		Enable (Four minutes of standby time is required after the restoration of power.)	2	
02	Thermistor selection (indoor temperature detection)	Average temperature reading of the indoor units in operation	1	
		Thermistor on the indoor unit to which the remote controller is connected (fixed)	2	
		Built-in sensor on the remote controller	3	
03	LOSSNAY connection	Not connected	1	
		Connected (without outdoor air intake by the indoor units)	2	
		Connected (with outdoor air intake by the indoor units)	3	
04	Power voltage	240 V	1	
		220 V, 230 V	2	
06	Auto operation mode	Single set point	1	
		Dual set point	2	

Other function selections

<Table 2>

Function	Settings	Mode No.	Setting No.	Initial setting (Factory setting) –:Not available								
				4-WAY cassette		Ceiling suspended		Wall mounted	Ceiling concealed			Floor standing
				PLA-(Z)RP-BA(2)	SLZ-KA-VAL/VAQ	PCA-RP-KAQ	PCA-RP-HAQ	PKA-RP-HAL/KAL	PEAD-RP-JA(L)Q	PEA-RP-GAQ	SEZ-KD-VAL/VAQ	PSA-RP-KA
Filter sign	100Hr	07	1				●	●				
	2500Hr		2	●	●	●						●
	No filter sign indicator		3						●	●	●	
Air flow (Fan speed)	Quiet	08	1		–		–		Extra static pressure setting * refer to Table 3			
	Standard		2	●	–	●	–	●				●
	High ceiling		3		–		–					–
No. of air outlets	4 directions	09	1	●	–	–	–	–	–	–	–	–
	3 directions		2		–	–	–	–	–	–	–	–
	2 directions		3		–	–	–	–	–	–	–	–
Installed options (high performance filter)	Not supported	10	1	●	–	●	–	–	Extra static pressure setting * refer to Table 3			–
	Supported		2		–	–	–	–				–
Horizontal vane setting	No vanes (Vane No.3 setting: PLA only)	11	1		–		–	–	–	–	–	–
	Vane No.1 setting		2		–	●	–	–	–	–	–	–
	Vane No.2 setting		3	●	–		–	–	–	–	–	–
I-see sensor mounting position	Mounting position ①	12	1		–	–	–	–	–	–	–	–
	Mounting position ②		2		–	–	–	–	–	–	–	–
	Standard		3	●	–	–	–	–	–	–	–	–
Vane differential setting in heating mode (cold wind prevention)	Low (24°C – 28°C)	14	1				–		–	–	–	–
	Standard (28°C – 32°C)		2	●	●	●	–	●	–	–	–	–
	High (35°C – 38°C)		3				–		–	–	–	–
Swing	Not supported	23	1	–			–		–	–	–	–
	Supported		2	–	●	●	–	●	–	–	–	–
Wave Airflow	Swing	24	1		–	–	–	–	–	–	–	–
	Wave airflow		2	●	–	–	–	–	–	–	–	–
Set temperature in heating (4 deg-up) *1 PKA: 2 deg-up	Available	24	1	●	●	●	●	● ^{*1}	●	●	●	
	Not available		2									●
Fan speed during the heating thermostat is OFF	Extra low	25	1	●	●	●	●	●	●	●	●	●
	Stop		2									
	Setting fan speed		3								●	
Fan speed during the cooling thermostat is OFF	Setting fan speed	27	1	●	●	●	●	●	●	●	●	●
	Stop		2									
Detection of abnormality of the pipe temperature (P8)	Available	28	1	●	●	●	●	●	●	●	●	●
	Not available		2									

<Table 3>

External static pressure	Setting no. of		PEAD, PEA	SEZ	Mode No.	Setting No.	Initial setting (Factory setting) –:Not available								
	Mode no.08	Mode no.10					4-WAY cassette		Ceiling suspended		Wall mounted	Ceiling concealed			Floor standing
	1	2	35 Pa	50 Pa			PLA-(Z)RP-BA(2)	SLZ-KA-VAL/VAQ	PCA-RP-KAQ	PCA-RP-HAQ	PKA-RP-HAL/KAL	PEAD-RP-JA(L)Q	PEA-RP-GAQ	SEZ-KD-VAL/VAQ	PSA-RP-KA
External static pressure	1	1	–	15 Pa	08	1	–	–	–	–	–			●	–
			35 Pa	50 Pa		2	–	–	–	–	–			–	
			50 Pa	50 Pa		3	–	–	–	–	–	●	●		–
	2	2	70 Pa	5 Pa	10	1	–	–	–	–	–	●	●	●	–
			100 Pa	–		2	–	–	–	–	–	–	–	–	
			125 Pa	–		3	–	–	–	–	–	–	–	–	

Meaning of "Function setting"

Mode02 : indoor temperature detecting

No	indoor temperature (ta)					
No.1	Average data of the sensor on all the indoor units	Initial setting	$ta = (A+B) / 2$	$ta = (A+B) / 2$	$ta = A$	$ta = A$
No.2	The data of the sensor on the indoor unit that connected with remote controller		$ta = A$	$ta = B$	$ta = A$	$ta = A$
No.3	The data of the sensor on main remote controller.		$ta = C$	$ta = C$	$ta = C$	$ta = C$

*Can be set only when a wired remote controller is used. This function cannot be set for floor type models. When using 2 remote controllers (two-remote controller operation), the remote controller with built-in sensor must be set as a main remote controller.

Supplementary Information (Unit Function Setting)

(For setting, refer to OUTDOOR UNIT'S SERVICE MANUAL.)

1) Vane setting (Function setting mode11)

Model	Setting No.	● : Initial setting	Setting
PLA-(Z)RP(2)	1		Downward position than the standard (less smudging setting)
	2		Standard position
	3	●	Upward position than the standard (less draft setting) *
PCA-KAQ	1		No vane function
	2	●	Standard position
	3		Upward position than the standard (less draft setting) *

*Be careful of the smudge on ceiling.

2) Vane differential setting in heating mode (cold wind prevention) (Function setting mode14)

When piping temperature (TH5) becomes low during heating operation, the up / down vane is set to horizontal direction for less draft setting.

In this vane differential setting, the conditions of piping temperature to change airflow setting of horizontal and setting shown below can be adjusted finely.

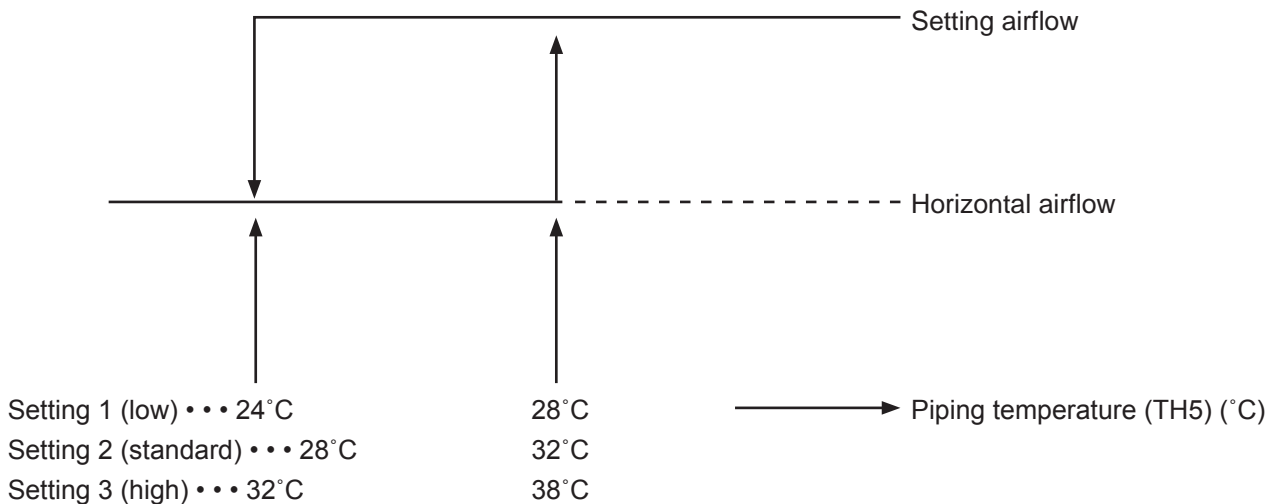

Function setting (City Multi)



Make the indoor units' function settings from the remote controller as necessary.

- The following settings should be made only for City Multi units and as necessary.
- Refer to the Installation Manual for how to make the settings for Mr. Slim units.
- Refer to the indoor unit Installation Manual for information about the factory settings of indoor units, function setting numbers, and setting values.
- When changing the indoor units' function settings, record all the changes made to keep track of the settings.

Button operation

[1]

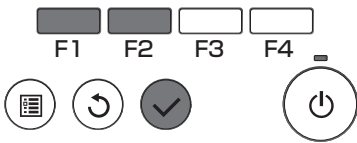
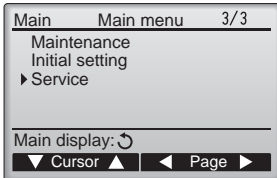

Select "Service" from the Main menu (refer to page 19), and press the button.



Select "Function setting" with the **F1** or **F2** button, and press the button.

[2]

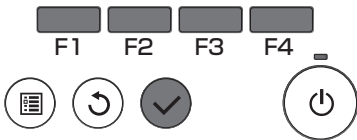
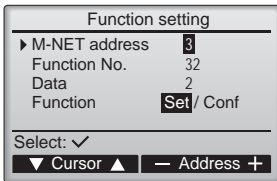

The Function Setting screen will appear.

Press the **F1** or **F2** button to move the cursor to one of the following: M-NET address, function setting number, or setting value.



Then, press the **F3** or **F4** button to change the settings to the desired settings.



Once the settings have been completed, press the button.

A screen will appear that indicates that the settings information is being sent.

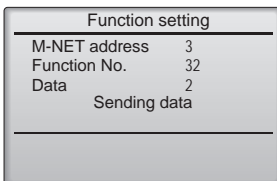

To check the current settings of a given unit, enter the setting for its M-NET address and function setting number, select Conf for the Function, and press the button.

A screen will appear that indicates that the settings are being searched for. When the search is done, the current settings will appear.



[3]

Function setting	
M-NET address	3
Function No.	32
Data	2
Setting completed	
Return:	↶

When the settings information has been sent, a screen will appear that indicates its completion.

To make additional settings, press the  button to return to the screen shown in Step 3 above. Set the function numbers for other indoor units by following the same steps.

Navigating through the screens

- To return to the Service Menu screen  button
- To return to the previous screen  button

LOSSNAY setting



This setting is required only when the operation of City Multi units is interlocked with LOSSNAY units. This setting is not available for the Mr. Slim units. Interlock settings can be made for the indoor unit to which the remote controller is connected. (They can also be confirmed or deleted.)

- note: • Use the centralized controller to make the settings if it is connected.
- To interlock the operation of the indoor units with the LOSSNAY units, be sure to interlock the addresses of ALL indoor units in the group and that of the LOSSNAY unit.

Button operation

[1]

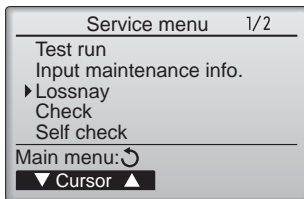

Select "Service" from the Main menu (refer to page 19), and press the button.



Select "Lossnay" with the or button, and press the button.

[2]

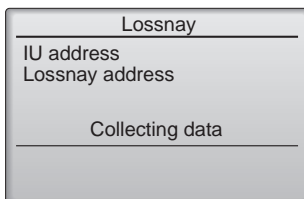

When "Lossnay" on the Service menu is selected, the remote controller will automatically begin searching for the registered LOSSNAY addresses of the currently connected indoor unit.

[3]

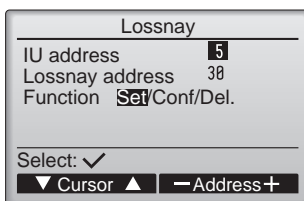

When the search is completed, the smallest address of the indoor units that are connected to the remote controller and the address of the interlocked LOSSNAY unit will appear. "--" will appear if no LOSSNAY unit is interlocked with the indoor units.

If no settings need to be made, press the button to go back to the Service menu.

[4]

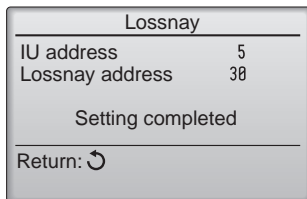
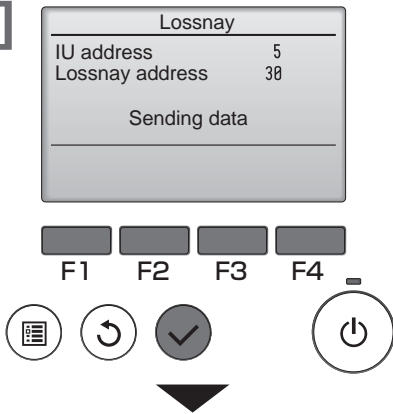

To make LOSSNAY interlock setting

Enter the addresses of the indoor unit and the LOSSNAY unit to be interlocked, with the [F1] through [F4] buttons, select "Set" in the "Function", and press the (✓) button to save the settings.

"Sending data" will appear on the screen. If the setting is successfully completed, "Setting completed" will appear.

[5]

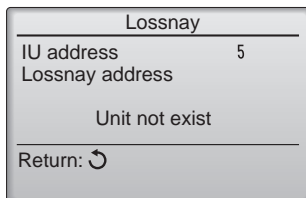
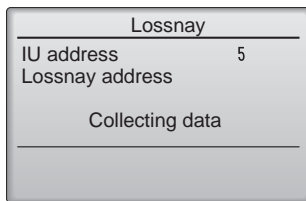

To search for the LOSSNAY address

Enter the address of the indoor unit to which the remote controller is connected, select "Conf" in the "Function", and press the (✓) button.

"Collecting data" will appear on the screen. If the signal is received correctly, the indoor unit address and LOSSNAY address will appear. "--" will appear when no LOSSNAY unit is found. "Unit not exist" will appear if no indoor units that are correspond to the entered address are found.

[6]

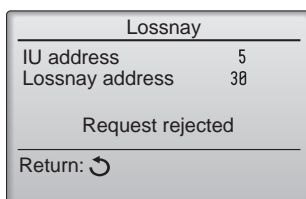
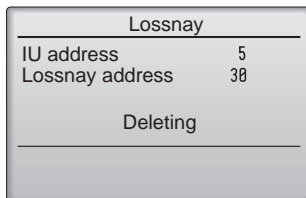

To delete the interlock setting

To delete the interlocked setting between LOSSNAY unit and the indoor units to which the remote controller is connected, enter the indoor unit address and LOSSNAY address with the [F1] through [F4] buttons, select "Del." in the "Function", and press the (✓) button. "Deleting" will appear.

The screen will return to the search result screen if the deletion is successfully completed. "Unit not exist" will appear if no indoor units that are correspond to the entered address are found. If deletion fails, "Request rejected" will appear on the screen.

Error history

Button operation

[1]

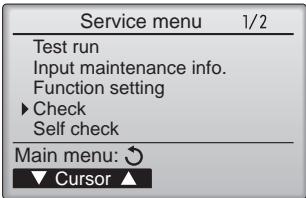

Service menu 1/2

- Test run
- Input maintenance info.
- Function setting
- ▶ Check
- Self check

Main menu: ↻

▼ Cursor ▲

Select "Service" from the Main menu (refer to page 19), and press the

▼

Select "Check" with the **F1** or **F2** button, and press the .

☰

↻

✔

⏻

[2]

<For Mr.Slim>

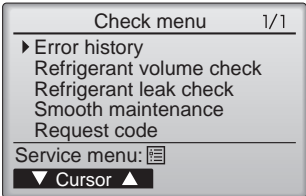

Check menu 1/1

- ▶ Error history
- Refrigerant volume check
- Refrigerant leak check
- Smooth maintenance
- Request code

Service menu: ☰

▼ Cursor ▲

<For City Multi>

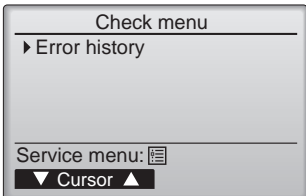

Check menu

- ▶ Error history

Service menu: ☰

▼ Cursor ▲

Select "Error history" with the **F1** or **F2** button, and press the .

[3]

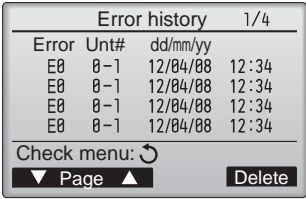

Error history 1/4

Error	Unt#	dd/mm/yy	Time
E0	0-1	12/04/08	12:34
E0	0-1	12/04/08	12:34
E0	0-1	12/04/08	12:34
E0	0-1	12/04/08	12:34

Check menu: ↻

▼ Page ▲ Delete

Error history

Select "Error history" from the Check menu, and press the button to view up to 16 error history records.

Four records are shown per page, and the top record on the first page indicates the latest error record.

☰

↻

✔

⏻

[4]

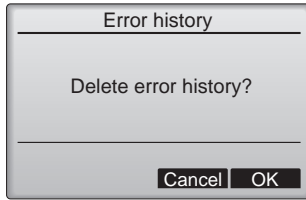

Error history

Delete error history?

Cancel OK

▼

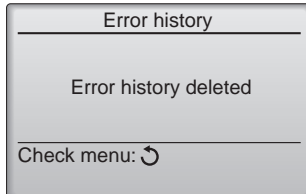

Error history

Error history deleted

Check menu: ↻

Deleting the error history

To delete the error history, press the **F4** button (Delete) on the screen that shows error history.

A confirmation screen will appear asking if you want to delete the error history.

▼

Press the **F4** button (OK) to delete the history.

▼

"Error history deleted" will appear on the screen.

Press the button to go back to the Check menu screen.

Refrigerant leak check

Refrigerant leakage is detected after a long time.

To enable this function, the refrigerant volume must be saved (initial learning) after installation. Always operate this function in the following manner after installation.

- Always perform test run before using this function, and confirm that the air conditioner operates normally.
- To accurately detect refrigerant leaks, set the wind speed to strong, and execute this operation.

* "Refrigerant leak check" is valid only with models which support the refrigerant leak check function.

Button operation

[1]

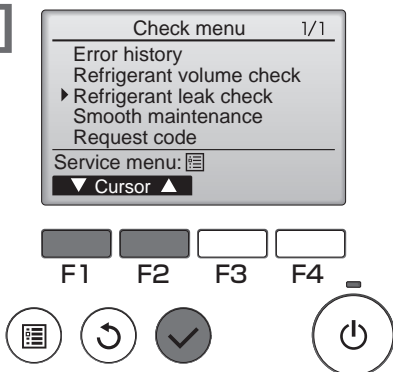

Select "Service" from the Main menu (refer to page 19), and press the  button.

Select "Check" with the **F1** or **F2** button, and press the  button.

Select "Refrigerant leak check" with the **F1** or **F2** button, and press the  button.

[2]

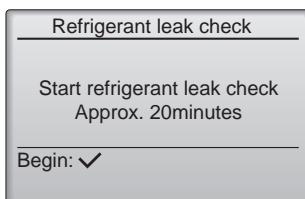

Stable mode will start.

Press the  button, stable mode will start.

*Stable mode will take approx. 20 minutes.

[3]

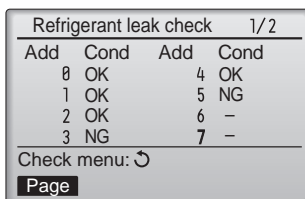

The operation data will appear.

The following value is the reference for the refrigerant volume check. If the refrigerant is leaking, "NG" will appear.

The refrigerant volume check reference value can be changed with the function selection.

Default value (Z)RP71 - : 80%
- (Z)RP50 : 70%

<Resetting the initial learning data>

If the unit has been relocated or if refrigerant has been additionally charged, the initial learning data must be reset and learning performed again.

How to reset the data:

1. Turn the main power OFF.
2. Attach the short-circuit pin for the emergency operation connector (CN31) on the outdoor controller board to the ON side.
3. Turn ON the test run switch (SW4-1) on the outdoor controller board.
4. The data will be reset when the main power is turned ON.
5. Turn the main power OFF.
6. Turn OFF the test run switch (SW4-1).
7. Return the short-circuit pin for the emergency operation connector (CN31) to the OFF side.

* Under the following conditions, it may not be possible to carry out stable operation or accurately detect refrigerant leaks.

- When the outdoor intake temperature is 40°C or higher, or when the indoor intake temperature is 23°C or less.
- When the indoor fan speed is not set to strong.

Check

Smooth maintenance

Maintenance data, such as the indoor/outdoor unit's heat exchanger temperature and compressor operation current can be displayed with "Smooth maintenance".

* This cannot be executed during test operation.

* Depending on the combination with the outdoor unit, this may not be supported by some models.

Button operation

[1]

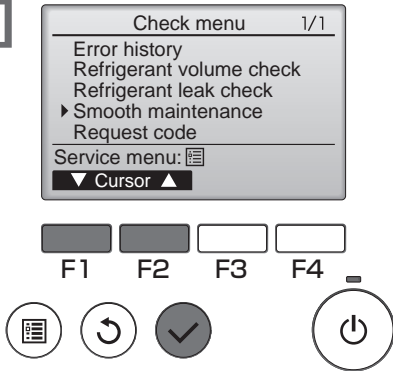

Select "Service" from the Main menu (refer to page 19), and press the button.

Select "Check" with the **[F1]** or **[F2]** button, and press the button.

Select "Smooth maintenance" with the **[F1]** or **[F2]** button, and press the button.

[2]

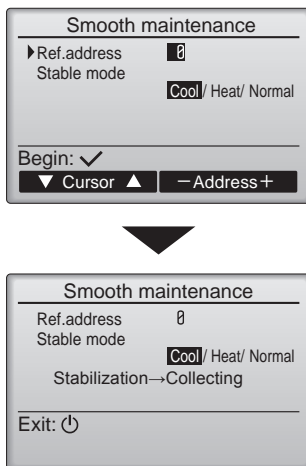

Set each item.

Select the item to be changed with the **[F1]** or **[F2]** button.

Select the required setting with the **[F3]** or **[F4]** button.

- <Ref.address>setting [0]~[15]
- <Stable mode>setting [Cool] / [Heat] / [Normal]

Press the button, Fixed operation will start.

* Stable mode will take approx. 20 minutes.

[3]

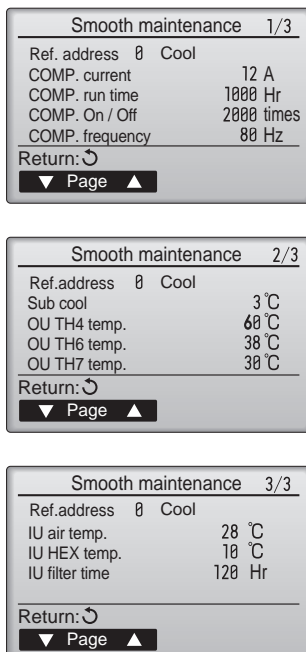

The operation data will appear.

The Compressor-Accumulated operating (COMP. run) time is 10-hour unit, and the Compressor-Number of operation times (COMP. On / Off) is a 100-time unit (fractions discarded).

Navigating through the screens

- To go back to the Main menu button
- To return to the previous screen button

Check

Request code

Details on the operation data including each thermistor temperature and error history can be confirmed with the remote controller.

Button operation

[1]

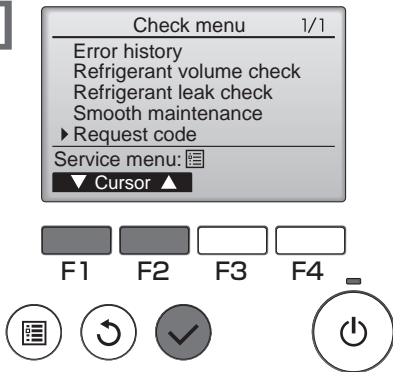

Select "Service" from the Main menu (refer to page 19), and press the button.

Select "Check" with the **F1** or **F2** button, and press the button.

Select "Request code" with the **F1** or **F2** button, and press the button.

[2]

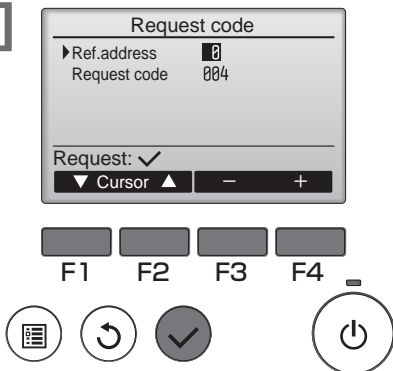

Set the Refrigerant address and Request code.

Select the item to be changed with the **F1** or **F2** button.

Select the required setting with the **F3** or **F4** button.

- <Ref.address>setting [0] – [15]
- <Request code>setting [Refer to next page]

Press the button, Data will be collected and displayed.

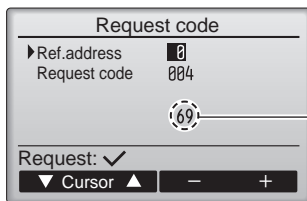

Request code: 004
Discharge temperature: 69°C

<Operation state> (Request code "0")

Data display



Operation mode

Relay output state

1) Operation mode

Display	Operation mode
0	STOP • FAN
C	COOL • DRY
H	HEAT
d	Defrost

2) Relay output state

Display	Power currently supplied to compressor	Compressor	Four-way valve	Solenoid valve
0	—	—	—	—
1				ON
2			ON	
3			ON	ON
4		ON		
5		ON		ON
6		ON	ON	
7		ON	ON	ON
8	ON			
A	ON		ON	

<Request Cord list>

* The Request code 150 – 152 data is the information for the indoor unit to which the remote controller is connected.

Request code	Request content	Description (Display range)	Unit	Remarks
0	Operation state	Refer to "Operation mode"	–	
1	Compressor - Operating current (rms)	0 – 50	A	
2	Compressor - Accumulated operating time	0 – 9999	10 hours	
3	Compressor - Number of operation times	0 – 9999	100 times	
4	Discharge temperature (TH4)	3 – 217	°C	
5	Outdoor unit - Liquid pipe 1 temperature (TH3)	-40 – 90	°C	
7	Outdoor unit - 2 phase pipe temperature (TH6)	-39 – 88	°C	
9	Outdoor unit - Outside air temperature (TH7)	-39 – 88	°C	
10	Outdoor unit - Heatsink temperature (TH8)	-40 – 200	°C	
12	Discharge superheat (SHd)	0 – 255	°C	
13	Sub - cool (SC)	0 – 130	°C	
16	Compressor - Operating frequency	0 – 255	Hz	
18	Outdoor unit - Fan output step	0 – 10	Step	
22	LEV (A) opening	0 – 500	Pulses	
30	Indoor unit - Setting temperature	17 – 30	°C	
31	Indoor unit - Intake air temperature <Measured by thermostat>	8 – 39	°C	
37	Indoor unit - Liquid pipe temperature (Unit No.1)	-39 – 88	°C	"0" is displayed if the target unit is not present
38	Indoor unit - Liquid pipe temperature (Unit No.2)	-39 – 88	°C	
39	Indoor unit - Liquid pipe temperature (Unit No.3)	-39 – 88	°C	
40	Indoor unit - Liquid pipe temperature (Unit No.4)	-39 – 88	°C	
42	Indoor unit - Cond./ Eva. pipe temperature (Unit No.1)	-39 – 88	°C	
43	Indoor unit - Cond./ Eva. pipe temperature (Unit No.2)	-39 – 88	°C	
44	Indoor unit - Cond./ Eva. pipe temperature (Unit No.3)	-39 – 88	°C	
45	Indoor unit - Cond./ Eva. pipe temperature (Unit No.4)	-39 – 88	°C	
100	Outdoor unit - Error postponement history 1 (latest)	Displays postponement code ("--" is displayed if no postponement code is present)	Code	
103	Error history 1 (latest)	Displays error history ("--" is displayed if no history is present)	Code	
104	Error history 2 (Second to last)	Displays error history ("--" is displayed if no history is present)	Code	
107	Operation mode at time of error	Displayed in the same way as request code "0"	–	
150	Indoor - Actual intake air temperature	-39 – 88	°C	
151	Indoor - Liquid pipe temperature	-39 – 88	°C	
152	Indoor - 2 phase pipe temperature	-39 – 88	°C	

Button operation

[1]

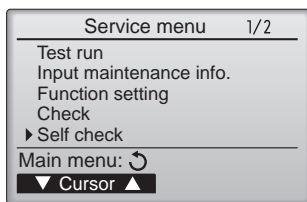

Select "Service" from the Main menu (refer to page 19), and press the button.



Select "Self check" with the **F1** or **F2** button, and press the button.

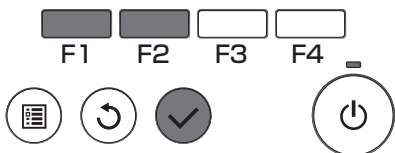

[2]

<For Mr.Slim>

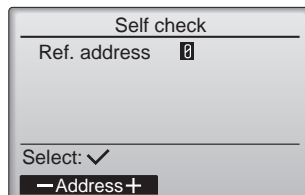

<For City Multi>

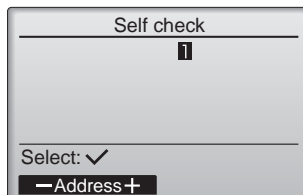

With the **F1** or **F2** button, enter the refrigerant address (Mr. Slim) or the M-NET address (City Multi), and press the button.

[3]

<For Mr.Slim>

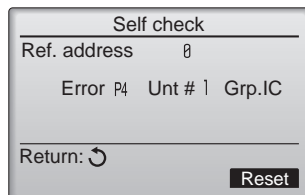

<For City Multi>

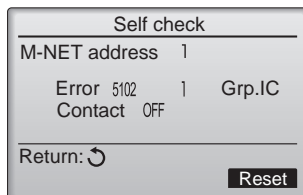

Error code, unit number, attribute, and indoor unit demand signal ON / OFF status at the contact (City Multi only) will appear. "-" will appear if no error history is available.

When there is no error history

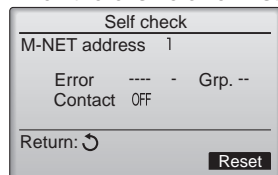

[4]

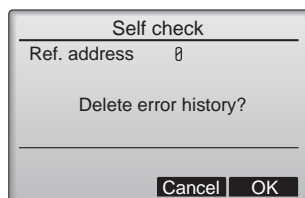

Resetting the error history.

Press the **F4** button (Reset) on the screen that shows the error history.



A confirmation screen will appear asking if you want to delete the error history.



Press the **F4** button (OK) to delete the error history.

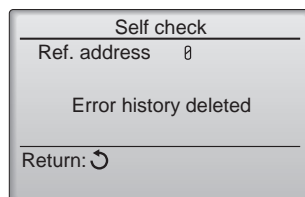

If deletion fails, "Request rejected" will appear. "Unit not exist" will appear if no indoor units that are correspond to the entered address are found.

Navigating through the screens

- To go back to the Main menu button
- To return to the previous screen button

Button operation

[1]

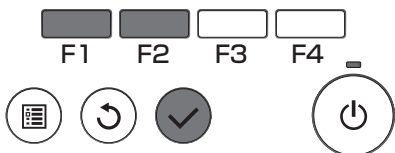
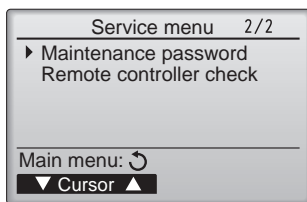

Select "Service" from the Main menu (refer to page 19), and press the button.



Select "maintenance password" with the **F1** or **F2** button, and press the button.

[2]

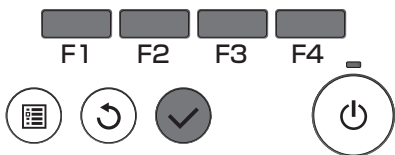
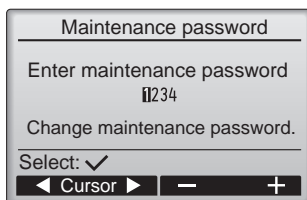

Move the cursor to the digit you want to change with the **F1** or **F2** button, and set each digit to the desired number (0 through 9) with the **F3** or **F4** button.



Press the button to save the new password.

[3]

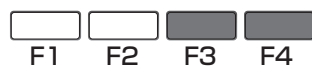
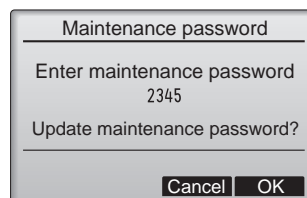

A confirmation screen will appear asking if you want to change the maintenance password.



Press the **F4** button (OK) to save the change.



Press the **F3** button (Cancel) to cancel the change.

[4]

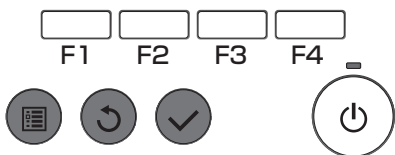
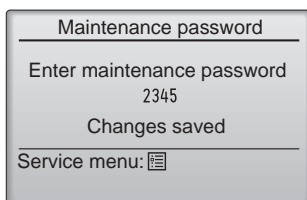

"Changes saved" will appear when the password is updated.

Press the button to return to the Service menu or press the button to go back to the "Maintenance password" screen.

Note: The default maintenance password is "9999". Change this password if necessary so that settings cannot be changed by persons other than the administrator. Store the password where it can be accessed if necessary.

Navigating through the screens

- To go back to the Main menu button
- To return to the previous screen button

If operations cannot be completed with the remote controller, diagnose the remote controller with this function.

Button operation

[1]

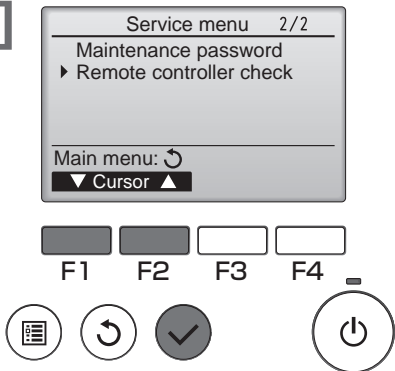

Select "Service" from the Main menu (refer to page 19), and press the button.

Select "Remote controller check" with the **F1** or **F2** button, and press the button.

[2]

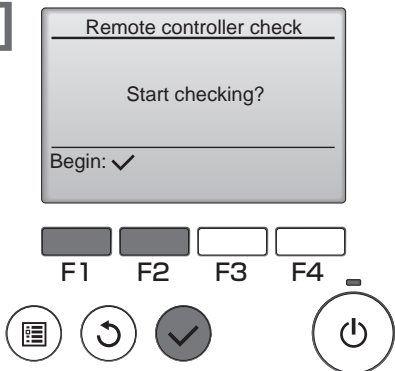

Select "Remote controller check" from the Service menu, and press the button to start the remote controller check and see the check results.

To cancel the remote controller check and exit the Remote controller check menu screen, press the or the button.

The remote controller will not reboot itself.

[3]

Remote controller check results screen

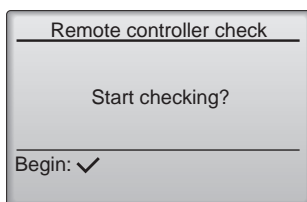

- OK:** No problems are found with the remote controller. Check other parts for problems.
- E3, 6832:** There is noise on the transmission line, or the indoor unit or another remote controller is faulty. Check the transmission line and the other remote controllers.
- NG (ALLO, ALL1):** Send-receive circuit fault. Remote controller needs replacing.
- ERC:** The number of data errors is the discrepancy between the number of bits in the data transmitted from the remote controller and that of the data that was actually transmitted over the transmission line. If data errors are found, check the transmission line for external noise interference.

If the button is pressed after the remote controller check results are displayed, remote controller check will end, and the remote controller will automatically reboot itself.

Check the remote controller display and see if anything is displayed (including lines). Nothing will appear on the remote controller display if the correct voltage (8.5 – 12 VDC) is not supplied to the remote controller. If this is the case, check the remote controller wiring and indoor units.

Installation

1. Component names and supplied parts

The following parts are included in the box.

Parts name	Qty.	Appearance
Remote controller (front cover)	1	Right figure *1
Remote controller (top case)	1	Right figure *2
Remote controller (bottom case)	1	Right figure *3
Roundhead cross slot screws M4x30	2	
Wood screw 4.1x16 (for direct wall installation)	2	
Installation Manual (this manual)	1	
Simple Operation Manual	1	
CD-ROM (Instruction Book and Installation Manual)	1	

*4 The front cover (*1) is already installed on the top case (*2) at factory shipment.

*5 Remote controller cable is not included.

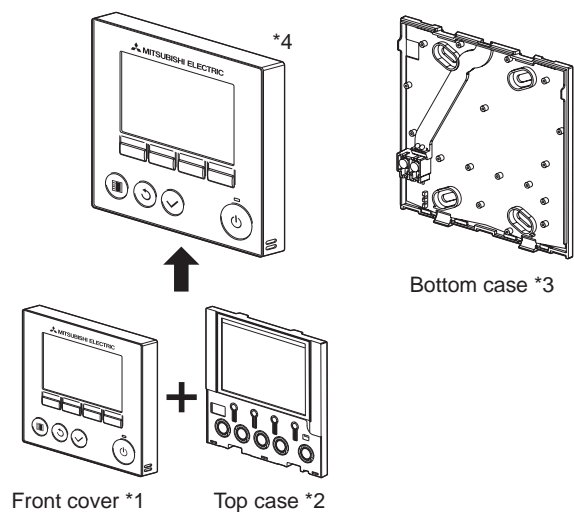

2. Field-supplied parts/Required tools

(1) Field-supplied parts

The following parts are field-supplied parts.

Parts name	Qty.	Notes
Double switch box	1	
Thin metal conduit	Necessary	Not required for direct wall installation
Lock nut and bushing	Necessary	
Cable cover	Necessary	Required for routing remote controller cable along a wall
Putty	Reasonable	
Molly anchor	Necessary	
Remote controller cable (Use a 0.3 mm ² (AWG22) 2-core sheathed cable.)	Necessary	

(2) Field-supplied tools

- Flat-tip screwdriver (Width: 4 – 7 mm (5/32 – 9/32 inch))
- Knife or Nipper
- Miscellaneous tools

3. Selecting an installation site

This remote controller is for the wall installation. It can be installed either in the switch box or directly on the wall. When performing direct wall installation, wires can be thread through either back or top of the remote controller.

(1) Selecting an installation site

Install the remote controller (switch box) on the site where the following conditions are met.

- For connection to the indoor unit with an Auto descending panel, a place where people can check the Auto descending panel operation of the indoor unit while they are operating the remote controller (Refer to the indoor unit Instructions Book for how to operate Auto descending panel.)
- A flat surface
- A place where the remote controller can measure the accurate indoor temperature Sensors to monitor indoor temperature are on the indoor unit and on the remote controller. When the room temperature is monitored with the sensor on the remote controller, the main remote controller monitors the room temperature. When using the sensor on the remote controller, follow the instructions below.
 - To monitor the accurate indoor temperature, install the remote controller away from direct sunlight, heat sources, and the supply air outlet of the air conditioner.
 - Install the remote controller in a location that allows the sensor to measure the representative room temperature.
 - Install the remote controller where no wires are routed around the temperature sensor on the controller.
(If wires are routed, the sensor cannot measure accurate indoor temperature.)

«Important»

Do not install the controller in a place where the difference between the remote controller surface temperature and the actual room temperature will be great. If the temperature difference is too high, room temperature may not be adequately controlled.

To avoid deformation and malfunction, do not install the remote controller in direct sunlight or where the ambient temperature may exceed 40°C (104°F) or drop below 0°C (32°F).

To reduce the risk of shorting, current leakage, electric shock, malfunctions, smoke, or fire, do not install the controller in a place exposed to water or in a condensing environment.

(2) Installation space

Leave a space around the remote controller as shown in the figure at right, regardless of whether the controller is installed in the switch box or directly on the wall. Removing the remote controller will not be easy with insufficient space. Also, leave an operating space in front of the remote controller.

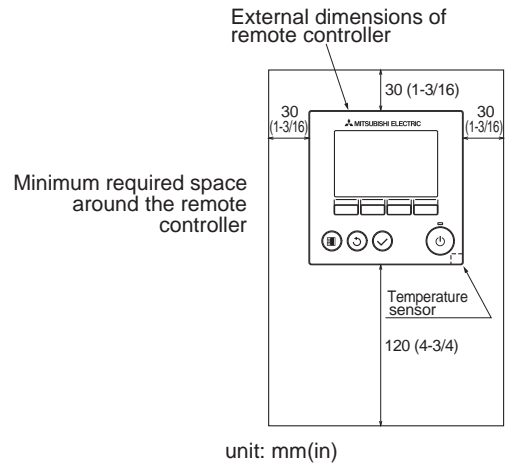

4. Installation / Wiring work

(1) Installation work

Controller can be installed either in the switch box or directly on the wall. Perform the installation properly according to the method.

① Drill a hole in the wall.

- Installation using a switch box
 - Drill a hole in the wall, and install the switch box on the wall.
 - Connect the switch box to the conduit tube.
- Direct wall installation
 - Drill a hole in the wall, and thread the cable through it.

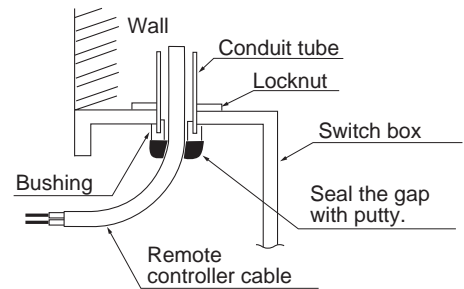

② Seal the cable access hole with putty.

- Installation using a switch box
 - Seal the remote controller cable access hole at the connection of switch box and conduit tube with putty.

To reduce the risk of electric shock, malfunctions, or fire, seal the gap between the cables and cable access holes with putty.

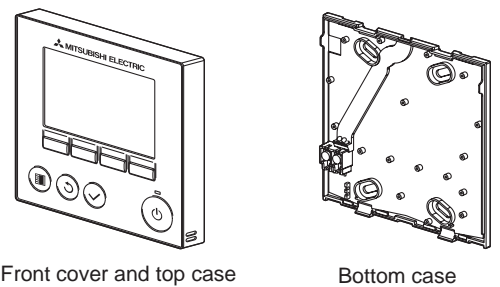

③ Prepare the bottom case of the remote controller.

④ Connect the remote controller cable to the terminal block on the bottom case.

Peel off 6 mm of the remote controller cable sheath as shown in the figure below, and thread the cable from behind the bottom case. Thread the cable to the front of the bottom case so that the peeled part of the cable cannot be seen behind the bottom case. Connect the remote controller cable to the terminal block on the bottom case.

Thread the sheath part of the cable to the front.

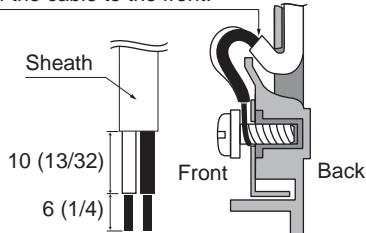

Thread the cable.

2-core wire must not be seen on the back.

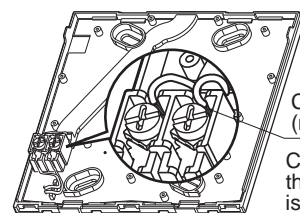
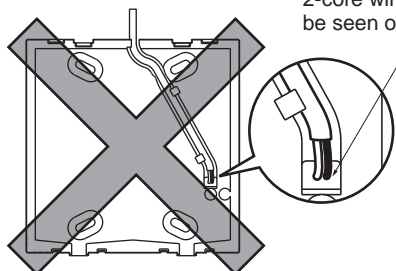

Connect the cable. (non-polarized)

Connect the cable so that the cable sheath is not pinched.

unit: mm(in)

- Direct wall installation
 - Seal the hole through which the cable is threaded with putty.

To reduce the risk of electric shock, shorting, or malfunctions, keep wire pieces and sheath shavings out of the terminal block.

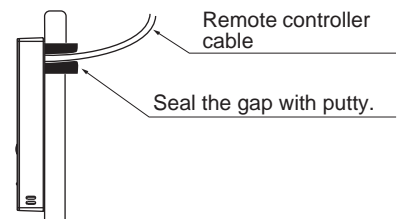

Route the cable behind the remote controller.

«Important»

Do not use solderless terminals to connect cables to the terminal block. Solderless terminals may come in contact with the circuit board and cause malfunctions or damage the controller cover.

⑤ Install the bottom case.

- Installation using a switch box
 - Secure at least two corners of the switch box with screws.
- Direct wall installation
 - Thread the cable through the groove.
 - Secure at least two corners of the remote controller with screws.
 - Be sure to secure top-left and bottom-right corners of the remote controller (viewed from the front) to prevent it from lifting. (Use molly anchor etc.)

<Installation using a switch box>

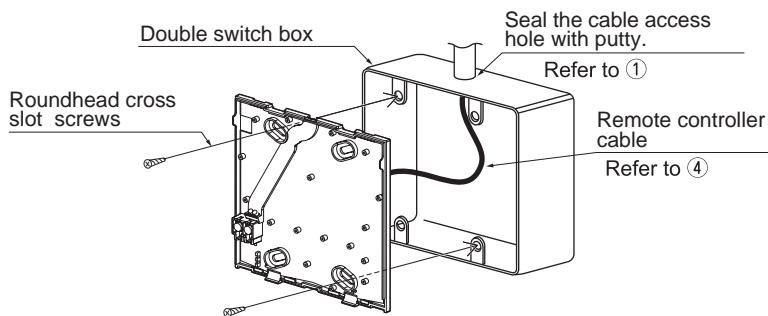

<Direct wall installation>

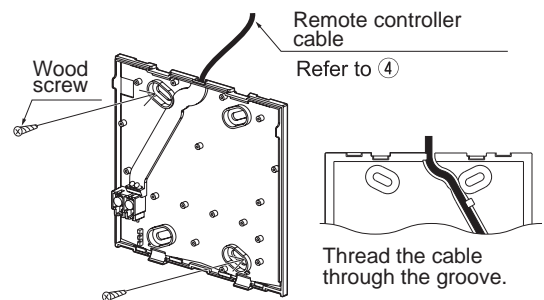

«Important»

To avoid damage to the controller, do not overtighten the screws.

To avoid damage to the controller, do not make holes on the controller cover.

⑥ Cut out the cable access hole.

- Direct wall installation (when running the cable along the wall)
 - Cut out the thin-wall part on the cover (indicated with diagonal lines in the right figure) with a knife or a nipper.
 - Thread the cable from the groove behind the bottom case through this access hole.

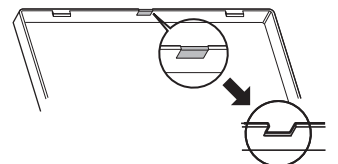

⑦ **Route the wire to the top case.**

Connect the connector on the bottom case to the connector on the top case.

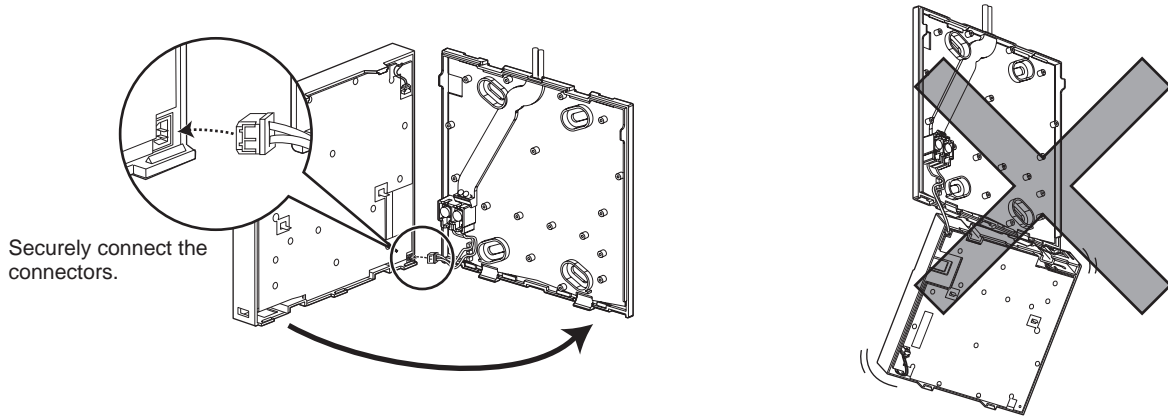

Securely connect the connectors.

«Important»

To prevent malfunctions, do not remove the protective film or the circuit board from the casing.

To prevent cable breakage and malfunctions, do not hang the top controller casing hang by the cable.

⑧ **Route the wire to the top case.**

«Important»

Hold the cables in place with clamps to prevent undue force from being applied to the terminal block and causing cable breakage.

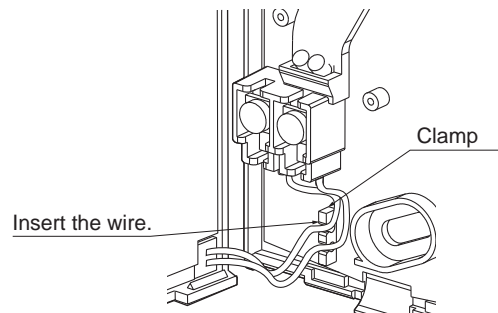

⑨ **Install the front cover and top case on the bottom case.**

Two mounting tabs are at the top of the top case. (A cover is already installed on the case at the time of factory shipment.) Hook those two tabs onto the bottom case, and click the top case into place. Check that the case is securely installed and not lifted.

«Important»

When attaching the cover and the top casing to the bottom casing, push it until it they click into place. If they are not properly locked into place, they may fall, causing personal injury, controller damage, or malfunctions.

- Direct wall installation (when running the cable along the wall)
 - Thread the cable through the access hole at the top of the remote controller.
 - Seal the cut-out part of the cover with putty.
 - Use a cable cover.

Installation is complete.
Follow the instructions below when uninstalling them.

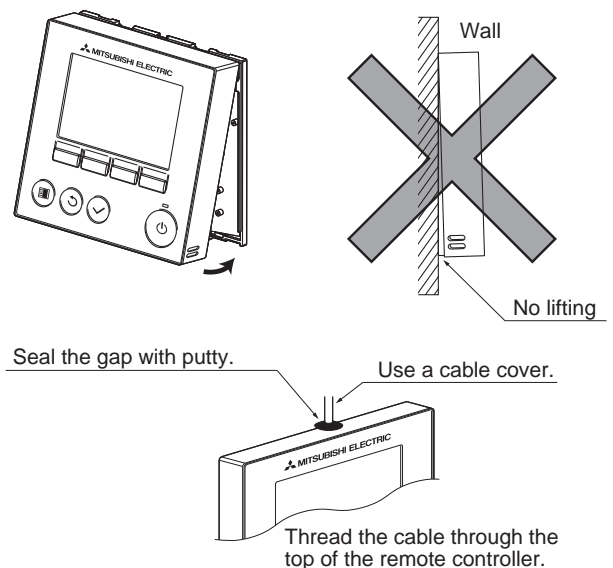

<Uninstalling the front cover and top case>

① Uninstalling the front cover

Insert a flat-tip screwdriver into either of the two latches at the bottom of the remote controller, and move it in the direction of the arrow as shown in the figure at right.

② Uninstalling the top case

Insert a flat-tip screwdriver into either of the two latches at the bottom of the remote controller, and move it in the direction of the arrow as shown in the figure at right.

«Important»

Use a flat-head screwdriver with a blade width of 4-7 mm (5/32-9/32 inch). The use of a screwdriver with a narrower or wider blade tip may damage the controller casing.

To prevent damage to the control board, do not insert the driver into the slot strongly.

To prevent damage to the controller casing, do not force the driver to turn with its tip inserted in the slot.

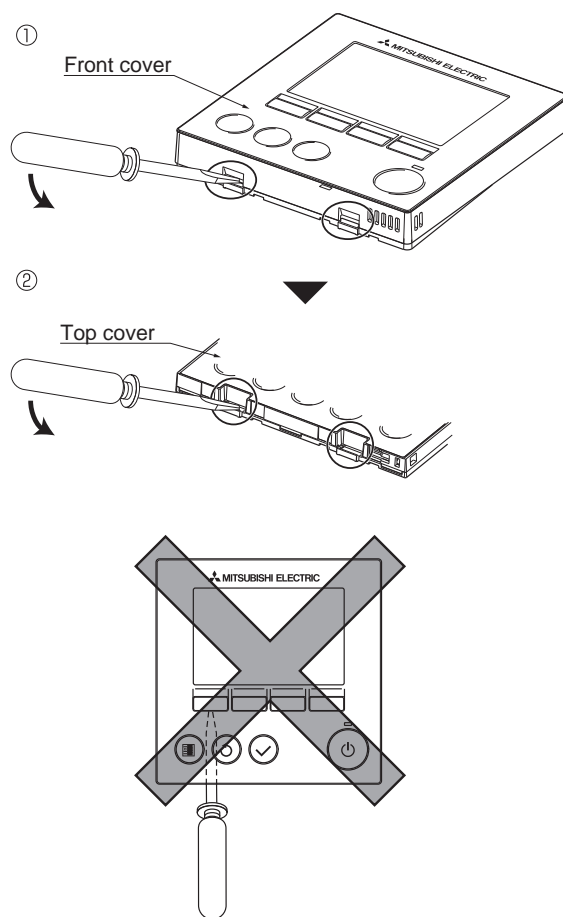

③ Installing the cover and top case

Two mounting tabs are at the top of the top case. Hook those two tabs onto the bottom case, and click the top case into place. Install the cover on the top case in the same way as with the top case. Check that the top case is securely installed and not lifted.

«Important»

When attaching the cover and the top casing to the bottom casing, push it until it they click into place. If they are not properly locked into place, they may fall, causing personal injury, controller damage, or malfunctions.

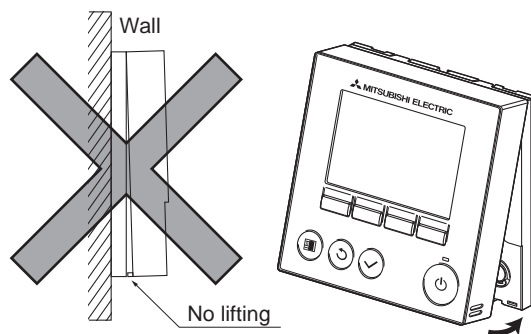
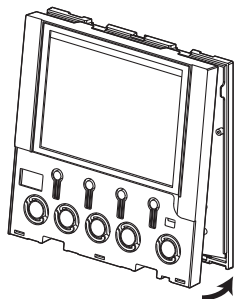

5. Important

- Discrepancy between the indoor temperature measured at the wall and the actual indoor temperature may occur. If the following conditions are met, the use of the temperature sensor on the indoor unit is recommended.
 - Supply air does not reach to the wall easily where the remote controller is installed due to improper airflow distribution.
 - There is a great discrepancy between the wall temperature and the actual indoor temperature.
 - The back side of the wall is directly exposed to the outside air.
- Refer to the section on main/sub setting in the Initial Setting Manual on the CD-ROM for remote controller main/sub setting.
- Refer to either of the following manuals for temperature sensor setting: indoor unit Installation Manual for City Multi; remote controller Initial Setting Manual on the CD-ROM for Mr. Slim.
- At the time of factory shipment, protective sheet is on the operation interface of the front cover. Peel off the protective sheet on the operation interface prior to use.

6. Connecting the transmission wire

The remote controller wiring differs according to whether it is connected to a multi air conditioner or Mr. Slim air conditioner. The method also varies according to the system configuration. Always check before starting.

(1) Connecting to a multi air conditioner

(a) to (d) in the following figure correspond to (a) to (d) in the explanations.

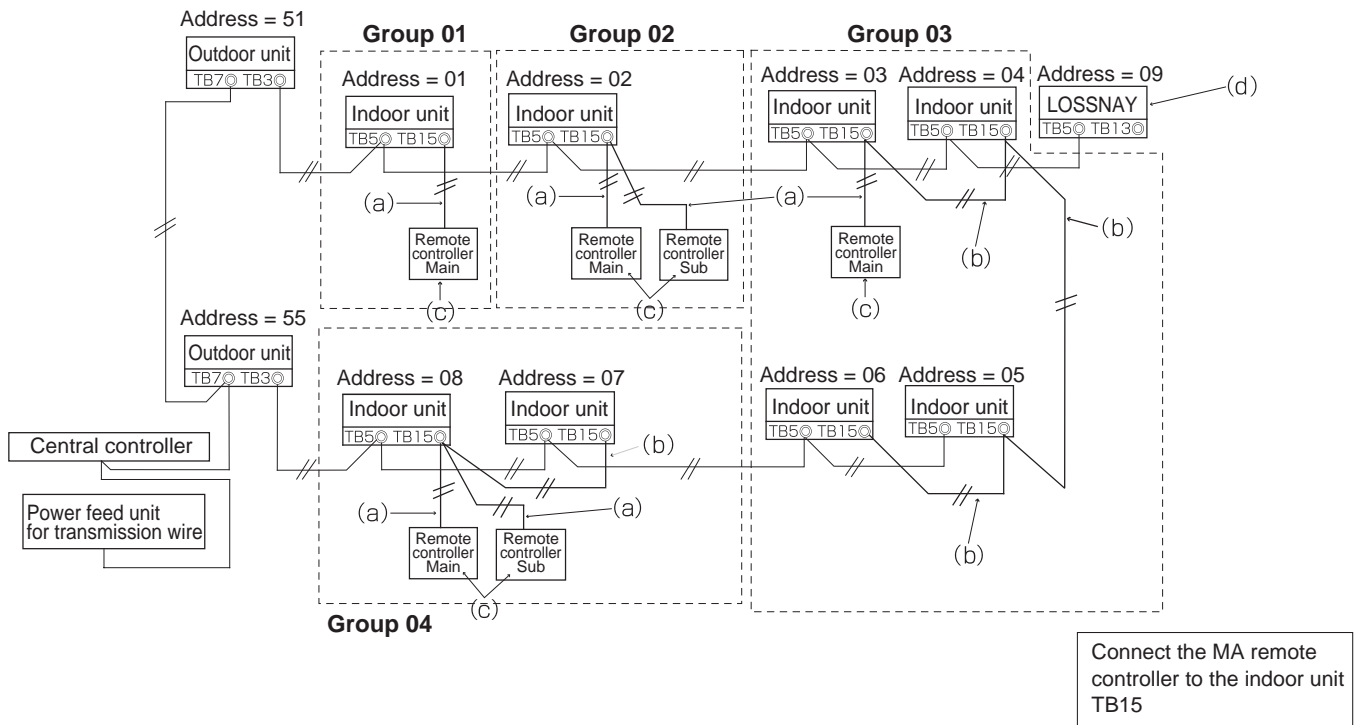

(a) Wiring the remote controller and indoor unit

- Connect to the terminal block (TB15) for the indoor unit's MA remote controller wire.
- Connect to the remote controller's terminal block (symbol A, B). The terminal block has no polarity.

(b) When operating groups (Group 03 and 04 above)

- Use a crossover wire between the terminal block (TB15) for the MA remote controller wires of the indoor units to be operated in a group, and connect the remote controller to the crossover.
- When using with the MELANS system controller as shown above, the group must be set on the system controller (central controller shown above).

(c) Overall distance of remote controller cable, and number of connectable remote controllers

The restrictions differ according to the connected indoor unit. Refer to the catalog or system design and work manual, etc. The overall distance when connecting one remote controller is 200m.

(d) When running a LOSSNAY in conjunction, refer to the Installation Manual (Setting Section) and set the remote controller.

(2) Connecting to Mr. Slim air conditioner

The remote controller wiring will vary according to the system configuration. Refer to the following example, and connect.

(a) to (c) in the following figure correspond to (a) to (c) in the explanations.

When connecting a remote controller for each refrigerant system(Standard 1:1, Twin, Triple, Quadruple)

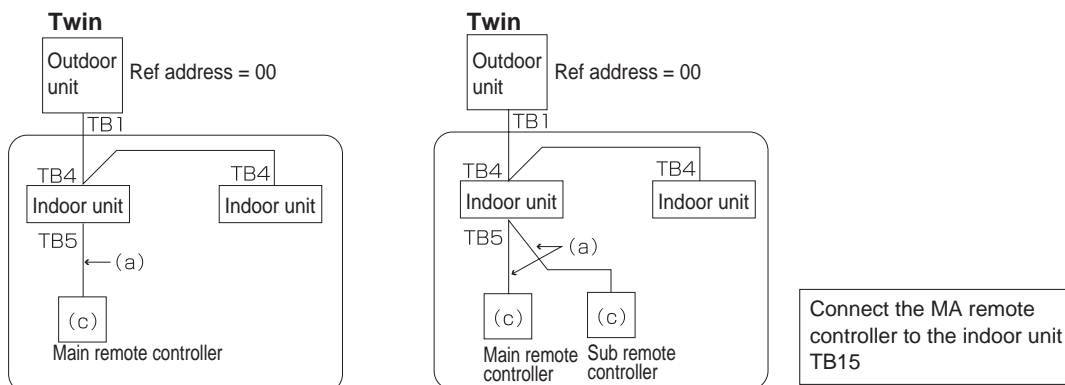

When grouping in different refrigerant systems

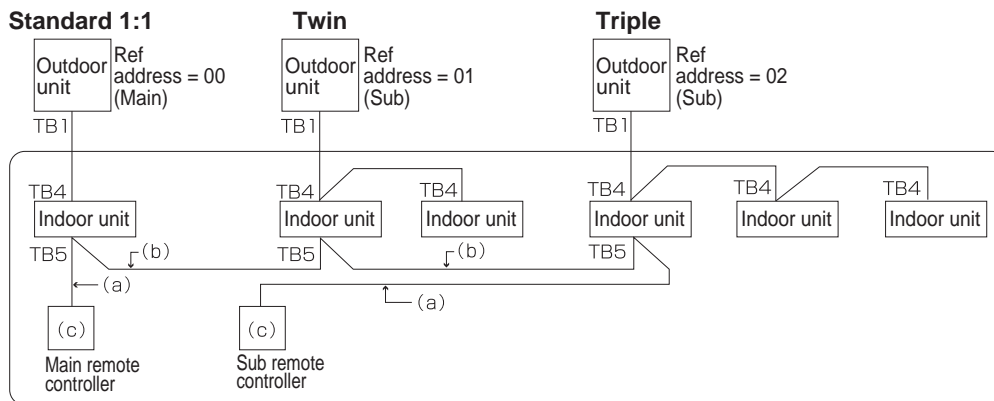

- * The refrigerant address is set with the outdoor unit's DIP switch. (Refer to the Outdoor Unit Installation Manual for details.)
- * All indoor units enclosed in the box are controlled as one group.

(a) Wiring the remote controller and indoor unit

- Connect to the terminal block (TB5) for the indoor unit's remote controller wire. (The terminal block has no polarity.)
- When using the simultaneous multi-type and different indoor unit models exist, always connect the remote controller to the indoor unit having the most functions (wind speed, vane, louver, etc.).

(b) Wiring to group with different refrigerant systems

- Groups are formed with the remote controller cables. Use crossover wires between the remote controller terminal blocks (TB5) of the main indoor unit in each refrigerant system to be grouped.
- If there are different indoor unit models in the same group, always use the outdoor unit to which the indoor unit with most functions (wind speed, vane, louver, etc.) is connected as the main unit (refrigerant address = 00).

If the main unit is a simultaneous multi-type, make sure that the conditions in (a) above are satisfied.

- Up to 16 refrigerant systems can be controlled as one group using the MA remote controller.

(c) Up to two remote controllers can be connected to one group.

- If two remote controllers are connected to one group, always set the main remote controller and sub remote controller.
- If only one remote controller is connected to the group, always set the main remote controller. If two remote controllers are connected to one group, set each remote controller as the main or sub remote controller. (Refer to the Installation Manual (Setting Section).)

(d) Overall distance of remote controller cable

- The overall distance is 500m. Use a 0.3m² 2-core cable for the remote controller cable. (Procure locally.)
- The overall distance is 200m when two remote controllers are connected.

«Note»

Do not use a crossover wire between the remote controller terminal blocks (TB5) for the indoor units within the same refrigerant system.

- ▶ The system may not operate correctly if a crossover wire is used.

When connecting to the remote controller terminal block (TB5) of the indoor unit, up to two wires having the same size can be connected to one terminal block.

- ▶ Improper connections can result in contact defects or wire disconnection.

Do not use crossover wires between the remote controllers.

- ▶ Only one wire can be connected to the remote controller's terminal block.

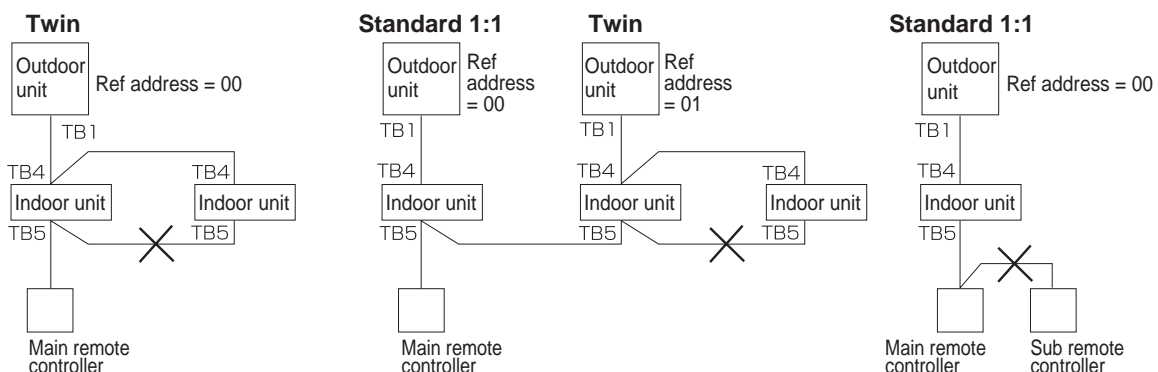

System control (for Mr.Slim)

Variety Of System Function

System Name	System Diagram	Features	Parts Required in Addition to Standard System Components (Indoor / Outdoor Units, Remote Controller)
A. Remote controller operation (Standard) Use of 2 controllers enables operation of the air conditioner both from a distance and nearby.		<ul style="list-style-type: none"> • There are 2 types of remote controllers: wired type and wireless type. • Simultaneous twin, triple and quad units are counted as 1 unit, and the indoor units are started or stopped simultaneously. 	—
B. Remote controller operation Use of 1 remote controller to control multiple air conditioners with the same settings simultaneously.	<p>* One of the wired remote controllers must be set as a sub remote controller.</p>	<ul style="list-style-type: none"> • Up to 2 remote controllers can be connected to one group. • Simultaneous twin, triple and quad units are counted as 1 unit. • Operation control by the latest command (last entered priority) • Wired and wireless remote controllers can be combined as a pair. 	Wired remote controller (additional) (PAR-31MAA) For PKA-RP · HAL / KAL, use the terminal block. (PAC-SH29TC-E)
C. Group control operation Allows start / stop of the air conditioner from a distance, and prohibits / permits start/ stop from remote controllers.	<p>* Outdoor unit's refrigerant address needs to be set.</p>	<ul style="list-style-type: none"> • One group can consist of up to 16 indoor units, and they can be started sequentially by connecting the remote controller to them and assigning an address to each outdoor unit. • Simultaneous twin, triple and quad units are counted as 1 unit. • All the units belonging to the same group are operated in the same mode, but thermostats can be turned ON / OFF individually for each outdoor unit. • Up to 2 remote controllers can be connected. 	Wired remote controller (additional) (PAR-31MAA) For PKA-RP · HAL / KAL, use the terminal block. (PAC-SH29TC-E)
D. Remote / local combined control operation Enables you to display the operation state and control start/stop from a distance.		<ul style="list-style-type: none"> • All the air conditioners can be turned ON / OFF collectively from a distance. • Operation can be switched between the remote operating panel and local controller. • Operations (e.g., temperature adjustment, airflow, airflow direction) except for start/stop operations can be performed even if operations from the local remote controller are prohibited. • In the case of simultaneous twin, triple, quad units, connect the controller to one indoor unit only. • If connected to 2 or more indoor units, an error may occur. (operation stop) Control by an external timer is possible by connecting it. 	Remote ON / OFF adapter (PAC-SE55RA-E) Relay box (Part to be provided at your site) Remote operating panel (Part to be provided at your site)
E. Operation by external signal	—	Use of optional "remote ON / OFF adapter" enables remote control via relay. (Level signal)	Remote ON / OFF adapter (PAC-SE55RA-E)
F. Control by external signal and remote display		Extraction of non-voltage contact output Use of optional "remote operation adapter" and "remote display panel" (Part to be provided at your site) provides non-voltage contact outputs of signals (operation, error) and operation / stop input function.	Remote operation adapter (PAC-SF40RM-E) Remote display panel (Part to be provided at your site)
		Extraction of DC12 V contact output Use of optional "Multiple remote controller adapter" and "remote display panel" (Part to be provided at your site) provides DC12 V contact outputs of signals (operation, error) and operation / stop input function.	Multiple remote controller adapter (PAC-SA88HA) Remote display panel (Part to be provided at your site)

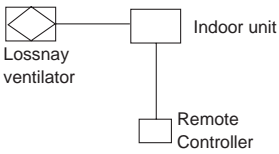
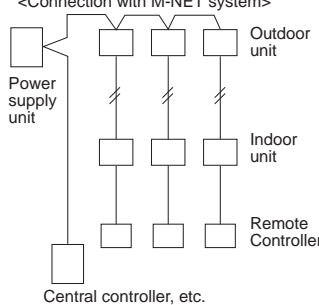
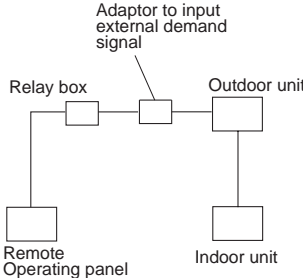
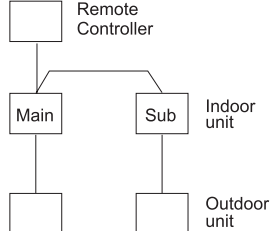
System Name	System Diagram	Features	Parts Required in Addition to Standard System Components (Indoor / Outdoor Units, Remote Controller)
<p>G. Timer operation</p> <p>Enables control of start and stop.</p> <p>* For control by external timer, refer to Remote/ local combined control operation".</p>		<ul style="list-style-type: none"> • Weekly timer: In addition to ON/OFF, up to 8 temperature patterns can be set for each day of the week. * Only one timer can be selected; the auto off, simple and weekly timers cannot be combined. • Simple timer: Start and stop operations can each be performed once within 72 hours (can be set in 1-hour increments). • Auto off timer: Operation is stopped when the pre-set time elapses following the start of operation. The time can be set from 30 minutes to 4 hours in 30-minute increments. * Only one timer can be selected; the simple and auto off timers cannot be combined. 	<p>MA Remote controller (PAR-30MAA)</p>
<p>H. Interlock operation with peripheral equipment</p> <p>Enables control of Mitsubishi Lossnay ventilator by remote controller.</p>		<ul style="list-style-type: none"> • Connecting a Lossnay ventilator and an indoor unit enables control of interlock/ solo ventilation operation and airflow. (Only the microcomputer type Lossnay ventilator can be used.) 	
<p>I. Central control</p>	<p><Connection with M-NET system></p> 	<ul style="list-style-type: none"> • Connecting the M-NET connection adapter to outdoor unit enables connection of MELANS system controller (for M-NET). • When using A-control operation, the number of indoor units in a MELANS system is limited to the number of outdoor units. (Simultaneous twin, triple and quad units are counted as 1 unit.) • Number of controlled outdoor units Central controller: 50 units Group remote controller (PAC-SC-30GR): 16 units 	<p>M-NET adapter (Option PARTS) Central controller (G-50A) Group remote controller (PAC-SC30GR), etc.</p>
<p>J. Demand control</p>		<ul style="list-style-type: none"> • Demand control is available by external input. In this mode, power consumption is decreased within the range of usual 0-100%. 	<p>Adapter to input external demand signals. (PAC-SC36NA-E) Relay box (Part to be provided at your site) Remote operating panel (Part to be provided at your site)</p>
<p>K. Rotation</p>		<ul style="list-style-type: none"> • Rotation Main and sub unit operate alternately according to the interval of rotation setting. • Back-up When abnormality occurs while operation, it changes into operating the backup unit, and operation is continued. • 2nd stage cut-in • Number of operating units is determined according to the room temperature and set point. • When room temperature becomes higher than set point, standby unit starts.(2 units operation) • When room temperature falls below set point -4°C, standby unit stops. (1 unit operation) 	<p>This function is available when only 2 indoor units are connected to each PUHZ type outdoor unit.</p> <p>Application model Indoor unit PLA-(Z)RP · BA(2) PCA-RP · KAQ / HAQ PKA-RP · HAL / KAL PSA-RP · KA PEAD-RP · JA(L)Q / GAQ</p>

1. Remote Controller (Standard) Operation

1-1. Wired Remote Controller

(OC: Outdoor unit IC: Indoor unit R: Remote controller (for wireless type: optical receiver adapter))

Slim Air Conditioners System		Standard 1:1	Simultaneous Twin	Simultaneous Triple	Simultaneous Quad	
System diagram (Wired remote controller)	Outdoor unit OC	Indoor/Outdoor connection cable Remote controller cable				
	Indoor unit IC					
	Wired remote controller R					

* Numbers given in () apply when power is supplied to the indoor and outdoor units separately.

<Reference>

- 1) If simultaneous twin or triple or quad, connect the remote controller to any one of the indoor units. All functions of the indoor unit can be controlled even if different models (different types) are mixed.
- 2) Do not use crossover wiring among indoor units with simultaneous twin, triple, quad units. (Prohibited item.)
- 3) Electrical wiring diagram

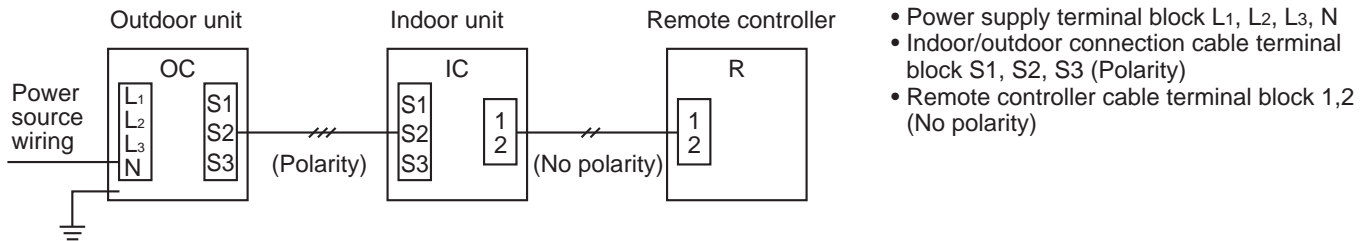

1-2. Wired Remote Controller or Wireless Remote Controller Receiver Built into Indoor Unit

Slim Air Conditioners System		Standard 1:1	Simultaneous Twin	Simultaneous Triple	Simultaneous Quadruple	
System diagram (Wireless remote controller receiver)	Outdoor unit OC	Indoor/Outdoor connection cable				
	Indoor unit IC					
	Wireless remote controller receiver section R'					

(Reference)

- 1) If simultaneous twin, triple or quadruple connect the remote controller to an indoor unit. All functions of the indoor unit can be controlled even if different models (different types) are mixed. Note that there may be some restrictions of the functions.
- 2) Do not use crossover wiring among indoor units with simultaneous twin, triple or quadruple units. (Prohibited item.)
- 3) Electrical wiring diagram

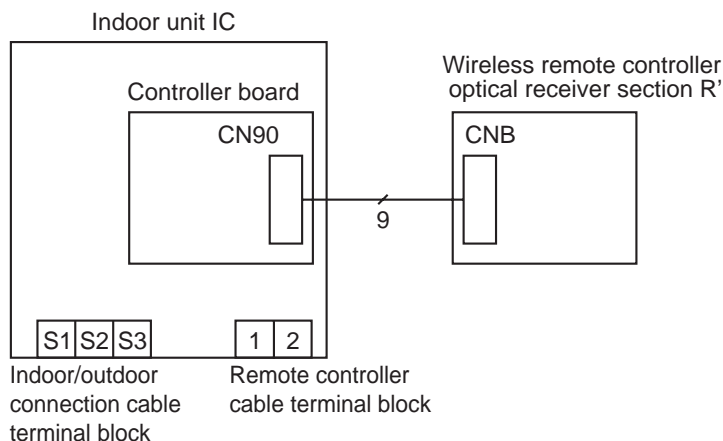

2. 2-remote Controller Operation

2-1. 2 Wired Remote Controllers

(R: Wired remote controller)

Slim Air Conditioners System		Standard 1:1	Simultaneous Twin
System diagram (Wired remote controller)	Outdoor unit OC		
	Indoor unit IC		
	Wired remote controller R		
System diagram (Wired remote controller)	Outdoor unit OC		
	Indoor unit IC		
	Wired remote controller R		

Slim Air Conditioners System		Simultaneous Triple	Simultaneous Quad
System diagram (Wired remote controller)	Outdoor unit OC		
	Indoor unit IC		
	Wired remote controller R		
System diagram (Wired remote controller)	Outdoor unit OC		
	Indoor unit IC		
	Wired remote controller R		

* Numbers given in () apply when power is supplied to the indoor and outdoor units separately.

<Reference>

- 1) If simultaneous twin or triple or quad, connect the remote controller to any one of the indoor units. All functions of the indoor unit can be controlled even if different models (different types) are mixed.
- 2) Do not use crossover wiring among indoor units with simultaneous twin, triple, quad units. (Prohibited item.)
- 3) Set one of the remote controllers as the main controller (initial setting) and the other as the sub controller using the remote controller's function selection.

2-2. 1 Wired and 1 Wireless Remote Controller

(R: Wired remote controller, R': Wireless remote controller receiver)

Slim Air Conditioners System		Standard 1:1	Simultaneous Twin
System diagram (Wired remote controller and wireless remote controller receiver)	Outdoor unit OC		
	Indoor unit IC		
	Wired remote controller Receiver R·R'		
System diagram (Wired remote controller and wireless remote controller receiver)	Outdoor unit OC		
	Indoor unit IC		
	Wired remote controller Receiver R·R'		

* Numbers given in () apply when power is supplied to the indoor and outdoor units separately.

<Reference>

- 1) If simultaneous twin or triple or quad, connect both the wired remote controller and wireless remote controller receiver to any one of the indoor units. All the functions of the indoor unit can be controlled even if different models (different types) are mixed.
- 2) Do not use crossover wiring among indoor units with simultaneous twin, triple, quad units. (Prohibited item.)
- 3) When using 2 or more remote controllers, the display contents on the remote controllers may differ from the actual settings, since the operation mode last by any of the wireless remote controllers will be effective.

3. Group Control Operation

(Collective Operation And Control Of Multiple Refrigerant Systems (2 to 16))

- Multiple Mr.Slim air conditioners can be operated with the same settings (e.g., operation mode, preset temperature, etc.) by using 1 remote controller. Each outdoor unit can be turned ON / OFF individually by the intake sensor.
 - Up to 16 refrigerant systems can be controlled as a group by 1 remote controller.
 - A refrigerant address must be set for each outdoor unit. Addresses "0" to "15" can be set with no duplicates. Address "0" must be set for one of the outdoor units.
- * In the case of simultaneous twin, triple units, only 1 refrigerant system is used.

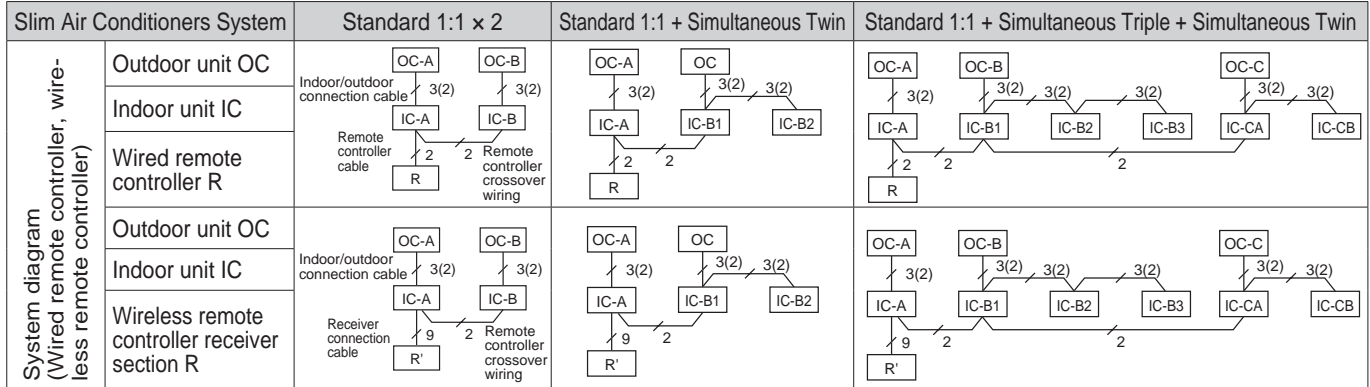

* Numbers given in () apply when power is supplied to the indoor and outdoor units separately.

<Reference>

- For 2-remote controller control, refer to "2-1. 2-Remote Controller Operation". However, when using both wired and wireless remote controllers, receivers must be connected to indoor units that are connected by crossover wiring.
- Connect an indoor unit having the highest functions among the group to the outdoor unit assigned to refrigerant address "0" (Refer to the example given below). The remote controller operation follows the function of the unit that has the highest functions among the group.

Function specifications <Example>

Item		4-way ceiling cassette	Ceiling suspended	Ceiling suspended (suitable for kitchen)	Wall mounted	Floor standing	Ceiling concealed			
		PLA-(Z)RP-BA(2)	PCA-RP-KAQ	PCA-RP-HAQ	PKA-RP-HAL/KAL	PSA-RP-KA	PEAD-RP-JA(L)Q	PEA-RP-200/250GAQ	PEA-RP-400/500GAQ	
Function	Fan	Notch	4 speed + Auto	4 speed + Auto	2 speed	3 speed + Auto	2 speed	3 speed + Auto	2 speed	1 speed
	Up/down vane	Presence / absence	○	○	×	○	×	×	×	×
		Direction setting	5 direction + Auto	5 direction + Auto	×	5 direction + Auto	×	×	×	×
		Swing function	○	○	×	○	×	×	×	×
Left/right swing louver	Presence / absence	×	×	×	×	○	×	×	×	

- In the case of free component multi type systems consisting of simultaneous twin, triple and quad units, the indoor units should not be connected by crossover wiring. (Prohibited)
- PKA-RP-HAL/KAL models do not have a remote controller terminal block. Attach the terminal block for remote controller (option).

<System diagram>

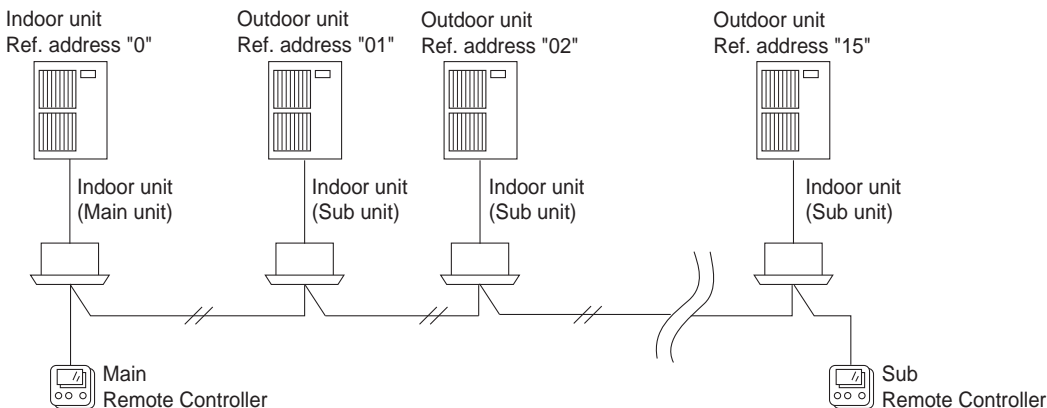

Outdoor unit No.(Ref.address)	00	01	02			15	Setting by the switch
Indoor unit No.	1	1	1			1	Auto configuration
Remote controller feeding(Indoor unit : Main)	○	-	-			-	

<Work procedures>

- Connect the remote controller to one of the indoor units, and connect each refrigerant system with a crossover wire. Always wire from the indoor unit.
- Set the refrigerant address for each outdoor unit, and turn the power ON.
Set the refrigerant address before turning the power ON.
- * The power for the remote controller is supplied from the address 00 indoor unit. (LED2 on the indoor control board will light.)

<Outdoor unit address setting>

- For group control, an address must be set for each outdoor unit.
- To set addresses to outdoor units, use the DIP switch SW1 (3-6) provided on each outdoor control board (Initial setting: All are set to "OFF".)
- Address setting by SW1 is as follows.

		Function	Operation by switch	
			ON	OFF
SW1 Function selection	1	Forced defrosting	Start	Normal
	2	Error history clear	Clear	Normal
	3	Refrigerant address setting	Used to set outdoor unit addresses ("0" to "15").	
	4	↑		
	5	↑		
	6	↑		

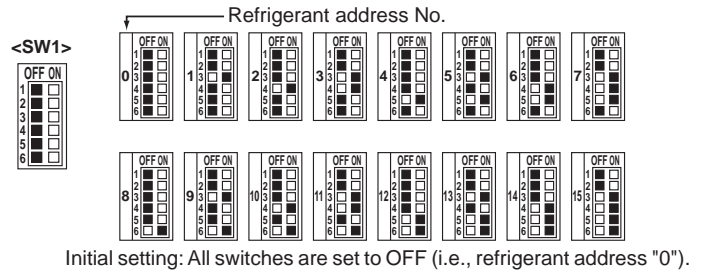

* Checking the outdoor unit refrigerant addresses

To find the location of an outdoor unit with a specific refrigerant address, specify the address in self-diagnosis mode. The outdoor unit will operate intermittently.

<Sequential Start Timer>

The refrigerant address also acts as a sequential start timer (one-second interval) to suppress the rush current. The initial refrigerant address is 0. In this case, the sequential start timer is "0", and the delay time is * 0 to 9. Depending on the combination of the No. 3 to 6 switch settings, the units can be sequentially started at one-second intervals between 1 to 15 (delay time is 10 to 24).

- * Differs according to the remote controller operation timing.
(Example) Sequential start timer 12 = 8 + 4 → Switch No. 5 and 6 ON

Refrigerant address setting and sequential start timer following SW1 (No. 3 to 6) switch operations

Setting details	ON					
	1	2	3	4	5	6
Refrigerant address	1	2	4	8		
Sequential start timer	1	2	4	8		
Delay timer (Sec.)	10	11	13	17		

■ : Indicates switch position

<Confirming the outdoor unit address>

To determine which outdoor unit corresponds to the designated refrigerant address, designate the refrigerant address with the self-diagnosis mode. The designated outdoor fan will run intermittently. With the initial setting (refrigerant address 0), the sequential start timer is "0" and the delay time is * 0 to 9.

4. Power Outage Automatic Recovery Operation

- Whenever a power outage or switching of the power supply causes the power supply of an operating air conditioner to go from OFF to ON, this function will automatically restore the operation of the air conditioner to its previous operating mode.
- If the power is turned from OFF to ON when the air conditioner is not in operation, the air conditioner will not automatically be turned on. However, the timer operation will be cancelled if the air conditioner is in timer operation (including when the unit is waiting for its start time). Setting for timer operation must be performed once again.
- If there is a momentary power outage of less than 1 second while the air conditioner is in operation, there may not be a clear determination of whether or not there was a power failure. When it has been determined that there has been a power failure, recovery will take approximately 4 minutes after the power is restored. So please wait. (Once "PLEASE WAIT" has appeared on the display, a protection system will operate to prevent the unit from restarting for 3 minutes.) When it has been determined that there has been no power failure, operation will continue as is.
- Settings can be made by function selections from the remote controller.
- When there is group control, selection of all refrigerants is required.

■ Judging a power outage during an instantaneous power failure

When an instantaneous power failure occurs, the air conditioner judges that a power outage has occurred depending on the length of the power failure as shown below.

If it is determined that a power outage has occurred, the air conditioner will stop. (Even if the power is recovered after the instantaneous power failure, the air conditioner will remain stopped.)

Unit operation during power outage		
Instantaneous power failure	Time for unit operation to change after power outage	Standard model (model without inverter): approx. 40ms Inverter model: approx. 100ms (Varies according to the power voltage during operation and the operation state.)
	What occurs after the above time elapses?	Operation stop (An error extension occurs when the outdoor unit's compressor over-current shutoff occurs, so the operation may restart after three minutes. The time that an error extension occurs varies according to the operation load and power voltage.)
	What happens when the power is restored?	Operation remains stopped. However, when automatic restart after power failure is set, the state will return to the pre-power failure state.
Power outage lasting more than one minute	What happens when the power fails?	Operation stops
	What happens when the power is restored?	Operation remains stopped. However, when automatic restart after power failure is set, the state will return to the pre-power failure state.
Unit operation during power outage		If automatic restart after power failure is set, the unit can be restored to the pre-power failure state after the power is recovered. (Note) Automatic restart after power failure can be set with the remote controller function settings.

* To return the air conditioner to the pre-power failure operation state after the power is restored (to resume operation if the air conditioner was running, or stay stopped if it was stopped), enable the "automatic restart after power failure" mode with the remote controller function selection.

After the power is restored, the air conditioner will resume operation after the system startup time (20 seconds to 1 minute) and the balance time to protect the compressor (3 minutes) have elapsed.

5. Individual Control Operation From A Separate Room

- By simply centralizing the remote controllers installed in each room in a separate control room, individual control or centralized monitoring of the air conditioners in each room can be attained.
- Air conditioner control can be performed up to a total of 500 meters away by connecting the indoor units and remote controllers with 0.3 to 1.25 mm² 2-core cable.

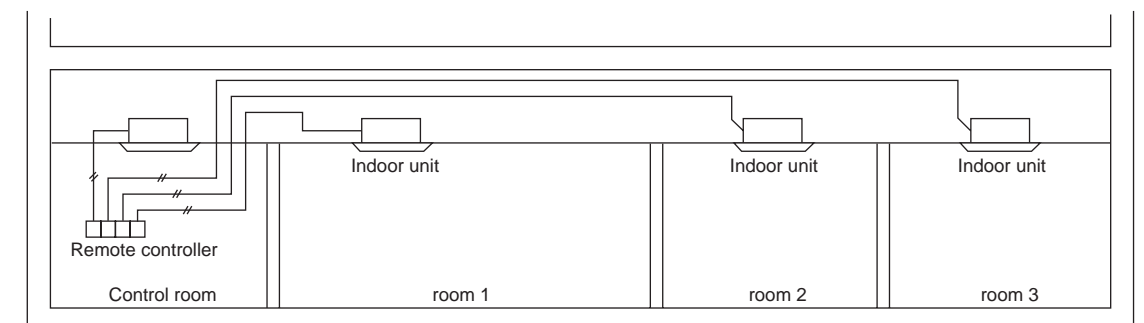

- If a remote controller is installed in a room and control room, refer to the section on operating with 2 remote controllers.

6. Mode set by external input

6.1 Low -level sound priority mode (Local wiring)

By performing the following modification, operation noise of the outdoor unit can be reduced by about 3-4 dB.

The low noise mode will be activated when a commercially available timer or the contact input of an ON/OFF switch is added to the CNDM connector (option) on the control board of the outdoor unit.

- The ability varies according to the outdoor temperature and conditions, etc.
 - ① Complete the circuit as shown when using the external input adapter (PAC-SC36NA-E). (Option)
 - ② SW7-1 (Outdoor unit control board): OFF
 - ③ SW1 ON: Low noise mode
SW1 OFF: Normal operation

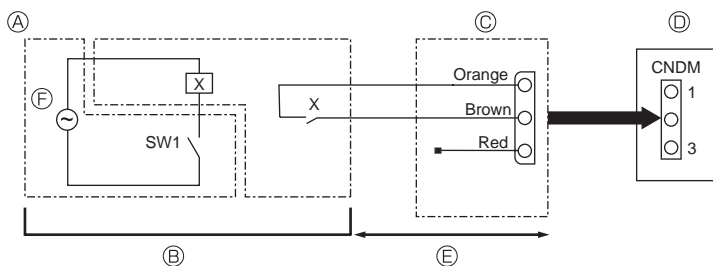

- Ⓐ Circuit diagram example (low noise mode)
- Ⓑ On-site arrangement
- Ⓒ External input adapter (PAC-SC36NA-E)
- X: Relay (DC15V. 0.1 or more)
- Ⓓ Outdoor unit control board
- Ⓔ Max. 10 m
- Ⓕ Power supply for relay

6.2 On demand control (Local wiring)

By performing the following modification, energy consumption can be reduced to 0–100% of the normal consumption. The demand function will be activated when a commercially available timer or the contact input of an ON / OFF switch is added to the CNDM connector (option) on the control board of the outdoor unit.

- ① Complete the circuit as shown when using the external input adapter (PAC-SC36NA-E). (Option)
- ② By setting SW7-1 on the control board of the outdoor unit, the energy consumption (compared to the normal consumption) can be limited as shown below.

	SW7-1	SW2	SW3	Energy consumption
Demand function	ON	OFF	OFF	100%
		ON	OFF	75%
		ON	ON	50%
		OFF	ON	0%(Stop)

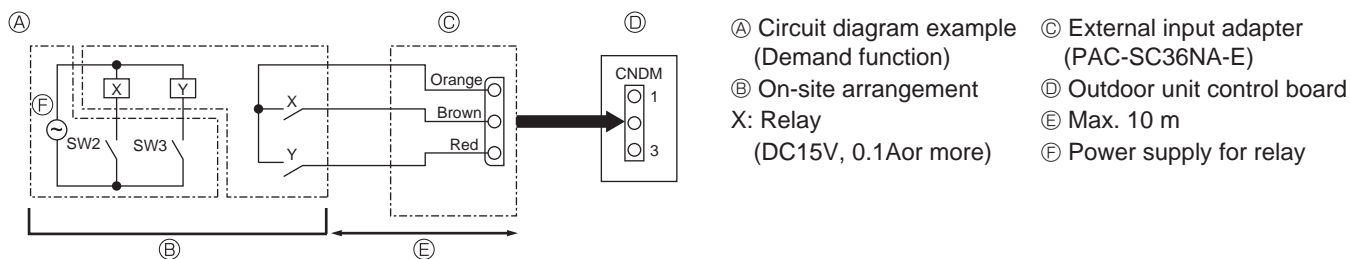

■ Operation when using both remote controller settings and external input

When using both the remote controller and external input, the lower setting value will be valid.

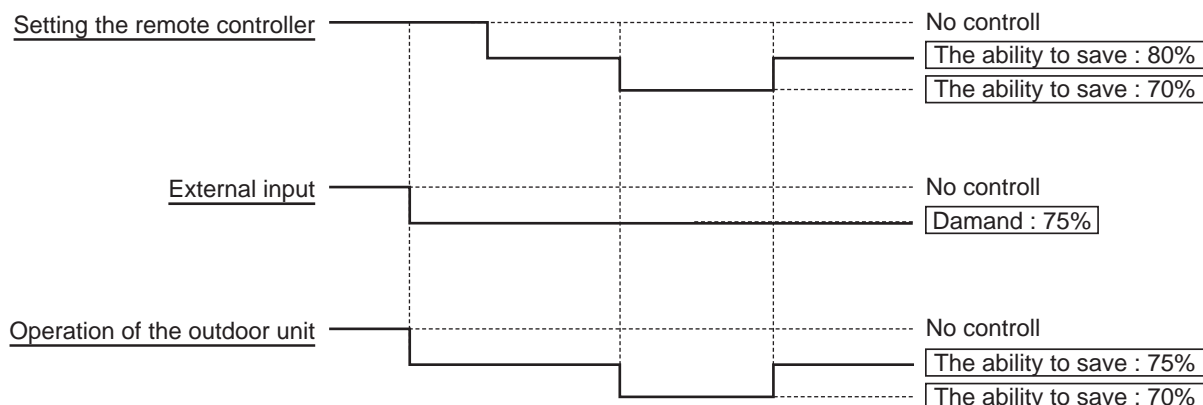

Specifications · Outline demensions

Specifications

<Specifications>

Product size	120(W) × 120(H) × 19(D) mm (4 3/4 × 4 3/4 × 3/4 [in]) (not including the protruding part)	
Net weight	0.25kg (9/16lb.)	
Rated power supply voltage	12V DC (supplied from indoor units)	
Power consumption	0.3W	
Usage environment	Temperature	0 – 40°C (32 - 104°F)
	Humidity	30 – 90%RH (with no dew condensation)
Material	Panel	PMMA
	Main body	PC + ABS

<Connection model>

Unit controlled
Mr.Slim Air conditioners Indoor unit (A controlled)
Multi air conditioners Indoor unit
Multi air conditioners LOSSNAY *1

This manual explains the methods of connecting to the Mr.slim air conditioner.

*1.Connecting via an indoor unit (Direct connection not possible)

<Function>

1. Operation / Display

○:Supported ×:Unsupported A:administrator M:maintenance

Item	Setting	Display	City multi	Mr.slim	Contents	Required password
ON / OFF	○	○	○	○	Press to turn ON / OFF the indoor unit.	–
Operation mode	○	○	○	○	Press the button to go through the operation modes in the order of "Cool, Dry, Fan, Auto, and Heat".	–
Preset temperature	○	○	○	○	Room temperature can be set.The setting temperature range varies with the model of indoor units.	–
					Settable preset temperature range • Cool / Dry : 19 – 30°C • Heat : 17 – 28°C • Auto : 19 – 28°C	–
Fan speed	○	○	○	○	Press the button to go through the fan speeds. The available fan speeds depend on the models of connected indoor units.	–
Vane angle setting	○	○	○		Use to set the vane angle.	–
Louver setting	○	○	○	○	Use to turn ON / OFF the louver. The available louver setting depend on the models of connected indoor units.	–
Ventilation setting	○	○	○	○	For City multi: Select a desired setting from "Off", "Low" and "high". For Mr.Slim: Select a desired setting from "Low" and "high".	–
High power *2	○	○	×	○	Use to reach the comfortable room temperature quickly. Units can be operated in the High-power mode for up to 30 minutes.	–
Auto descending panel *2	○	○	○	○	Use to set the auto descending panel up or down.	–
Backlight	×	○	○	○	When the backlight is off,pressing any button turns the backlight on and it will stay lit for a certain period of time depending on the screen.	–
Main display	○	○	○	○	Use to switch between "Full" and "Basic" modes for the Main display.	–
Clock	○	○	○	○	Use to set the year, month, date, hour or minute.	–
					The set time appears on the main screen (the day also appears). Display of the clock on the main screen can also disabled.	
Clock display	○	○	○	○	Select whether to display the time with a 12-hour display (AM/ PM displayed in front or after time) or a 24-hour display.	–
Room temp display	–	○	○	○	Current room temperature appears here. (Full only)	–
Error display	–	○	○	○	Use to check error information when an error occurs. Error code,error source,refrigerant address,unit model,manufacturing number,contact information (dealer's phone number) can be displayed. The unit model,manufacturing number,and contact information need to registered in advance to be displayed.	–
Filter information	–	○	○	○	Use to check the filter status. The filter sign can be reset.	–

2. Schedule timer

Item	Setting	Display	City multi	Mr.slim	Contents	Required password
Timer	○	○	○	○	Use to set the operation On / Off times. Time can be set in 5-minute increments. *Clock setting is required.	A
		✕	○	○	Use to set the Auto-Off time. Time can be set to a value from 30 to 240 in 10-minute increments.	A
Weekly timer	○	○	○	○	Use to set the weekly operation On / Off times. Up to eight operation patterns can be set for each day. *Clock setting is required. *Not valid when the On/Off timer is enabled.	A
Setting the energy-saving operation schedule *2	○	○	✕	○	Set the start/stop times to operate the units in the energy-save mode for each day of the week, and set the energy-saving rate. Up to four energy-save operation patterns can be set for each day. Time can be set in 5-minute increments. Energy-saving rate can be set to a value from 0% and 90% in 10% increments.	A

3. Restriction

Item	Setting	Display	City multi	Mr.slim	Contents	Required password
Enable / prohibit manual operation	✕	○	○	○	The ON / OFF, operation mode, preset temperature and filter sign reset operations from the centrally controlled settings are prohibited. The corresponding icon lights when prohibited.	A
Operation lock	○	○	○	○	The ON / OFF, mode, set temperature and vane operations can be prohibited.	A
Setting the temp range restriction	○	○	○	○	Use to restrict the preset temperature range.	A
Automatic return to the preset temperature	○	✕	○	○	Use to get the units to operate at the preset temperature after performing energy-save operation for a specified time period. Time can be set to a value from 30 and 120 in 10-minute increments. *This function will not be valid when the preset temperature ranges are restricted.	A
Password	○	✕	○	○	An administrator password (required for setting schedule, etc.) and maintenance password (required for Test run and Function selection, etc.).	A / M

4. Others

Item	Setting	Display	City multi	Mr.slim	Contents	Required password
Contrast	○	○	○	○	Use to adjust screen contrast.	—
Manual vane angle *2	○	✕	○	○	Use to set the vane angle for each vane to a fixed position.	—
Service menu *2	○	○	○	○	Test run, Function setting, Refrigerant leak check, Smooth maintenance, Request code and Error history support.	—
External input	✕	✕	○	○	External input is not allowed	—
External output	✕	✕	○	○	External output is not allowed	—

*2 The supported functions vary depending on the unit model.

Outline dimensions

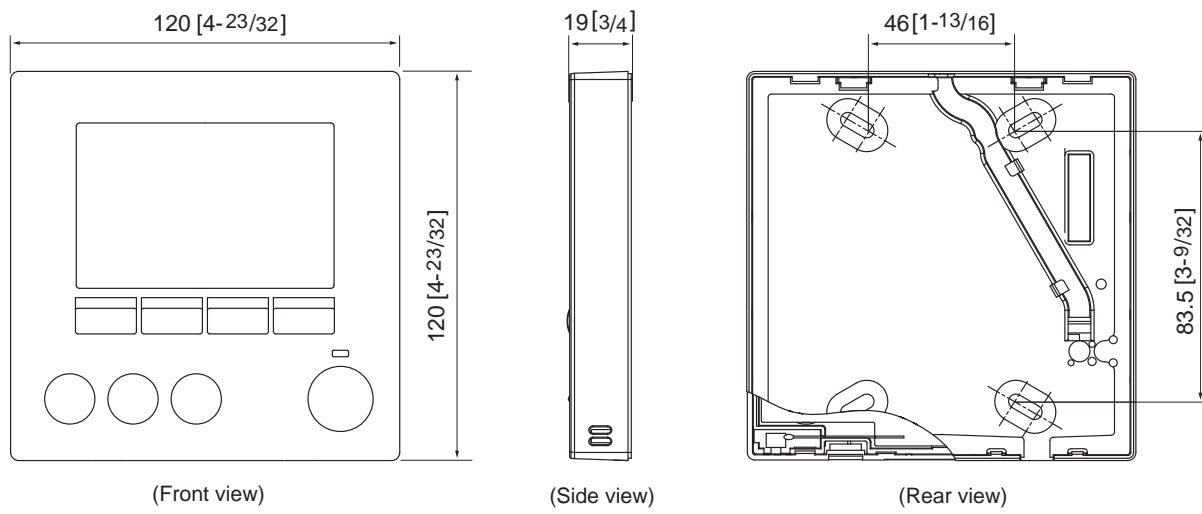

Unit : mm [in.]

List of functions which can / cannot be used in combination

○ : Can be used in combination × : Cannot be used in combination △ : Restricted

	High power	On / Off timer	Auto-off timer	Weekly timer	Temperature range	Operation lock	Auto return	Energy saving schedule	Night setback
High power		○	○	○	○	△2	○	△1	○
On/Off timer	○		○	× 1	○	○	○	○	△3
Auto-off timer	○	○		○	○	○	○	○	△4
Weekly timer	○	× 1	○		○	○	○	○	△5
Temperature range	○	○	○	○		○	× 2	○	△6
Operation lock	△2	○	○	○	○		○	○	○
Auto return	○	○	○	○	× 2	○		○	△7
Energy saving schedule	△1	○	○	○	○	○	○		○
Night setback	○	△3	△4	△5	△6	○	△7	○	

△1: This function is enabled after completing the high power operation because the high power operation has the higher priority.

△2: This function cannot be operated if some operation is locked.

△3: Night setback function cannot be used when the unit is in operation by On / Off timer setting.

△4: Auto-off function cannot be used for Night setback operation.

△5: Night setback function cannot be used when the unit is in operation by Weekly timer setting.

△6: Temperature range setting cannot be used for Night setback operation.

△7: Auto return function cannot be used for Night setback operation.

×1: Weekly timer setting is not effective because On / Off timer has the higher priority.

×2: Auto return function cannot be used because Temperature range setting has the higher priority.



The Shizuoka Works acquired environmental management system standard ISO 14001 certification.

The ISO 14000 series is a set of standards applying to environmental protection set by the International Standard Organization (ISO).

 **MITSUBISHI ELECTRIC CORPORATION**

HEAD OFFICE: TOKYO BLDG. , 2-7-3, MARUNOUCHI, CHIYODA-KU, TOKYO 100-8310, JAPAN