

**We Do Not Recommend**  
These Freeze Relief Setups  
(Pipe Size Listed On Each Pipe)

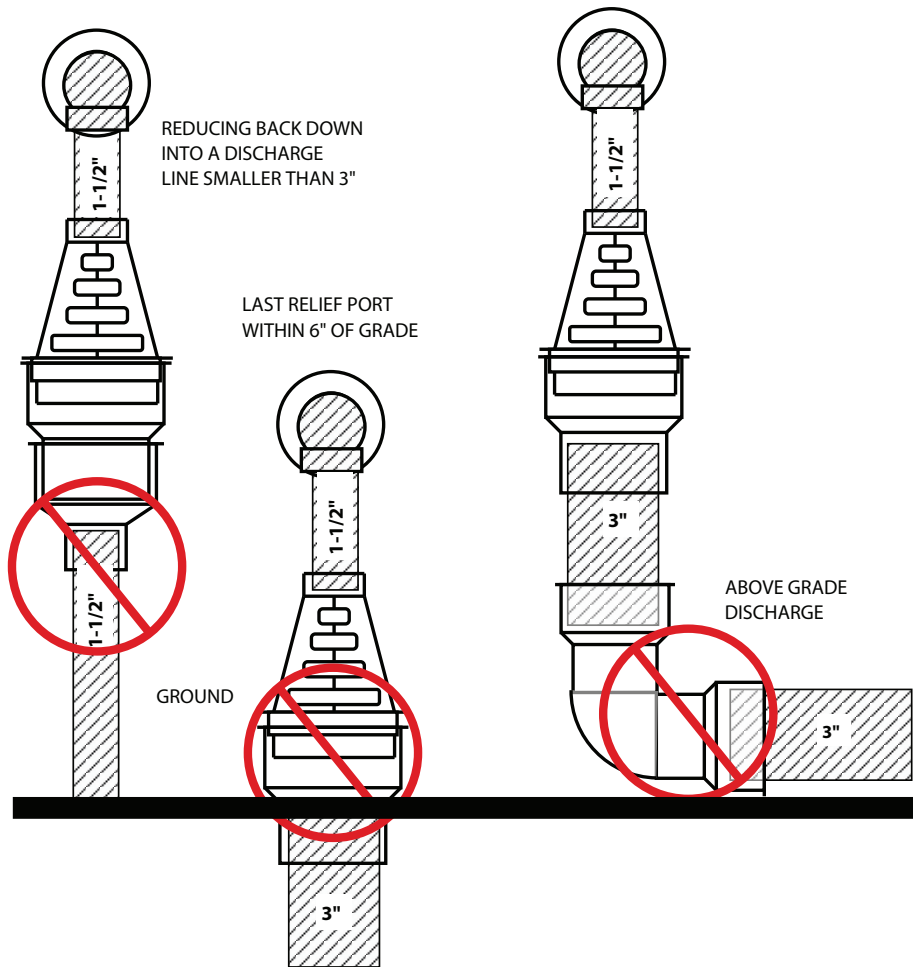

**FREEZE RELIEF**

THE FREEZE RELIEF KIT INCLUDES ONE (1) EACH:

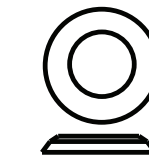

1-1/2" COLLAR

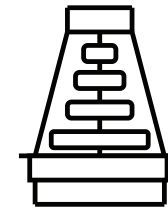

FREEZE RELIEF

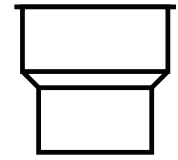

4" TO 3" REDUCER

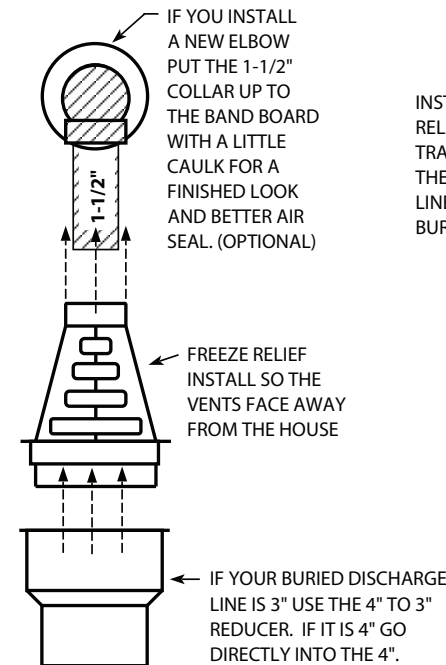

INSTALL FREEZE RELIEF IN-LINE AS THE TRANSITION BETWEEN THE 1-1/2" SUMP PUMP LINE AND THE 3" OR 4" BURIED DISCHARGE LINE

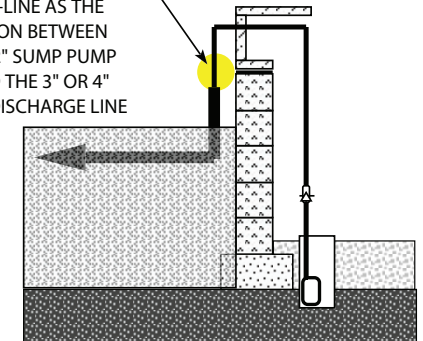

RECOMMENDED FREEZE RELIEF  
SET UP OPTIONS

(Pipe size listed on each pipe)

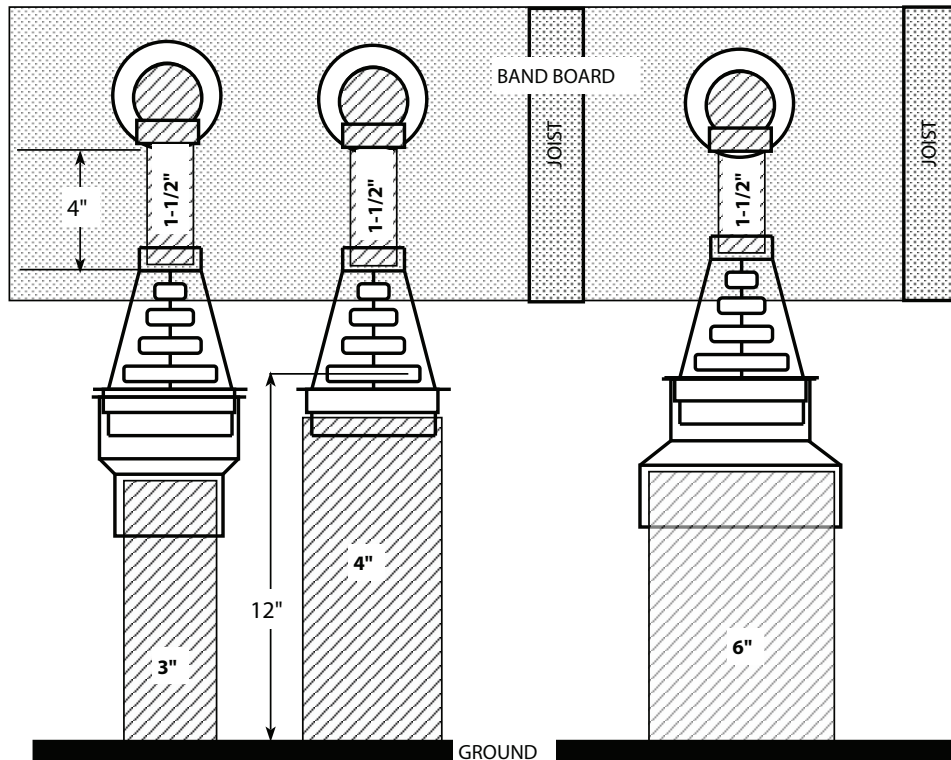

FREEZE RELIEF IS DESIGNED TO GIVE YOUR SUMP PUMP SYSTEM A WAY FOR WATER TO ESCAPE IN CASE THE BURIED DISCHARGE LINE FREEZES. THE MORE DISTANCE BETWEEN THE FREEZE RELIEF VENTS AND THE GROUND THE BETTER.

WE RECOMMEND INSTALLING THE TOP OF THE FREEZE RELIEF ABOUT 4" BELOW ELBOW. (WHY? BECAUSE ANYTHING SHORTER IS TOO HARD.) AND, INSTALLING THE FREEZE RELIEF WITH AT LEAST 12" CLEARANCE ABOVE THE GROUND. (WHY? BECAUSE 12" IS BETTER THAN 10," AND 10" IS BETTER THAN 8.")

