

FRONT WIND BAFFLE WB-PA3 / WB-PA4 / WB-PA5

DESIGNED FOR P-SERIES AND PUMY OUTDOOR UNITS ONLY

Job Name:	Date:
System Reference:	



WB-PA3 / WB-PA4 / WB-PA5

GENERAL FEATURES

- WB-Series Wind Baffles allow P-Series outdoor units to operate at full capacity to 0° F DB cooling.
- Allows PUMY outdoor units to operate to 23° F DB cooling.
- Prevents wind from reversing outdoor fan rotation when un-energized.
- Durable, low maintenance construction.
- WB-PA3 Wind Baffle allows PUMY-P-NKMU1 outdoor units to operate down to 5° F DB at 100% capacity in cooling mode and down to -13° F DB in heating mode with a de-rate.

PLEASE NOTE

- Install outdoor units with the back surface facing wall side to eliminate the effects of external wind.
- Outdoor units should not be installed in an orientation or site where the wind blows directly at the back of the unit.
- Wind baffle should not be used where there is any obstacle at either side or above the outdoor unit as the discharged air will be blocked.

SPECIFICATIONS

		WB-PA3	WB-PA4	WB-PA5
Exterior	Color	Matches P-Series Outdoor Unit		
	Surface Treatment	Polyester Powder Paint		
	Material	Alloy Hot-Dip Zinc Coated Carbon Steel Sheet		
Weight		8 Lbs. 8 Oz.	7 Lbs. 9 oz	8 Lbs. 5 Oz.

MODEL REQUIRED PER OUTDOOR UNIT

UNIT MODEL	Type and Quantity		
	WB-PA3	WB-PA4	WB-PA5
PUY/Z-A24NHA4			1
PUY/Z-A30NHA4			1
PUY/Z-A36NHA4			1
PUY/Z-A42NHA4			2
PUY/Z-A42NHA5			2
PUZ-HA30NHA4			2
PUZ-HA36NHA4			2
PUZ-HA30NHA5			2
PUZ-HA36NHA5			2
PUZ-HA42NKA	2		
PUMY-P36NHMU			2
PUMY-P36NKMU1	2		
PUMY-P48NHMU			2
PUMY-P48NKMU1	2		
PUMY-P60NKMU1	2		
PUY/Z-A24NHA6			1
PUY/Z-A30NHA6			1
PUY/Z-A36NHA6			1
PUY/Z-A42NHA6			2
PUY/Z-A12NKA7		1	
PUY/Z-A18NKA7		1	
PUY/Z-A24NHA7			1
PUY/Z-A30NHA7			1
PUY/Z-A36NKA7	2		
PUY/Z-A42NKA7	2		

DIMENSIONS: WB-PA3

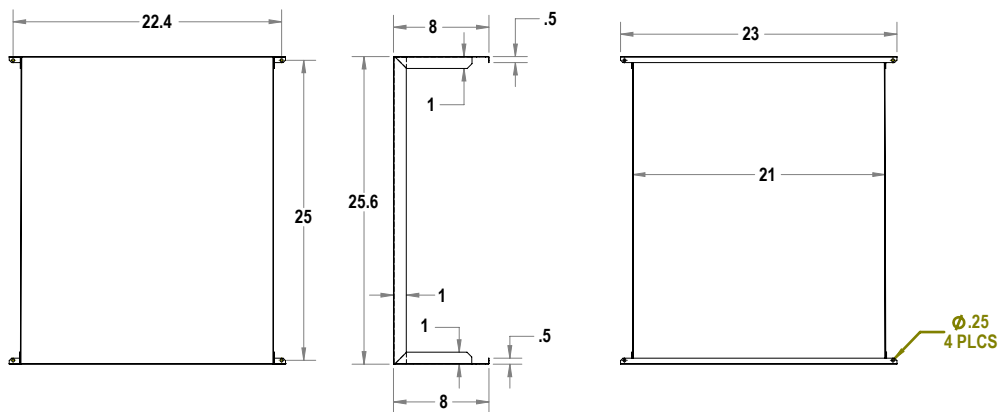
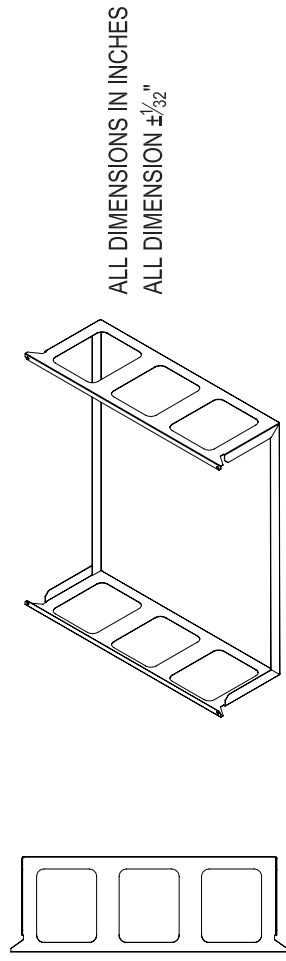
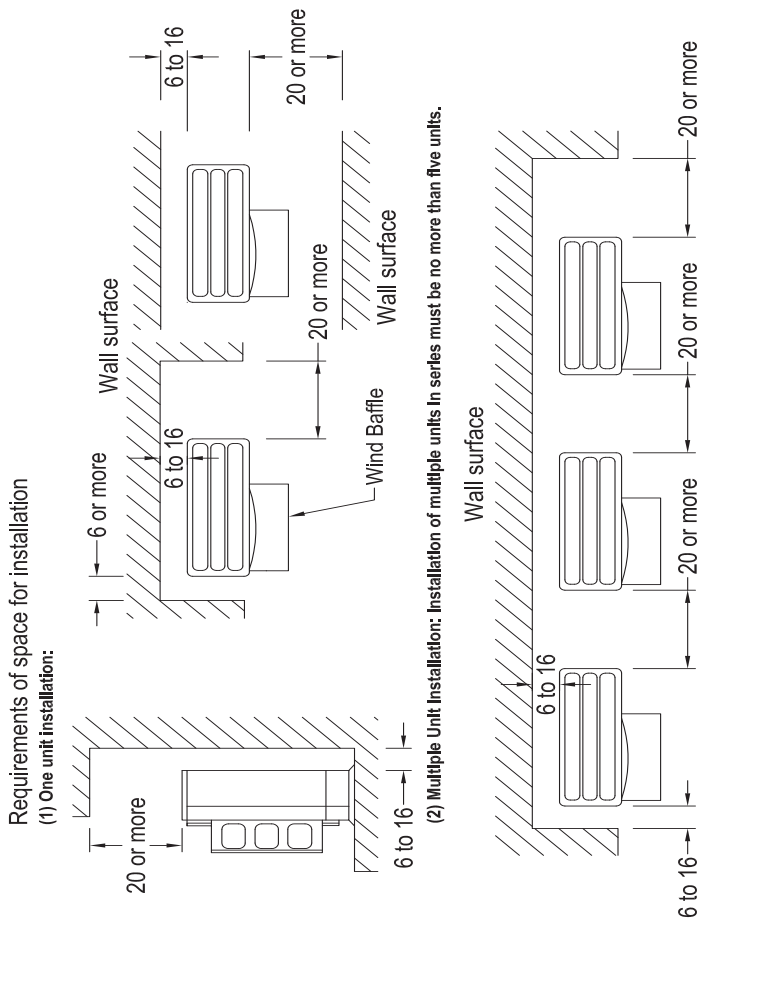

DIMENSIONS: WB-PA4

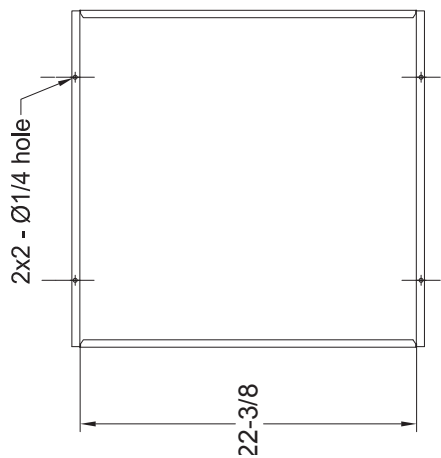
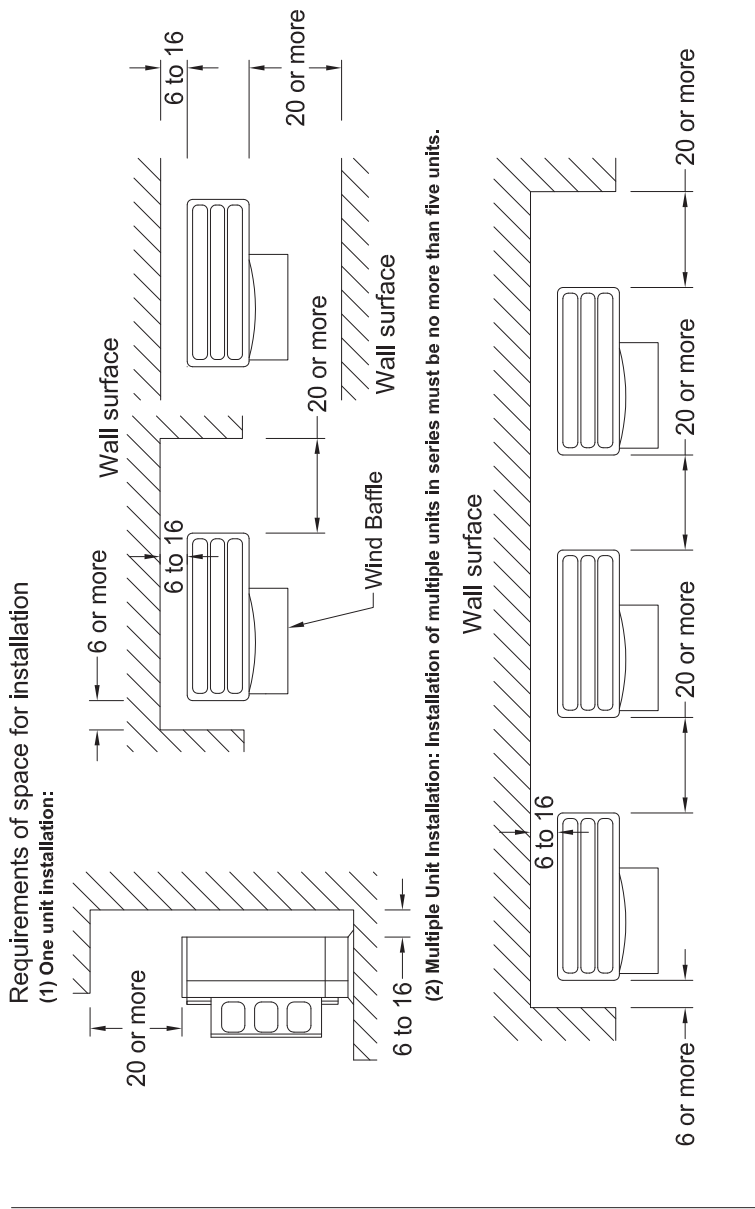

Back View

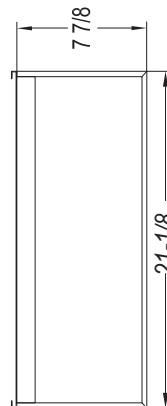

Side View

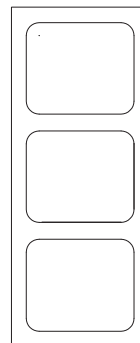

Top View

ALL DIMENSIONS IN INCHES
ALL DIMENSIONS $\pm 1/32$ "

DIMENSIONS: WB-PA5

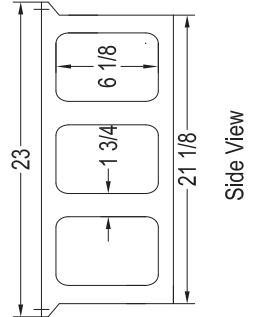
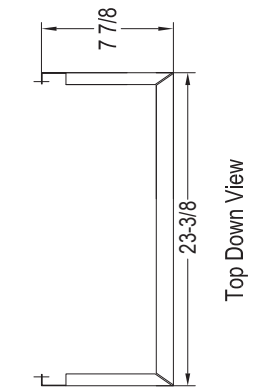
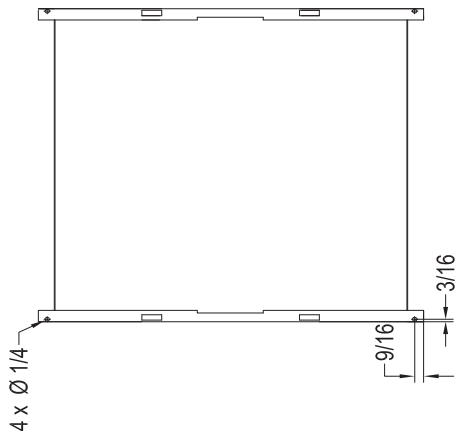
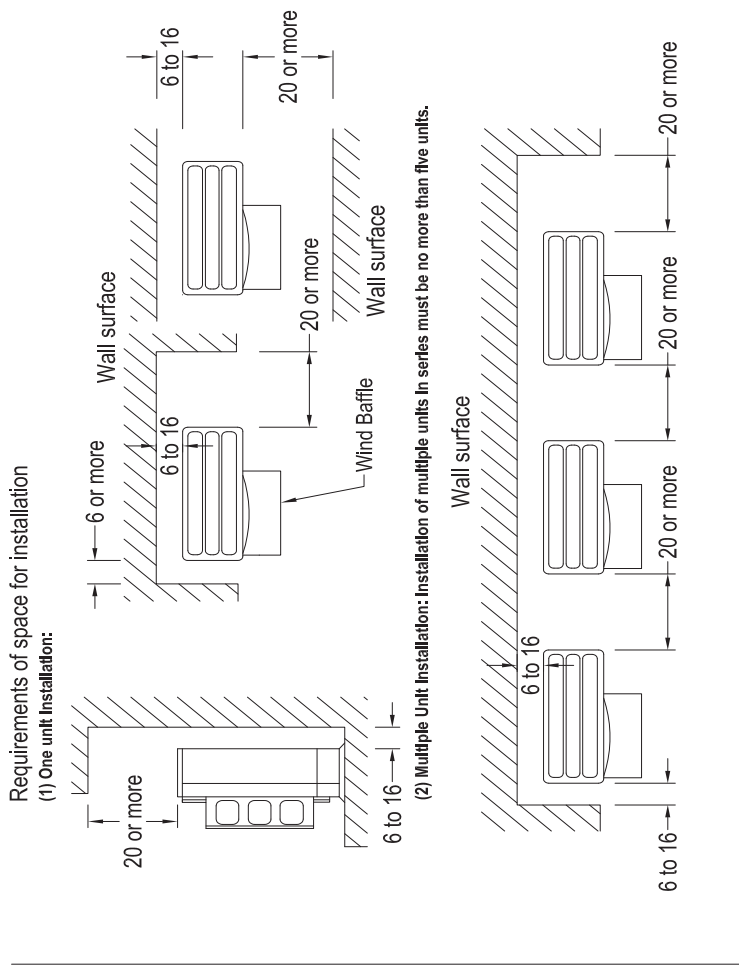

ALL DIMENSIONS IN INCHES
ALL DIMENSION $\pm \frac{1}{32}$ "

Manufactured for MITSUBISHI ELECTRIC US, INC.
1340 Satellite Boulevard, Suwanee, GA 30024
Toll Free: 800-433-4822 www.mehvac.com