

Revision A:

• 3. SPECIFICATION and 4. OUTLINES AND DIMENSIONS have been modified.

Please void OBH752.

INDOOR UNIT

**No. OBH752
REVISED EDITION-A**

SERVICE MANUAL

Models

MFZ-KJ09NA - U1

MFZ-KJ12NA - U1

MFZ-KJ15NA - U1

MFZ-KJ18NA - U1

**Outdoor unit service manual
MUFZ-KJ•NAHZ Series (OBH753)
MXZ-C•NA, MXZ-C•NAHZ Series
(OBH702, OCH573)**

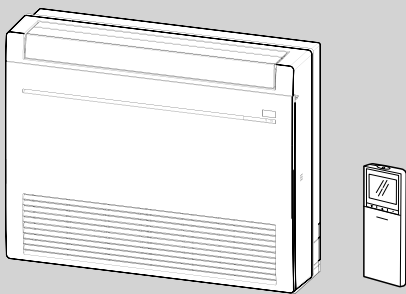

CONTENTS

1. TECHNICAL CHANGES	3
2. PART NAMES AND FUNCTIONS	4
3. SPECIFICATION	5
4. OUTLINES AND DIMENSIONS	7
5. WIRING DIAGRAM	8
6. REFRIGERANT SYSTEM DIAGRAM	9
7. SERVICE FUNCTIONS	10
8. MICROPROCESSOR CONTROL	12
9. TROUBLESHOOTING	21
10. DISASSEMBLY INSTRUCTIONS	36

PARTS CATALOG (OBB752)

NOTE:

- This service manual describes technical data of the indoor units.
- RoHS compliant products have <G> mark on the spec name plate.
For servicing of RoHS compliant products, refer to the RoHS Parts List.

Use the specified refrigerant only

Never use any refrigerant other than that specified.

Doing so may cause a burst, an explosion, or fire when the unit is being used, serviced, or disposed of.

Correct refrigerant is specified in the manuals and on the spec labels provided with our products.

We will not be held responsible for mechanical failure, system malfunction, unit breakdown or accidents caused by failure to follow the instructions.

Revision A:

- 3. SPECIFICATION and 4. OUTLINES AND DIMENSIONS have been modified.

MFZ-KJ09NA-^{U1}

MFZ-KJ12NA-^{U1}

MFZ-KJ15NA-^{U1}

MFZ-KJ18NA-^{U1}

1. New model

2

PART NAMES AND FUNCTIONS

MFZ-KJ09NA MFZ-KJ12NA MFZ-KJ15NA MFZ-KJ18NA

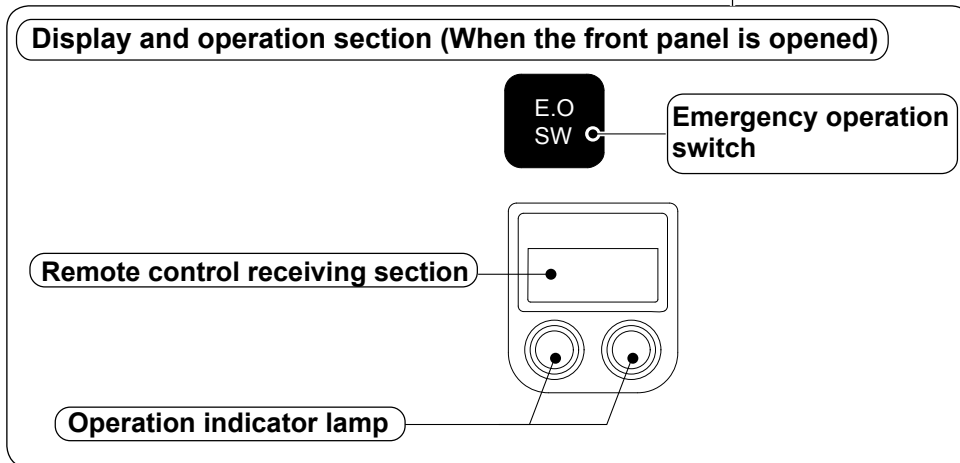
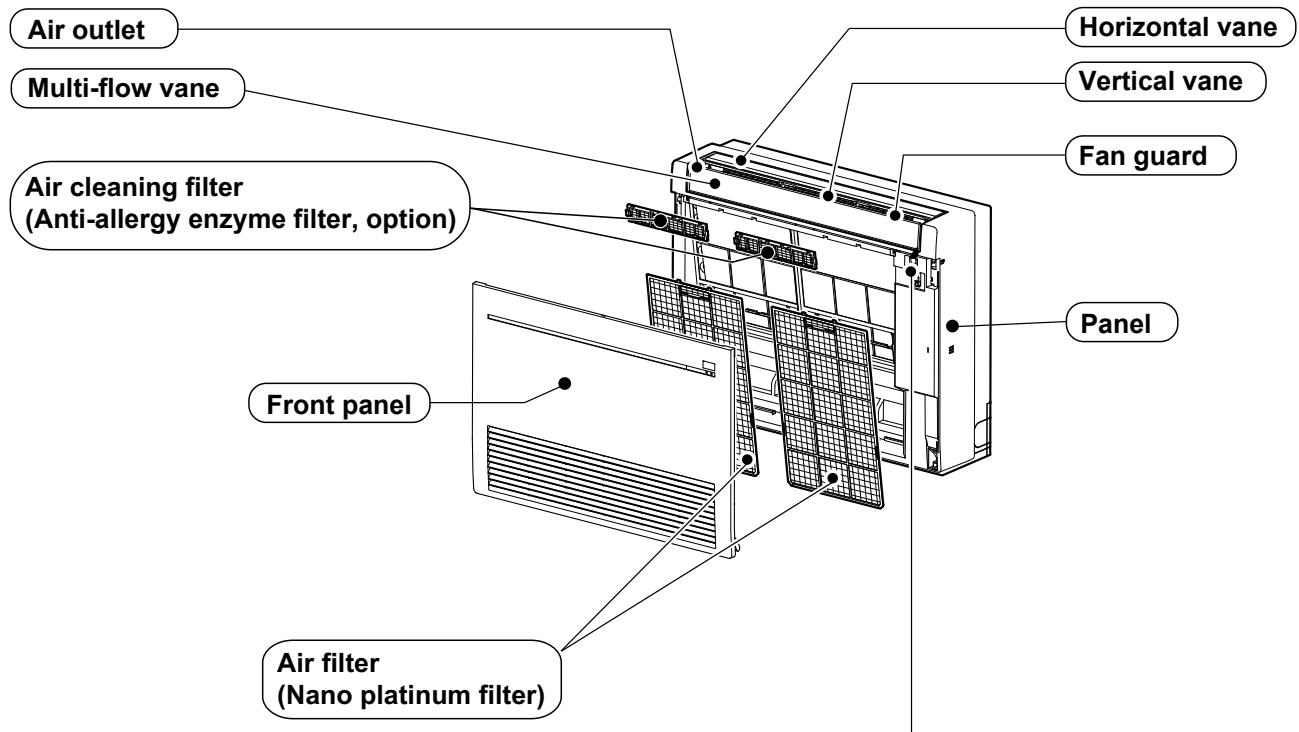

ACCESSORIES

		MFZ-KJ09NA	MFZ-KJ12NA	MFZ-KJ15NA	MFZ-KJ18NA
①	Drain hose		1		
②	Remote controller holder		1		
③	Fixing screw for ② 3.5 x 16 mm (Black)		2		
④	Pipe cover		1		
⑤	Band		2		
⑥	Battery (AAA) for remote controller		2		
⑦	Indoor unit mounting bracket		1		
⑧	Fixing screw for ⑦ 4 x 25 mm		5		
⑨	Wood screw for the indoor unit fixation		4		
⑩	Washer of ⑨		4		
⑪	Felt tape (Used for left or left-rear piping)		1		
⑫	Wireless remote controller		1		

3

SPECIFICATION

1. Single connection

Indoor model			MFZ-KJ09NA	MFZ-KJ12NA	MFZ-KJ15NA	MFZ-KJ18NA
Power supply	V, phase, Hz		208/230, 1, 60			
Max. fuse size (time delay)/ Disconnect switch	A		15		20	
Airflow Super High - High - Med. - Low - Quiet	COOL Dry (Wet)	CFM	417 - 360 - 272 - 198 - 138 (354 - 306 - 231 - 168 - 117)		431 - 392 - 311 - 254 - 198 (366 - 333 - 264 - 216 - 168)	491 - 420 - 328 - 254 - 198 (417 - 357 - 279 - 216 - 168)
	HEAT Dry	CFM	417 - 328 - 254 - 191 - 138		470 - 399 - 328 - 268 - 212	
Sound level Super High - High - Med. - Low - Quiet	Cooling	dB (A)	46 - 41 - 34 - 27 - 21		47 - 43 - 38 - 33 - 28	50 - 45 - 39 - 33 - 28
	Heating	dB (A)	46 - 40 - 34 - 27 - 21		49 - 45 - 40 - 35 - 29	49 - 45 - 40 - 35 - 29
Cond. drain connection O.D.	in.		5/8			
Dimensions	W	in.	29-17/32			
	D		8-15/32			
	H		23-5/8			
Weight	lb.		33			
External finish			White			
Control voltage (by built-in transformer)			12 - 24 VDC			

NOTE: Test conditions are based on ARI 210/240.

2. Multi connection

Indoor model			MFZ-KJ09NA	MFZ-KJ12NA	MFZ-KJ15NA	MFZ-KJ18NA
Power supply	V, phase, Hz		208/230, 1, 60			
Max. fuse size (time delay)/ Disconnect switch	A		15		20	
Airflow Super High - High - Med. - Low - Quiet	COOL Dry (Wet)	CFM	275 - 251 - 208 173 - 138 (234 - 213 - 177 - 147 - 117)		374 - 328 - 282 - 237 - 198 (318 - 279 - 240 - 201 - 168)	
	HEAT Dry	CFM	343 - 219 - 180 - 159 - 138		470 - 325 - 290 - 254 - 212	
Sound level Super High - High - Med. - Low - Quiet	Cooling	dB (A)	38 - 34 - 30 - 25 - 21		43 - 40 - 36 - 31 - 28	
	Heating	dB (A)	41 - 32 - 27 - 24 - 21		49 - 39 - 36 - 34 - 29	
Cond. drain connection O.D.	in.		5/8			
Dimensions	W	in.	29-17/32			
	D		8-15/32			
	H		23-5/8			
Weight	lb.		33			
External finish			White			
Control voltage (by built-in transformer)			12 - 24 VDC			

NOTE: Test conditions are based on ARI 210/240.

3-1. OPERATING RANGE

(1) POWER SUPPLY

	Rated voltage	Guaranteed voltage (V)
Indoor unit	208/230 V 1 phase 60 Hz	<p>Min. 187 208 230 Max. 253</p>

(2) OPERATION

Mode	Condition	Intake air temperature (°F)			
		Indoor		Outdoor	
		DB	WB	DB	WB
Cooling	Standard temperature	80	67	95	—
	Maximum temperature	90	73	115	—
	Minimum temperature	67	57	14	—
	Maximum humidity	78%		—	
Heating	Standard temperature	70	60	47	43
	Maximum temperature	80	67	75	65
	Minimum temperature	70	60	-13	-14

3-2. OUTLET AIR SPEED AND COVERAGE

1. Single connection

Model	Mode	Function	Airflow (CFM)	Air speed (ft./s.)	Coverage (ft.)
MFZ-KJ09NA MFZ-KJ12NA	HEAT	Dry	417	20.3	29.6
	COOL	Dry	417	20.3	29.6
		Wet	354	17.2	25.3
MFZ-KJ15NA	HEAT	Dry	470	22.9	33.3
	COOL	Dry	431	21.0	30.6
		Wet	366	17.8	26.2
MFZ-KJ18NA	HEAT	Dry	470	22.9	33.3
	COOL	Dry	491	23.9	34.8
		Wet	417	20.3	29.7

- The air coverage is the figure up to the position where the air speed is 1 ft./s., when air is blown out horizontally from the unit properly at the High speed position. The coverage should be used only as a general guideline since it varies according to the size of the room and furniture arranged inside the room.

2. Multi connection

Model	Mode	Function	Airflow (CFM)	Air speed (ft./s.)	Coverage (ft.)
MFZ-KJ09NA MFZ-KJ12NA	HEAT	Dry	343	16.7	24.5
	COOL	Dry	275	13.4	19.8
		Wet	234	11.4	16.9
MFZ-KJ15NA MFZ-KJ18NA	HEAT	Dry	470	22.9	33.3
	COOL	Dry	374	18.2	26.7
		Wet	318	15.5	22.8

4

OUTLINES AND DIMENSIONS

MFZ-KJ09NA MFZ-KJ12NA MFZ-KJ15NA MFZ-KJ18NA

Unit: inch

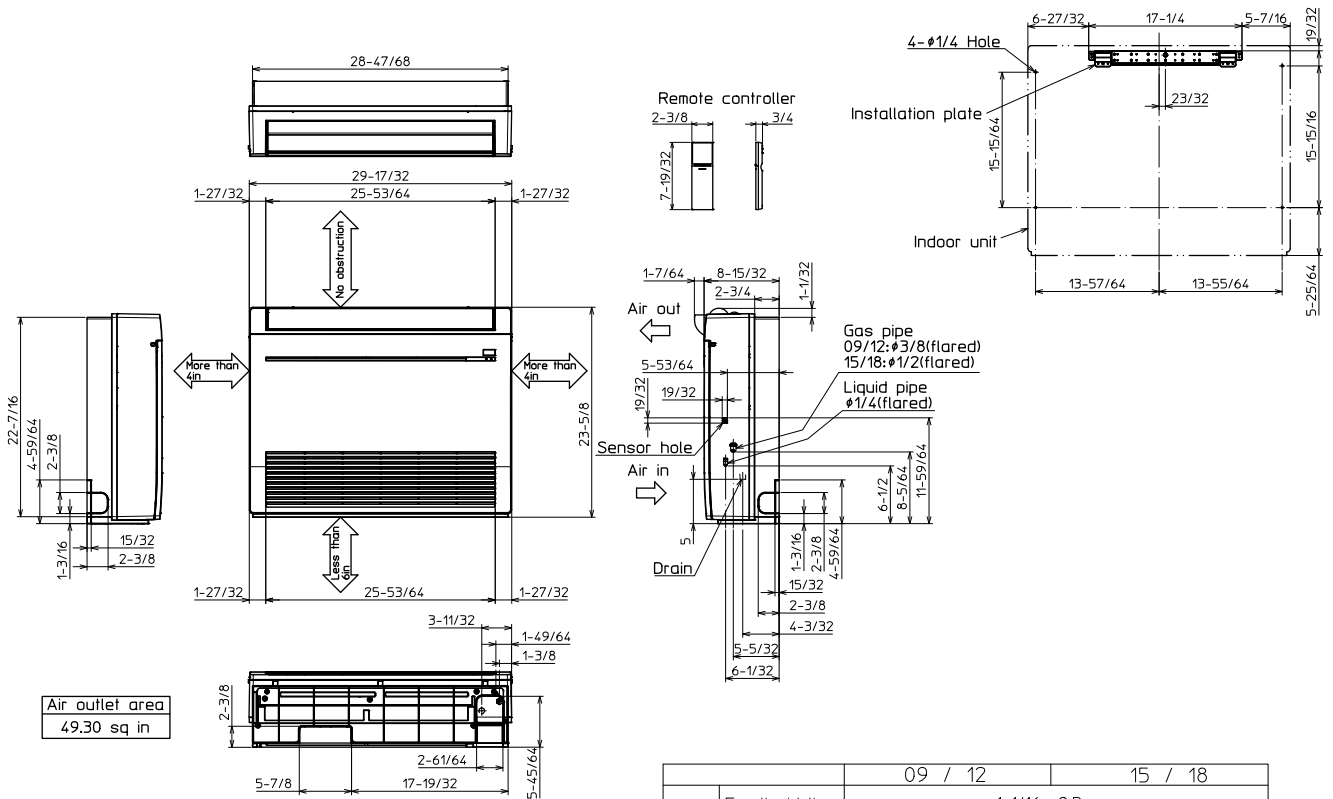

Air outlet area
49.30 sq in

		09 / 12	15 / 18
Pipe cover	For liquid line	1-1/16 O.D	
	For gas line	1-1/16 O.D	1-7/32 O.D
Piping	Liquid line	Flared connection 1/4	
	Gas line	Flared connection 3/8	Flared connection 1/2
Drain hose	Heat insulator	Connection point	Effective length
	1-9/64 O.D	5/8 O.D	13-25/32 (case of right backward piping)

5

WIRING DIAGRAM

MFZ-KJ09NA MFZ-KJ12NA MFZ-KJ15NA MFZ-KJ18NA

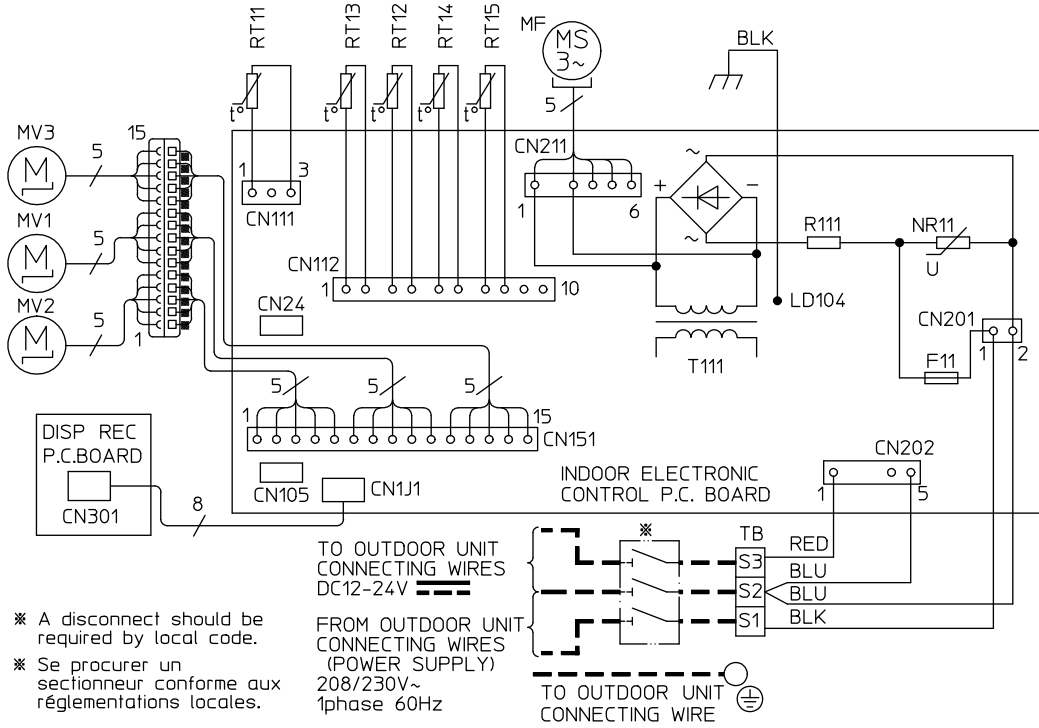

- * A disconnect should be required by local code.
- * Se procurer un sectionneur conforme aux réglementations locales.

SYMBOL	NAME
MF	FAN MOTOR
MV1	HORIZONTAL VANE MOTOR (FRONT)
MV2	HORIZONTAL VANE MOTOR (BACK)
MV3	MULTI-FLOW VANE MOTOR
F11	FUSE (T3.15AL250V)
T11	TRANSFORMER
TB	TERMINAL BLOCK
RT11	ROOM TEMP. THERMISTOR
RT12	COIL TEMP. THERMISTOR(MAIN1)
RT13	COIL TEMP. THERMISTOR(SUB)
RT14	COIL TEMP. THERMISTOR(MAIN2)
RT15	COIL TEMP. THERMISTOR(MAIN3)
NR11	VARISTOR
R11	RESISTOR

6

REFRIGERANT SYSTEM DIAGRAM

MFZ-KJ09NA MFZ-KJ12NA MFZ-KJ15NA MFZ-KJ18NA

Unit: inch (mm)

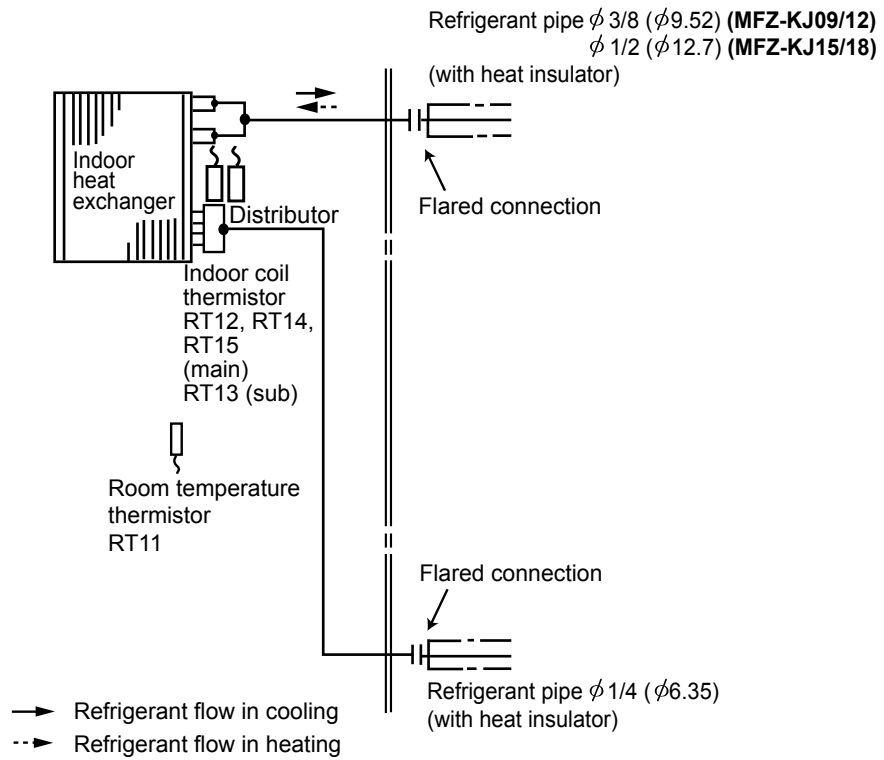

MFZ-KJ09NA MFZ-KJ12NA MFZ-KJ15NA MFZ-KJ18NA

7-1. TIMER SHORT MODE

- For service, the following set time can be shortened by bridging the timer short mode point on the electronic control P.C. board. (Refer to 9-7.)
- The set time for the ON/OFF timer can be reduced to 1 second for each minute.
- After the breaker is turned on, the time for starting the compressor, which normally takes 3 minutes, can be reduced to 3 seconds. Restarting the compressor, which takes 3 minutes, cannot be reduced.

7-2. HOW TO SET REMOTE CONTROLLER EXCLUSIVELY FOR A PARTICULAR INDOOR UNIT

A maximum of 4 indoor units with wireless remote controllers can be used in a room.

To operate the indoor units individually with each remote controller, assign a number to each remote controller according to the number of the indoor unit.

This setting can be set only when all the following conditions are met:

- The remote controller is powered OFF.
- Weekly timer is not set.
- Weekly timer is not being edited.

1. How to modify the electronic control P.C. board

Turn OFF the power supply before modification. To assign a number to each indoor unit, cut off "JR05" and "JR06" on the electronic control P.C. board as shown in Table 1. (Refer to 9-7.)

Table 1

	JR05	JR06
Unit No. 1	No modification	No modification
Unit No. 2	Cut off JR05	No modification
Unit No. 3	No modification	Cut off JR06
Unit No. 4	Cut off JR05	Cut off JR06

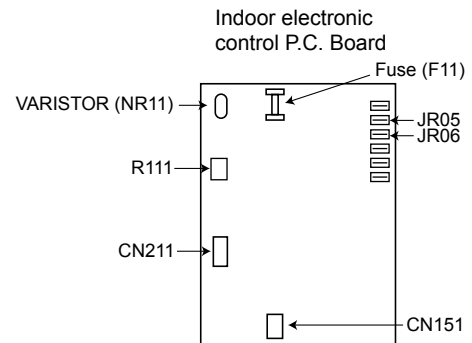

2. How to set the remote controller

- (1) Hold down **[1~4]** button on the remote controller for 2 seconds to enter the pairing mode.
- (2) Press **[1~4]** button again and assign a number to each remote controller.
Each press of **[1~4]** button advances the number in the following order: 1 → 2 → 3 → 4.
- (3) Press **[EDIT/SEND SET]** button to complete the pairing setting.

After the setting, turn ON the power supply and with the remote controller headed towards the indoor unit, press the STOP/OPERATE (OFF/ON) button. If 1 or 2 beeps are heard from the indoor unit, the setting is completed correctly. The remote controller that first sends a signal to an indoor unit will be regarded as the remote controller for the indoor unit.

Once they are set, the indoor unit will only receive the signal from the assigned remote controller afterwards.

7-3. AUTO RESTART FUNCTION

When the indoor unit is controlled with the remote controller, the operation mode, the set temperature, and the fan speed are memorized by the indoor electronic control P.C. board. "AUTO RESTART FUNCTION" automatically starts operation in the same mode just before the shutoff of the main power.

Operation

- ① If the main power has been cut, the operation settings remain.
- ② After the power is restored, the unit restarts automatically according to the memory.
(However, it takes at least 3 minutes for the compressor to start running.)

How to disable "AUTO RESTART FUNCTION"

- ① Turn off the main power for the unit.
- ② Cut the Jumper wire to JR77 on the indoor electronic control P.C. board. (Refer to 9-7.)

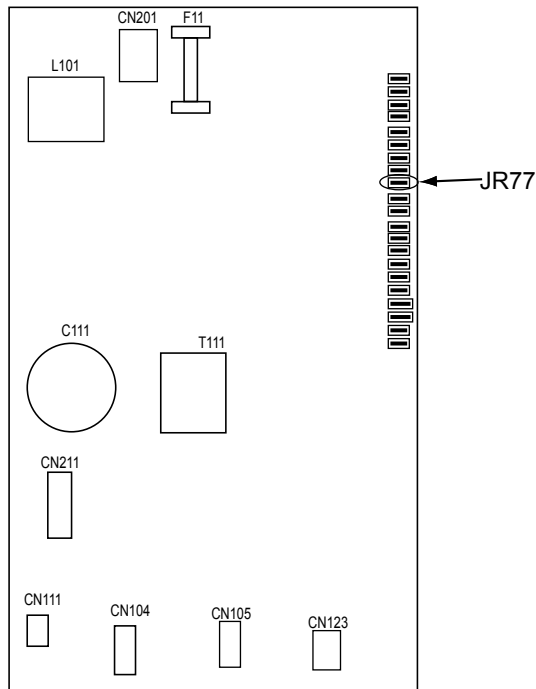

NOTE:

- The operation settings are memorized when 10 seconds have passed after the indoor unit was operated with the remote controller.
- If main power is turned OFF or a power failure occurs while AUTO START/STOP timer is active, the timer setting is cancelled.
- If the unit has been off with the remote controller before power failure, the auto restart function does not work as the power button of the remote controller is off.
- To prevent breaker OFF due to the rush of starting current, systematize other home appliance not to turn ON at the same time.
- When some air conditioners are connected to the same supply system, if they are operated before power failure, the starting current of all the compressors may flow simultaneously at restart. Therefore, the special counter measures are required to prevent the main voltage-drop or the rush of the starting current by adding to the system that allows the units to start one by one.

MFZ-KJ09NA MFZ-KJ12NA MFZ-KJ15NA MFZ-KJ18NA

WIRELESS REMOTE CONTROLLER

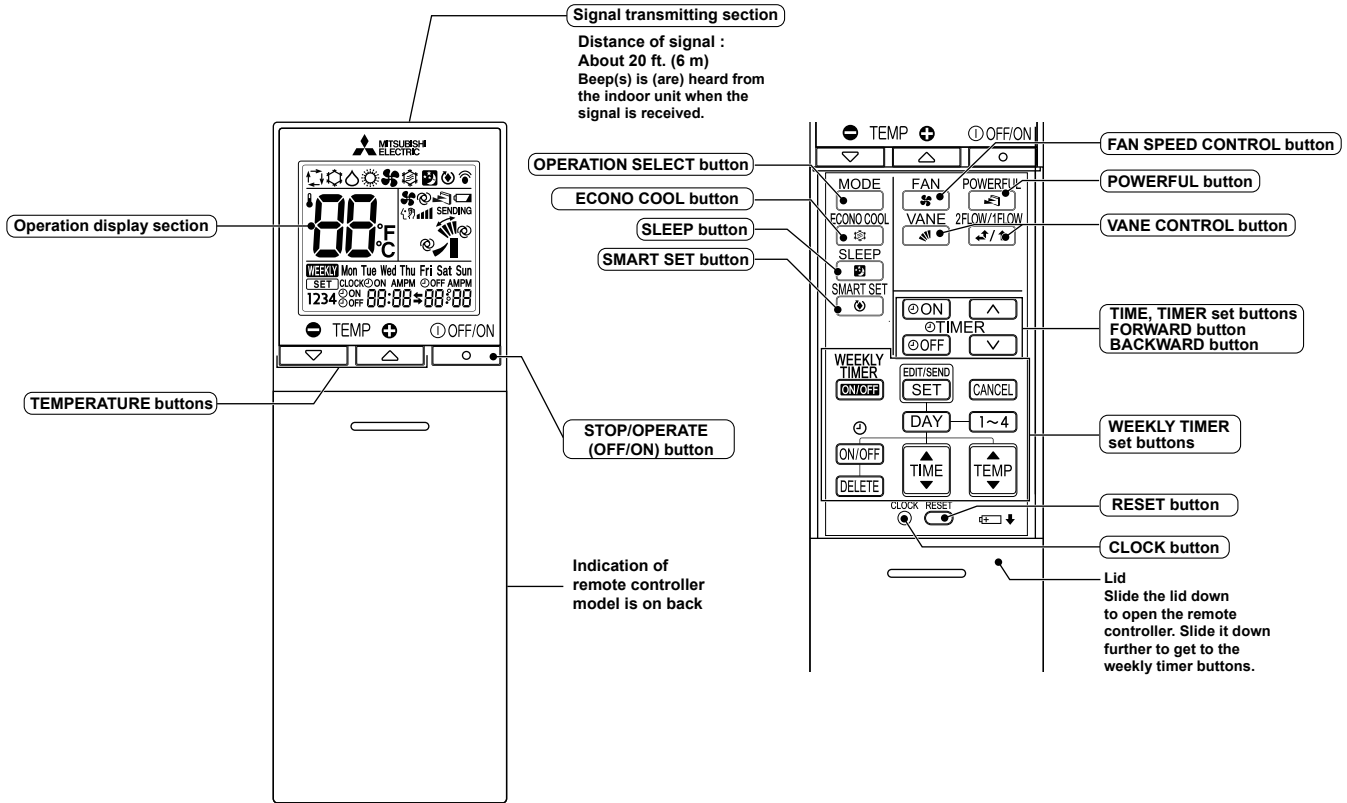

NOTE: Last setting will be stored after the unit is turned OFF with the remote controller. Indoor unit receives the signal of the remote controller with beeps.

INDOOR UNIT DISPLAY SECTION

Operation Indicator lamp

The operation indicator at the right side of the indoor unit indicates the operation state.

•The following indication applies regardless of shape of the indication.

Indication	Operation state	Room temperature
● ●	The unit is operating to reach the set temperature	About 4 °F (2°C) or more away from set temperature
● ○	The room temperature is approaching the set temperature	About 2 to 4 °F (1 to 2°C) from set temperature
● ☉	Standby mode (only during multi system operation)	—

- Lighted
- ☉ Blinking
- Not lighted

8-1. COOL (❄️) OPERATION

- (1) Press STOP/OPERATE (OFF/ON) button.
OPERATION INDICATOR lamp of the indoor unit turns on with a beep tone.
- (2) Select COOL mode with OPERATION SELECT button.
- (3) Press TEMPERATURE buttons TEMP \ominus or \oplus button to select the desired temperature. The setting range is 61 - 88°F (16 - 31°C).

1. Coil frost prevention

The compressor operational frequency is controlled by the temperature of the indoor heat exchanger to prevent the coil from frosting.

When the temperature of indoor heat exchanger becomes too low, the coil frost prevention mode works.

The indoor fan operates at the set speed and the compressor stops. This mode continues until the temperature of indoor heat exchanger rises.

2. Low outside temperature operation

When the outside temperature is lower, low outside temperature operation starts, and the outdoor fan slows or stops.

3. Indoor fan speed control

When the thermostat turns OFF, the indoor fan operates at the setting fan speed.

8-2. DRY (☀️) OPERATION

- (1) Press STOP/OPERATE (OFF/ON) button.
OPERATION INDICATOR lamp of the indoor unit turns on with a beep tone.
- (2) Select DRY mode with OPERATION SELECT button.
- (3) The set temperature is determined from the initial room temperature.

1. Coil frost prevention

Coil frost prevention works the same way as that in COOL mode. (8-1.1.)

2. Low outside temperature operation

Low outside temperature operation works the same way as that in COOL mode. (8-1.2.)

3. Indoor fan speed control

Indoor fan speed control works the same way as that in COOL mode. (8-1.3.)

However in AUTO setting, the fan speed changes.

8-3. FAN (🌀) OPERATION

- (1) Press STOP/OPERATE (OFF/ON) button.
OPERATION INDICATOR lamp of the indoor unit turns on with a beep tone.
- (2) Select FAN mode with OPERATION SELECT button.
- (3) Select the desired fan speed. When AUTO, it becomes Low.

Only indoor fan operates.

Outdoor unit does not operate.

NOTE: Temperature cannot be set during FAN mode.

8-4. HEAT (🔥) OPERATION

- (1) Press STOP/OPERATE (OFF/ON) button.
OPERATION INDICATOR lamp of the indoor unit turns on with a beep tone.
- (2) Select HEAT mode with OPERATION SELECT button.
- (3) Press TEMPERATURE buttons TEMP \ominus or \oplus button to select the desired temperature. The setting range is 61 - 88°F (16 - 31°C).

1. Cold air prevention control

When the compressor is not operating or is starting, and the temperature of indoor heat exchanger and/or the room temperature is low or when defrosting is being done, the indoor fan will stop or rotate in Very Low speed.

2. High pressure protection

The compressor operational frequency is controlled by the temperature of the indoor heat exchanger to prevent the condensing pressure from increasing excessively.

When the temperature of indoor heat exchanger becomes too high, the high pressure protection works.

This mode continues until the temperature of indoor heat exchanger falls.

3. Defrosting

Defrosting starts when the temperature of outdoor heat exchanger becomes too low.

The compressor stops once, the indoor/outdoor fans stop, the 4-way valve reverses, and the compressor re-starts.

This mode continues until the temperature of outdoor heat exchanger rises or the fixed time passes.

8-5. AUTO CHANGE OVER ... AUTO MODE OPERATION

Once desired temperature is set, unit operation is switched automatically between COOL and HEAT operation.

1. Mode selection

(1) Initial mode

At first indoor unit operates only indoor fan with outdoor unit OFF for 3 minutes to detect present room temperature. Following the conditions below, operation mode is selected.

- ① If the room temperature thermistor RT11 reads more than set temperature, COOL mode is selected.
- ② If the room temperature thermistor RT11 reads set temperature or less, HEAT mode is selected.

(2) Mode change

In case of the following conditions the operation mode is changed.

- ① COOL mode changes to HEAT mode when 15 minutes have passed with the room temperature 4 °F (2 degrees C) below the set temperature.
- ② HEAT mode changes to COOL mode when 15 minutes have passed with the room temperature 4 °F (2 degrees C) below the set temperature.

In the other cases than the above conditions, the present operation mode is continued.

NOTE 1: Mode selection is performed when multi standby (refer to **NOTE 2**) is released and the unit starts operation with ON-timer.

NOTE 2: If 2 or more indoor units are operating in multi system, there might be a case that the indoor unit, which is operating in AUTO (□), cannot change over the other operating mode (COOL ↔ HEAT) and becomes a state of standby.

NOTE 3: At the beginning of AUTO mode, the air flow direction and the fan speed are set to AUTO and the air outlet selection is set to 2 FLOW.

8-6. AUTO VANE OPERATION

1. Horizontal vane (Horizontal vane/Multi-flow vane)

(1) Vane motor drive

These models are equipped with a stepping motors for the horizontal vanes. The rotating direction, speed, and angle of the motor are controlled by pulse signals (approximately 12 VDC) transmitted from indoor microprocessor.

(2) The horizontal vane angle and mode change as follows by pressing VANE CONTROL () button.

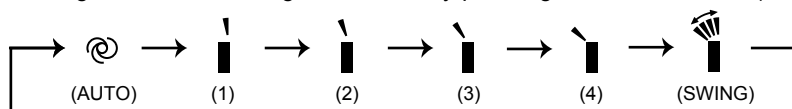

(3) Positioning

The vane presses the vane stopper once to confirm the standard position and then moves to the set angle. Confirming of standard position is performed in case of follows.

- (a) The power supply turns on.
- (b) The operation starts or finishes (including timer operation).
- (c) The test run starts.
- (d) The multi-standby starts or finishes.
- (e) Every time the vane has swung more than the specified numbers of times.
- (f) The horizontal vane automatically moves in certain intervals to determine its position, and then it returns to set position.
- (g) The vane operates for the dew prevention.

(4) Air outlet selection

The air outlet(s) can be selected by pressing to VANE CONTROL () button.

When 2 FLOW is selected, air blows from the top and the front of the unit. When 1 FLOW is selected, air blows only from the top of the unit.

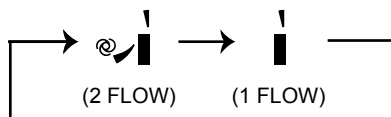

The multi-flow vane is automatically set to the appropriate position.

In HEAT, the multi-flow vane automatically changes its position according to the indoor fan speed.

Even if 2 FLOW is selected, air will blow only from the top of the unit in the following conditions:

- During COOL/DRY: The room temperature is close to set temperature.
The air conditioner has operated for 0.5 to 1 hour.
- During HEAT: The air flow temperature is low. (During defrosting operation, start of operation, etc.)

NOTE:

Movement at the start of the 2 FLOW operation

- COOL/DRY, HEAT: It takes 0.5 to 1 minute to start the 2 FLOW operation.
- HEAT: When cold air blows out from the air outlet, the multi-flow vane may stop moving for up to 10 minutes to make and blow out warm air.

(5) VANE AUTO (@) mode

In VANE AUTO mode, the microprocessor automatically determines the horizontal vane angle to make the optimum room temperature distribution.

In COOL, DRY and FAN operation
2 FLOW: Vane angle is fixed to position 2.

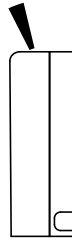

1 FLOW: Vane angle is fixed to position 1.



In HEAT operation
2 FLOW: Vane angle is fixed to position 2.

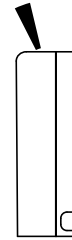

1 FLOW: Vane angle is fixed to position 3.



(6) STOP (operation OFF) and ON TIMER standby

In the following cases, the horizontal vane returns to the closed position.

- (a) When STOP/OPERATE (OFF/ON) button is pressed (POWER OFF).
- (b) When the operation is stopped by the emergency operation.
- (c) When ON TIMER is ON standby.

(7) Dew prevention

During COOL or DRY operation with the vane angle at Angle 3 or 4 when the compressor cumulative operation time exceeds 1 hour, the vane angle automatically changes to Angle 1 for dew prevention.

(8) SWING (🌀) mode

By selecting SWING mode with VANE CONTROL button, the horizontal vanes swing vertically.

The remote controller displays "🌀". SWING mode is cancelled when VANE CONTROL button is pressed once again.

(9) Cold air prevention in HEAT operation

The horizontal vane position is set to Upward.

(10) ECONO COOL (🌡️) operation (ECONOmical operation)

When ECONO COOL button is pressed in COOL mode, set temperature is automatically set 4 °F (2°C) higher by the microprocessor. However, the temperature on the LCD screen on the remote controller is not changed. Also the horizontal vane swings in various cycle.

SWING operation makes you feel cooler than set temperature. So, even though the set temperature is higher, the air conditioner can keep comfort. As a result, energy can be saved.

To cancel this operation, select a different mode or press one of the following buttons in ECONO COOL operation: ECONO COOL, VANE CONTROL, POWERFUL button.

(11) POWERFUL (👉) operation

The air conditioner automatically adjusts the fan speed and the set temperature, and operates the POWERFUL mode.

The POWERFUL mode is cancelled automatically 15 minutes after operation starts, or when POWERFUL button is pressed once again within 15 minutes after operation starts. The operation mode returns to the mode prior to POWERFUL operation. To cancel this operation manually, select a different mode or press one of the following buttons within 15 minutes after operation starts: STOP/OPERATE (OFF/ON), ECONO COOL, FAN SPEED CONTROL, SLEEP or SMART SET button.

8-7. TIMER OPERATION

1. How to set the time

(1) Check that the current time is set correctly.

NOTE: Timer operation will not work without setting the current time. Initially "0:00" blinks at the current time display of TIME MONITOR, so set the current time correctly with CLOCK button.

How to set the current time

(a) Press the CLOCK button.

(b) Press the TIME SET buttons (⏮) and (⏭) to set the current time.

- Each time FORWARD button (⏮) is pressed, the set time increases by 1 minute, and each time BACKWARD button (⏭) is pressed, the set time decreases by 1 minute.
- Pressing those buttons longer, the set time increases/decreases by 10 minutes.

(c) Press the CLOCK set button.

(2) Press STOP/OPERATE (OFF/ON) button to start the air conditioner.

(3) Set the time of timer.

ON timer setting

(a) Press ON TIMER button (⌚ON) during operation.

(b) Set the time of the timer using TIME SET buttons (⏮) and (⏭).*

OFF timer setting

(a) Press OFF TIMER button (⌚OFF) during operation.

(b) Set the time of the timer using TIME SET buttons (⏮) and (⏭).*

* Each time FORWARD button (⏮) is pressed, the set time increases by 10 minutes: each time BACKWARD button (⏭) is pressed, the set time decreases by 10 minutes.

2. To release the timer

To release ON timer, press ON TIMER button (⌚ON).

To release OFF timer, press OFF TIMER button (⌚OFF).

TIMER is cancelled and the display of set time disappears.

PROGRAM TIMER

- OFF timer and ON timer can be used in combination. The set time that is reached first will operate first.
- "←" and "→" display shows the order of OFF timer and ON timer operation.

(Example 1) The current time is 8:00 PM.

The unit turns off at 11:00 PM, and on at 6:00 AM.

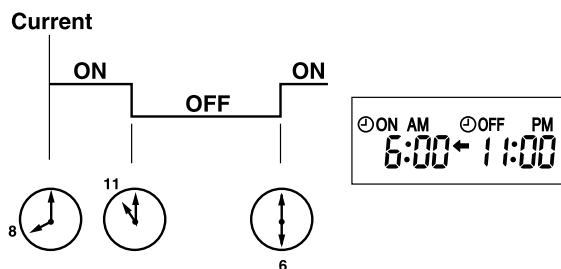

(Example 2) The current time is 11:00 AM.

The unit turns on at 5:00 PM, and off at 9:00 PM.

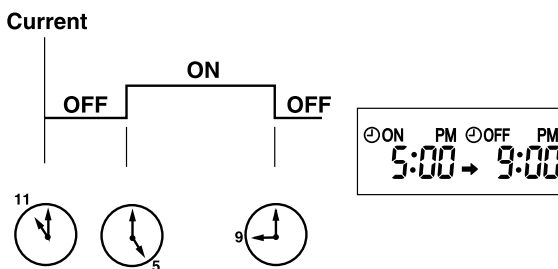

NOTE: If the main power is turned OFF or a power failure occurs while ON/OFF timer is active, the timer setting is cancelled. As these models are equipped with an auto restart function, the air conditioner starts operating with timer cancelled when power is restored.

8-8. WEEKLY TIMER OPERATION

- A maximum of 4 ON or OFF timers can be set for individual days of the week.
- A maximum of 28 ON or OFF timers can be set for a week.

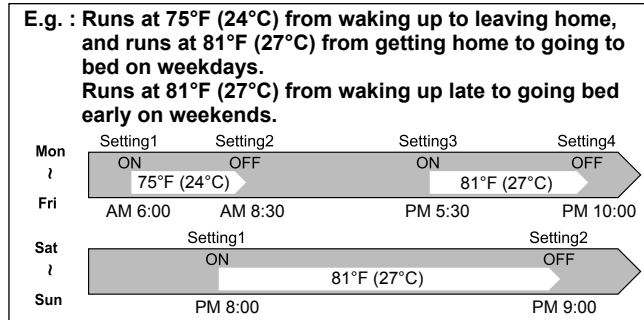

NOTE:

- The simple ON/OFF timer setting is available while the weekly timer is on. In this case, the ON/OFF timer has priority over the weekly timer, the weekly timer operation will start again after the simple ON/OFF timer is complete.
- When the weekly timer is set, temperature cannot be set to 50°F (10°C).
- The weekly timer operation and SMART SET operation cannot be used together.

1. How to set the weekly timer

* Make sure that the current time and day are set correctly.

- (1) Press **EDIT/SEND** **SET** button to enter the weekly timer setting mode.

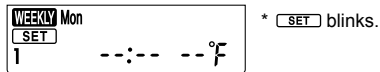

- (2) Press **DAY** and **1~4** buttons to select setting day and number.

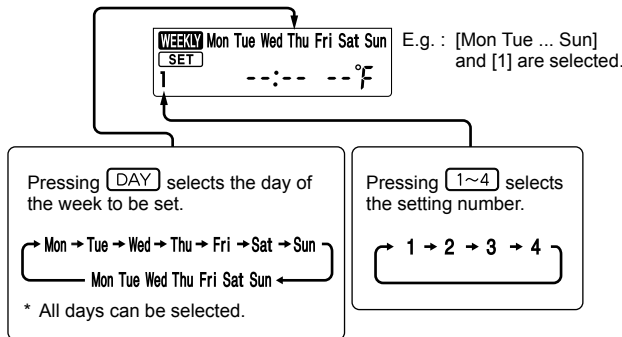

- (3) Press **ON/OFF**, **TIME**, and **TEMP** buttons to set ON/OFF, time, and temperature.

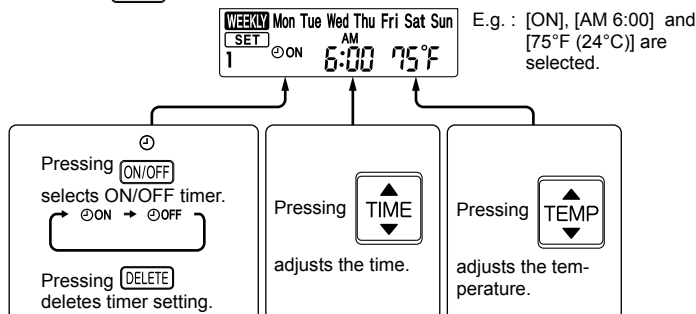



* Hold down the button to change the time quickly.

* The temperature can be set between 61°F and 88°F (16°C and 31°C) at weekly timer.



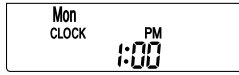

Press **DAY** and **1~4** buttons to continue setting the timer for other days and/or numbers.



(4) Press  button to complete and transmit the weekly timer setting.





*  which was blinking goes out, and the current time will be displayed.

NOTE:

- Press  button to transmit the setting information of weekly timer to the indoor unit. Point the remote controller toward the indoor unit for 3 seconds.
- When setting the timer for more than one day of the week or one number,  button does not have to be pressed per each setting. Press  button once after all the settings are complete. All the weekly timer settings will be saved.
- Press  button to enter the weekly timer setting mode, and press and hold  button for 5 seconds to erase all weekly timer settings. Point the remote controller toward the indoor unit.

(5) Press  button to turn the weekly timer ON. ( lights.)

•When the weekly timer is ON, the day of the week whose timer setting is complete, will light.

Press  button again to turn the weekly timer OFF. ( goes out.)



NOTE:

The saved settings will not be cleared when the weekly timer is turned OFF.

2. Checking weekly timer setting

(1) Press  button to enter the weekly timer setting mode.

* blinks.

(2) Press  or  buttons to view the setting of the particular day or number.

(3) Press  button to exit the weekly timer setting.

NOTE:

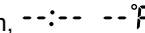
When all days of the week are selected to view the settings and a different setting is included among them,  will be displayed.



8-9. SLEEP (S) OPERATION

1. How to set SLEEP operation

(1) Press STOP/OPERATE (OFF/ON) button.

(2) Select COOL, DRY, HEAT or FAN mode.

(3) Press SLEEP () button.

(4) PRESS TEMPERATURE buttons [ (Increase) and  (Decrease)] to set the temperature of SLEEP operation.

Fan speed: AUTO

Horizontal vane: Position set on the remote controller

Operation indicator lamp: Dimly lit

• Once the above procedure is completed, the settings will be saved.

• After the settings are saved, a single push of SLEEP () button during operation activates SLEEP operation with the same settings every time.

• Temperature for SLEEP operation cannot be set during DRY or FAN mode.

Set temperature for SLEEP operation.

For about 30 minutes after SLEEP () button is pressed, the set temperature remains as set for the operation running when the SLEEP button is pressed. It will change to the set temperature for SLEEP operation in about 30 minutes.

Pressing SLEEP () button again returns the operation to the previous settings.

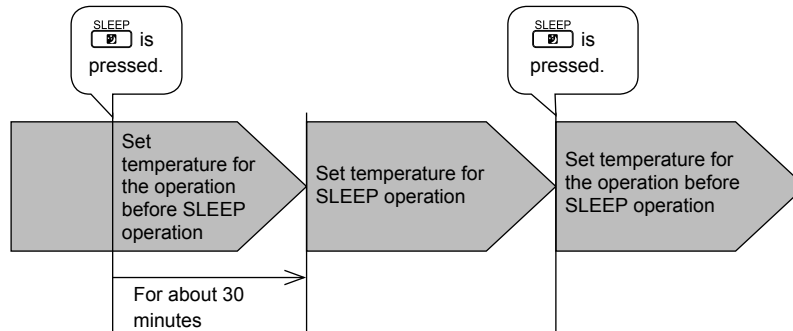

NOTE:

- ON/OFF timer is available during SLEEP operation.
- When a preset ON time for the weekly timer arrives during SLEEP operation, the weekly timer operation has priority. SLEEP operation will be cancelled, and the operation set on the weekly timer will start.

2. How to cancel operation

- Press SLEEP () button again.
- The operation returns to the previous settings.
- SLEEP operation is also cancelled when the FAN button is pressed or the operation mode is changed.

NOTE: SLEEP operation and SMART SET operation cannot be set at same time.

8-10. SMART SET () OPERATION

1. How to set SMART SET operation

- (1) Press STOP/OPERATE (OFF/ON) button.
- (2) Select COOL, HEAT or ECONO COOL mode.
- (3) Press SMART SET button.
- (4) Set the temperature, fan speed, and airflow direction for SMART SET operation.

NOTE:

- SMART SET operation cannot be selected during DRY or AUTO mode operation.
- The setting range of HEAT mode SMART SET operation is 50°F (10°C) and 61 - 88°F (16 - 31°C).
- 2 groups of setting can be saved. (One for COOL/ECONO COOL, one for HEAT)
- SMART SET operation and the weekly timer operation cannot be used together.
- SMART SET operation and SLEEP operation cannot be set at the same time.

2. How to cancel operation

- Press SMART SET button again.
- SMART SET operation can also be cancelled by pressing OPERATION SELECT button to change the operation mode. The same setting is selected from the next time by simply pressing SMART SET button.

8-11. EMERGENCY/TEST OPERATION

In the case of test run operation or emergency operation, use EMERGENCY OPERATION switch on the right side of the indoor unit. Emergency operation is available when the remote controller is missing or has failed, or when the batteries in the remote controller are running down. The unit will start and OPERATION INDICATOR lamp will light up.

The first 30 minutes of operation is the test run operation. This operation is for servicing. The indoor fan runs at High speed and the temperature control does not work. In COOL/HEAT MODE, the air outlet selection is set to 2 FLOW during the test run operation. However, 2 FLOW operation in HEAT MODE is the same operation as the case that 2 FLOW operation is selection by the remote controller.

After 30 minutes of test run operation, the system shifts to EMERGENCY COOL/HEAT MODE with a set temperature of 75°F (24°C). The fan speed shifts to Medium.

In EMERGENCY COOL/HEAT MODE, the air outlet selection is set to 2 FLOW. 2 FLOW operation is the same operation as the case that 2 FLOW operation is selection by the remote controller.

The coil frost prevention works even in the test run or the emergency operation.

In the test run or emergency operation, the horizontal vane operates in VANE AUTO (@) mode.

Emergency operation continues until EMERGENCY OPERATION switch is pressed once or twice or the unit receives any signal from the remote controller. In the latter case, normal operation will start.

NOTE: Do not press EMERGENCY OPERATION switch during normal operation.

Operation mode	COOL/HEAT
Set temperature	75°F (24°C)
Fan speed	Medium
Horizontal vane	Auto
Air outlet	2 FLOW

The operation mode is indicated by the Operation Indicator lamp as following

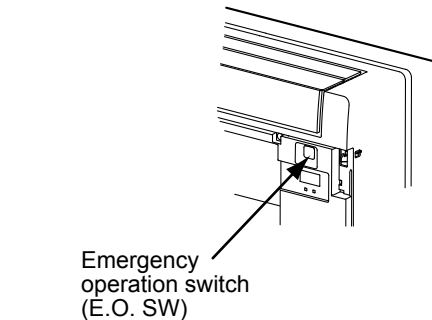
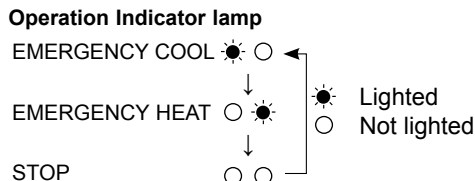

8-12. 3-MINUTE TIME DELAY OPERATION

When the system turns OFF, compressor will not restart for 3 minutes as 3-minute time delay function operates to protect compressor from overload.

8-13. Changing temperature indication (°F/°C)

- The preset unit is °F.
- °F → °C: Press RESET button while the TEMPERATURE buttons are pressed.
- °C → °F: Press RESET button while the TEMPERATURE buttons are pressed.

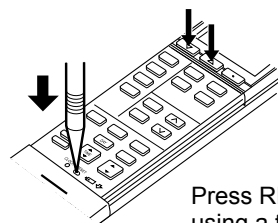

Press RESET button gently using a thin instrument.

MFZ-KJ09NA MFZ-KJ12NA MFZ-KJ15NA MFZ-KJ18NA

9-1. CAUTIONS ON TROUBLESHOOTING

1. Before troubleshooting, check the following

- 1) Check the power supply voltage.
- 2) Check the indoor/outdoor connecting wire for miswiring.

2. Take care of the following during servicing

- 1) Before servicing the air conditioner, be sure to turn OFF the main unit first with the remote controller, and then after confirming the horizontal vane is closed, turn OFF the breaker.
- 2) Be sure to turn OFF the power supply before removing the front panel, the cabinet, the top panel, and the P.C. board.
- 3) When removing the P.C. board, hold the edge of the board with care NOT to apply stress on the components.
- 4) When connecting or disconnecting the connectors, hold the connector housing. DO NOT pull the lead wires.

<Incorrect>

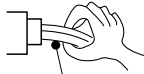

Lead wiring

<Correct>



Connector housing

3. Troubleshooting procedure

- 1) Check if the OPERATION INDICATOR lamp on the indoor unit is flashing ON and OFF to indicate an abnormality. To make sure, check how many times the OPERATION INDICATOR lamp is flashing ON and OFF before starting service work.
- 2) Before servicing, check that the connector and terminal are connected properly.
- 3) When the electronic control P.C. board seems to be defective, check the copper foil pattern for disconnection and the components for bursting and discoloration.
- 4) When troubleshooting, Refer to 9-2, 9-3 and 9-4.

4. How to replace batteries

Weak batteries may cause the remote controller malfunction.

In this case, replace the batteries to operate the remote controller normally.

- ① Remove the front lid and insert batteries. Then reattach the front lid.

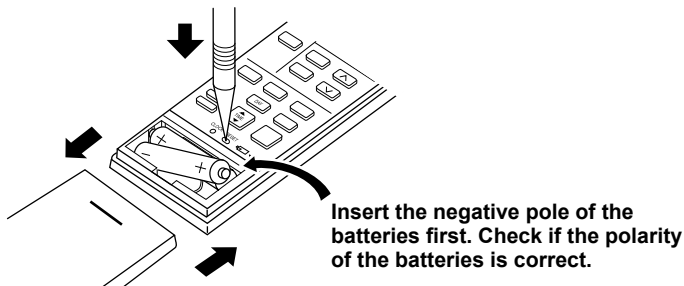

- ② Press RESET button with a thin instrument, and then use the remote controller.

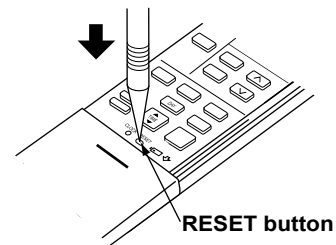

- NOTE:**
1. If RESET button is not pressed, the remote controller may not operate correctly.
 2. This remote controller has a circuit to automatically reset the microcomputer when batteries are replaced. This function is equipped to prevent the microcomputer from malfunctioning due to the voltage drop caused by the battery replacement.
 3. Do not use the leaking batteries.

5. Description of multi system air conditioner

OUTDOOR UNIT: MXZ series

The multi system outdoor unit can be connected to 2 or more indoor units.

- The units do not operate and the operation indicator lamp flashes as shown in the figure below when the total capacity of the indoor units exceed the capacity of the outdoor unit. Do not connect the indoor units beyond the outdoor unit capacity.
- When operating the 2 or more indoor units connected to a multi system outdoor unit, set all the indoor units to the same operation mode. If the COOL and the HEAT modes are selected for those indoor units, the indoor unit which has started operation first has a priority. The other indoor units set to the different operation mode later do not start operation and the operation indicator lamp flashes as shown in the figure below.

OPERATION INDICATOR



Lighted (Green)



Blinking (Green)



Not lighted

- When the indoor units start operation while the defrosting of the outdoor unit is being performed, it takes a few minutes (up to 10 minutes) to blow out warm air.
- In the heating operation, even though the indoor unit is not running, the room may get warm or the sound of refrigerant flowing may be heard. This is not a malfunction. They happen because the refrigerant is continuously flowing inside the unit.

9-2. FAILURE MODE RECALL FUNCTION

Outline of the function

This air conditioner can memorize the abnormal condition which has occurred once.

Even though OPERATION INDICATOR lamp indication listed on the troubleshooting check table (9-4.) disappears, the memorized failure details can be recalled.

This mode is very useful when the unit needs to be repaired for the abnormality which does not recur.

1. Flow chart of failure mode recall function for the indoor/outdoor unit

Operational procedure

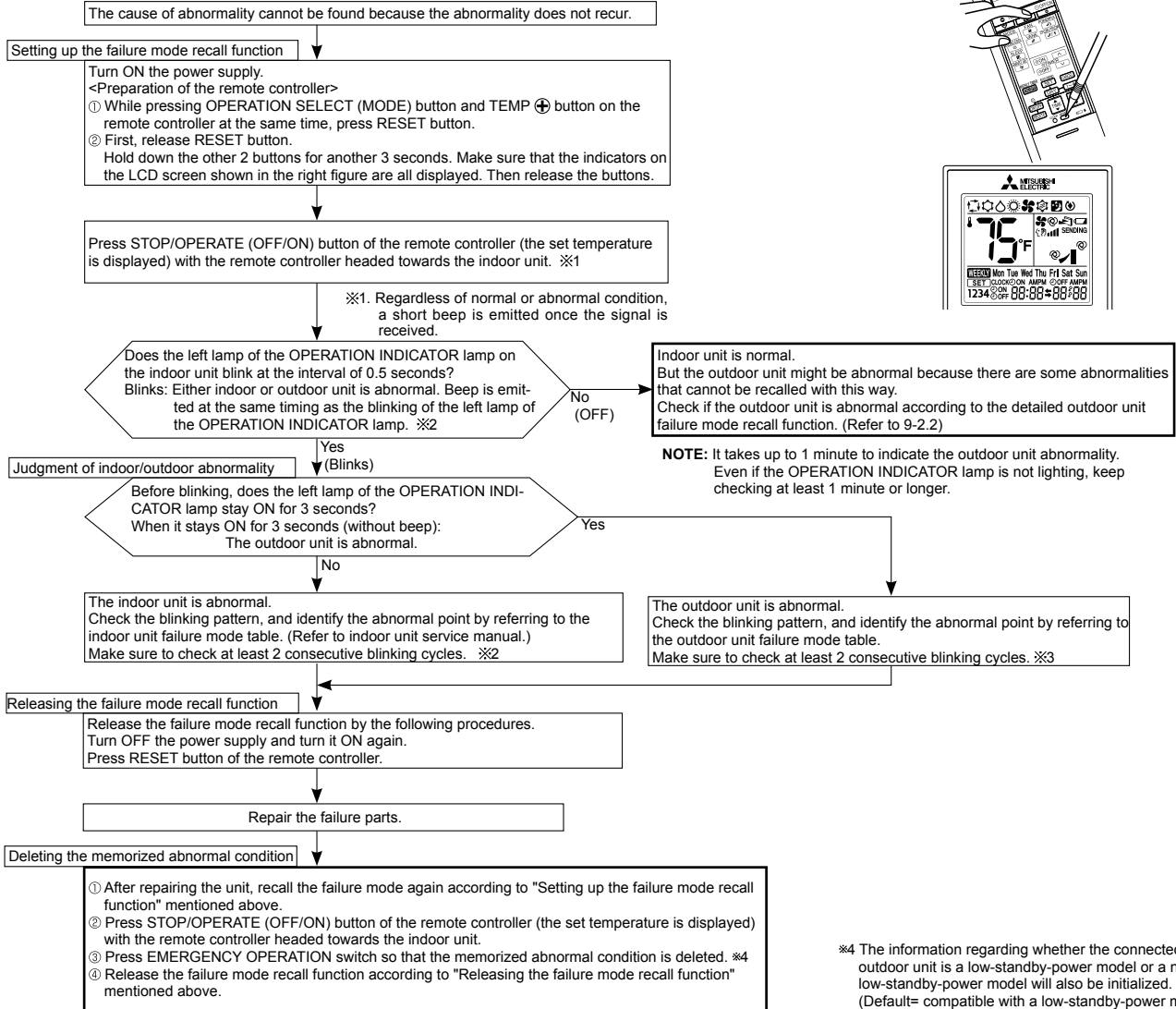

NOTE: 1. Make sure to release the failure mode recall function after it is set up, otherwise the unit cannot operate properly.
 2. If the abnormal condition is not deleted from the memory, the last abnormal condition is kept memorized.

※2. Blinking pattern when the indoor unit is abnormal:

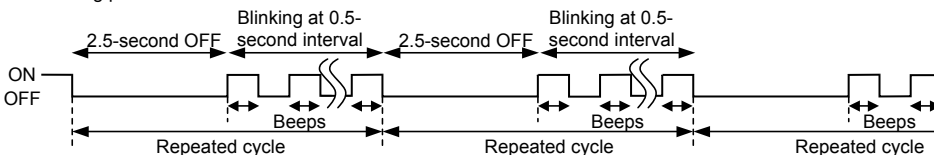

※3. Blinking pattern when the outdoor unit is abnormal:

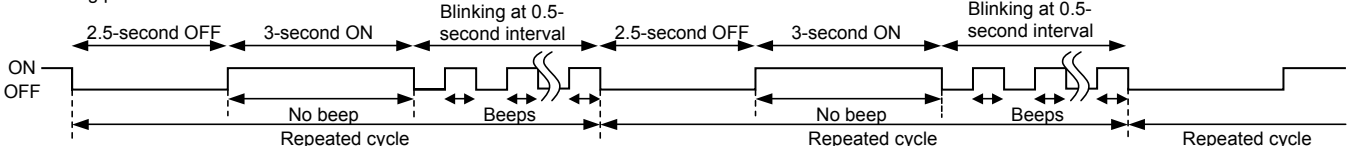

2. Indoor unit failure mode table

NOTE: Blinking patterns of this mode differs from the ones of Troubleshooting check table (9-4.).

Left lamp of OPERATION INDICATOR lamp	Right lamp of OPERATION INDICATOR lamp	Abnormal point (Failure mode)	Condition	Remedy
Not lighted	Not lighted	Normal	–	–
1-time flash every 0.5-second	Not lighted	Room temperature thermistor	The room temperature thermistor short or open circuit is detected every 8 seconds during operation.	Refer to the characteristics of the room temperature thermistor (9-7.).
2-time flash 2.5-second OFF	Not lighted	Indoor coil thermistor (Main 1, 2 and sub)	The indoor coil thermistor short or open circuit is detected every 8 seconds during operation.	Refer to the characteristic of the main indoor coil thermistors 1 and 2 and the sub indoor coil thermistor (9-7.).
3-time flash 2.5-second OFF	Not lighted	Serial signal error	The serial signal from the outdoor unit is not received for a maximum of 6 minutes.	Refer to 9-6.⑥ "How to check miswiring and serial signal error".
11-time flash 2.5-second OFF	Not lighted	Indoor fan motor	The rotational frequency feedback signal is not emitted during 12-second the indoor fan operation.	Refer to 9-6 ④ "Check of indoor fan motor.
12-time flash 2.5-second OFF	Not lighted	Indoor control system	It cannot properly read data in the nonvolatile memory of the indoor electronic control P.C. board.	Replace the indoor electronic control P.C. board.
13-time flash 2.5-second OFF	Not lighted	Indoor coil thermistor (Main 3)	The indoor coil thermistor short or open circuit is detected every 8 seconds during operation.	Refer to the characteristic of the main indoor coil thermistor 3 (9-7.).

9-3. INSTRUCTION OF TROUBLESHOOTING

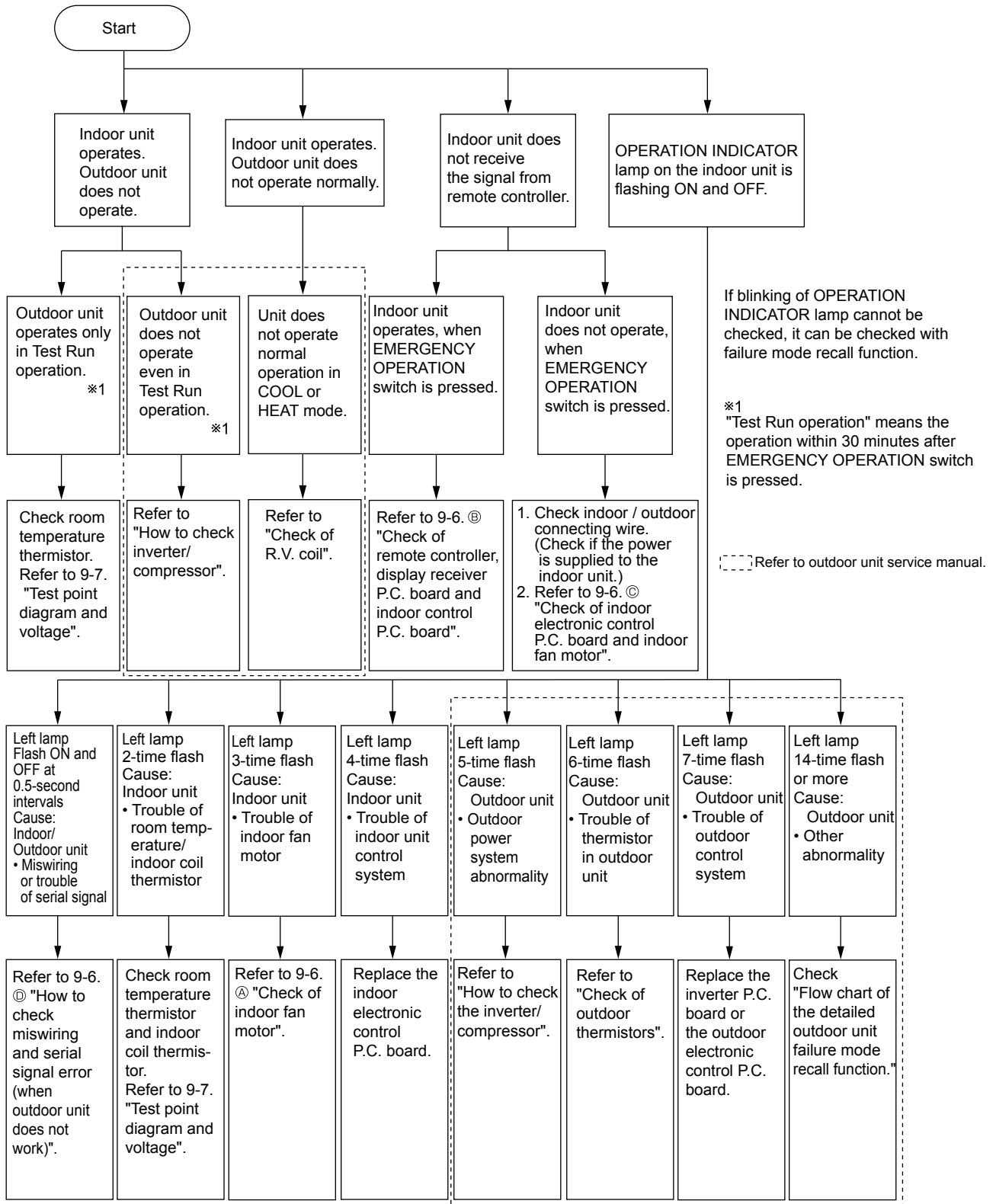

9-4. TROUBLESHOOTING CHECK TABLE

Before taking measures, make sure that the symptom reappears for accurate troubleshooting.
When the indoor unit has started operation and detected an abnormality of the following condition (the first detection after the power ON), the indoor fan motor turns OFF and OPERATION INDICATOR lamp flashes.

OPERATION INDICATOR

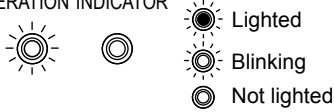

No.	Abnormal point	Operation indicator lamp	Symptom	Condition	Remedy
1	Miswiring or serial signal	Left lamp flashes. 0.5-second ON ●○○○○○○○○ 0.5-second OFF	Indoor unit and outdoor unit do not operate.	The serial signal from the outdoor unit is not received for a maximum of 6 minutes.	• Refer to 9-6.⑥ "How to check miswiring and serial signal error".
2	Indoor coil thermistor Room temperature thermistor	Left lamp flashes. 2-time flash ●○○○○○○○○●○○○○ 2.5-second OFF	Indoor unit and outdoor unit do not operate.	The indoor coil or the room temperature thermistor is short or open circuit.	• Refer to the characteristics of indoor coil thermistor, and the room temperature thermistor on 9-7.
3	Indoor fan motor	Left lamp flashes. 3-time flash ●○○○○○○○○●○○○○●○○○○ 2.5-second OFF	Indoor unit and outdoor unit do not operate.	The rotational frequency feedback signal is not emitted during the indoor fan operation.	• Refer to 9-6.⑦ "Check of indoor fan motor".
4	Indoor control system	Left lamp flashes. 4-time flash ●○○○○○○○○●○○○○●○○○○●○○○○ 2.5-second OFF	Indoor unit and outdoor unit do not operate.	It cannot properly read data in the nonvolatile memory of the indoor electronic control P.C. board.	• Replace the indoor electronic control P.C. board.
5	Outdoor power system	Left lamp flashes. 5-time flash ●○○○○○○○○●○○○○●○○○○●○○○○●○○○○ 2.5-second OFF	Indoor unit and outdoor unit do not operate.	It consecutively occurs 3 times that the compressor stops for overcurrent protection or start-up failure protection within 1 minute after start-up.	• Refer to "Check of inverter/compressor". Refer to the outdoor unit service manual. Check the stop valve.
6	Outdoor thermistors	Left lamp flashes. 6-time flash ●○○○○○○○○●○○○○●○○○○●○○○○●○○○○●○○○○ 2.5-second OFF	Indoor unit and outdoor unit do not operate.	The outdoor thermistors short or open circuit during the compressor operation.	• Refer to "Check of outdoor thermistor". Refer to the outdoor unit service manual.
7	Outdoor control system	Left lamp flashes. 7-time flash ●○○○○○○○○●○○○○●○○○○●○○○○●○○○○●○○○○●○○○○ 2.5-second OFF	Indoor unit and outdoor unit do not operate.	It cannot properly read data in the nonvolatile memory of the inverter P.C. board or the outdoor electronic control P.C. board.	• Replace the inverter P.C. board or the outdoor electronic control P.C. board. Refer to the outdoor unit service manual.
8	Other abnormality	Left lamp flashes. 14-time flash or more ●○○○○○○○○●○○○○●○○○○●○○○○●○○○○●○○○○●○○○○●○○○○●○○○○●○○○○●○○○○●○○○○●○○○○ 2.5-second OFF	Indoor unit and outdoor unit do not operate.	An abnormality other than above mentioned is detected.	• Check the stop valve. • Check the 4-way valve. • Check the abnormality in detail using the failure mode recall function. Refer to the outdoor unit service manual.
9	Outdoor control system	Left lamp lights up ●	Outdoor unit does not operate.	It cannot properly read data in the nonvolatile memory of the inverter P.C. board or the outdoor electronic control P.C. board.	• Check the blinking pattern of the LED on the inverter P.C. board or the outdoor electronic control P.C. board.

OPERATION INDICATOR

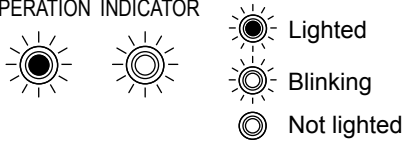

No.	Abnormal point	Operation indicator lamp	Symptom	Condition	Remedy
1	MXZ type Operation mode setting	<p>Right lamp flash</p>	Outdoor unit operates but indoor unit does not operate.	When the operation mode of the each indoor unit is differently set to COOL (includes DRY) and HEAT at the same time, the operation mode of the indoor unit that has operated first has the priority.	<ul style="list-style-type: none"> Select the same operation mode for all the units. Refer to the outdoor unit service manual.

9-5. TROUBLE JUDGEMENT CRITERIA OF MAIN PARTS
MFZ-KJ09NA MFZ-KJ12NA MFZ-KJ15NA MFZ-KJ18NA

Part name	Check method and criteria	Figure				
Room temperature thermistor (RT11)	Measure the resistance with a tester.					
Indoor coil thermistor (RT12 (MAIN 1), RT13 (SUB) RT14 (MAIN 2), RT15 (MAIN 3))	Refer to 9-7. "Test point diagram and voltage", "Indoor electronic control P.C. board", for the chart of thermistor.					
Indoor fan motor (MF)	Check 9-6. Ⓐ "Check of indoor fan motor" and Ⓒ "Check of indoor electronic control P.C. board and indoor fan motor".					
Horizontal vane motor (MV1) FRONT	Measure the resistance between the terminals with a tester. (Part temperature: 50°F - 86°F (10°C - 30°C)) <table border="1" style="margin-left: auto; margin-right: auto;"> <thead> <tr> <th>Color of the lead wire</th> <th>Normal</th> </tr> </thead> <tbody> <tr> <td>BRN-other one (250 Ω)</td> <td>219 Ω - 273 Ω</td> </tr> </tbody> </table>	Color of the lead wire	Normal	BRN-other one (250 Ω)	219 Ω - 273 Ω	
Color of the lead wire	Normal					
BRN-other one (250 Ω)	219 Ω - 273 Ω					
Horizontal vane motor (MV2) BACK	Measure the resistance between the terminals with a tester. (Part temperature: 50°F - 86°F (10°C - 30°C)) <table border="1" style="margin-left: auto; margin-right: auto;"> <thead> <tr> <th>Color of the lead wire</th> <th>Normal</th> </tr> </thead> <tbody> <tr> <td>BRN-other one (250 Ω)</td> <td>219 Ω - 273 Ω</td> </tr> </tbody> </table>	Color of the lead wire	Normal	BRN-other one (250 Ω)	219 Ω - 273 Ω	
Color of the lead wire	Normal					
BRN-other one (250 Ω)	219 Ω - 273 Ω					
Multi-flow vane motor (MV3)	Measure the resistance between the terminals with a tester. (Part temperature: 50°F - 86°F (10°C - 30°C)) <table border="1" style="margin-left: auto; margin-right: auto;"> <thead> <tr> <th>Color of the lead wire</th> <th>Normal</th> </tr> </thead> <tbody> <tr> <td>BRN-other one (350 Ω)</td> <td>306 Ω - 382 Ω</td> </tr> </tbody> </table>	Color of the lead wire	Normal	BRN-other one (350 Ω)	306 Ω - 382 Ω	
Color of the lead wire	Normal					
BRN-other one (350 Ω)	306 Ω - 382 Ω					

9-6. TROUBLESHOOTING FLOW

A Check of indoor fan motor

The indoor fan motor error has occurred, and the indoor fan does not operate.

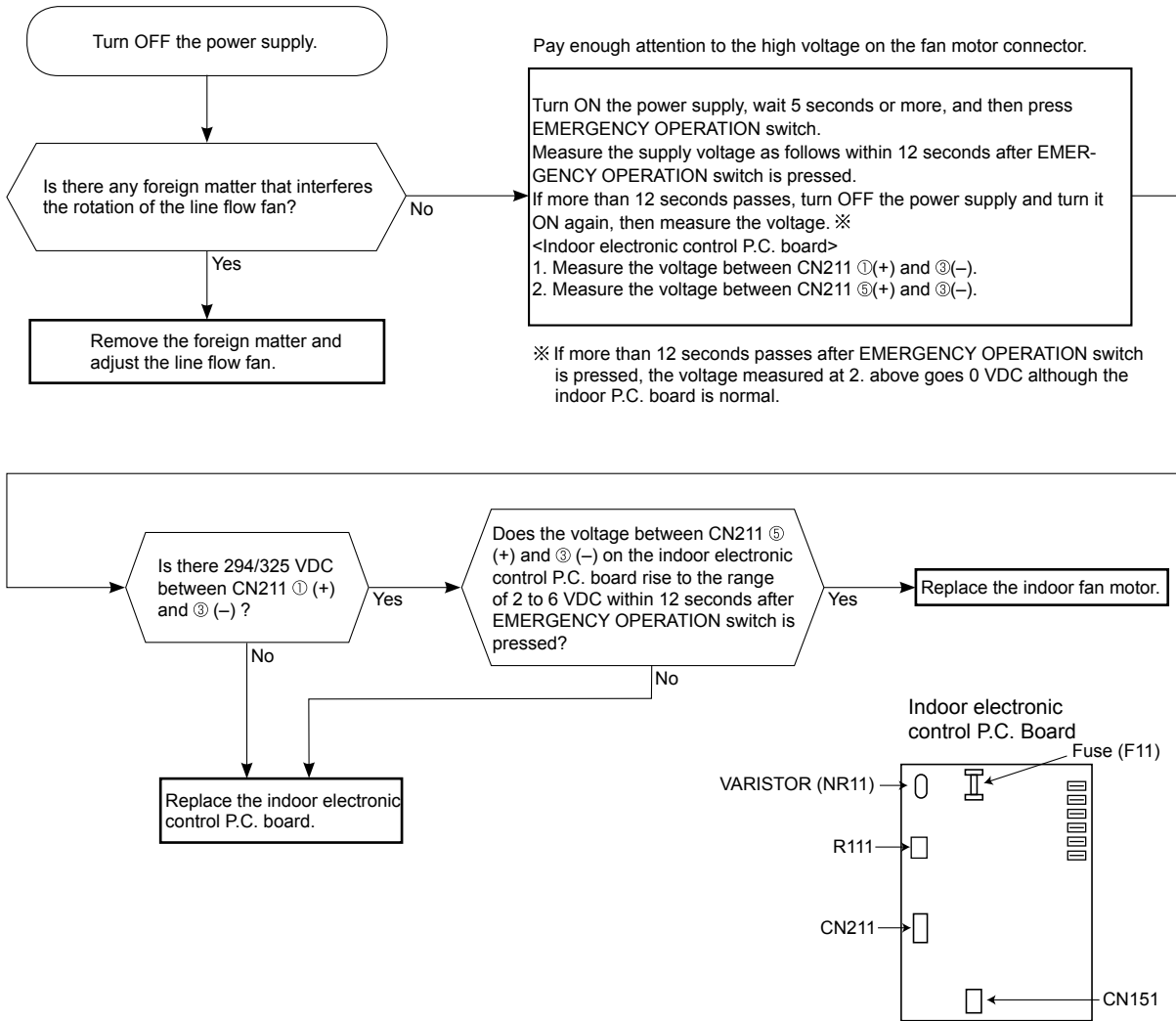

The indoor fan motor error has occurred, and the indoor fan repeats "12-second ON and 30-second OFF" 3 times, and then stops.

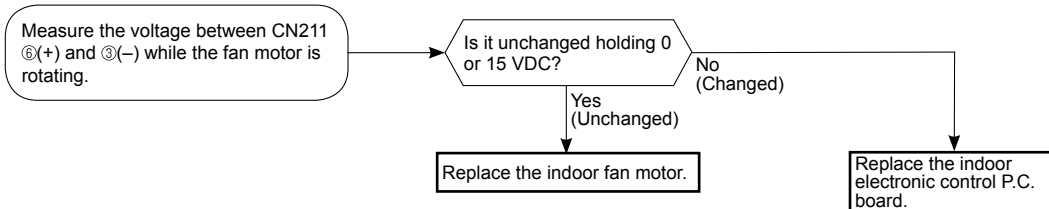

B Check of remote controller, display receiver P.C. board and indoor control P.C. board

※Check if the remote controller is exclusive for this air conditioner.

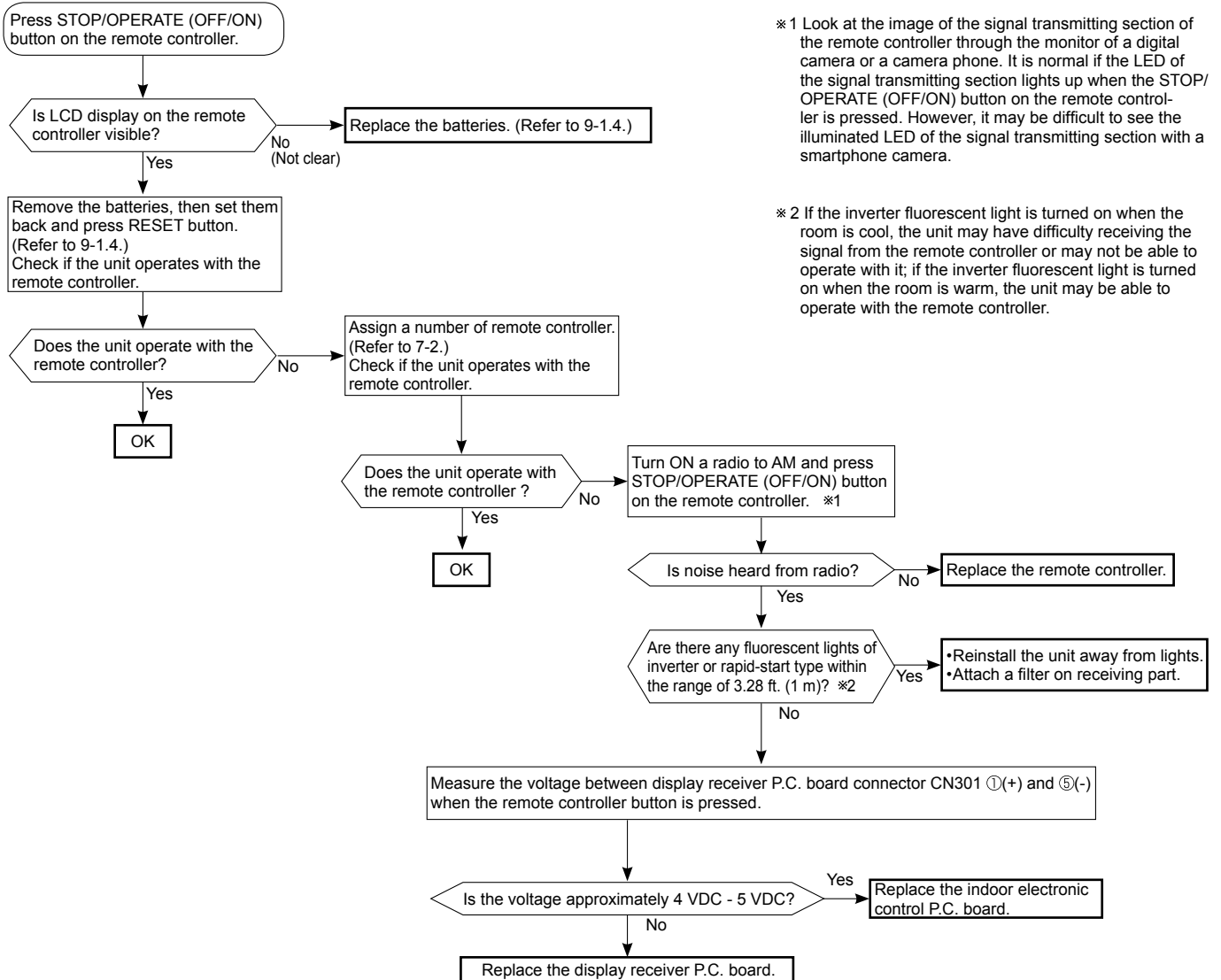

※1 Look at the image of the signal transmitting section of the remote controller through the monitor of a digital camera or a camera phone. It is normal if the LED of the signal transmitting section lights up when the STOP/OPERATE (OFF/ON) button on the remote controller is pressed. However, it may be difficult to see the illuminated LED of the signal transmitting section with a smartphone camera.

※2 If the inverter fluorescent light is turned on when the room is cool, the unit may have difficulty receiving the signal from the remote controller or may not be able to operate with it; if the inverter fluorescent light is turned on when the room is warm, the unit may be able to operate with the remote controller.

© Check of indoor electronic control P.C. board and indoor fan motor

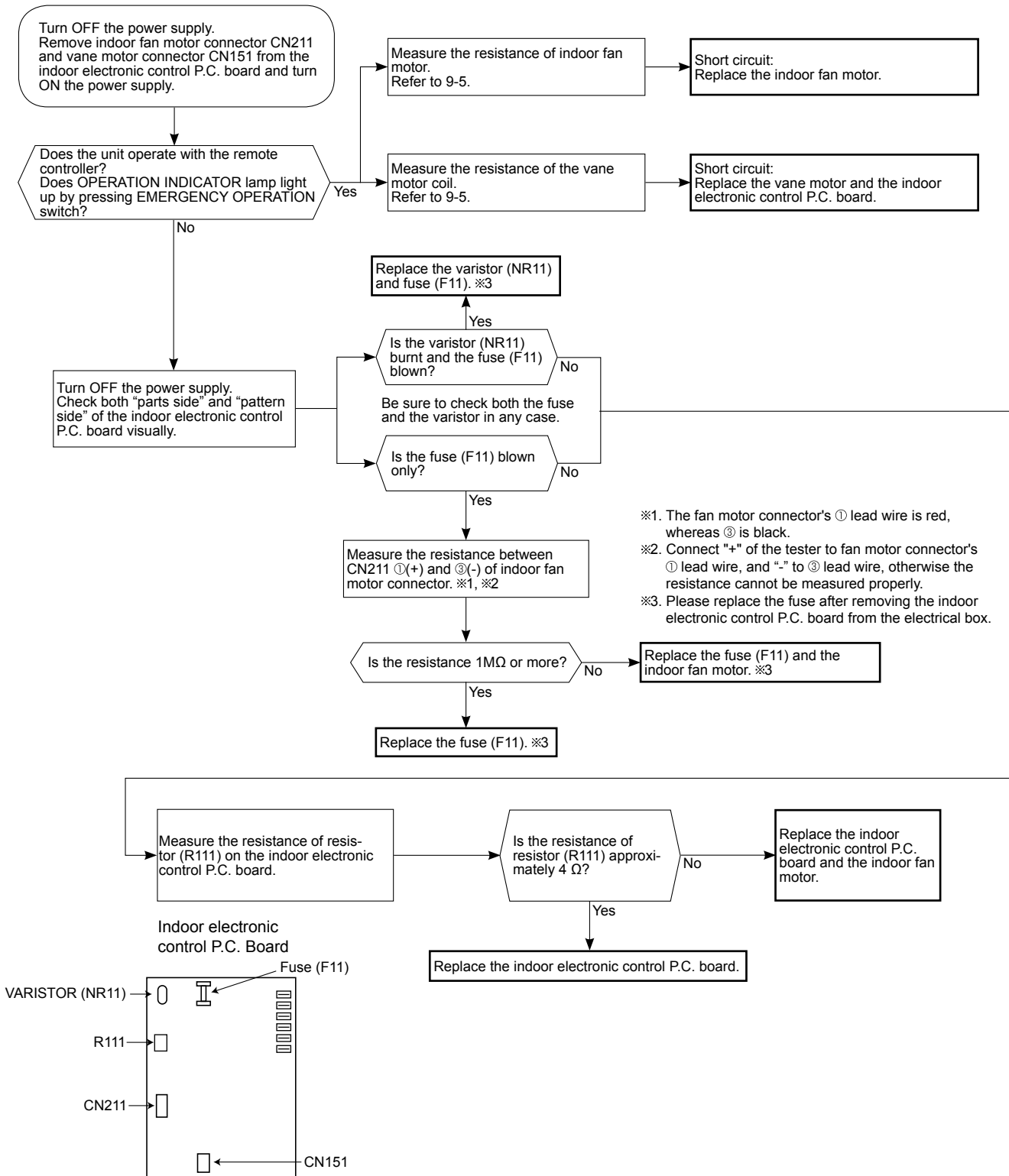

D How to check miswiring and serial signal error

MUFZ Type

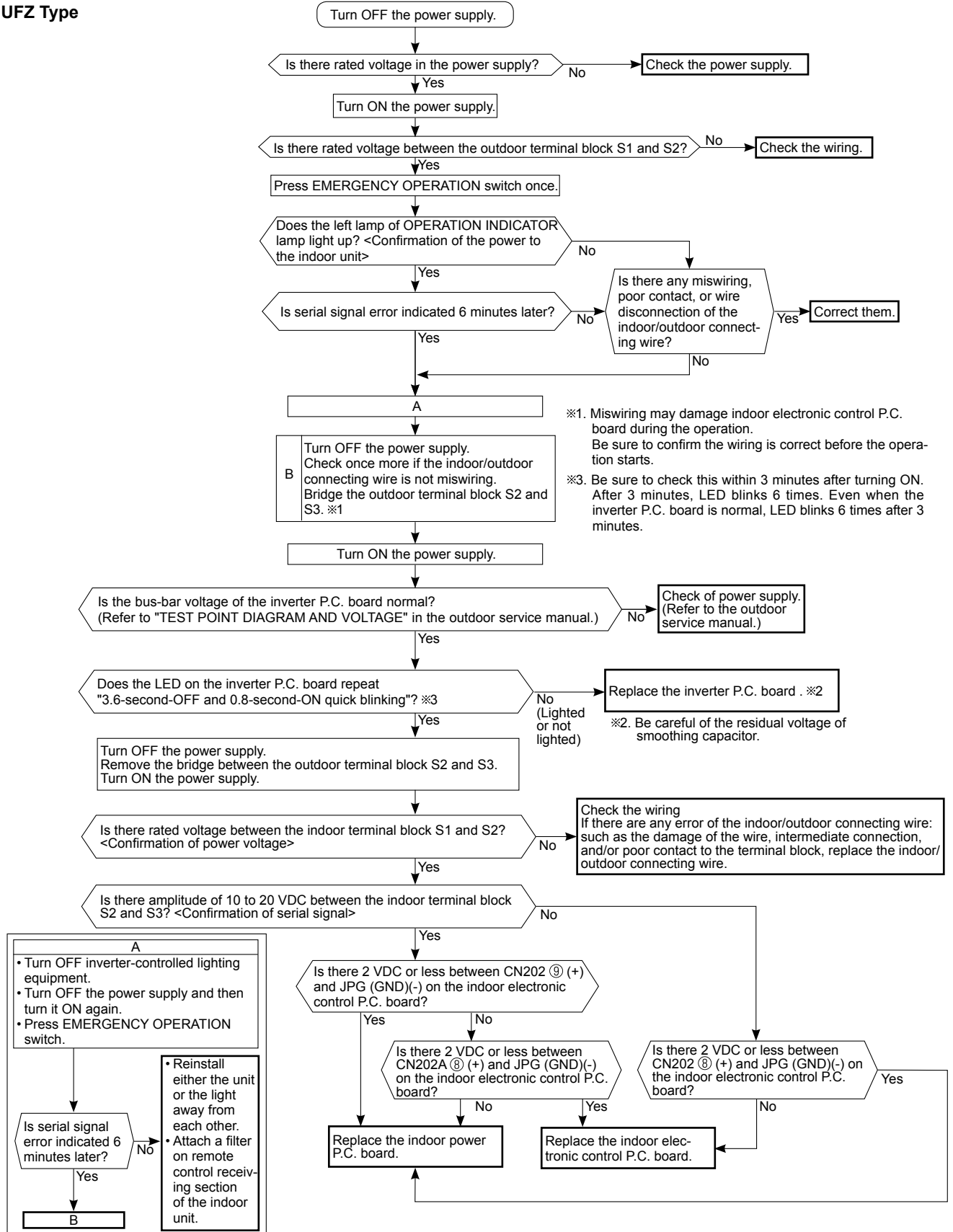

MXZ Type

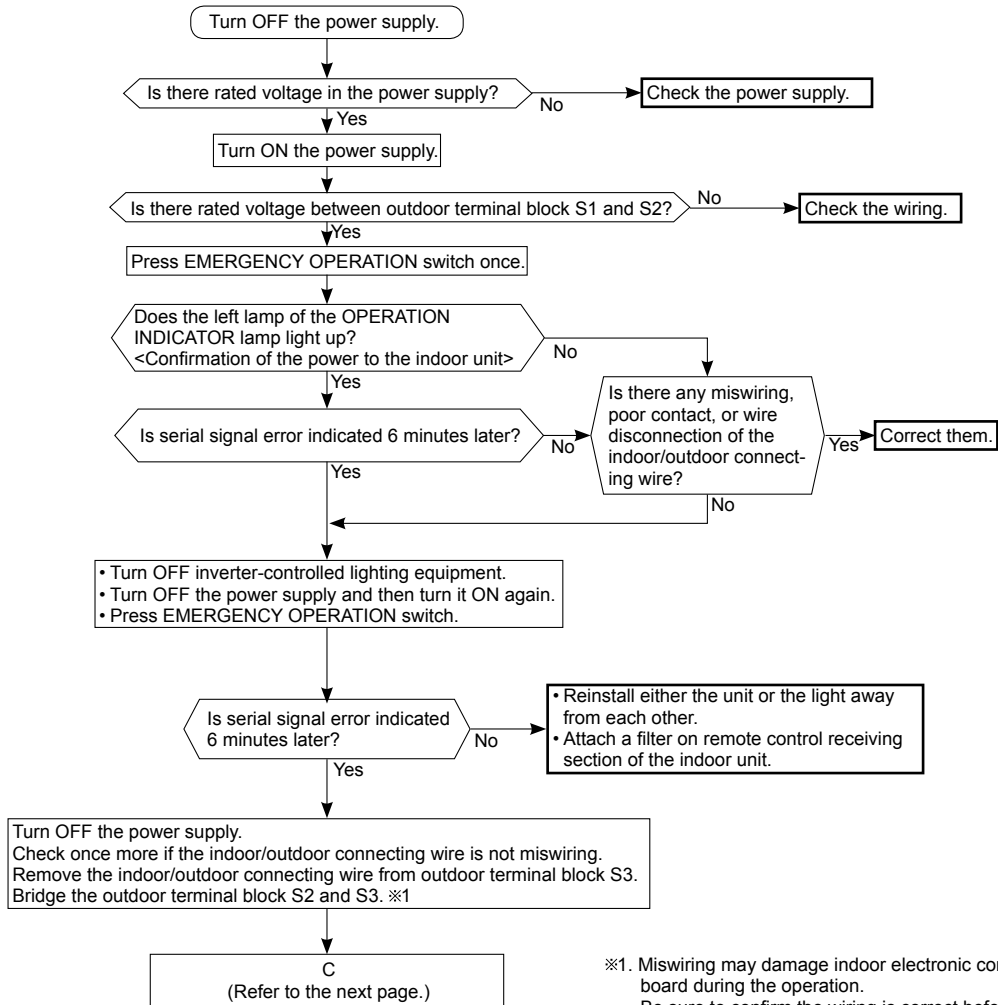

※1. Miswiring may damage indoor electronic control P.C. board during the operation. Be sure to confirm the wiring is correct before the operation starts.

LED indication for communication status

Communication status is indicated by the LED.

Unit status

Blinking: normal communication
Lighting: abnormal communication or not connected

Pattern 1 and 2 is repeatedly displayed alternately. Each pattern is displayed for 15 seconds.

NOTE: "Lighting" in the table below does not indicate abnormal communication.

Outdoor control P.C. board

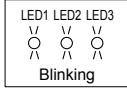

Pattern	LED 1	LED 2	LED 3
1	Unit A status	Unit B status	Lighted
2	Unit C status	Unit D status	Not lighted
3	Unit E status	—	Blinking

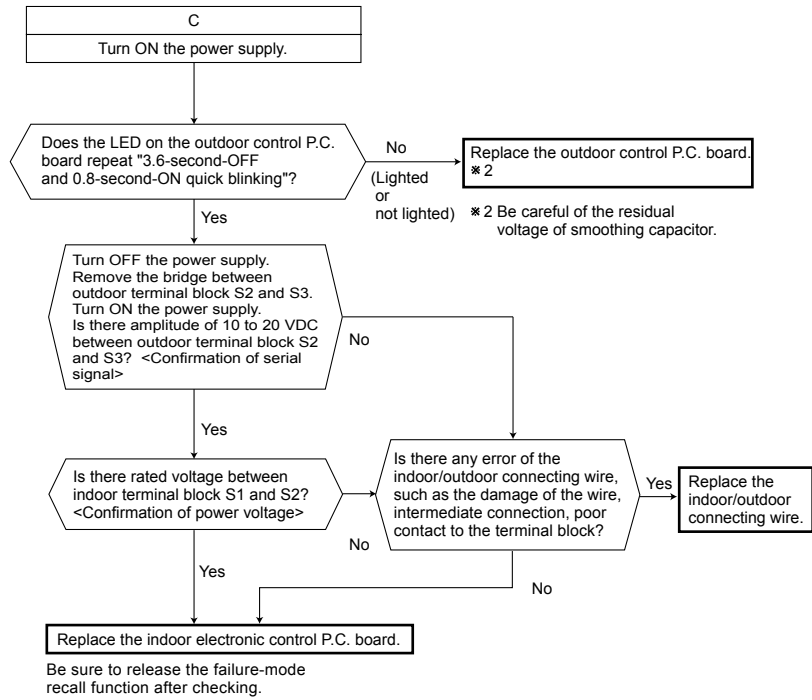

E Electromagnetic noise enters into TV sets or radios

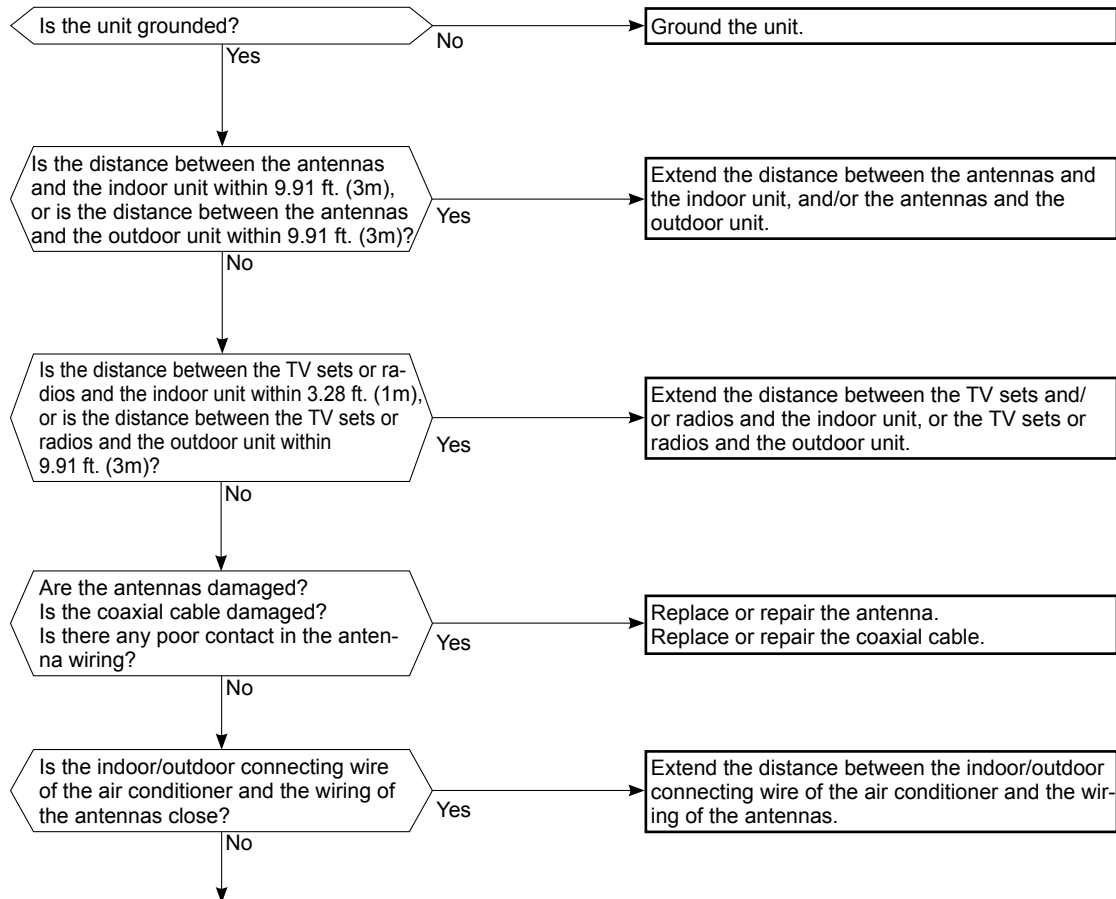

Even if all of the above conditions are fulfilled, the electromagnetic noise may enter, depending on the electric field strength or the installation condition (combination of specific conditions such as antennas or wiring).

Check the following before asking for service.

1. Devices affected by the electromagnetic noise
TV sets, radios (FM/AM broadcast, shortwave)
2. Channel, frequency, broadcast station affected by the electromagnetic noise
3. Channel, frequency, broadcast station unaffected by the electromagnetic noise
4. Layout of:
indoor/outdoor unit of the air conditioner, indoor/outdoor wiring, ground wire, antennas, wiring from antennas, receiver
5. Electric field intensity of the broadcast station affected by the electromagnetic noise
6. Presence or absence of amplifier such as booster
7. Operation condition of air conditioner when the electromagnetic noise enters in
 - 1) Turn OFF the power supply once, and then turn ON the power supply. In this situation, check for the electromagnetic noise.
 - 2) Within 3 minutes after turning ON the power supply, press STOP/OPERATE (OFF/ON) button on the remote controller for power ON, and check for the electromagnetic noise.
 - 3) After a short time (3 minutes later after turning ON), the outdoor unit starts running. During operation, check for the electromagnetic noise.
 - 4) Press STOP/OPERATE (OFF/ON) button on the remote controller for power OFF, when the outdoor unit stops but the indoor/outdoor communication still runs on. In this situation, check for the electromagnetic noise.

9-7. TEST POINT DIAGRAM AND VOLTAGE
MFZ-KJ09NA MFZ-KJ12NA MFZ-KJ15NA MFZ-KJ18NA
Indoor electronic control P.C. board

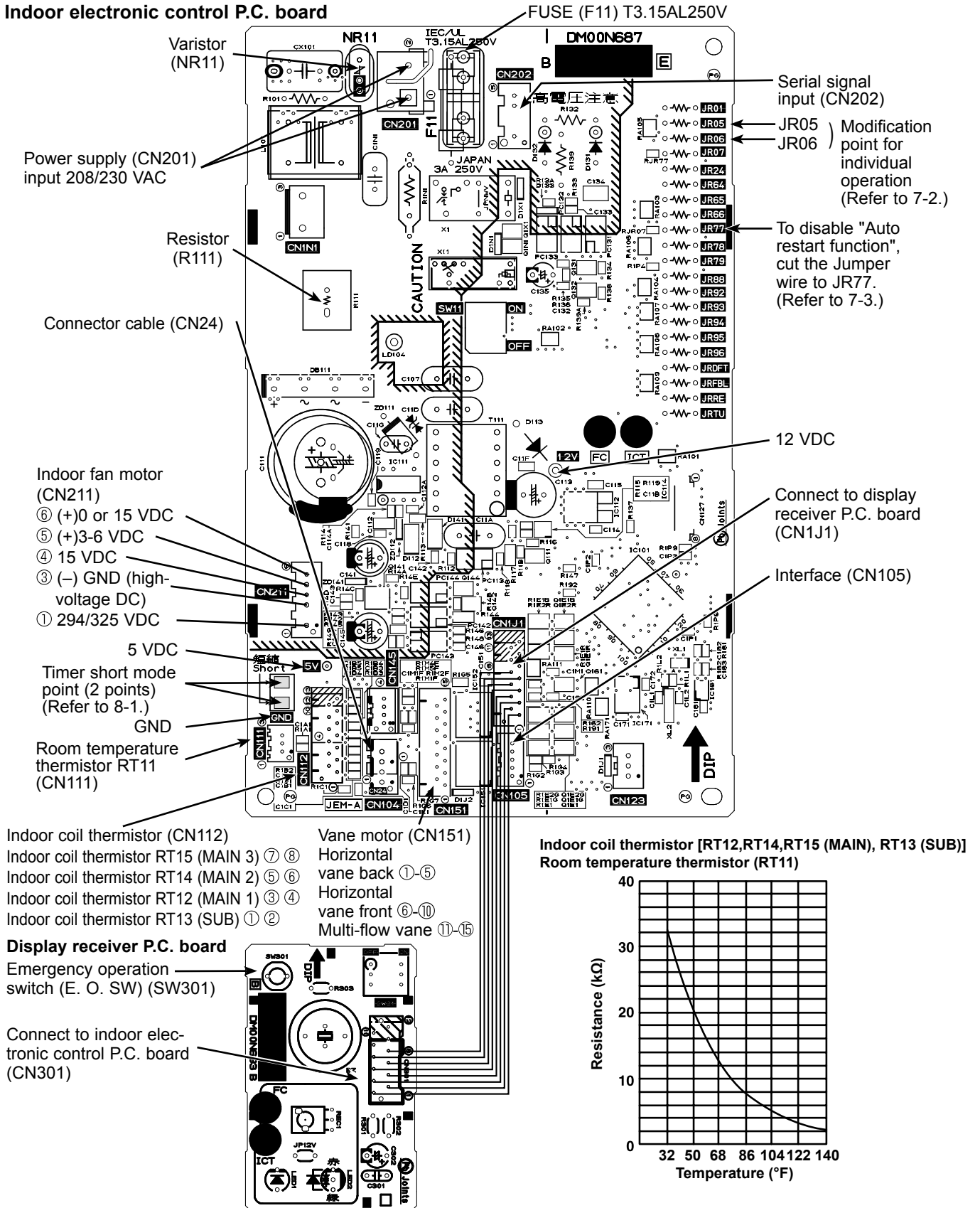

<"Terminal with locking mechanism" Detaching points>

The terminal which has the locking mechanism can be detached as shown below. There are 2 types (refer to (1) and (2)) of the terminal with locking mechanism.

The terminal without locking mechanism can be detached by pulling it out.

Check the shape of the terminal before detaching.

(1) Slide the sleeve and check if there is a locking lever or not.

(2) The terminal with this connector has the locking mechanism.

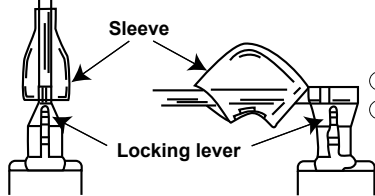

- ① Slide the sleeve.
- ② Pull the terminal while pushing the locking lever.

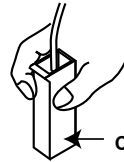

- ① Hold the sleeve, and pull out the terminal slowly.

Connector

10-1. MFZ-KJ09NA MFZ-KJ12NA MFZ-KJ15NA MFZ-KJ18NA

NOTE: Turn OFF the power supply before disassembly.

OPERATING PROCEDURE	PHOTOS
<p>1. Removing the panel</p> <ol style="list-style-type: none"> (1) Push down the tabs on the both sides of the unit. (2) Open the front panel toward you and pull it out upwards. (3) Remove the screws of the panel. (4) Open the horizontal vane (back) and push the ▼ marks on the top of the panel, and pull the panel toward you. (5) Lift up the panel and remove it from the unit. 	<p>Photo 1</p> <p>Tabs of the unit</p> <p>Photo 2</p> <p>Push the ▼ marks.</p> <p>Screw of the panel</p> <p>Screw of the panel</p>
<p>2. Removing the electrical box</p> <ol style="list-style-type: none"> (1) Remove the panel. (Refer to 1.) (2) Remove the screw of the V.A. clamp cover and remove the V.A. clamp cover. (3) Remove the screw of the electrical cover and remove the electrical cover. (4) Remove the screw of the indoor/outdoor connecting wire, and then the indoor/outdoor connecting wire. (5) Remove the screws of the conduit box, and remove the conduit box. (6) Remove the earth wire connected to the indoor heat exchanger. (Photo 4) (7) Remove the screw of the electrical box. (Photo 5) (8) Disconnect the following connectors on the electronic control P.C. board. <ul style="list-style-type: none"> • Fan motor connector < CN211> (Photo 5) • Indoor coil thermistor connector < CN112> (Photo 5) (9) Rotate the display receiver P.C. board holder to the right side and disconnect the vane motor relay connector. (Photo 6) (10) Disengage the electrical box from the upper catch and pull out the electrical box from the box. 	<p>Photo 3</p> <p>Screw of the electrical cover</p> <p>Screw of the V.A. clamp cover</p> <p>Conduit box</p> <p>Screws of the conduit box</p>

OPERATING PROCEDURE

3. Removing the electronic control P.C. board and the display receiver P.C. board

- (1) Remove the panel. (Refer to 1.)
- (2) Remove the electrical box. (Refer to 2.)
- (3) Remove the earth wire connected to the electronic control P.C. board.
- (4) Disconnect all the connectors on the electronic control P.C. board.
- (5) Pull out the electronic control P.C. board from the electrical box.
- (6) Disengage the catches on the lead guide.
- (7) Disengage the display receiver P.C. board holder from the catch on the electrical box.
- (8) Open the display receiver P.C. board holder and pull out the display receiver P.C. board.

※ Attaching the connectors

Run the lead wires with the connectors as they were before the disassembly.

4. Removing the nozzle assembly

- (1) Remove the panel. (Refer to 1.)
- (2) Rotate the display receiver P.C. board holder to the right side and disconnect the vane motor relay connector.
- (3) Remove the fixed screws on the both sides of the nozzle.
- (4) Disengage the catches on the nozzle from the box.
- (5) Hold the both sides of the nozzle. Rotate the nozzle toward you around the right and left ribs to remove it.

Photo 7

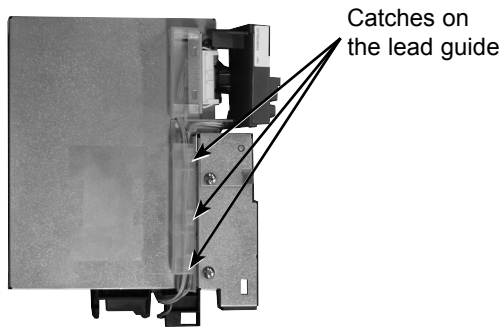
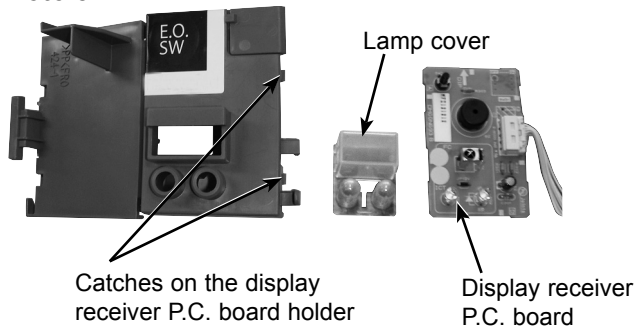

Photo 8



PHOTOS

Photo 4

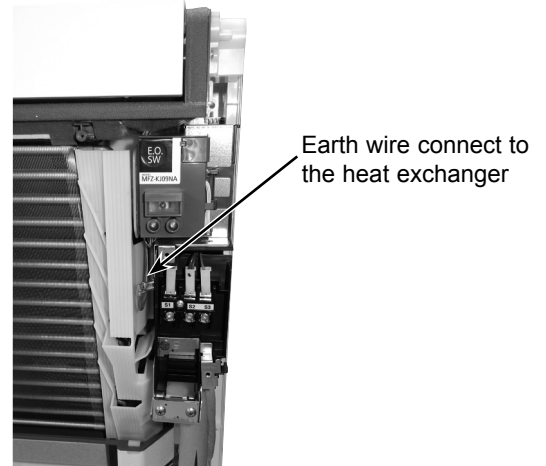

Photo 5

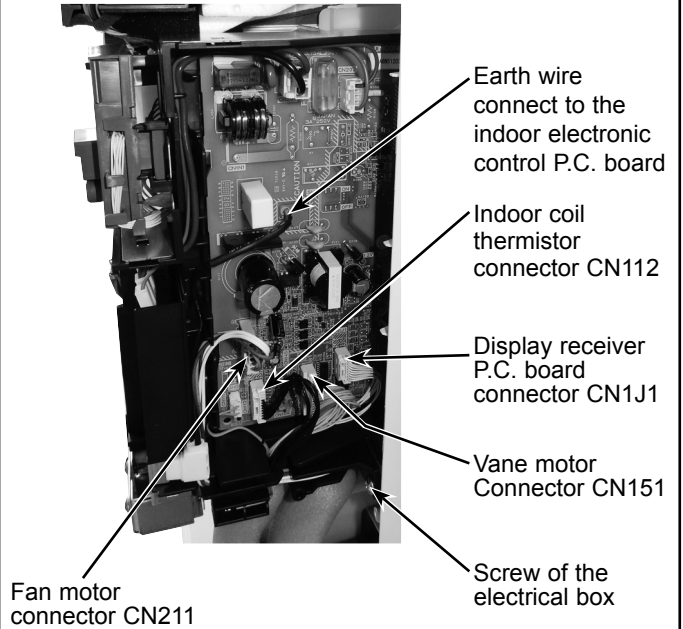
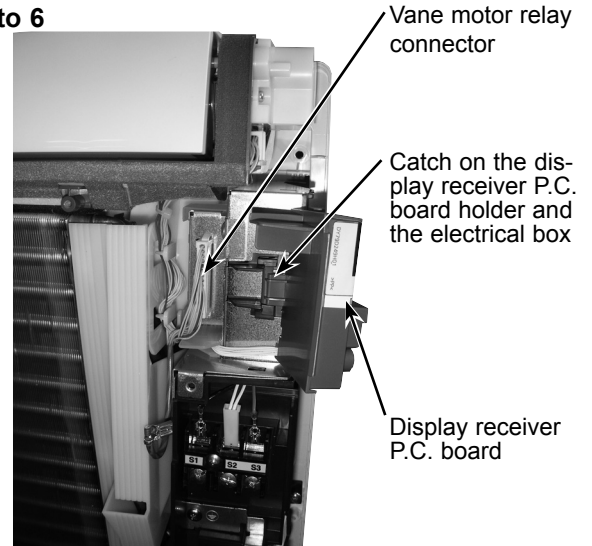
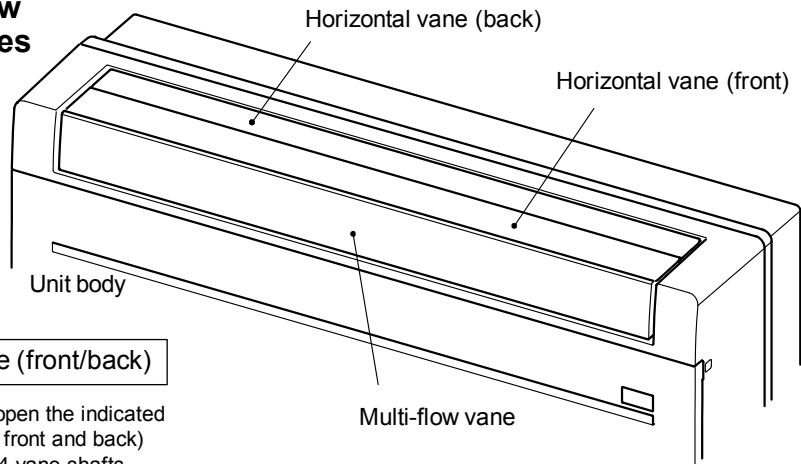

Photo 6



How to remove the multi-flow vane and the horizontal vanes



(1) Removing the horizontal vane (front/back)

(1)-1. See the figure below and push to open the indicated places on the horizontal vanes (between front and back) with your fingers so that you can access 4 vane shafts positioned on the back of the horizontal vanes. (vane shafts on each horizontal vane)

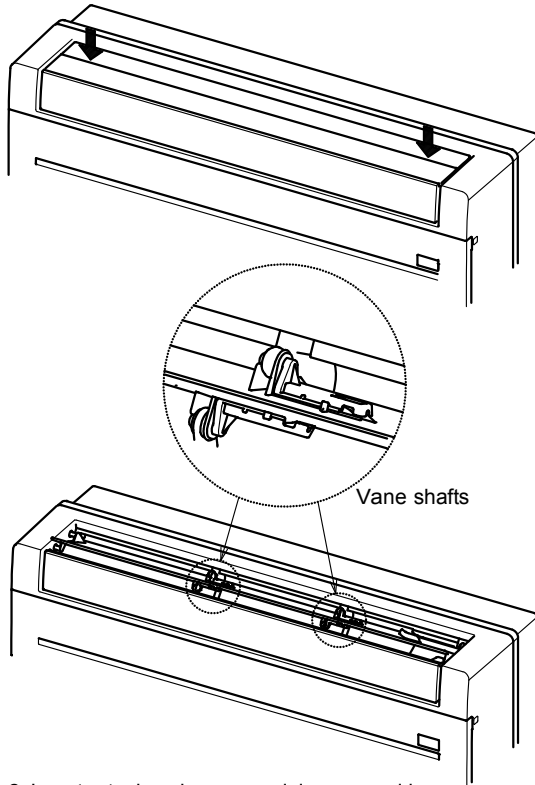

(1)-2. Insert a tool such as a precision screwdriver in the opening on the vane shaft and lift the catch of the vane shaft in arrow 1 direction to detach it from the rib on the horizontal vane. Slide the vane shaft in arrow 2 direction and separate it from the unit body.

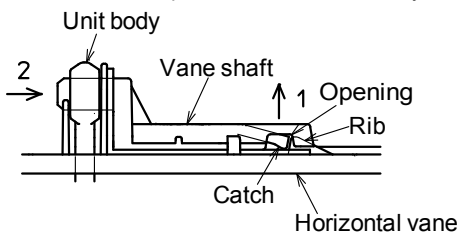

(1)-3. Remove the axial rods on the both ends of the horizontal vane from the unit body.

(2) Removing the multi-flow vane

(2)-1. Open the horizontal vanes (front and back) by following (1)-1. Make sure that 3 vane shafts are on the back of the multi-flow vane.

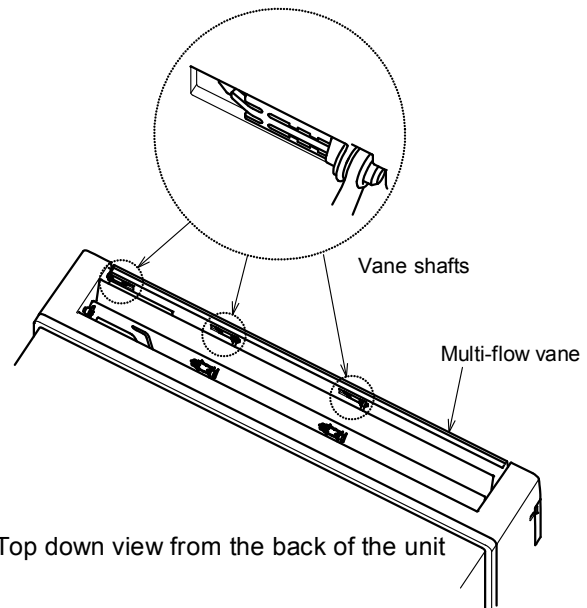

(2)-2. Insert a tool such as a precision screwdriver in the gap between multi-flow vane and the vane shaft and lift the catch of the vane shaft in the arrow 1 direction to detach it from the rib on the multi-flow vane. Slide the vane shaft in arrow 2 direction and separate it from the unit body.

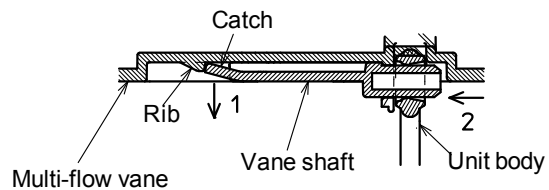

(2)-3. Remove the axial rod on the one end of the multi-flow vane from the unit body.

OPERATING PROCEDURE

5. Removing the horizontal vane motor

- (1) Remove the panel. (Refer to 1.)
- (2) Remove the screws of the horizontal vane motor support and pull out the horizontal vane motor support from the nozzle.
- (3) Remove the screws of the horizontal vane motors.
- (4) Remove the horizontal vane motors from the horizontal vane motor support.
- (5) Disconnect the connectors from the horizontal vane motor.

※ Installing the horizontal vane motor

Connect the connectors to the horizontal vane motors by referring to the colors, red and white, noted on the vane motor support.

6. Removing the multi-flow vane motor unit

- (1) Remove the panel. (Refer to 1.)
- (2) Disconnect the connector from the multi-flow vane motor unit.
- (3) Remove the screws of the multi-flow vane motor unit and pull out the multi-flow vane motor unit from the nozzle.

Photo 12

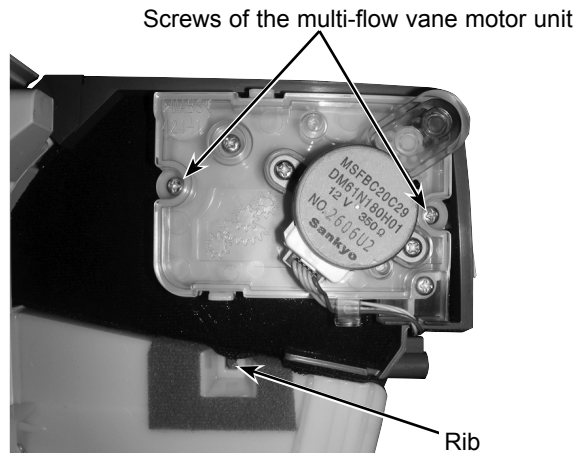

PHOTOS

Photo 9

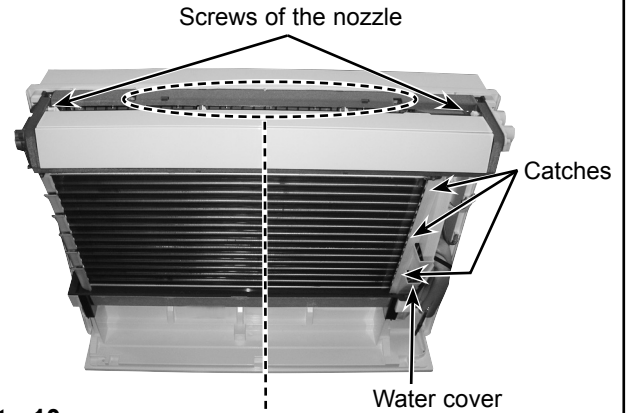

Photo 10

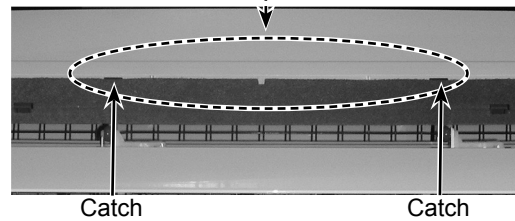
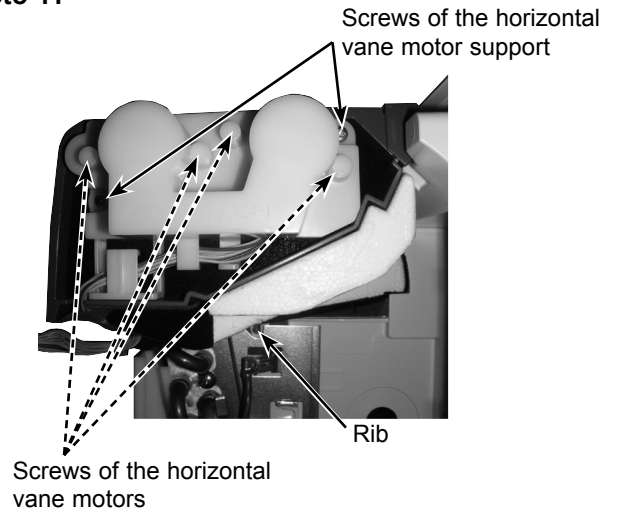

Photo 11



OPERATING PROCEDURE

7. Removing the line flow fan and the indoor fan motor

- (1) Remove the panel. (Refer to 1.)
- (2) Remove the electrical box. (Refer to 2.)
- (3) Remove the nozzle. (Refer to 4.)
- (4) Disengage the water cover from the catches. (Photo 9)
- (5) Remove the screws fixing the motor bed.
- (6) Loosen the screw fixing the line flow fan.
- (7) Remove the motor bed together with the indoor fan motor and the motor band.
- (8) Disengage the catches on the motor band and remove the motor band, and pull out the indoor fan motor.
- (9) Remove the screws fixing the both sides of the heat exchanger.
- (10) Disengage the catch on the right side on the heat exchanger.
- (11) Lift the heat exchanger, and pull out the line flow fan upward.

Photo 16

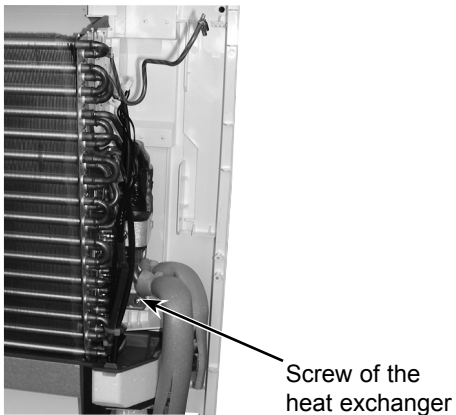

Photo 17



PHOTOS

Photo 13

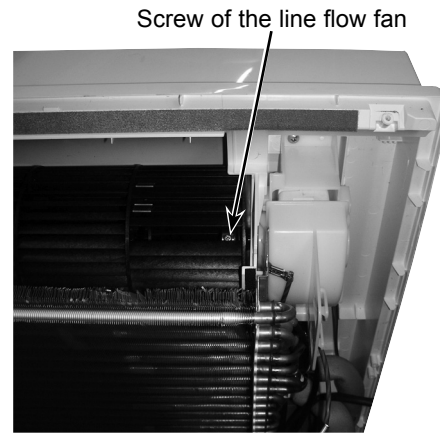

Photo 14

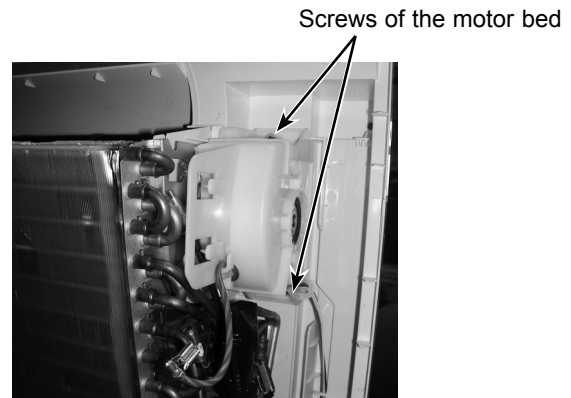
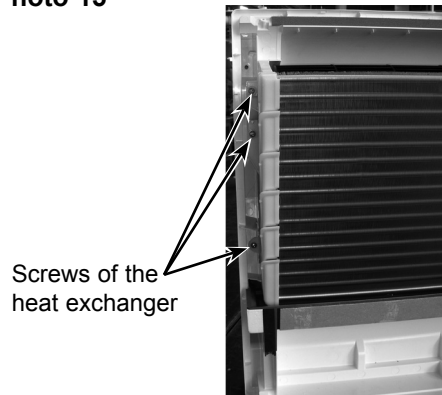

Photo 15



mitsubishi electric corporation

HEAD OFFICE: TOKYO BLDG., 2-7-3, MARUNOUCHI, CHIYODA-KU, TOKYO 100-8310, JAPAN

© Copyright 2016 MITSUBISHI ELECTRIC CORPORATION
Distributed in Mar. 2016. No. OBH752 REVISED EDITION-A
Distributed in Feb. 2016. No. OBH752
Made in Japan

New publication, effective Mar. 2016
Specifications are subject to change without notice.