MIGHTY MAC

Safety & Operating Instructions Gravity Self-Feeding Wood Chipper WC475/475E & WC575E



Serial No. _____

MacKissic

Toll-free phone: (800)-348-1117

Fax: (610)-495-5951

Website: www.MacKissic.com

P/N: 950-2000

Published: 01/14/2020

⚠ DANGER

Read and understand this manual and all instructions before operating or servicing this GRAVITY SELF-FEEDING WOOD CHIPPER.

Table of Contents

Chapter 1: General Safety Rules.....	3
Chapter 2: Setting Up the GRAVITY SELF-FEEDING WOOD CHIPPER.....	9
Chapter 3: Operating Your GRAVITY SELF-FEEDING WOOD CHIPPER	19
Chapter 4: Maintaining the GRAVITY SELF-FEEDING WOOD CHIPPER	25
Chapter 5: Troubleshooting	38
Chapter 6: Accessories.....	42
Chapter 7: Parts List and Schematic Diagrams.	45

Conventions used in this manual

DANGER

This indicates a hazardous situation, which, if not followed, ***will*** result in death or serious injury.

WARNING

This indicates a hazardous situation, which, if not avoided, ***could*** result in death or serious injury.

CAUTION

This indicates a hazardous situation, which, if not avoided, ***could*** result in minor or moderate injury.

NOTICE

This information is important in the proper use of your machine. Failure to follow this instruction could result in damage to your machine or property.

Serial Number and Order Number

A Serial Number is used to identify your machine and is located on the Serial Number Label on your machine. For your convenience and ready reference enter the Serial Number in the space provided on the front cover of this manual.

Additional Information and Potential Changes

MacKissic reserves the right to discontinue, change, and improve its products at any time without notice or obligation to the purchaser. The descriptions and specifications contained in this manual were in effect at printing. Equipment described within this manual may be optional. Some illustrations may not be applicable to your machine.

California Proposition 65

 **WARNING**

CANCER AND REPRODUCTIVE HARM - www.P65Warnings.ca.gov.

Chapter 1: General Safety Rules

WARNING

- Read this Safety & Operating Manual before you use the SELF-FEEDING Wood Chipper. Become familiar with the operation and service recommendations to ensure the best performance from your machine.
- Thoroughly inspect the area in which you will be working and remove all foreign objects. Look for Rope, Wire, ECT., and remove these objects before chipping. Inserting these objects into the chipper hopper could damage the machine and/or cause injury.
- This is a high-powered machine, with moving parts operating with high energy at high speeds. You must use proper clothing and safety gear when operating this machine to prevent or minimize the risk of severe injury. This machine can crush, grind, cut and sever parts of your body if they enter the inlet or discharge area of your chipper.

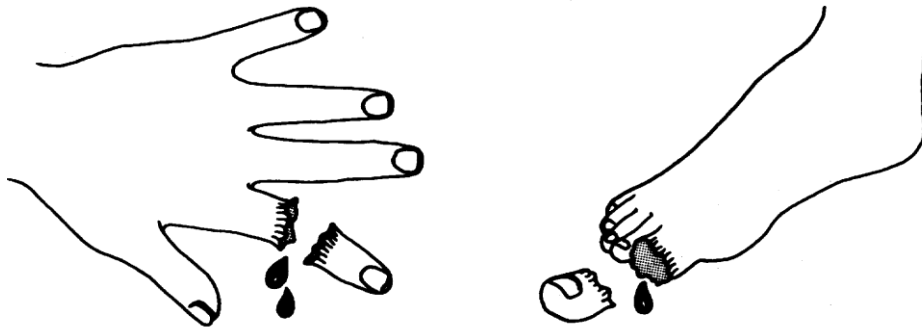

Labels

Your GRAVITY SELF-FEEDING WOOD CHIPPER carries prominent labels as reminders for its proper and safe use. Shown below are copies of all the safety and operation labels that appear on the equipment. Take a moment to study them and make a note of their location on your GRAVITY SELF-FEEDING WOOD CHIPPER as you assemble and before you operate the unit. Replace damaged or missing safety and operation labels immediately.

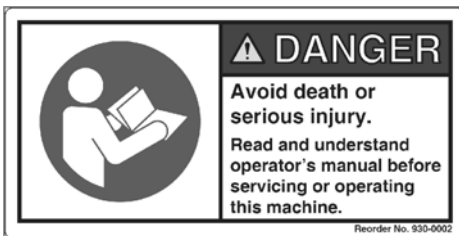

930-0002



930-0007



930-0014

⚠ DANGER

Rotating knife and flywheel can cause death or severe injury.
Do NOT place hands, body parts or other objects in or near the discharge chute while machine is running and parts are moving.
Do NOT start or operate machine without discharge chute in place.
Do NOT try to clear clogs while machine is running and parts are moving.
Shut down engine, wait for all moving parts to come to a complete stop, remove spark plug wire, then wait 5 minutes before opening.

Reorder No. 930-0011

930-0011

⚠ WARNING

Rotating parts inside can cause severe injury.
Shut down engine, wait for all moving parts to come to a complete stop, remove spark plug wire, then wait 5 minutes before opening.

No. 930-0009

930-0009

⚠ WARNING

Rotating parts inside can cause severe injury.
Improper use can cause fire and clutch damage.
Keep hands, body parts and loose clothing clear of this area while machine is running and parts are moving.
Do NOT start or operate machine without all guards in place.
Shut down engine, wait for all moving parts to come to a complete stop, remove spark plug wire, then wait 5 minutes before opening.

Reorder No. 930-0004

930-0004

⚠ WARNING

High speed discharge and debris can cause severe injury.
Stand clear of the discharge chute while machine is running and parts are moving.
Keep bystanders, children, and pets 100 ft. from machine while in use.
Always wear approved safety glasses when using this machine.
Be aware of your surroundings, wind can cause the discharge and debris to change direction.

Reorder No. 930-0010

930-0010

⚠ DANGER

Avoid death or serious injury.
Do NOT tow this machine faster than 10 MPH.
This machine is not legal for street or highway use.

Reorder No. 930-0008

930-0008

⚠ WARNING

Rotating knife and flywheel can cause severe injury.
Do NOT start or operate machine without all guards in place.
Shut down engine, wait for all moving parts to come to a complete stop, remove spark plug wire, then wait 5 minutes before opening.

Reorder No. 930-0001

930-0001

⚠ WARNING

Avoid electric shock.
Sparking from battery cables can cause shock, burns, and damage the machine.
If the battery is removed do NOT operate the machine without insulating the positive (+) battery cable.

Reorder No. 930-0006

930-0006 (Electric Start Model Only)

⚠ DANGER

Avoid death or serious injury.
Do NOT exceed 45 MPH when towing this machine.

Reorder No. 930-0003

930-0003 (Highway Accessory Only)

WARNING: Check Oil Before Starting Engine

091-0043

⚠ DANGER

Avoid death or serious injury.

Rotating cutting blades.
Do NOT insert hands, body parts, or metal objects in the hopper or discharge chute while the machine is running and parts are moving.

Shut down engine, wait for all moving parts to come to a complete stop, remove spark plug wire, then wait 5 minutes before clearing obstruction.

Keep hands, all body parts, and loose clothing away from moving parts.
Always wear approved safety glasses, hearing protection and gloves when using this machine.

Keep stones, nails, and other objects except branches out of the hopper.
Keep bystanders, children and pets 100 ft. from machine while in use.

Do NOT operate machine without the hopper, blow back shield, discharge chute and all guards securely in place.
Read and understand the operator's manual before servicing or operating this machine.

Reorder No. 930-0013

930-0013

Protecting Yourself and Those Around You

WARNING

This is a high-powered machine, with moving parts operating with high energy at high speeds. You must operate the machine safely. Unsafe operation can create a number of hazards for you, as well as anyone else in the nearby area. Always take the following precautions when using this machine:

- Always wear protective goggles or safety glasses with side shields while chipping to protect your eyes from possible thrown debris.
 - Avoid wearing loose clothing or jewelry, which can catch on moving parts or the material fed into the chipper hopper.
 - We recommend wearing gloves while chipping. Be sure your gloves fit properly and do not have loose cuffs or drawstrings.
 - Wear shoes with non-slip treads when using your chipper. If you have safety shoes, we recommend wearing them. Do not use the machine while barefoot or wearing open sandals.
 - Wear long pants while operating the Gravity Self-Feeding Wood Chipper.
 - Use ear protectors or ear plugs rated for at least 20 dba to protect your hearing.
 - Never allow people who are unfamiliar with these instructions to use the chipper. Allow only responsible individuals who are familiar with these rules of safe operation to use your machine.
 - Never place your hands, feet, or any part of your body in the chipper hopper, discharge opening, or near or under any moving part while the machine is running. Keep area of discharge clear of people, animals, buildings, glass, or anything else that will obstruct clear discharge, cause injury, or damage. Wind can also change discharge direction, so be aware. If it becomes necessary to push material into the chipper hopper, use a small diameter stick, not your hands.
 - Keep bystanders 100 feet away from your work area at all times. Wood chips exit the chipper at great speeds. To be safe, do not operate the machine near small children or pets, and never allow children to operate the chipper. Stop the engine when another person or pet approaches.
 - Never use the machine without ensuring that all guards and shields are in place, including the chipper hopper, discharge chute and blowback shield.
 - Do not operate the engine with the air cleaner or the carburetor air intake cover removed. Removal of such parts could create a fire hazard. Do not use flammable solutions to clean the air filter.
 - Always operate the machine from the operator zone (see chapter 3). Never pass or stand on the discharge side of the machine when the engine is running or the flywheel is turning.
 - Never try to pick up, move, or transport the machine while the engine is running or the flywheel is turning.
 - The muffler and engine become very hot and can cause a severe burn; do not touch.
 - Clear the area of objects such as wire and rope, etc. Inserting these objects into the chipper hopper could damage the flywheel and/or cause injury.
 - Never, under any conditions, remove, bend, cut, fit, weld, or otherwise alter standard parts on the MACKISSIC SELF-FEEDING Wood Chipper. This includes all shields and guards. Modifications to your machine could cause personal injuries and property damage and will void your warranty.
-

Safety for Children and Pets

WARNING

Tragic accidents can occur if the operator is not alert to the presence of children and pets. Children are often attracted to the machine and the chipping activity. Never assume that children will remain where you last saw them. Always follow these precautions:

- Keep children and pets at least 100 feet from the working area and under the watchful care of a responsible adult.
 - Be alert and turn the machine off if children or pets enter the work area.
 - Never allow children to operate the Gravity Self-Feeding Wood Chipper.
-

Safety with Gasoline - Powered Machines

WARNING

Gasoline is a highly flammable liquid. Gasoline also gives off flammable vapor that can be easily ignited and cause a fire or explosion. Never overlook the hazards of gasoline. Always follow these precautions:

- Never run the engine in an enclosed area or without proper ventilation as the exhaust from the engine contains carbon monoxide, which is an odorless, tasteless, and deadly poisonous gas.
 - Store all fuel and oil in containers specifically designed and approved for this purpose and keep away from heat and open flame, and out of the reach of children.
 - Replace rubber fuel lines and grommets when worn or damaged and after 5 years of use.
 - Fill the gasoline tank outdoors with the engine off and allow the engine to cool completely. Don't handle gasoline if you or anyone nearby is smoking, or if you're near anything that could cause it to ignite or explode. Reinstall the fuel tank Cap and fuel container cap securely.
 - If you spill gasoline, do not attempt to start the engine. Move the machine away from the area of the spill and avoid creating any source of ignition until the gas vapors have dissipated. Wipe up any spilled fuel to prevent a fire hazard and properly dispose of the waste.
 - Never make adjustments or repairs with the engine running. Shut down the engine, disconnect the spark plug wire, keeping it away from the spark plug to prevent accidental starting, wait 5 minutes before making adjustments or repairs.
 - Never tamper with the engine's governor setting. The governor controls the maximum safe operation speed and protects the engine. Over-speeding the engine is dangerous and will cause damage to the engine and to the other moving parts of the machine. If required, see your authorized dealer for engine governor adjustments.
 - Keep your hands and combustible substances away from the engine when it is hot and clean the engine area after each use.
 - To reduce fire hazard, keep the engine cooling fins and muffler area free of debris build-up such as leaves, grass, oil, grease or any other combustible material.
 - Never cover the machine while the muffler is still hot.
 - Do not operate the engine with the air cleaner or the carburetor air intake cover removed, except for adjustment. Removal of such parts could create a fire hazard.
 - Do not use flammable solutions to clean the air filter.
 - The muffler and engine become very hot and can cause a severe burn; do not touch.
-

Road Towing Safety (For Highway Accessory Only)

CAUTION

- Before towing, be certain the Gravity Self-Feeding Wood Chipper is correctly and securely attached to the towing vehicle and the safety chains are in place. Leave slack in the chains to allow for turning.
 - Never allow anyone to ride on the Gravity Self-Feeding Wood Chipper.
 - Never transport anything on the machine.
 - Obey local, state, and federal regulations when you tow the chipper on public roads and highways.
 - Note: Some states may require the machine to be registered with the state department of motor vehicles.
 - Allow for added length in driving situations, e.g., when turning, parking, and crossing intersections.
 - Adjust your towing speed for terrain and conditions. Do not exceed 45 mph while towing the chipper.
 - Towing the machine can affect handling of the tow vehicle:
 - The chipper might track at an angle to the tow vehicle.
 - The machine can turn tighter than the tow vehicle.
 - Never back up the tow vehicle with the chipper attached. The machine can jackknife, causing damage to itself and/or the tow vehicle.
 - Long distance towing is not recommended. The Gravity Self-Feeding Wood Chipper does not have springs to absorb road shock and will tend to bounce on rough roads. Extended towing can cause unnecessary wear.
-

General Safety

DANGER

Operating this chipper safely is necessary to prevent or minimize the risk of death or serious injury. Unsafe operation can create a number of hazards for you. Always take the following precautions when operating this chipper:

- Keep in mind that the operator or user is responsible for accidents or hazards occurring to other people, their property, and themselves.
 - Your Gravity Self-Feeding Wood Chipper is a powerful tool, not a plaything. Exercise extreme caution at all times. The design of this machine is to chip wood. Do not use it for any other purpose.
 - Ensure you know the steps on how to stop the chipper properly (see chapter 3).
 - Operate this machine on a level surface only. Never operate your unit on a slippery, wet, muddy, or icy surface. Exercise caution to avoid slipping or falling.
 - Keep your face and body back from the chipper hopper to avoid accidental bounce back of any material.
 - When feeding material into the chipper hopper, be extremely careful that pieces of metal, rocks, or other foreign objects are not included. Personal injury or damage to the machine could result.
 - Never allow an accumulation of processed material to build up in the discharge area as this will prevent proper discharge and can result in kickback from the chipper hopper.
 - Always stop the engine when moving the Gravity Self-Feeding Wood Chipper.
 - Keep combustible substances away from the engine when it is hot.
 - Never cover the machine while the muffler is still hot.
 - See manufacturer's instructions for proper operation and installation of accessories. Only use accessories approved by MacKissic.
-

General Safety Continued

DANGER

- If the cutting mechanism strikes a foreign object or if your machine should start making an unusual noise or vibration, shut down the engine, wait for all moving parts to come to a complete stop (the flywheel will continue rotating for a while after the engine is shut down), disconnect spark plug wire, keeping it away from the spark plug to prevent accidental starting, then wait 5 minutes before inspecting for clogging or damage. Vibration is generally a warning of trouble. Clean and repair and/or replace damaged parts.
 - Never tamper with safety devices. Check their proper operation regularly.
 - Stay alert for hidden hazards or traffic. Never carry passengers on your machine.
 - Never overload or attempt to chip material beyond the manufacturer's recommendation; see chapter 3. PERSONAL INJURY or damage to the machine could result.
 - While using the Gravity Self-Feeding Wood Chipper, don't hurry or take things for granted. When in doubt about the equipment or your surroundings, stop the machine and take the time to look things over.
 - Never operate the machine when under the influence of alcohol, drugs, or medication.
 - Use the machine only in daylight.
 - Keep all nuts and bolts tight and keep the equipment in good operating condition.
-

A Note to All Users

Under California law, and the laws of some other states, you are not permitted to operate an internal combustion engine using hydrocarbon fuels without an engine spark arrester. This also applies to operation on US Forest Lands. All GRAVITY SELF-FEEDING WOOD CHIPPERS shipped to California, New Mexico and Washington State are provided with spark arresters. Failure of the owner or operator to maintain this equipment in compliance with state regulations is a misdemeanor under California law and may be in violation of other state and/or federal regulations. Contact your local fire marshal or forest service for specific information in your area.

No list of warnings and cautions can be all-inclusive. If situations occur that are not covered by this manual, the operator must apply common sense and operate this Gravity Self-Feeding Wood Chipper in a safe manner. Contact us at www.MacKissic.com or call (800)-348-1117 for assistance.

Chapter 2: Setting Up the GRAVITY SELF-FEEDING WOOD CHIPPER

This chapter outlines assembly and a few simple steps you will need to follow to set up your new machine before you use it. It may be helpful to familiarize yourself with the controls and features of your GRAVITY SELF-FEEDING WOOD CHIPPER as shown in **Figure 1** before beginning these procedures. If you have any questions at all, please feel free to contact us at www.MacKissic.com or call our Customer Service Representatives at our toll free number: (800)-348-1117.

GRAVITY SELF-FEEDING WOOD CHIPPER Controls and Features



Figure 1

Specifications

Models	WC475 Manual and Electric Start Models	WC575E
Engine	Briggs & Stratton (See Engine Manual for Engine Specifications)	Briggs & Stratton Electric Start (See Engine Manual for Engine Specifications)
Series	XR1650	XR2100
Chipping Capacity	4-3/4" Diameter	5-3/4" Diameter
Number of Chipper Knives	1	1
Chipper Knife Size	6-1/4" x 1-1/4" x 9/32"	7-1/4" x 1-1/4" x 9/32"
Chipper Knife Material	Heat Treated Tool Steel	Heat Treated Tool Steel
Adjustable Wear Plate	Yes	Yes
Chipper Flywheel	17-3/4" Diameter x 5/8" Thick	20" Diameter x 3/4" Thick
Flywheel Weight	53 Lbs	80 Lbs
Chipper Knife Tip Speed	128 mph	144 mph
Wheel Size	4.10/3.50-6 Pneu. (Standard) 4.80/4.00-8 Pneu. (Highway Models)	4.10/3.50-6 Pneu. (Standard) 4.80/4.00-8 Pneu. (Highway Models)
Axle	3/4" Diameter (Standard) 1" Diameter w/Welded Angle (Highway Accessory)	3/4" Diameter (Standard) 1" Diameter w/Welded Angle (Highway Accessory)
Hopper Material	10 GA Neck, 16 GA Hopper, Steel	10 GA Neck, 16 GA Hopper, Steel
Frame Material	10 GA Steel, 2"x2" Structural Angle	10 GA Steel, 2"x2" Structural Angle
Hopper Opening at Top	17" x 27"	19" x 30-1/2"

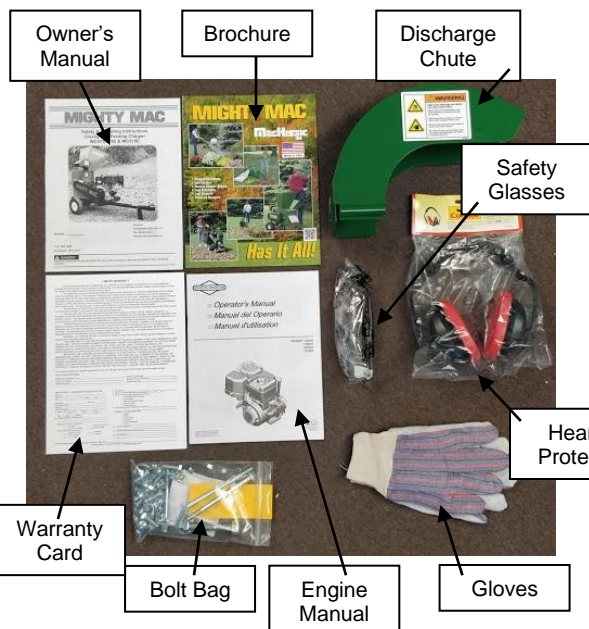

Figure 2

Assembly

Parts supplied in Shipping Container:

- Gravity Self-Feeding Wood Chipper
- Hopper Assembly
- Tow Bar
- Extended Top-Discharge Chute (if ordered, see Chapter 6 "Chipper Accessories")
- Parts Box containing (**Figure 2**):
 - Discharge Chute
 - Front Tongue Bracket, Rear Tongue Bracket, Hitch Plate
 - Safety Glasses, Gloves, and Hearing Protection
 - *Safety & Operation Instructions* Manual
 - Engine Owner's Manual
 - Hardware Package (**Figure 3 and Table on next page**)
 - Warranty Card and Brochure

Hardware Package Parts:

	PART NUMBER	DESCRIPTION	QTY	WHERE USED
1	090-0639	5/16-18 THIN NYLOCK NUTS	8	HOPPER
2	090-0748	5/16-18 X 3/4" TRUSS BOLTS	8	HOPPER
3	090-0475	5/16-18 SAE FLATWASHERS	8	HOPPER
4	090-0702	5/16-18 X 4-1/2" HHCS	2	DISCHARGE
5	090-0460	5/16-18 NYLOCK NUTS	2	DISCHARGE
6	090-0088	5/16-18 X 1" HHCS	2	HITCH BRKT
7	090-0460	5/16-18 NYLOCK NUTS	2	HITCH BRKT
8	090-0610	1/4-20 U BOLT	1	AXLE
9	090-0470	1/4-20 NYLCOK NUT	2	AXLE
10	090-0110	3/8-16 X 1" HHCS	5	TOW TONGUE & BRKTS
11	090-0461	3/8-16 NYLOCK NUT	5	TOW TONGUE & BRKTS
12	090-0116	3/8-16 X 3" HHCS	1	SUPPORT LEG
11	090-0461	3/8-16 NYLOCK NUT	1	SUPPORT LEG
13	090-0749	HAIR COTTER PIN	1	SUPPORT LEG
14	706-0924	HAIR COTTER	1	SUPPORT LEG
15	090-0012	1/4-20 X 3/4" HHCS	2	BATTERY (WC575E)
9	090-0470	1/4-20 NYLOCK NUTS	2	BATTERY (WC575E)
16	090-0232	1/4 USS FLAT WASHERS	4	BATTERY (WC575E)

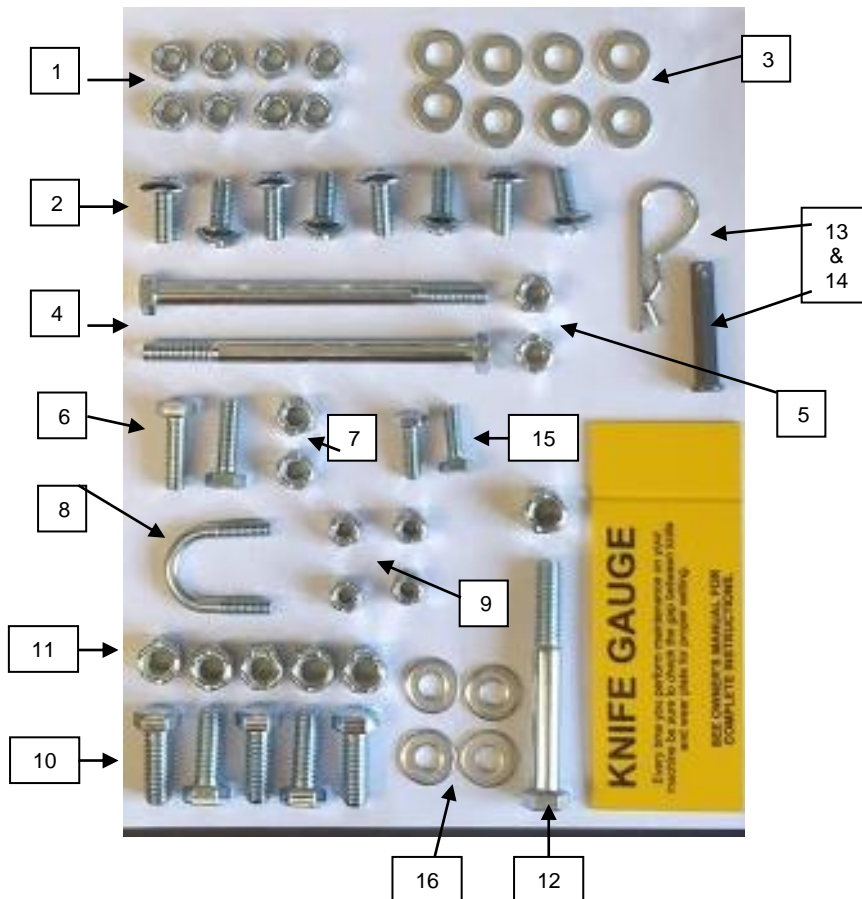

Installing the Tow Bar

Note: For easier installation, keep the machine on the pallet and supports until the Tow Bar is installed.

Tools Needed:

- 7/16 Wrench
- Two 9/16" Wrenches
- Two 1/2" Wrenches

1. Position the Tow Bar under the Base and secure the front Bracket with two 3/8-16 x 1" Bolts and Locknuts using two 9/16" Wrenches (**Figure 4**).
2. Secure the Bracket at the rear of the Tow Bar to the Axle with a U-Bolt and two Locknuts using a 7/16" Wrench. (**Figure 5**).
3. Attach the Hitch Plate to the Tow Bar with Two 5/16-18 x 1" Bolts and Locknuts using two 1/2" Wrenches (**Figure 6**).

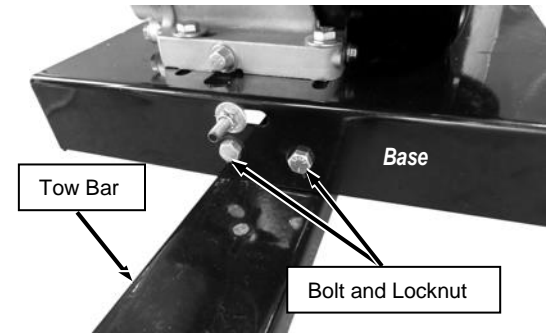
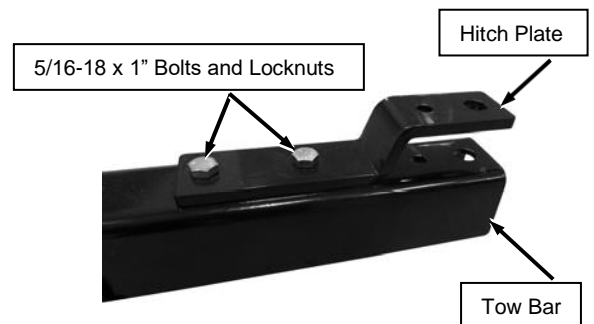
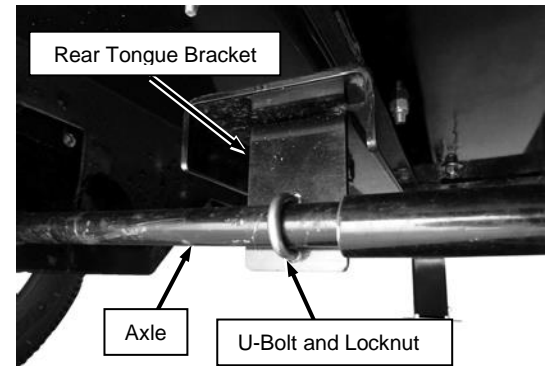

Figure 4



Installing the Tow Bar and Lights for the Highway Accessory

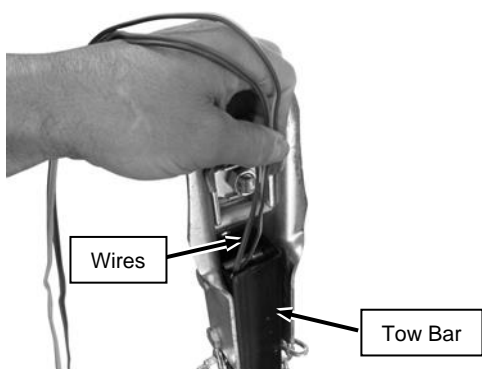

Figure 7

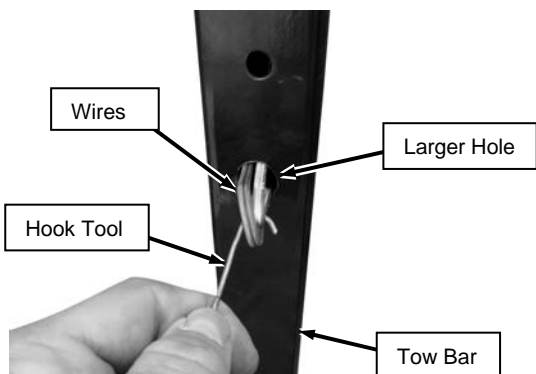

Figure 8

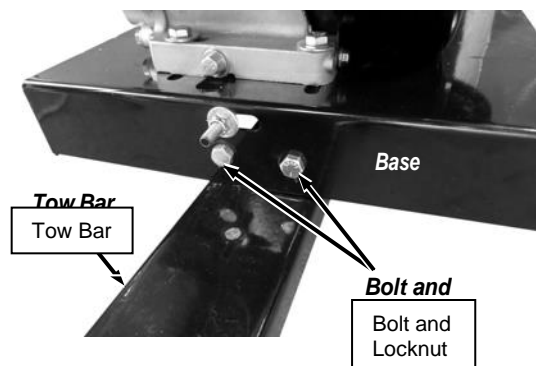

Figure 9

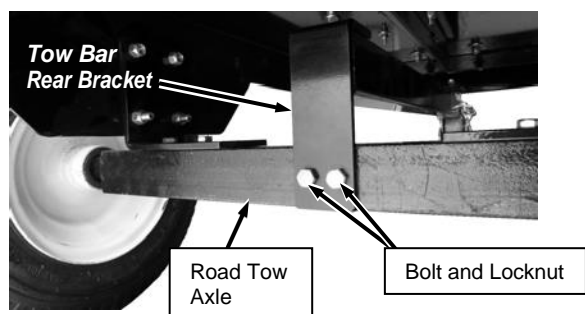

Figure 10

Note: For easier installation, keep the machine on the pallet and supports until the Tow Bar is installed.

Tools and Supplies Needed:

- 7/16 Wrench
- Two 1/2" Wrenches
- Two 3/4" Wrenches
- Wire strippers/Cutters
- Stiff Wire with Hooked End
- Cable Ties (Supplied with machine)

1. Insert the ends of the Yellow/Brown and Green/Brown Wires of the Wire Harness into the Tongue Assembly and down into the Tow Bar (**Figure 7**) until they reach the large hole (**Figure 8**).
2. Pull the ends of the wires through the large Hole by using a stiff wire with a small hook formed at the end.
3. Continue pulling the Wires through leaving approximately two feet of the Plug end extended beyond the front of the Tongue assembly.
4. Position the Tow Bar under the Base and secure the front Bracket with 3/8- 16 x 1" Bolts and Locknuts using two 9/16" Wrenches (**Figure 9**).
5. Secure the rear of the Tow Bar to the Axle with 3/8-16 x 1" Bolts and Locknuts using two 9/16" Wrenches (**Figure 10**).
6. Position the Yellow/Brown Wires along the left side of the axle and up to the light location over the Fender (**Figure 11**).
7. Position the Green/Brown Wire along the right side of the axle and up to the Light location over the Fender.
8. Secure the Wires under the Frame with Cable Ties at the four places shown.

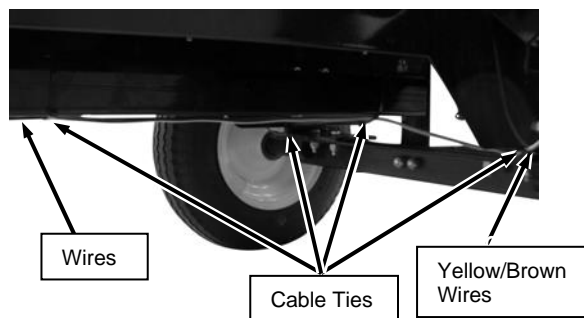

Figure 11

9. Mount a Light Bracket to both sides of the Chipper with two 5/16-18 x 3/4" Bolts and Locknuts each using two 1/2 Wrenches (**Figure 12**).
10. Attach the Lights to the mounting brackets with the Locknuts that are included on the Lights using a 7/16" Wrench.

Note: The Side Light of each Light Assembly must face to the outside of the Chipper with the clear Lens facing down.

11. Secure the Wires to the Light Brackets with a Cable Tie.
12. Cut the wires with Wire Cutters near the top of the Light allowing enough extra Wire for installation into the back of the Light after Wires are stripped in the next step.
13. Strip (remove) 1/2" of insulation from the ends of the Yellow/Brown wires and Green/Brown wires with Wire Strippers and twist the individual wire ends to aid in installation.
14. At the left side of the Chipper, insert the Yellow Wire into the top left hole in the back of the light socket. Insert the Brown Wire into the top right hole.

Note: The wires are retained in the light socket holes by spring-loaded connectors.

15. At the right side of the Chipper, insert the Green Wire into the top left hole in the back of the light socket. Insert the Brown Wire into the top right hole.
16. Remove 1" of insulation from the end of the White (Ground) Wire with the Wire Strippers (**Figure 13**).
17. Loosen a Trailer Hitch Bolt, wrap the White (Ground) Wire around the Bolt, and then re-tighten with two 3/4" wrenches.
18. Secure the Wires to the Tongue Assembly between the two large Bolts to ensure they will not get caught between the Tongue and Ball of the Tow vehicle (**Figure 14**).
19. Secure the colored and white wires together with a couple of Cable Ties.

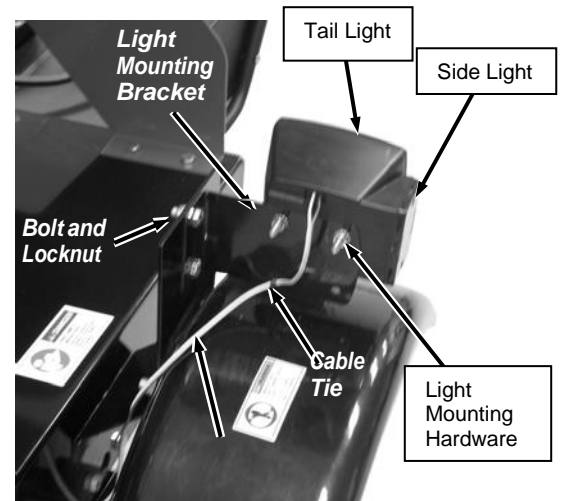

Figure 12

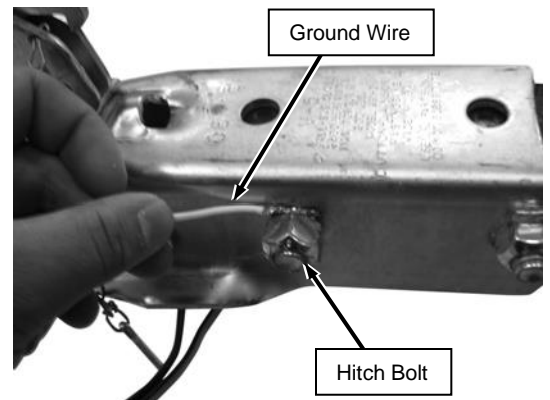

Figure 13



NOTICE

Always secure the Support Leg in the up (transport) position before towing to prevent damage to the machine.

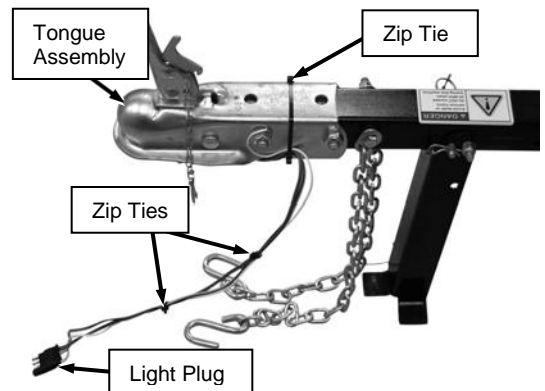

Figure 14

Attaching the Hopper Assembly

Note: We recommend that you have someone help you lift the Hopper in place and support it until it is secured to the Chipper.

Tools Needed:

- One 1/2" Wrench and One Phillips Head Screwdriver



Figure 15

1. Gather x8 5/16-18 x 3/4" Truss Head Bolts, x8 5/16-18 Thin Nylon Locknuts, and x8 5/16 SAE washers from your Bolt Bag.
2. Place the Hopper Assembly inside of the Hopper Neck.
3. From the inside of the Hopper Assembly, insert a Truss Head Bolt through the holes (x4 each side of Hopper), place a 5/16 SAE washer over the protruding bolt threads, and secure using a Thin Nylon Locknut on the outside (**Figure 15**).

Note: The head of the Truss Head Bolt should be inside of the Hopper creating a smooth inlet for material feeding.

Attaching the Discharge Chute

Tools Needed:

- Two 1/2" Wrenches

1. Loosen the two 4-1/2" long 5/16-18 Bolts holding the scroll.
2. Position the Discharge Chute facing away from the Hopper as shown and secure with two 4-1/2" long 5/16-18 Bolts, Washers (one Washer on Bolt side and one on Locknut side) and Locknuts using two 1/2" Wrenches (**Figure 16**).
3. Re-tighten the two 4-1/2" long 5/16-18 Bolts that hold the scroll from step 1.

Positioning the Support Leg from Towing to Operating Position

1. Pull the Hitch Clip from the Pin and pull the Pin from the Support Leg and Tow Bar (**Figure 17**).
2. Rotate the Support Leg to the down (operating) position, align the holes in the Tow Bar and Leg, reinstall the Pin and secure with the Hitch Clip (**Figure 18**).

Connecting the Battery Cable (Electric Start)

We ship the electric-start GRAVITY SELF-FEEDING WOOD CHIPPER with the negative terminal battery cable disconnected. This prevents the battery from discharging

during shipment. Before using your electric start GRAVITY SELF-FEEDING WOOD CHIPPER, you must connect the battery cable.

Tools Needed:

- Two 7/16" Wrenches

1. Connect the Negative Battery Cable onto the Negative Terminal Lug of the Battery with the 1/4-20 x 3/4 Bolt, 1/4 Washer and 1/4-20 Nut using the two 7/16 wrenches. (**Figure 19**).

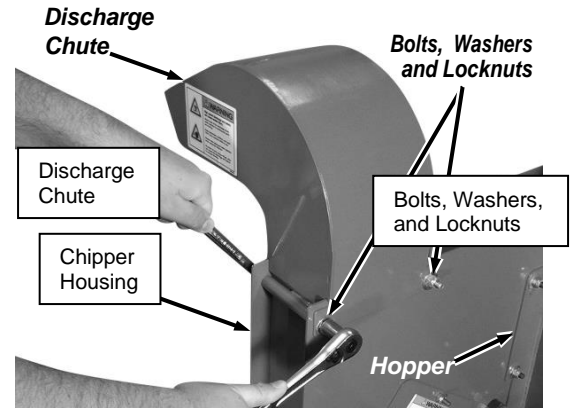
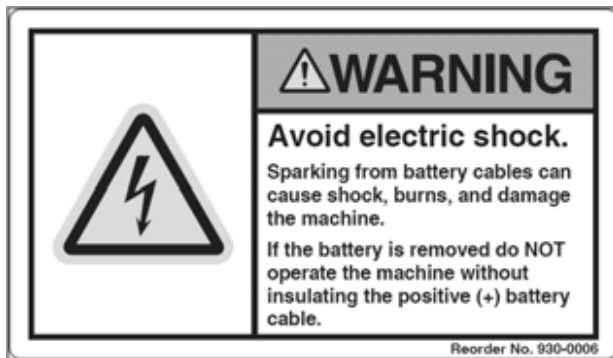
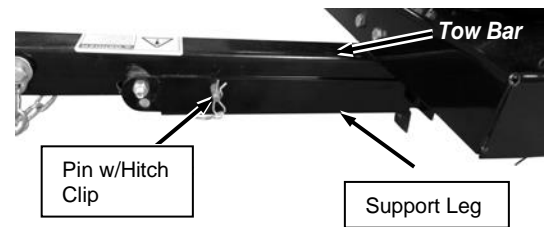

Figure 16



Support Leg

Figure 17

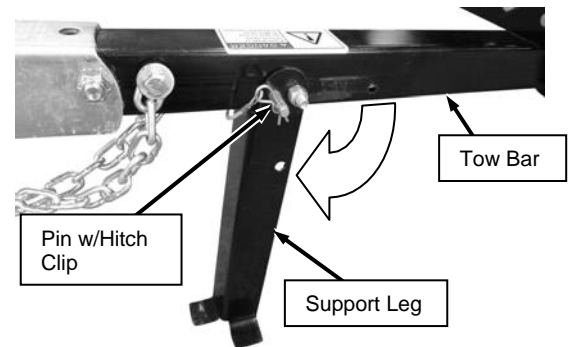

Figure 18

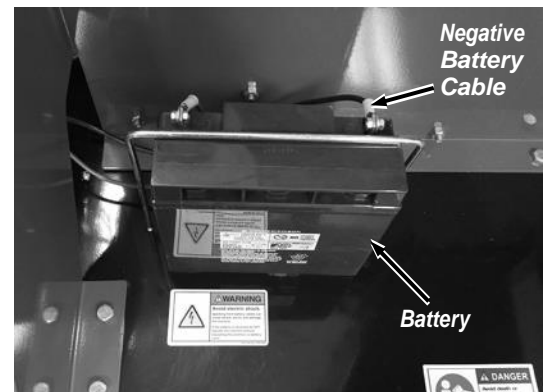

Figure 19

Adding Engine Oil and Gasoline

Capacities	
Engine	See engine owner's manual
Fuel Tank	Unleaded gasoline, 4 US quarts (3.79L)

Tip: To avoid confusion, we recommend leaving the caps on the gas and oil fills until you are ready to pour either gasoline or oil into the correct fill.

Note: Use SAE 30 high detergent oil classified "For Service SF, SG, SH, SJ" or higher. Do not use special additives. Other types of oil could cause problems operating your machine. Please refer to your Engine Owner's Manual for detailed oil information.

NOTICE

- You must add oil before starting the engine. This machine is shipped without oil. Traces of oil may be in the reservoir from factory testing, but you must add oil before starting the engine. Fill the reservoir slowly checking the dipstick frequently to avoid overfilling.
- To get an accurate reading when checking the oil level:
 - The machine should be on a level surface.
 - The dipstick **should** be pushed all the way down and turned a quarter turn clockwise for the WC475 Model (long Dipstick) to ensure an accurate oil level reading.
 - The dipstick **should not** be screwed in for the WC575E Model (short Dipstick) to ensure an accurate oil level reading.

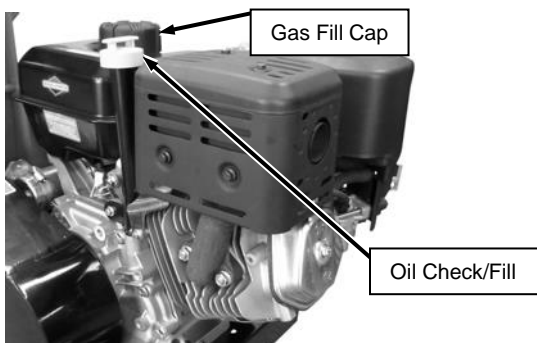

Figure 20a: WC475 Model

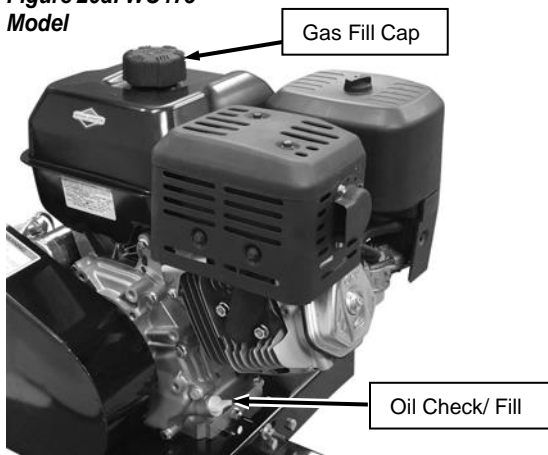

Figure 20b: WC575E Model

Adding Oil

- Place the machine on a level surface and remove the Dipstick (clean the end of the Dipstick with a rag) (**Figure 20a and 20b**).
- Machines are shipped with no oil. Add 1/2 of the SAE 30 high detergent oil recommended by the engine manufacturer and wait one minute for the oil to settle.
- WC475 Model:** Install the Dipstick fully and turn a quarter turn clockwise to ensure an accurate reading and then remove it to check the oil level.
WC575E: Insert the Dipstick, but do not screw in, to ensure an accurate reading and then remove it to check the oil level.

WARNING: Check Oil Before Starting Engine

- If the oil level is low, continue adding a few ounces of oil at a time, rechecking the Dipstick until the oil reaches the fill mark (**Figure 21a and 21b**). Be careful not to overfill.
- Install the Dipstick completely when finished.

Adding Gas

- Remove the Gas Fill Cap and fill the Gas Tank with fresh, unleaded gas (with a minimum of 85 Octane) to approximately 1" to 1-1/2" below the top of the fill neck to allow for fuel expansion. Be careful not to overfill and reinstall the Gas Fill Cap before starting the engine. See your Engine Owner's Manual for more detailed information.

Note: To refill the gas tank, turn the engine OFF and let the engine cool at least five minutes before removing the gas fill cap.

Check the Tire Pressure (Highway Kit Only)

Tools Needed:

- Tire Pressure Gauge
- Air Compressor

- Remove the Valve Stem Protective Cap and check the tire pressure with a Tire Pressure Gauge (**Figure 22**).
- If the pressure is too low, add air through the Valve Stem with an air hose.

⚠ WARNING

Do not over inflate the tires. Inflate to the manufacturers recommended pressure found on the tires.

- Replace the Valve Stem Protective Cap when finished.

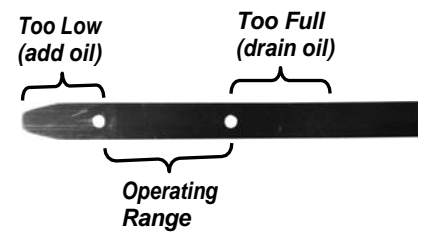

Figure 21a: WC475 Model

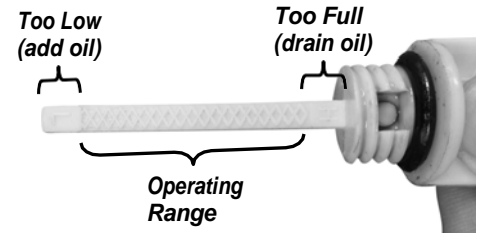

Figure 21b: WC575E Model

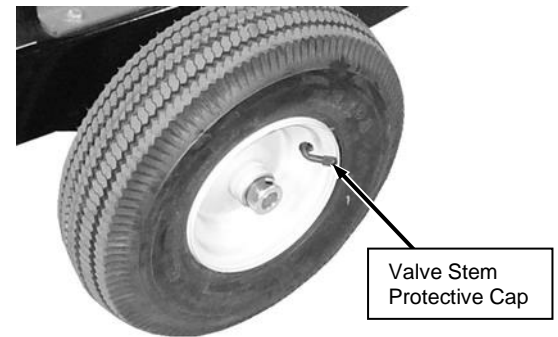

Figure 22: Highway Wheels Only

Chapter 3: Operating Your GRAVITY SELF-FEEDING WOOD CHIPPER

This chapter covers the procedures for starting and stopping your new GRAVITY SELF-FEEDING WOOD CHIPPER and discusses basic operation features.

! DANGER

- The design of this machine is for chipping wood. Never use this machine for any other purpose as it could cause serious injury.
- Contact with internal rotating parts will cause serious personal injury. Never put hands, face, feet, or clothing into chipper hopper or discharge opening or near the discharge area at any time.
- Before performing any maintenance procedure or inspection, shut down the engine, wait for all moving parts to come to a complete stop (The flywheel will continue rotating for a while after the engine is shut down), disconnect spark plug wire, keeping it away from the spark plug to prevent accidental starting, disconnect the negative battery cable, then wait 5 minutes before proceeding.
- Use only a wooden stick to clear jammed material.

Before Starting the Engine

1. Check the oil level every time you use the GRAVITY SELF-FEEDING WOOD CHIPPER. Add oil if needed (see Chapter 2 section “Adding Engine Oil and Gasoline”).
2. Check the fuel level. Add fuel as needed (see Chapter 2 section “Adding Engine Oil and Gasoline”).
3. Ensure that the Fuel Shut-Off Valve is in the “ON” position (**Figure 23**).
4. Remove any debris buildup from the machine before every use of the Chipper.

Note: Check and re-tighten the Drive Belt, if necessary, after an initial break-in period of one (1) hour (see Chapter 4 “Maintaining the GRAVITY SELF-FEEDING WOOD CHIPPER”).

Operation Notes

- Visually check the Chipper Knife for damage before each use of the machine. See “VISUAL inspection of the Chipper Knife (before each use)” in Chapter 4 for info on accessing the Chipper Knife.
- At engine start-up, the engine of your MIGHTY MAC CHIPPER operates under no load until approximately 1800 RPM, at which speed the Centrifugal Clutch engages and begins driving the Rotor Assembly. Always operate the Engine at full speed when chipping.
- Only operate the GRAVITY SELF-FEEDING WOOD CHIPPER from the Operator Zones shown (**Figure 24**).
- Keep proper balance and footing while operating the GRAVITY SELF-FEEDING WOOD CHIPPER.
- ALWAYS stop the engine when leaving the Operating Zones or when moving the machine.
- Never move the Chipper while the engine is running or the Flywheel is turning.

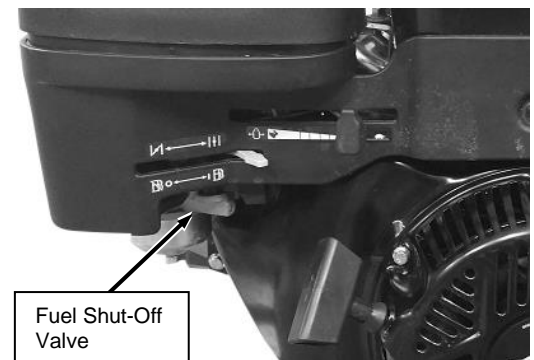

Figure 23

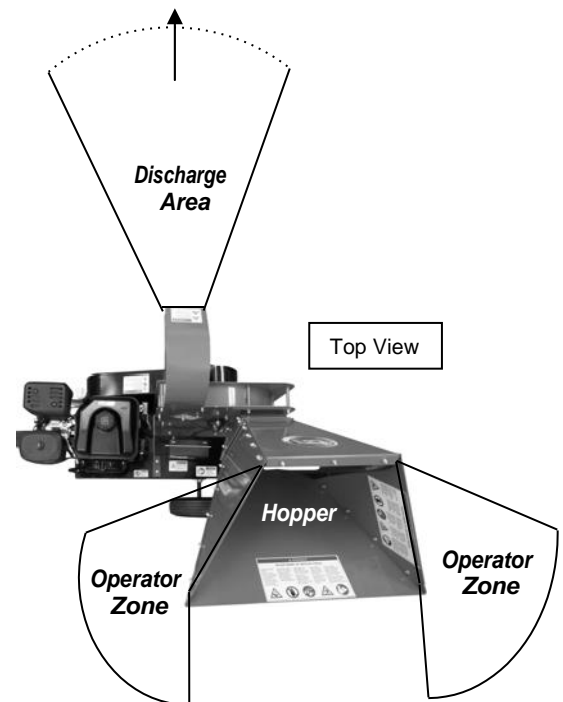

Figure 24

Processing Material

WARNING

- Always wear protective goggles or safety glasses with side shields while chipping to protect your eyes from possible thrown debris.
 - Avoid wearing loose clothing or jewelry, which might catch on moving parts or the material fed into the chipper hopper.
 - We recommend wearing gloves while chipping. Be sure your gloves fit properly and do not have loose cuffs or drawstrings.
 - Wear shoes with non-slip treads when using your chipper. If you have safety shoes, we recommend wearing them. Do not use the machine while barefoot or wearing open sandals.
 - Wear long pants while operating the GRAVITY SELF-FEEDING WOOD CHIPPER.
 - Use ear protectors or ear plugs rated for at least 20 dba to protect your hearing.
-

The Chipper is designed to accept wood only. The Chipper Knife mounted on a revolving flywheel turns branches fed into the Chipper Hopper into “chips”. Cut your materials into manageable lengths before feeding them into the Chipper Hopper.

WARNING

The chipper hopper must be securely bolted to your GRAVITY SELF-FEEDING WOOD CHIPPER and the blowback shield in place before using the machine!

NOTICE

Use common sense when using the Machine. Learn to recognize the change in sounds when overloaded. Turn Off the Engine immediately if the machine becomes jammed to prevent damage to the Drive System

- Your GRAVITY SELF-FEEDING WOOD CHIPPER can process dry or green wood up to 4-3/4" (WC475) or 5-3/4" (WC575E) in diameter.
 - The Chipper will self-feed the wood once it contacts the knife edge so forcing the branches into the Hopper is not necessary if the knife is sharp.
 - Green wood will process quicker and easier than dry wood.
 - Softwood processes easier than hardwood.
 - Your operator experience will teach you how different types of wood will chip and how fast you can process them.
 - When chipping branches, sometimes a tail will develop at the end of a branch. To avoid this, rotate the branch while feeding it into the Chipper Hopper.
 - Rotating the branch as you feed it into the machine will improve chipping performance.
 - Use caution with small diameter green saplings and branches less than 2" in diameter. Chip these grouped or bundled together to provide support for each other. If the material is 2" or larger, feed only one at a time into the Chipper Hopper.
 - Make sure the GRAVITY SELF-FEEDING WOOD CHIPPER finishes processing material in the Hopper before shutting the engine off.
 - Do not force material into the Chipper. If the machine does not chip well, the Chipper Knife may need sharpening or replacement, or the gap between the Knife and the Wear Plate needs adjusting. See “Removing, Replacing and Adjusting the Chipper Knife and Wear Plate” in Chapter 5.
-

NOTICE

Never throw remaining Stubs or Knots into the Chipper Hopper; Damage will Result.

- Extremely hard knots will not process very well. Push any short stubs that have not self-fed through the Chipper, with the next branch to be chipped.
- Cut the material to be chipped into manageable lengths of no more than five or six feet long before chipping them.
- Overloading the Chipper Hopper will cause the rotor speed to decrease. If you hear the engine RPM decreasing, stop feeding material into the Chipper Hopper until the engine has returned to full speed.

Starting the Engine (Manual Start Model)

1. Ensure that the Fuel Shut-Off is in the “ON” position to the right (**Figure 25**).
2. Move the Choke Control Lever to the “CHOKE” position to the left (leave in the RUN position to the right if the engine is already warm).
3. Move the Throttle Control Lever to about half way between Slow (turtle) and Fast (rabbit) position.
4. Pull the slack out of the Starter Cord until you feel resistance, then pull quickly.
The cord will recoil back into position (**Figure 25**).
5. As the engine warms up, slowly adjust the Choke to the “Run” position. Wait until the engine runs smoothly before each Choke adjustment.
6. When the Engine is warmed up and running smoothly with the Choke in the “RUN” position, move the Throttle Control Lever to the fast (rabbit) position for chipping.

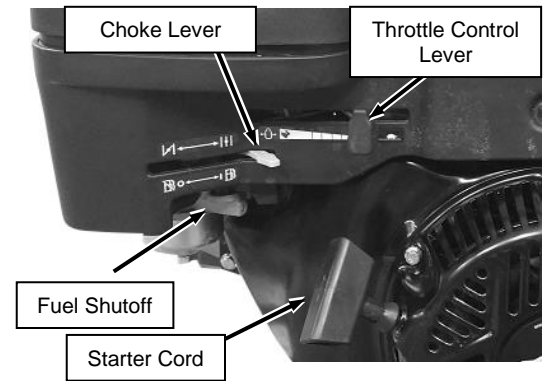

Figure 25

Starting the Engine (Electric Start Model)

1. Ensure that the Fuel Shut-Off is in the “ON” position (**Figure 26**).
2. Move the Choke Control Lever to the “CHOKE” position to the left (leave in the RUN position to the right if the engine is already warm).
3. Move the Throttle Control Lever to about half way between Slow (turtle) and Fast (rabbit) position.
4. Turn the Key to the “START” position until the engine starts and then release it (**Figure 26**). The Key Switch will snap back to the “RUN” position and the engine will continue to run.
5. As the engine warms up, slowly adjust the Choke to the “Run” position (**Figure 25**). Wait until the engine runs smoothly before each Choke adjustment.
6. When the Engine is warmed up and running smoothly with the Choke in the “RUN” position, move the Throttle Control Lever to the fast (rabbit) position for chipping.

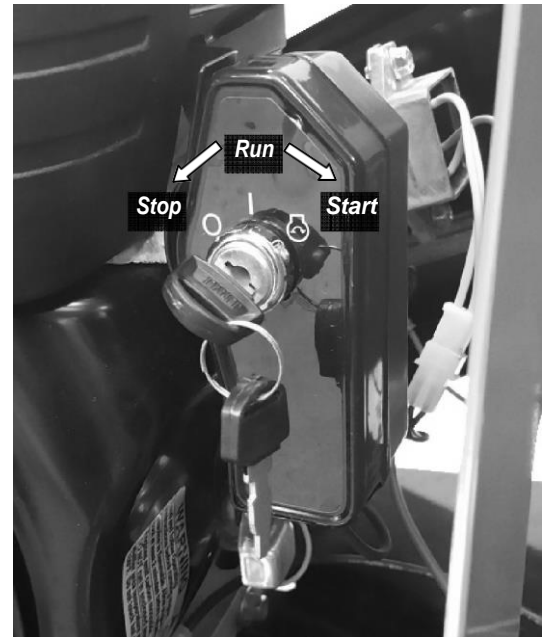

Figure 26

Stopping the Engine

WARNING

Shut down the Engine (The flywheel will continue to rotate for a while after the engine is shut off), Wait 5 minutes for the engine to cool and all moving parts to come to a complete stop, remove spark plug wire and disconnect the negative battery cable before moving or working on the chipper.

1. Slowly move the Throttle Control Lever all the way to the slow position (turtle icon).
2. For electric start models, turn the Key to the off position to stop the engine. Remove the Key for safety.

Note: Close the Fuel Shut-Off when transporting or storing the GRAVITY SELF-FEEDING WOOD CHIPPER.

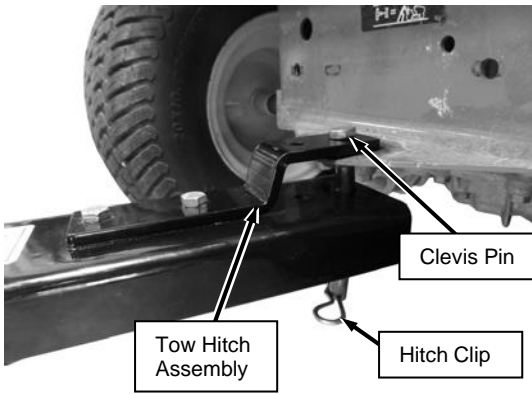

Figure 27

Connecting the Chipper to your Tractor

1. Lift the Chipper Tow Bar onto the Tractor Hitch and install the Hitch Pin and Hitch Clip to secure it (**Figure 27**).
2. Pull the Hitch Clip from the Pin and pull the Pin from the Support Leg and Tow Bar (**Figure 28**).
3. Rotate the Support Leg to the up (transport) position, align the holes in the Tow Bar and Leg, reinstall the Pin and secure with the Hitch Clip (**Figure 29**).

! DANGER

Avoid death or serious injury. Do not exceed 10 mph when towing the Yard-Tow model. Never tow the Standard model over roads.

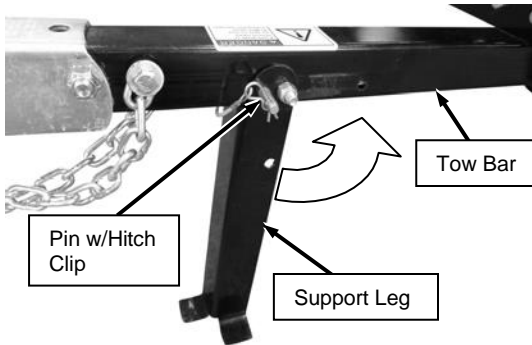

Figure 28

Connecting the Chipper to your Vehicle— Highway Kit

1. Pull the latch assembly on the Tow Hitch Assembly up and into the open position. Position the hitch coupler of the Chipper over and onto the tow vehicle's tow ball (must be a 2" tow ball) (**Figure 30**).
2. Pull the Hitch Clip from the Pin and pull the Pin from the Support Leg and Tow Bar (**Figure 28**).
3. Rotate the Support Leg to the up (transport) position, align the holes in the Tow Bar and Leg, reinstall the Pin and secure with the Hitch Clip (**Figure 29**).
4. Close the Latch Assembly on the Tow Hitch Assembly to lock it onto the Tow Ball (**Figure 31**). Attach the towing Safety Chains to the tow vehicle ensuring there is enough slack for turning.
5. Insert the Locking Pin into the hole in the Latch Assembly.

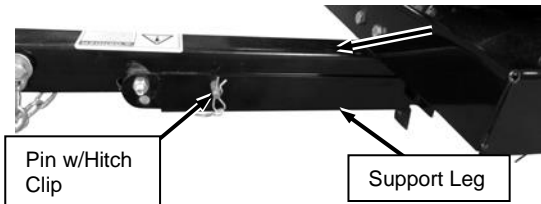

Figure 29

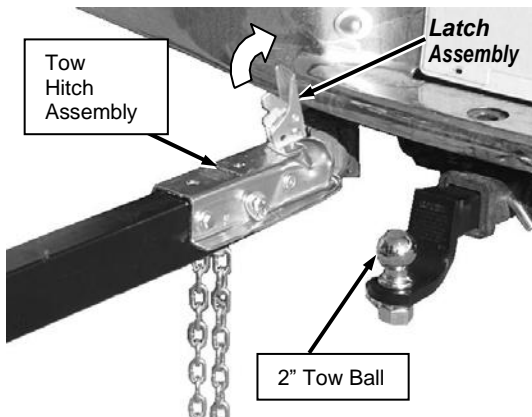

Figure 30

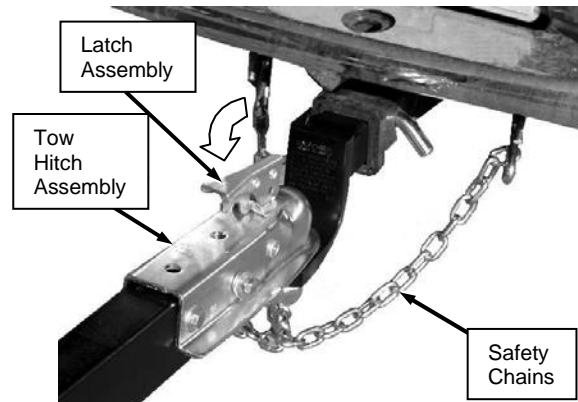

Figure 31

- Forextra safety and security, you may want to purchase a Lock or Lock Pin to install into the Latch Assembly of the Tow-Hitch Package (**Figure 32**).
- Connect the Wire Harness Connector to your Tow Vehicle and ensure that your lights on the Chipper are working properly.

⚠ DANGER

Avoid death or serious injury. Do not exceed 45 mph towing this machine.

⚠ WARNING

Making sure the chipper is securely attached to the vehicle is the responsibility of the owner/operator. Failure to securely attach the chipper can cause loss of control of the vehicle or the chipper being separated from the towing vehicle, resulting in serious injury or death.

Hitch Coupler Adjustment Check

- Place the proper size ball in the socket of the coupler and close the latch assembly (**Figure 33**). Verify that the locking trigger is properly engaged in its detent.
- Pull on the ball and/or coupler, trying to remove the ball from the socket. If the ball moves more than 1/16" in the coupler's socket, the clamp requires adjustment. Follow the proper adjustment procedure in the following steps.

Hitch Coupler Adjustment

- With the proper size ball in the socket of the hitch coupler, close the latch of the coupler completely (**Figure 34**). Verify that the locking trigger is properly engaged in its detent.
- Tighten the lock nut on the underside of the coupler until the spring between the nut and the clamp is fully compressed. Then back off the lock nut 1/2 turn or just enough that the latch is able to clamp and unclamp from the ball.

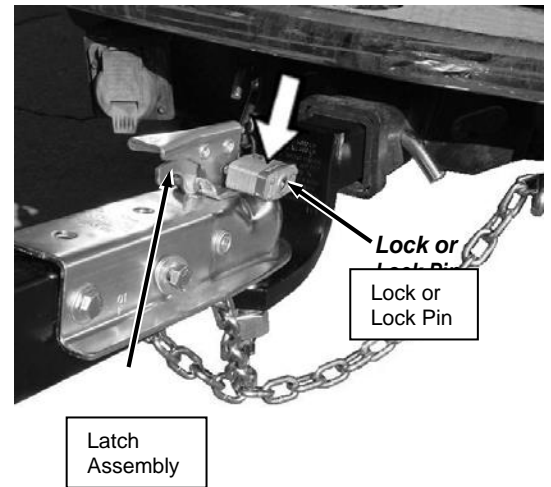

Figure 32

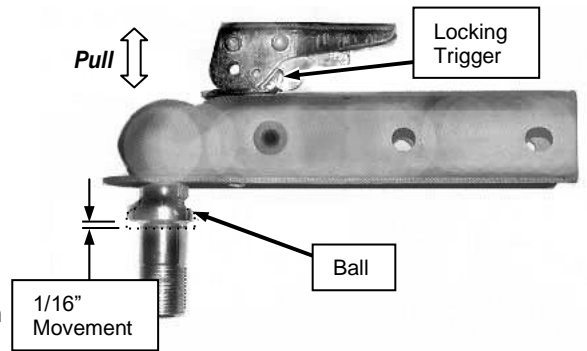

Figure 33

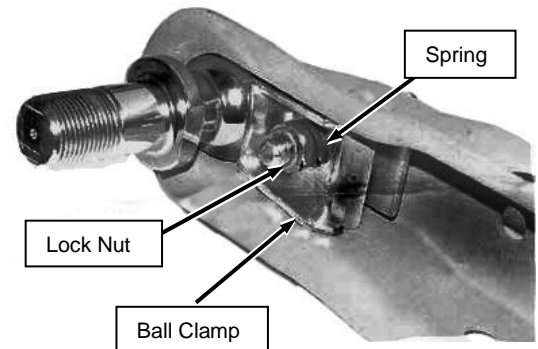

Figure 34



To Free a Jammed Flywheel

! WARNING

Shut down the Engine (The flywheel will continue to rotate for a while after the engine is shut off), Wait 5 minutes for the engine to cool and all moving parts to come to a complete stop, remove spark plug wire and disconnect the negative battery cable before moving or working on the chipper.

Tools Needed:

- Two 1/2" Wrenches
- 5/16 Wrench
- Phillips Head screwdriver

NOTICE

Never pry against the Scroll Weldment when removing the Deflector or Discharge Chute or at any other time. This will cause Damage to the machine.

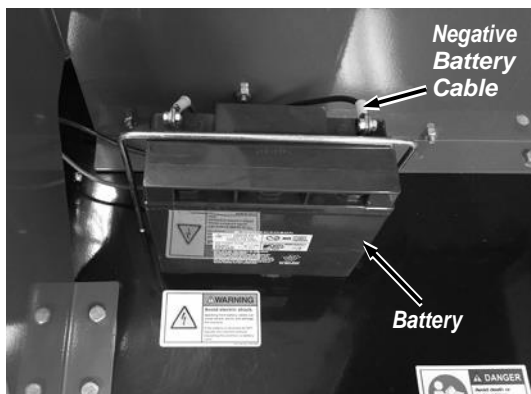

Figure 35

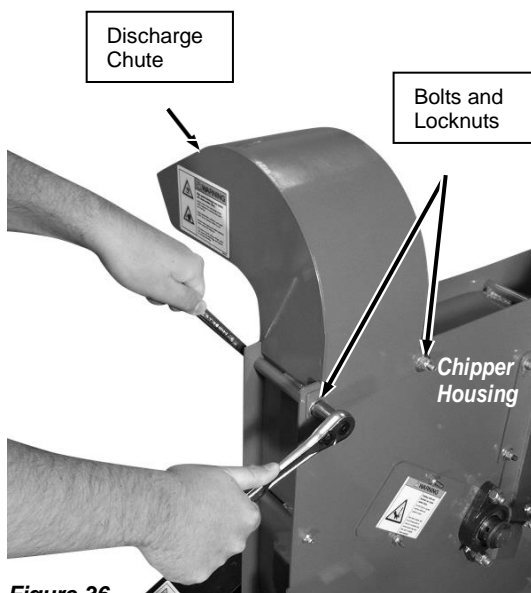

Figure 36

Disassemble:

1. Remove any material left in the Chipper Hopper.
2. Using a 5/16 Wrench and a Phillips Screwdriver, disconnect the negative terminal at the Battery (**Figure 35**).
3. Remove the two Bolts and Locknuts that secure the Discharge Chute to the Chipper Housing with two 1/2" Wrenches and then remove the Discharge Chute (**Figure 36**).
4. Check to see if the Discharge Chute or Discharge opening is clogged. If it is, clear it with a wooden stick.
5. With a wooden stick, loosen and remove any material left in the Chipper Housing and make sure the Flywheel turns freely with the stick.

Reassemble:

1. Position the Discharge Chute onto the Chipper Housing and secure with two Bolts and Locknuts using two 1/2" Wrenches.
2. Reconnect the battery negative terminal cable, the spark plug wire and start the Chipper engine; allowing the remaining material in the Chipper Housing to discharge.
3. If the Chipper Housing doesn't clear and the flywheel is still jammed, repeat above process.

Note: Be certain the Chipper Housing is clear before trying to process more material into the Chipper Hopper.

Chapter 4: Maintaining the GRAVITY SELF-FEEDING WOOD CHIPPER

This chapter covers regular maintenance procedures that will ensure the best performance and long life of your GRAVITY SELF-FEEDING CHIPPER. For engine maintenance, please refer to the Engine Owner's Manual that came with your machine. Service intervals listed in the checklist below supersede those listed in the Engine Owner's Manual.

WARNING

Shut down the Engine (The flywheel will continue to rotate for a while after the engine is shut off), Wait 5 minutes for the engine to cool and all moving parts to come to a complete stop, remove spark plug wire and disconnect the negative battery cable before moving or working on the chipper.

Regular Maintenance Check List

NOTE: Consider that the service intervals shown are the maximum under normal operating conditions. Increase frequencies under extremely dirty or dusty conditions.

Procedure	Before Each Use	Every 25 Hours	Every 40 Hours
Check Engine Oil Level	▲		
Check General Equipment Condition	▲		
Check that the Flywheel turns freely (with a long stick only)	▲		
Visually inspect Knife for damage and sharpness	▲		
Clean Engine Exterior and Cooling Fins	▲		
Check the Tire Pressure	▲		
Inspect or replace Air Filter and Foam Pre-cleaner	▲		
Check Knife and Wear Plate for Sharpness		▲	
Change Engine Oil	1 st time 5 hours	▲	
Check Belt Tension and Condition	1 st time 1 hour	▲	
Inspect or replace Drive Belt		▲	
Inspect or replace Spark Plug		▲	
Check/adjust Knife to Wear Plate Gap		▲	
Check the Battery Voltage (electric start only)		▲	
Check Knife and Wear Plate Attachment Screws			▲
Check Flywheel Bearing Collar Set Screws			▲
Lubricate Flywheel Bearings			▲

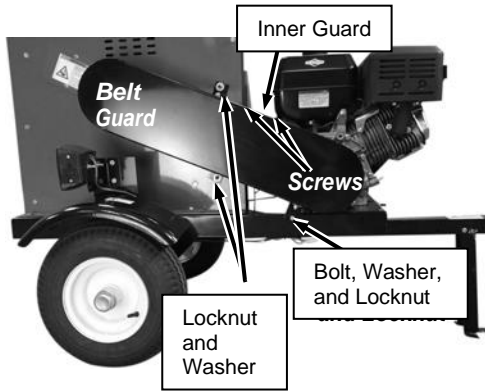

Figure 37

Grease Fittings

Your SELF-FEEDING CHIPPER was greased at the Factory. The operator needs to periodically lubricate the two Bearings of the Chipper Assembly.

Tools and Supplies needed:

- Two 1/2" Wrenches
- Flexible hose grease gun
- Lithium grease
- Clean cloth
- 1/8" Allen Wrench
- Loctite® 243

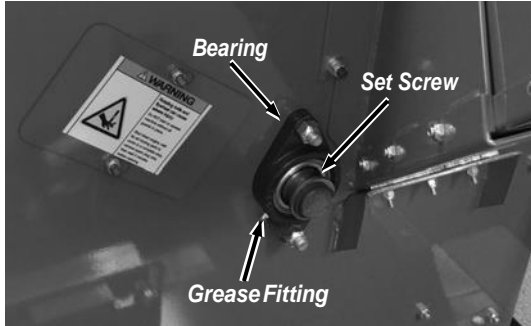

Figure 38

1. Remove the two Screws from the Inner Guard using a 5/16" Wrench or Flathead Screwdriver and remove the Inner Guard (**Figure 37**).
2. Remove the Bolt, Washer and Locknut that attaches the lower area of the Guard to the Frame using two 1/2" Wrenches.
3. Remove the two Locknuts and Washers at the center of the Guard using a 1/2" Wrench.
4. Remove the Guard.
5. Wipe all debris from the grease fitting on the Hopper side (**Figure 38**) and the Belt side (**Figure 39**) with a clean cloth.
6. Apply no more than three pumps of quality general-purpose lithium grease with a hand-pumped grease gun to each Bearing Grease Fitting.

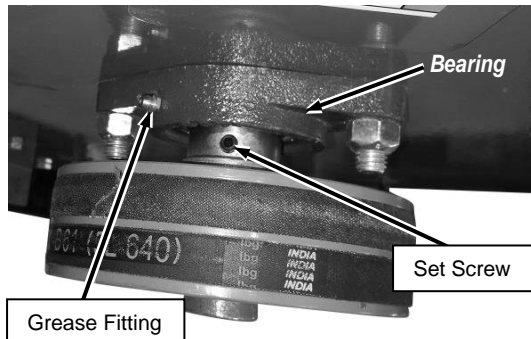

Figure 39

NOTICE

Over lubrication can damage the bearings.

7. Check the Set Screws for tightness. If they are not tight, remove them, apply Loctite® to the threads, then reinstall and tighten the Set Screws.
8. Replace the Belt Guard and Inner Guard when finished.

Removing and Replacing the Engine Oil

Tools and Supplies Needed

- SAE 30HDOil
- 12mm Wrench
- Suitable container for used oil
- Rags

Note: Drain the oil when the engine is warm. Warm oil drains quicker and more completely.

1. Position a suitable oil receptacle under the engine oil Drain Plug and remove the Engine Oil Check/Fill Cap (**Figure 40a or 40b**).
2. Remove the Oil Drain Plug from the Engine Block with a 12mm Wrench. Allow the used oil to drain completely, and then replace the Oil Drain Plug.
3. Replace the engine oil using SAE 30 HD oil (see “Adding Engine Oil and Gasoline” in Chapter 2 for instructions on adding oil).
4. Reattach the spark plug wire.
5. **Note:** Be sure to use environmentally safe procedures when disposing of the used oil.

Removing, Replacing and Adjusting the Drive Belt

NOTICE

Tested and proven for many hours of use.

Note: The WC475 Model has one Belt and the WC575E has two.

Tools Needed:

- Tape Measure
- 5/16" Wrench
- 1/8" Allen Wrench
- 7/16" Wrench
- 1/2" Wrench
- Two 9/16" Wrenches
- Straightedge

REMOVING THE BELT

1. Remove the two Self Tapping Screws using a 5/16" Wrench and remove the Inner Guard (**Figure 41**).
2. Remove the Bolt, Washer and Locknut that attaches the lower portion of the Guard to the Base using two 1/2" Wrenches (**Figure 41**).
3. Remove the two Locknuts and Washers at the center area of the Guard using a 1/2" Wrench.
4. Remove the Guard.
5. Loosen the four Engine Bolts (two on the left side and two on the right side) using two 9/16" Wrenches (**Figure 42**).
6. Loosen the Adjusting Bolt on the Belt Tensioner to create about a 1/2" gap, then slide the Engine away from you until the belt is loose enough to remove.

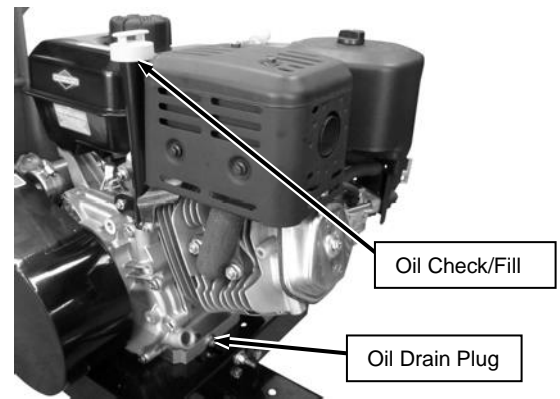

Figure 40a: WC475 Model

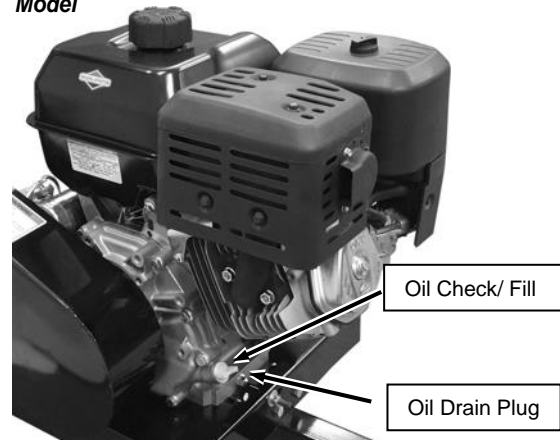

Figure 40b: WC575E Model

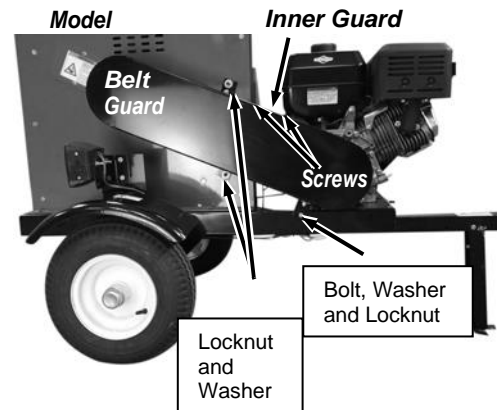

Figure 41

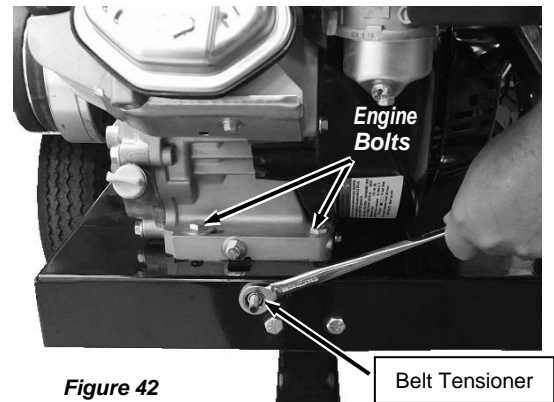

Figure 42

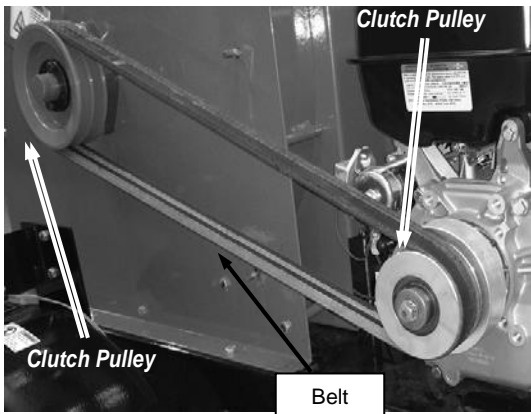

Figure 43

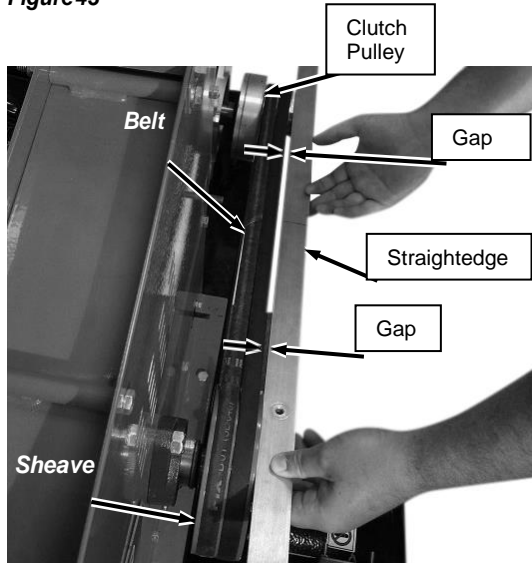

Figure 44

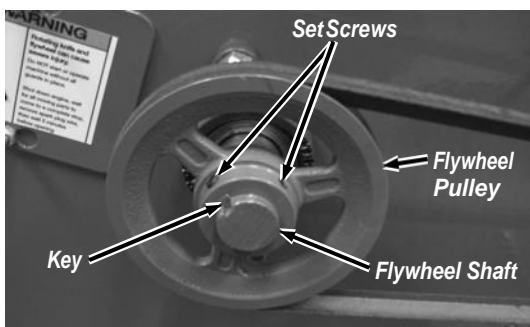
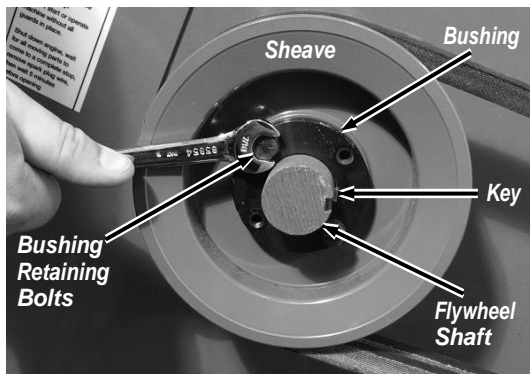

Figure 45a: WC475 Model



7. Remove the Belt from the Clutch and Sheave (**Figure 44**).

INSTALLING AND ADJUSTING THE BELT

Note: The Belt Tensioning Adjusting Bolt may need to be loosened up more per the previous instructions "Removing the Belt" to enable you to install a new Belt.

1. Install the new Belt onto the Sheave and Clutch.
2. Use a 1/2" Wrench to adjust the Belt Tensioner until the Belt is not sagging but not too tight (**Figure 43**).
3. Check the alignment of the Clutch with the Sheave by placing a Straightedge flat across the Sheave outer surface and position the other end of the above (not touching) the face of the Clutch Pulley (**Figure 44**).
4. Check the gap from the Straightedge to the Belt near the Sheave and near the Clutch. If the gap is the same then no adjustment is needed. If the gap is not the same then adjustment is necessary, correct the alignment as follows:

WC475 MODEL

- a) Loosen the Flywheel Pulley Set Screws a few turns using a 1/8" Allen Wrench (**Figure 45a**).
- b) Move the Flywheel Pulley in or out to align the Belt with the Straightedge.

Note: Make sure the Key stays in the Key slot of the Pulley.

- c) Tighten the Set screws to secure the Pulley.

WC575E MODEL

- a) Remove the Bushing Retaining Bolts with a 7/16" Wrench (**Figure 45b**).

Note: The Sheave Bushing has four holes. Two holes for securing the Sheave to the Bushing (threads are in the Sheave) and two holes for separating the Sheave from the Bushing (threads are in the Bushing).

- b) Reinstall the two Bolts into the Bushing Threaded Holes next to the two holes you just removed the Bolts from.
- c) Slowly tighten the Bolts evenly and alternately (1/4 to 1/2 turn) starting with the Bolt farthest from the Bushing Saw Slot (this acts as a Hub puller) until the Bushing releases from the Flywheel Shaft.
- d) When the Sheave is loose, remove the two Bolts and reinsert them into the original Retaining Bolt holes by hand.
- e) Using the Straightedge, align the Clutch and Sheave by moving the Sheave Bushing in or out on the Flywheel Shaft.

Note: The Pulley will move slightly onto the Bushing when tightening the Bolts. You may need to compensate for this movement when positioning the Bushing on the Shaft.

- f) Slowly tighten the Bushing Retaining Bolts evenly and alternately (1/4 to 1/2 turn). The Bolts only need to be snug. Do not over tighten.
- g) Recheck the alignment and adjust as needed.

Figure 45b: WC575E Model

5. Place a Straightedge along the Belt (over the Clutch and Sheave) and push down firmly on the Belt to measure the deflection from the Straightedge to the Belt with a tape measure (**Figure 46**).
6. The measurement should be approximately 3/8" with approximately 10 pounds of force applied to it.
7. If the measurement is not correct, loosen the Engine Bolts and tighten or loosen the Adjusting Nut as needed (**Figure 42**).
8. Repeat steps 5 through 7 until the proper Belt tension is achieved.
9. When the Belt is properly tensioned, ensure that the four Engine Bolts are completely tightened.
10. Reinstall the Belt Guard and Inner Guard.

Note: Check and re-tighten the Drive Belt, if necessary, after an initial break-in period of one hour.

VISUAL Inspection of the Chipper Knife (Before every use) and Wear Plate (minimum every 25 hours)

NOTICE

Routinely check the wear plate for a sharp square edge. Using a rounded or chipped wear plate will decrease performance and cause excessive vibration that will cause damage to the GRAVITY SELF-FEEDING WOOD CHIPPER and make chipping difficult for the operator.

NOTICE

Routinely check the chipper knife for sharpness. Using a dull knife will decrease performance and cause excessive vibration that will cause damage to the GRAVITY SELF-FEEDING WOOD CHIPPER.

Tools Needed:

- One 1/2" Wrench and one Phillips Head Screwdriver

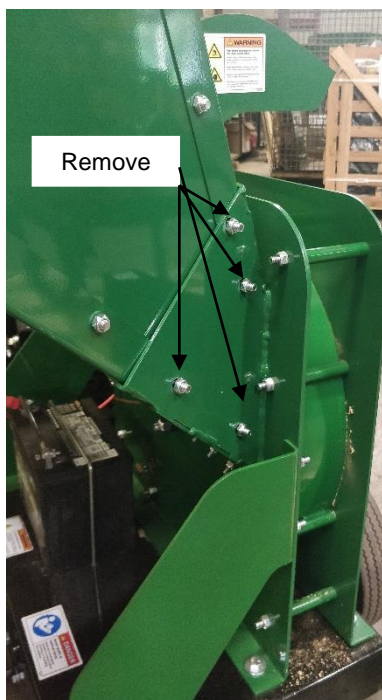

Figure 48

Remove the Hopper hardware as described below.

1. Remove the lowest four 5/16-18 x 3/4" Truss Head Bolts and thin Nylon Locknuts that attach the Hopper Assembly onto the Hopper Neck from each side of the Hopper Assembly (**Figure 48**).
2. Make sure that the unbolted Hopper Assembly will rest inside of the Hopper Neck before removing the final bolt.
3. Slide the Hopper Assembly out of the Hopper Neck.
4. Use a stick to rotate the Flywheel until the Knife is next to the Wear Plate.

! WARNING

Be careful and wear gloves when working near the chipper knife. The knife edge can cut you if you come in contact with it.

5. Closely inspect the Chipper Knife and Wear Plate for nicks or dull (rounded) edges (**Figure 49**).
6. If necessary, repair or replace the Chipper Knife and/or Wear Plate (see those sections in this chapter).
7. Check the Chipper Knife to Wear Plate gap (see that section in this chapter).

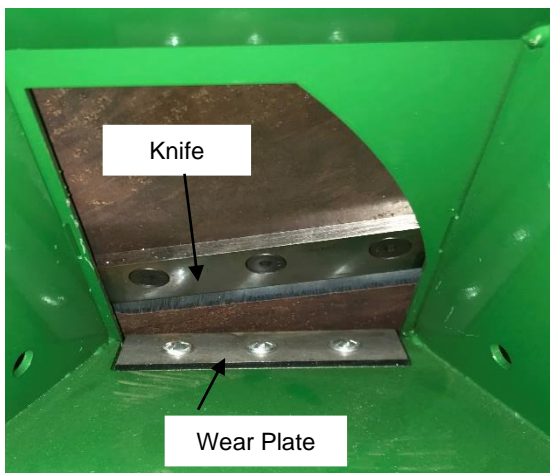

Figure 49

Removing and Replacing the Chipper Knife

Tools Needed:

- 7/16" Wrench
- 1/2" Socket with extension
- 3/16" Allen wrench
- Awl or Sharp Tool
- Gloves

1. Loosen the Locknuts that secure the rear Access Cover with a 7/16" Wrench (**Figure 50**). Move the Cover over to align the larger portion of the hole with the Locknuts and remove the Cover.
2. Rotate the Flywheel using a stick until the three countersunk Allen Screws (**Figure 51**) and Locknuts (**Figure 52**) attaching the Knife to the Flywheel are visible through the Access Openings.
3. Clean out the heads of the Allen Screws with an Awl or Sharp Tool (**Figure 51**).
4. Insert a 3/16" Allen Wrench into the head of a screw.
5. While holding the Allen Wrench, remove the Locknut using a 1/2" socket (**Figure 52**).
6. Repeat Steps 5 and 6 for the remaining two Allen Screws.
7. Remove the dull or damaged Knife and visually inspect the Flywheel Slot and Knife mounting area and be sure they are clean and that the replacement Knife will be able to mount flush against the Flywheel.

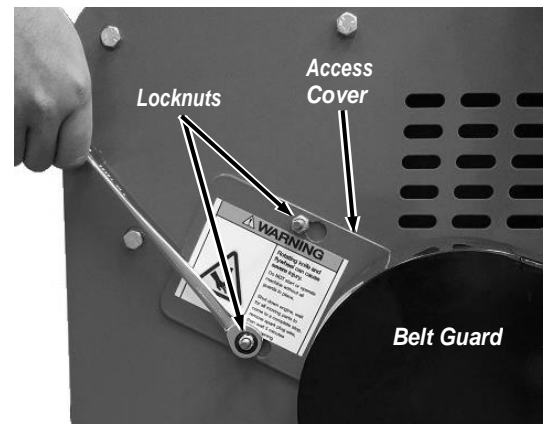

Figure50



Figure51

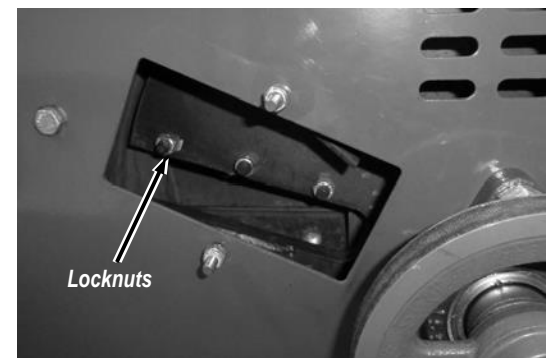

Figure52



Figure53

CAUTION

If the flywheel surface is not cleaned properly and the chipper knife is not mounted flush on the flywheel, the knife could crack when the hardware is tightened.

8. Install a new or sharpened Knife as shown with the Knife edge facing down and towards you (**Figure 51**) and finger tighten the Allen screws and Lock Nuts (use the new hardware supplied with a new Knife kit) to hold the Knife to the Flywheel.
9. Using a 3/16" Allen wrench and a 1/2" socket with extension, tighten the center Screw and Locknut, then tighten the outer Screw and Locknut, and finally tighten the inner Screw and Locknut.
10. Double-check that all three Locknuts on the Allen Screws are tight.
11. Check and if needed adjust the gap between the Knife and Wear Plate (See "Checking and Adjusting the Knife to Wear Plate Gap" in this Chapter).

Removing and Replacing the Wear Plate

Tools Needed:

- 7/16" Wrench

1. Remove the three Locknuts and Carriage Bolts that attach the Wear Plate to the Chipper Assembly with a 7/16" Wrench and then remove the Wear Plate (**Figure 53**).
2. Install the new Wear Plate and secure with the three Carriage Bolts and Locknuts.
3. Check the Chipper Knife to Wear Plate gap (see that section in this chapter).

Checking and Adjusting the Knife to Wear Plate Gap

When you replace the Knife or Wear Plate you must check and set the clearance between the Knife and Wear Plate. Set this clearance or gap to 1/16" by using the Gap Tool that is supplied with the Chipper and with a new Knife kit. If the gap between the Wear Plate and the Knife is not set correctly, you will have excessive vibration when chipping and the Knife will seem to be dull.

The Wear Plate should have a square edge and be free of dents or gouges. The Wear Plate can be hand sharpened (see steps in this Chapter).

NOTICE

Be careful not to overheat the Wear Plate during the sharpening process. This will change the characteristics of the steel and could cause damage to the machine. Replace the Wear Plate if it has been overheated.



Figure 54

Tools Needed:

- 7/16" Wrench
- Gap Gauge (provided with Chipper and with new Knife Kits)

1. Remove the Hopper (See "Inspecting the Chipper Knife and Wear Plate" in this Chapter).
2. Use a stick to rotate the Flywheel until the Knife can be positioned next to the Wear Plate.
3. Slide the Knife Gauge in between the Knife and Wear Plate to check the clearance (**Figure 54**).

- If the Knife Gauge slides freely, with no resistance and extra space, the Wear plate must be adjusted.

- If the Knife Gauge will not slide down between the Knife and Wear Plate, the Wear Plate must be adjusted.

- If the Knife Gauge slides in between the Knife and Wear Plate with some resistance felt against them both then the Wear plate is properly adjusted.

4. To adjust the Wear Plate Gap, loosen the three Nuts on the Carriage Bolts with a 7/16" Wrench just enough so the Wear Plate will move but still have a slight resistance. Now you can slide the Wear Plate up or down (in or out) to achieve the correct gap setting (**Figure 54**).

Note: See **Figure 55** for a more detailed look at the relationship of the Knife to Wear Plate.

5. Take the Gap Gauge and slide it between the Knife and Wear Plate. Adjust the Wear Plate against the Knife Gauge and tighten the Locknuts.
6. Check the adjustment using the Gap Gauge.
7. Install the Hopper and Access Cover when finished.
8. Re-connect the negative battery terminal wire (electric start only) and the spark plug wire.

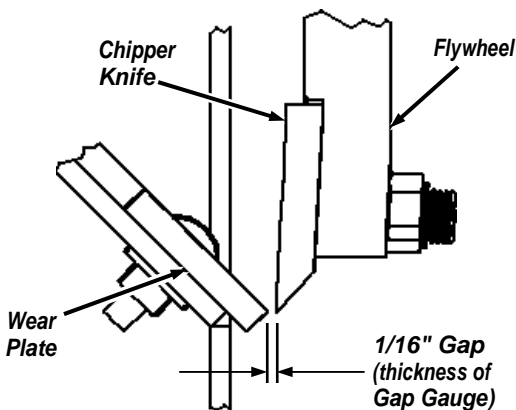

Figure 55

NOTICE

After any Knife or Wear Plate maintenance or adjustment, rotate the Chipper flywheel by using a wooden stick and watch and listen carefully for any unusual noises, clicking or vibration. If you detect any of these, inspect the machine for damage, or any loose parts. Repair or replace any damaged parts and tighten any loose parts before starting the GRAVITY SELF-FEEDING WOOD CHIPPER.

Chipper Knife Sharpening

- You should never attempt to sharpen the Chipper Knife freehand.
- It is extremely important to consistently maintain the 45-degree angle for proper performance (**Figure 56**).
- Excessive heat generated during the sharpening process will damage Knives and weaken the metal. Be sure not to overheat the Knife during sharpening because it will shorten the life of the Knife.
- Take the Chipper Knife to a machine shop for proper sharpening.
- How many times a Knife can be sharpened is determined by how much material needs to be taken off to sharpen or to compensate for dents or gouges.
- A new Chipper Knife has .970" measurement between the short side bevel edge and the Knife Top Edge (**Figure 57 "New Knife"**).
- The knife should never be sharpened to the extent that more than 3/32" is taken off this measurement.
- Once this measurement is below .876" (**Figure 57 "Sharpened Knife"**), or if you are unable to remove dents or gouges with these guidelines, replace the Knife.

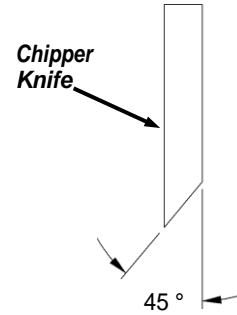

Figure 56

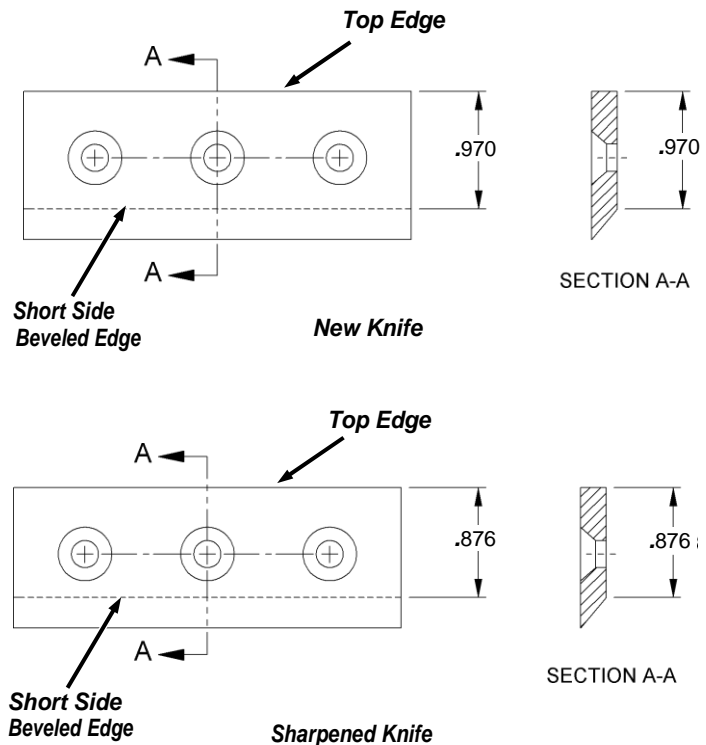

Figure 57

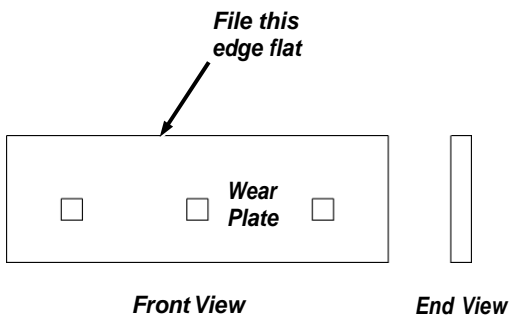

Figure 58

Wear Plate Sharpening

The Wear Plate edges become rounded and chipped during use and must be squared off to ensure efficient operation.

Tools Needed:

- Flat File

1. Secure the Wear Plate in a vise.
2. File the edge of the Wear Plate to take out any nicks and to square rounded edges (**Figure 58**).

NOTE: If the Wear Plate is filed enough times that the proper gap between the Knife and Wear Plate cannot be set with the Gap Gauge, you will need to replace the Wear Plate.

Removing and Replacing the Wheels

The Wheels on the GRAVITY SELF-FEEDING WOOD CHIPPER are pneumatic. The Standard model has pressed in bearings for easy transport. The Highway Kit Accessory has tapered bearings designed for highway use. With use, tires or bearings may need replacing. The following procedures will explain the replacement procedures.

STANDARD MODEL

Tools Needed:

- 5/32" Allen wrench
- Fine Tooth File
- Jack

1. Jack up the side of the Chipper just until the Pneumatic Wheel is off the ground.

2. Loosen the Set Screw with a 5/32" Allen wrench and remove the Locking Collar (**Figure 59**).

3. Remove the Pneumatic Wheel from the Axle.

Note: File off the Set Screw marks in the Axle if Wheel will not slide on.

4. Install the Pneumatic Wheel onto the Axle and against the Spacer with the Valve side out.

5. Install the Locking Collar onto the Axle against the Wheel and tighten the Set Screw with a 5/32" Allen Wrench.

6. Check the Pneumatic Wheels for proper air pressure (see Chapter 3).

HIGHWAY ACCESSORY

Tools Needed:

- Needle Nose Pliers
- Flat Tip Screwdriver
- Hammer
- Block of Wood
- Jack

1. Jack the chipper up and place it on Jack Stands so the wheel is off the ground.

2. Using a Flat tip Screwdriver, pry the dust cap off of the hub.

3. Using pliers remove the Cotter Pin and back the Castle nut off (**Figure 60**).

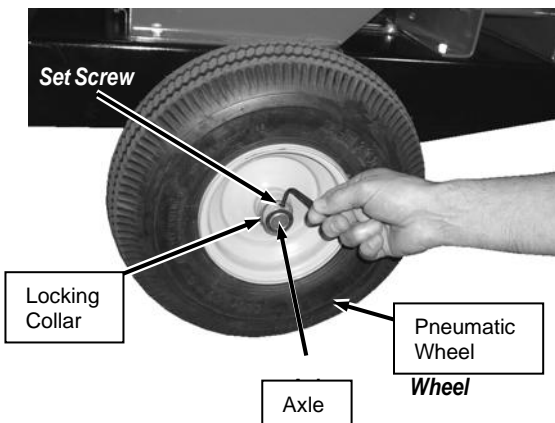

Figure 59

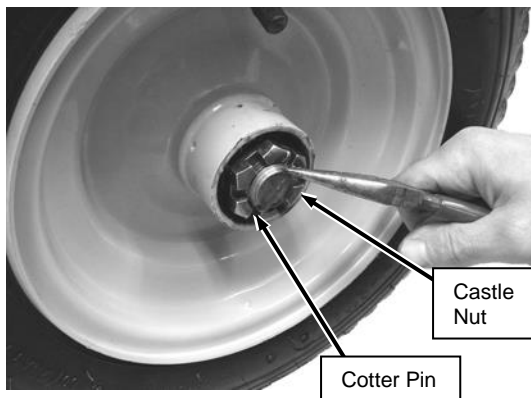

Figure 60

4. Remove the Tire and replace it with a new wheel assembly.
5. Screw the Castle Nut onto the Axle and tighten it with an adjustable wrench to seat the Bearings (**Figure 61**).
6. Back the Castle Nut off and then snug it up to the Bearing lightly.
7. Insert a Cotter Pin through the slots of the Castle Nut and into the hole in the Axle.
8. Bend the ends of the Cotter Pin with Needle nose Pliers to secure it.
9. Place the Dust Cap onto the Wheel Assembly and secure it by placing a piece of wood over it and pounding lightly with a hammer until it is against the lip (**Figure 62**).
10. Jack the back of the Chipper up and remove the jack Stands.
11. Lower the Chipper to the ground.
12. Check the Tire for proper air pressure of 60 psi maximum in each tire.

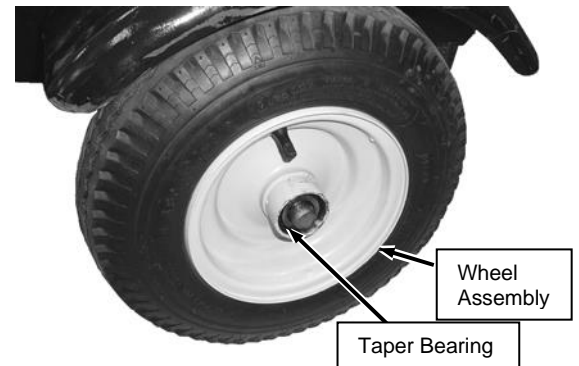

Figure 61

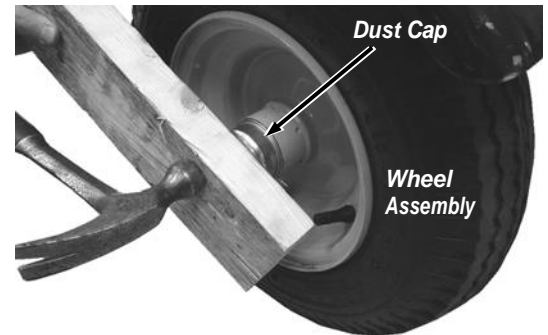

Figure 62

Removing and Replacing the Clutch

The design of the Clutch on your machine is for rugged, dependable service; however, it is important to understand the limitations of a Clutch. The Clutch provides load free starting of the Engine and provides slippage under excessive overloading of the driven application. These features help protect the Engine from damages such as broken crankshafts and starters. The Shoes and Springs on the Clutch are normal wear items. If you notice decreased performance of the Clutch, check and replace it if necessary.

The Clutch obtains its power from the Engine RPM. The lower the engagement speed, and the higher the maintained Engine speed, the more torque the Clutch can transfer to the driven unit. NEVER operate the GRAVITY SELF-FEEDING WOOD CHIPPER Engine at less than full RPM when chipping.

Note: At engine start-up, the engine of your chipper operates under no load until approximately 1800 RPM, at which speed the centrifugal clutch engages and begins driving the rotor.

NOTICE

- Do not tamper with the engine's governor setting. The governor controls the maximum safe operation speed and protects the engine. Over-speeding the engine is dangerous and will cause damage to the engine and to the other moving parts of the machine. See your authorized dealer for any engine governor adjustments.
- Become familiar with successful operating conditions and avoid those that can overload and damage the machine.
- Do not overload or attempt to chip material beyond manufacturers recommendation. Personal injury or damage to the machine could result. Learn to recognize the sound of the machine during an overload condition. Only your operator experience will tell you how fast you can successfully feed material into the machine.
- If overloading or any other cause jams the machine, stop the machine immediately. If you jam the machine and do not stop the engine, it can burn the drive belt and/or ruin the clutch. Clutch damage can be costly and it may not be covered under warranty. For this reason, it is important that you immediately shut off the machine if it becomes jammed.
- The centrifugal clutch on this machine is permanently lubricated and does not require oil or grease. If, after long periods of use, the drum wobbles excessively, replace the clutch assembly. Always replace shoes and springs in sets. Whenever shoes are changed, replace all springs.

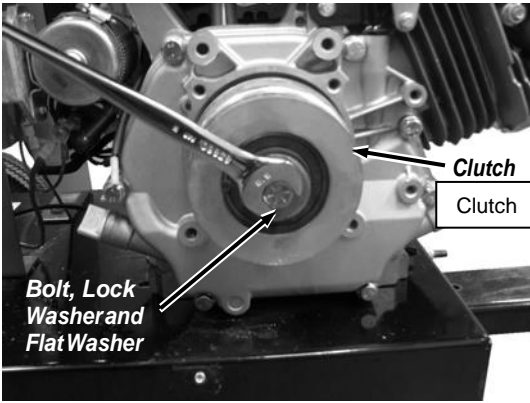

Figure 63

Installing a new Clutch Assembly

Note: If a Clutch part malfunctions, it could jeopardize the integrity of other Clutch components. If you have problems with the Clutch, a Clutch Kit is available, but we recommend replacing your Clutch as a complete assembly.

Tools and Supplies Needed:

- 5/8" Wrench or Air Wrench and Socket
- Anti-seize compound

1. Remove the Belt Guard and Belt (see "Removing and Replacing the Drive Belt" in this Chapter).

Note: You may need to use an Air Wrench to break the Clutch Bolt loose depending how tight it is on the Engine shaft.

2. With a 5/8" Wrench, remove the Clutch Bolt, Lock Washer and Washer and then slide the Clutch from the Crankshaft (**Figure 63**).

3. Remove the Key from the keyway in the Engine Crankshaft and set it aside.
4. Clean the engine crankshaft and remove any burrs, then apply Anti-seize compound to the Crankshaft.
5. Install the Key in the keyway of the new Clutch hub, align the Key with the slot in the Engine Crankshaft, and slide the new Clutch Assembly onto the shaft.
6. Secure the Clutch with the Washer, Lock Washer and Clutch Bolt using a 5/8" Wrench.
7. Reinstall the Drive Belt and set the Drive Belt tension and alignment (see "Removing and Replacing the Drive Belt" in this Chapter).
8. Reinstall the Belt Guard (see "Removing and Replacing the Drive Belt" in this Chapter).

Battery Care (electric start only)

Proper care can extend the life of a battery. Follow these recommendations to ensure your battery's best performance and long life:

- Do not allow the battery charge to get too low. If the machine is not used, charge the battery every 4 – 6 weeks. Operate the engine for at least 45 minutes to maintain proper battery charge.
- Store an unused battery in a dry area that does not freeze.
- Do not charge an already charged battery. In theory, you cannot overcharge our battery with a trickle charger; however, when a battery is fully charged and the charger is still on, it generates heat that could be harmful to the battery. A fully charged battery will read 12V-13.2V with a voltmeter.
- Do not continue to crank your engine when the battery charge is low.

Charging the Battery

Operate the engine for at least 45 minutes to maintain proper battery charge. If the battery loses its charge, you will need to use a trickle charger to recharge it. The charger should have an output of 12 volts DC at no more than 2 amps.

- At 1 amp, the battery may need to be charged for as long as 48 hours.
- At 2 amps, the battery may need to be charged for as long as 24 hours.

To connect a battery charger to your GRAVITY SELF-FEEDING WOOD CHIPPER, follow the steps listed below.

1. Attach the black (-) battery charger wire to the battery negative (-) terminal, and attach the red (+) battery charger wire to the battery positive (+) terminal.
2. Plug the battery charger into an outlet.

NOTICE

When you are finished charging the battery, disconnect the charger from the outlet First, then disconnect the battery charger wires from the battery. If you leave the battery charger wires connected to the battery, the battery will discharge itself back into the charger.

Recycling a Used Battery

Please dispose of your used batteries responsibly by recycling them. Call your local Solid Waste Management District or your local waste handler to locate the collection site nearest you. Some collection sites recycle batteries year-round; others collect them periodically.

You can also visit the Website of Earth 911 for more information (www.earth911.org). Once there, click the Municipal HHW link under Hazardous Household Waste, and enter your zip code. The site lists recycling centers located near you.

For a fee, you can recycle your batteries with the International Metals Reclamation Company. Visit them at www.inmetco.com and click Services, then click Battery Recycling; or contact them at:

INMETCO

PO Box 720

245 Portersville Road

Ellwood City, PA 16117

(724) 758-2800; fax (724) 758-2845

To learn more about hazardous waste recycling, visit the Website for Battery Council International (www.batterycouncil.org) or for the Environmental Protection Agency (www.epa.gov).

NOTICE

Please dispose of used batteries responsibly, according to your local hazardous Materials regulations. Never throw away used batteries in your household trash.

Chapter 5: Troubleshooting

Most problems are easy to fix. Consult the Troubleshooting Table below for common problems and their solutions. If you continue to experience problems, contact us at www.MacKissic.com or call **(800)348-1117** for support.

WARNING

Shut down the Engine (The flywheel will continue to rotate for a while after the engine is shut off), Wait 5 minutes for the engine to cool and all moving parts to come to a complete stop, remove spark plug wire and disconnect the negative battery cable before moving or working on the chipper.

Troubleshooting Table

SYMPTOM	POSSIBLE CAUSE
<p><i>The engine won't start using electric-start.</i></p> <p><i>(Please refer to the Engine Owner's manual for engine-specific procedures.)</i></p>	<ul style="list-style-type: none"> ⇒ Is the Fuel Shut-Off Valve in the ON position? ⇒ Is the spark plug wire attached? ⇒ Have you checked all the items under the section called Electric Starting in Chapter 3? ⇒ Check the wire connections, especially the large black ground wire where it connects to the battery and where it connects to the engine. ⇒ Is your battery charged? Check the voltage yourself or at a service station. If it's low, charge it with a 12-volt, 1 to 2 Amp trickle charger. If you don't use your Chipper for at least 45 minutes at a time, the battery may need to be periodically charged. See the Battery Care section in Chapter 4. ⇒ If your battery is charged and your GRAVITY SELF-FEEDING WOOD CHIPPER still won't start, contact us at www.MacKissic.com or call (800)348-1117 for assistance.
<p><i>The engine lacks power or is not running smoothly.</i></p> <p><i>(Please refer to the Engine Owner's Manual for engine-specific procedures.)</i></p>	<ul style="list-style-type: none"> ⇒ Check the Throttle Lever travel and adjustment. Is the Throttle Lever in the Run position? ⇒ Is the Choke lever pushed all the way over to the RUN position? See Chapter 3. ⇒ Is the air filter clean? If it's dirty, change it following the procedure in the Engine Owner's Manual. ⇒ Is the spark plug clean? If it is fouled or cracked, change it. If it is oily, leave it out, hold a rag over the spark plug hole and engage the electric starter for a few seconds to blow out any oil in the cylinder, then wipe off the spark plug and reinsert it. ⇒ Are you using fresh, clean unleaded gas? If it's old, change it. Use a fuel stabilizer if you keep gas longer than two weeks or so. ⇒ Does your engine have the right amount of clean oil? If it's dirty, change it following the procedure in Chapter 4. ⇒ If your engine still lacks power, contact us at www.MacKissic.com or call (800)348-1117 for assistance.
<p><i>The machine's wheels track left or right while being towed.</i></p>	<ul style="list-style-type: none"> ⇒ Check the tire pressure. There should be 38 psi in each tire. There should be 60 psi in each tire if you have the Highway Accessory.
<p><i>Engine smokes.</i></p>	<ul style="list-style-type: none"> ⇒ Check the oil level and adjust as needed. ⇒ You may be operating the machine on too great an incline. The machine should be level. ⇒ Check the air filter and clean or replace if needed. ⇒ You may be using the wrong oil - too light for the temperature. Refer to your Engine Owner's Manual for detailed information. ⇒ Clean the engine cooling fins and the carburetor housing if they're dirty. ⇒ If the engine still smokes, contact us at www.MacKissic.com or call (800)348-1117 for assistance.

Troubleshooting Table (continued)

WARNING

Shut down the Engine (The flywheel will continue to rotate for a while after the engine is shut off), Wait 5 minutes for the engine to cool and all moving parts to come to a complete stop, remove spark plug wire and disconnect the negative battery cable before moving or working on the chipper.

SYMPTOM	POSSIBLE CAUSE
<i>Chipping action seems too slow or flywheel stalls.</i>	<ul style="list-style-type: none"> ⇒ The engine speed is too slow causing the belt to slip. Run the engine at full throttle. ⇒ Check for loose or damaged Drive Belt; tighten or replace. See Chapter 4. ⇒ Check for a dull or damaged Knife; sharpen or replace the Knife. See Chapter 4.
<i>The belt frays or rolls over the pulley.</i>	<ul style="list-style-type: none"> ⇒ The rotor Drive Pulley groove may be nicked. Check the Drive Belt for wear and hard spots. File off any nicks on the pulley. ⇒ The Drive Belt may be stretched; replace it. See Chapter 4. ⇒ The Pulleys may be misaligned. See Chapter 4.
<ul style="list-style-type: none"> - Clutch overheats. - Belt burns. - Flywheel won't turn. 	<ul style="list-style-type: none"> ⇒ Immediately stop the engine and disconnect the spark plug wire. ⇒ Turn the Flywheel with a wooden stick to be sure it turns freely. ⇒ Check for a loose Drive Belt. See Chapter 4. ⇒ Remove any built-up debris from the Chipper Hopper Inlet and Discharge Chute.
<i>The machine has excessive vibration.</i>	<ul style="list-style-type: none"> ⇒ Check for a dull or damaged Knife; sharpen or replace the Knife. See Chapter 4. ⇒ Check the Knife to Wear Plate Gap. See Chapter 4. ⇒ The Knife is not properly seated on the flywheel. Loosen the Knife mounting screws, reset the Knife and tighten the screws. ⇒ If the machine still exhibits excessive vibration, contact us at www.MacKissic.com or call (800)348-1117 for assistance.
<i>When chipping, the log seems to vibrate excessively and "hammers" my hands.</i>	<ul style="list-style-type: none"> ⇒ The Knife is dull; sharpen or replace it. See Chapter 4. ⇒ The gap between the Knife and Wear Plate is too great; adjust the Gap. See Chapter 4. ⇒ Check Engine rpms; run Engine at full throttle when chipping.
<i>Material does not feed as well.</i>	<ul style="list-style-type: none"> ⇒ The Knife is dull; sharpen or replace it. See Chapter 4. ⇒ Check Engine rpms; run Engine at full throttle when chipping.
<i>Chipper Knife is hitting the Wear Plate.</i>	<ul style="list-style-type: none"> ⇒ The gap between the Knife and the Wear Plate is set incorrectly; adjust the Knife to Wear Plate Gap. See Chapter 4.
<i>Engine runs but the flywheel doesn't rotate.</i>	<ul style="list-style-type: none"> ⇒ The inner Shoes of the Clutch are worn. Replace worn or broken Clutch parts. See Chapter 5. ⇒ Loose Drive Belt; adjust the Drive Belt tension. See Chapter 4. ⇒ Remove any built-up debris from the Chipper Hopper Inlet and Discharge Chute.

Common Engine Answers

WARNING

Shut down the Engine (The flywheel will continue to rotate for a while after the engine is shut off), Wait 5 minutes for the engine to cool and all moving parts to come to a complete stop, remove spark plug wire and disconnect the negative battery cable before moving or working on the chipper.

Oil Recommendations:

To optimize engine performance, use Warranty Certified Briggs & Stratton Small Engine Oil. Briggs & Stratton offers a Synthetic 5W30 oil that provides the best protection at all temperatures as well as improved starting with less oil consumption. For optimum performance, you should change the oil in your small engine after the first five hours of use and then annually, or every 50 hours of use (whichever comes first).

- Use Briggs & Stratton SAE 30W Oil above 40°F for all of our engines.
- Check oil level regularly.
- Air-cooled engines burn about an ounce of oil per cylinder, per hour.
- Fill to mark on dipstick. DO NOT OVERFILL.

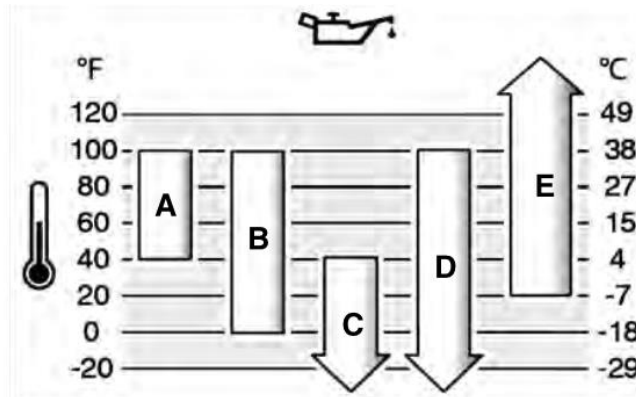

A	SAE 30 - Below 40 °F (4 °C) the use of SAE 30 will result in hard starting.
B	10W-30 - Above 80 °F (27 °C) the use of 10W-30 may cause increased oil consumption. Check oil level more frequently.
C	5W-30
D	Synthetic 5W-30
E	Vanguard® Synthetic 15W-50

Oil Fill Capacity:

	WC475 & WC475E	WC575EE
Engine Model	XR1650 Series	XR2100 Series
Engine Part Number	25N132-0012(WC475) or 25N137-0013(WC475E)	25T237-0085
Oil Fill Capacity	37 oz	37oz

Please refer to the Engine Owner's Manual provided for oil draining and filling instructions.

Fuel Recommendations:

Fuel must meet these requirements:

- Clean, fresh, unleaded gasoline.
- A minimum of 87 octane/87 AKI (91 RON). High altitude use, see below.
- Gasoline with up to 10% ethanol (gasohol) is acceptable

NOTICE: Do not use unapproved gasolines, such as E15 and E85. **Do not mix oil in gasoline** or modify the engine to run on alternate fuels. Use of unapproved fuels will damage the engine components, which will not be covered under warranty.

! WARNING

Shut down the Engine (The flywheel will continue to rotate for a while after the engine is shut off), Wait 5 minutes for the engine to cool and all moving parts to come to a complete stop, remove spark plug wire and disconnect the negative battery cable before moving or working on the chipper.

Spark Plug Information:

	WC475 & WC475E	WC575EE
Engine Model	XR1650 Series	XR2100 Series
Spark Plug Part Number (B&S)	798615	798615
Spark Plug Gap	0.030 in (0.76 mm)	0.030 in (0.76 mm)
Spark Plug Torque	275 lb-in (31 Nm)	275 lb-in (31 Nm)

Please refer to the Engine Owner's Manual provided for regular Maintenance Schedule.

For any other engine questions or problems please visit the Briggs & Stratton website, www.briggsandstratton.com, to locate a dealer near you.

- "Locate a Dealer" is found under the Support drop down and within the Product Support column.

Chapter 6: Chipper Accessories

WARNING

Shut down the Engine (The flywheel will continue to rotate for a while after the engine is shut off), Wait 5 minutes for the engine to cool and all moving parts to come to a complete stop, remove spark plug wire and disconnect the negative battery cable before moving or working on the chipper.

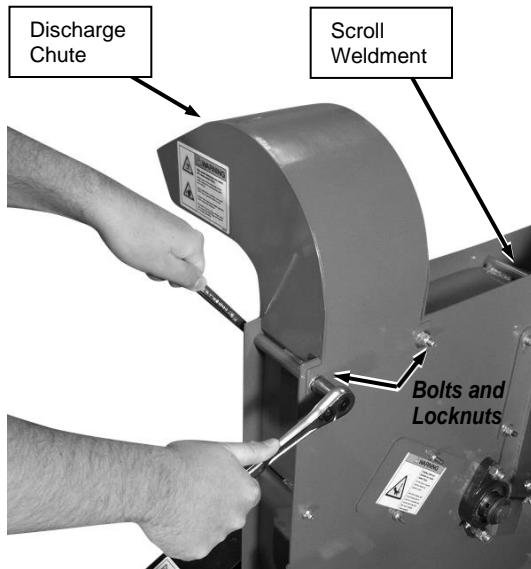

Figure 64

Extended Top-Discharge Chute

The Extended Top-Discharge Chute enables you to better control the direction of the discharged chips and allows you to direct them into a trailer or truck bed for transport.

Tools Needed:

- Two 1/2" Wrenches

INSTALLATION

1. Remove the two Bolts and Locknuts from the Discharge Chute with two 1/2" wrenches (**Figure 64**).
2. Remove the Discharge Chute from the Chipper.
3. Position the Extended Top-Discharge Chute onto the Chipper with the Locking pin on the outside (side furthest away from the hopper) (**Figure 65**).
4. Install the two Bolts and Locknuts and tighten with two 1/2" Wrenches.

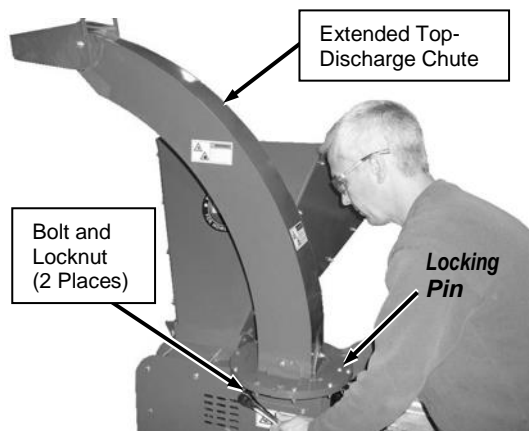

Figure 65

OPERATION

Adjusting the Extended Top-Discharge Chute Discharge Direction:

1. Pull the Hitch Clip and remove the Locking Pin (**Figure 66**).
2. Rotate the Extended Top-Discharge Chute to the direction desired.

Note: The Extended Top-Discharge Chute has a range of motion of 180° that spans the front and both sides of the Chipper. There are 11 different hole settings at 18° increments that you can use.

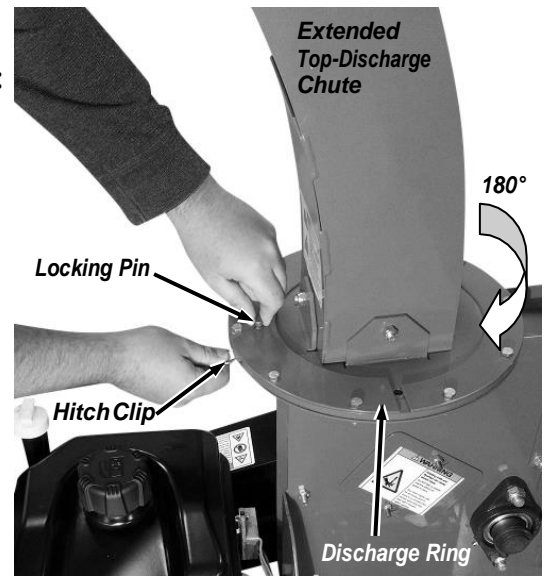

Figure 66

! WARNING

When properly installed, it is not possible to point the Extended Top-Discharge toward the operator position. Confirm that the 180° range of motion is away from the operator zone. Contact us at www.MacKissic.com or call (800)348-1117 if you need assistance.

3. Line up the Locking Pin hole to the closest hole setting in the Discharge Ring.
4. Install the Locking Pin and secure it with the Hitch Clip.

Adjusting the Deflector Direction:

1. Grab the Deflector Handle and rotate the Deflector to the desired discharge position (**Figure 67**).

Note: The deflector bolt should be snug, but still allow the deflector to be re-positioned. Adjust the Bolt tightness if necessary.

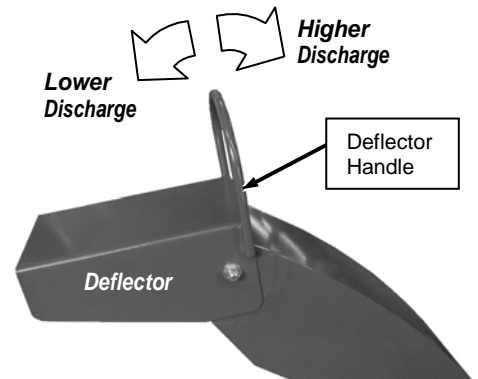

Figure 67

MAINTENANCE

Tools and Supplies Needed:

- All Purpose Grease

Lubricating the Extended Top-Discharge Chute:

1. Pull the Hitch Clip and remove the Locking Pin from the Discharge Ring (**Figure 66**).
2. Apply some all-purpose grease in each hole of the Discharge Ring and Center Ring as you rotate the Chute.
3. Rotate the Extended Top-Discharge Chute for the full 180° of rotation for a few times to spread the grease inside the Discharge Ring.
4. Reposition the Extended Top-Discharge Chute to the desired angle and insert the Locking Pin and Hitch Clip.

TOWING

1. Pull the Hitch Clip and remove the Locking Pin (**Figure 68**).
2. Rotate the Extended Top-Discharge Chute so it is pointed towards the back of the machine.
3. Line up the Locking Pin hole to the closest hole setting in the Discharge Ring.
4. Install the Locking Pin and secure it with the Hitch Clip.



Figure 68

! WARNING

For towing safety, the Extended Top Discharge Chute must be positioned towards the back of the machine. Never tow with it positioned to the side.

CONTACT US AT www.MacKissic.com 43

Chapter 7: Parts List and Schematic Diagrams

Parts List – Drive Assembly

Note: Part numbers listed are available through MacKissic. Ref#

Part#	Description	Ref#	Part#	Description
1	950-2106-BL Base, (WC475)	20	090-0066	Bolt, HCS, 5/16-18 x 3/4
	950-3106-BL Base, (WC575E)	21	090-0720	Shim, Shaft, 1/-1/4, .125 Thk
2	030-0603 Engine, B&S, WC475 TQ, M/S		030-0452	Shim, Shaft, 1/-1/4, .075 Thk
	030-0602 Engine, B&S, WC475 TQ, E/S		030-0451	Shim, Shaft, 1/-1/4, .050 Thk
	030-0607 Engine, B&S, WC575E TQ, E/S		030-0450	Shim, Shaft, 1/-1/4, .025 Thk
3	090-0113 Bolt, HCS, 3/8-16 x 1-3/4, Gr5	22	950-2201	Chipper Basic Assembly, (WC475)
4	090-0234 Washer, Flat, 3/8		950-3201	Chipper Basic Assembly, (WC575E)
5	090-0461 Nut, Nylon Lock, 3/8-16	23	090-0110	Bolt, HCS, 3/8-16 x 1, Gr5
6	900-0360 Belt Tensioner	24	090-0702	Bolt, HCS, 5/16-18 x 4-1/2, Gr5
7	090-0233 Washer, Flat, 5/16	25	950-2113-GR	Discharge
8	090-0460 Nut, Nylon Lock, 5/16-18	26	030-0244	Battery, 12V, 7.2AH (WC475E)
9	080-0080 Key, 1/4" x 1/4" x 2"		911-0250	Battery, SLA, 12V, 17AH (WC575E)
10	030-0611 Clutch, 1 Groove, (WC475)	27	930-2086	Strap, Battery, Rod (WC475E)
	030-0612 Clutch, 2 Groove, (WC575E)		930-3086	Strap, Battery, Rod (WC575E)
11	090-0709 Washer, .47 ID X OD X .15 Thk	28	090-0245	Washer, Flat, 1/4
12	090-0230 Washer, Lock, 7/16, Split	29	090-0470	Nut, Nylon Lock, 1/4-20
13	090-0153 Bolt, HCS 7/16-20 x 1-1/4, Gr8	30	950-2206	Hopper Assembly, (WC475)
14	030-0616 Belt, 5L550, (WC475)		950-3206	Hopper Assembly, (WC575E)
	030-0617 Belt, 5L640, (WC575E)	31	940-2016L-GR	Arm, Bolt On, LH, (WC475)
15	030-0609 Pulley, 1 Groove, (WC475)		940-3016L-GR	Arm, Bolt On, LH, (WC575E)
	030-0626 Sheave, 2 Groove, (WC575E)	32	940-2016R-GR	Arm, Bolt On, RH, (WC475)
	030-0624 Bushing, Sheave (WC575E)		940-3016R-GR	Arm, Bolt On, RH, (WC575E)
16	940-2094 Belt Guard Assembly, (WC475)	33	090-0088	Bolt, HCS, 5/16-18 X 1"
	940-3094 Belt Guard Assembly, (WC575E)	34	940-1096-BL	Guard, Belt, Inner
17	940-1019 Bracket, Belt Guard, (WC475)	35	090-0162	Screw, Self-Tapping, 10-32 X 3/8"
	37760 Bracket, Belt Guard, Upper, (WC575E)			
18	940-1019 Bracket, Belt Guard, (WC475)			
	37761 Bracket, Belt Guard, Lower, (WC575E)			
19	940-1019-BL Bracket, Belt Guard, (WC475)			
	940-3021-BL Bracket, Belt Guard, Base, (WC575E)			

Not Shown

091-0043	Label, Check Oil
930-0002	Label, Danger, Read Manual
930-0004	Label, Danger, Rotating Parts
930-0010	Label, Warning, High Speed Discharge
930-0011	Label, Danger, Rotating Knife & Flywheel
930-0014	Label, Warning, Do Not Climb
805-0329	Cable, Battery, Positive (WC475E)
030-0619	Cable, Battery, Positive (WC575E)
805-0330	Cable, Battery, Negative (WC475E)
030-0620	Cable, Battery, Negative (WC575E)

Schematic – Drive Assembly

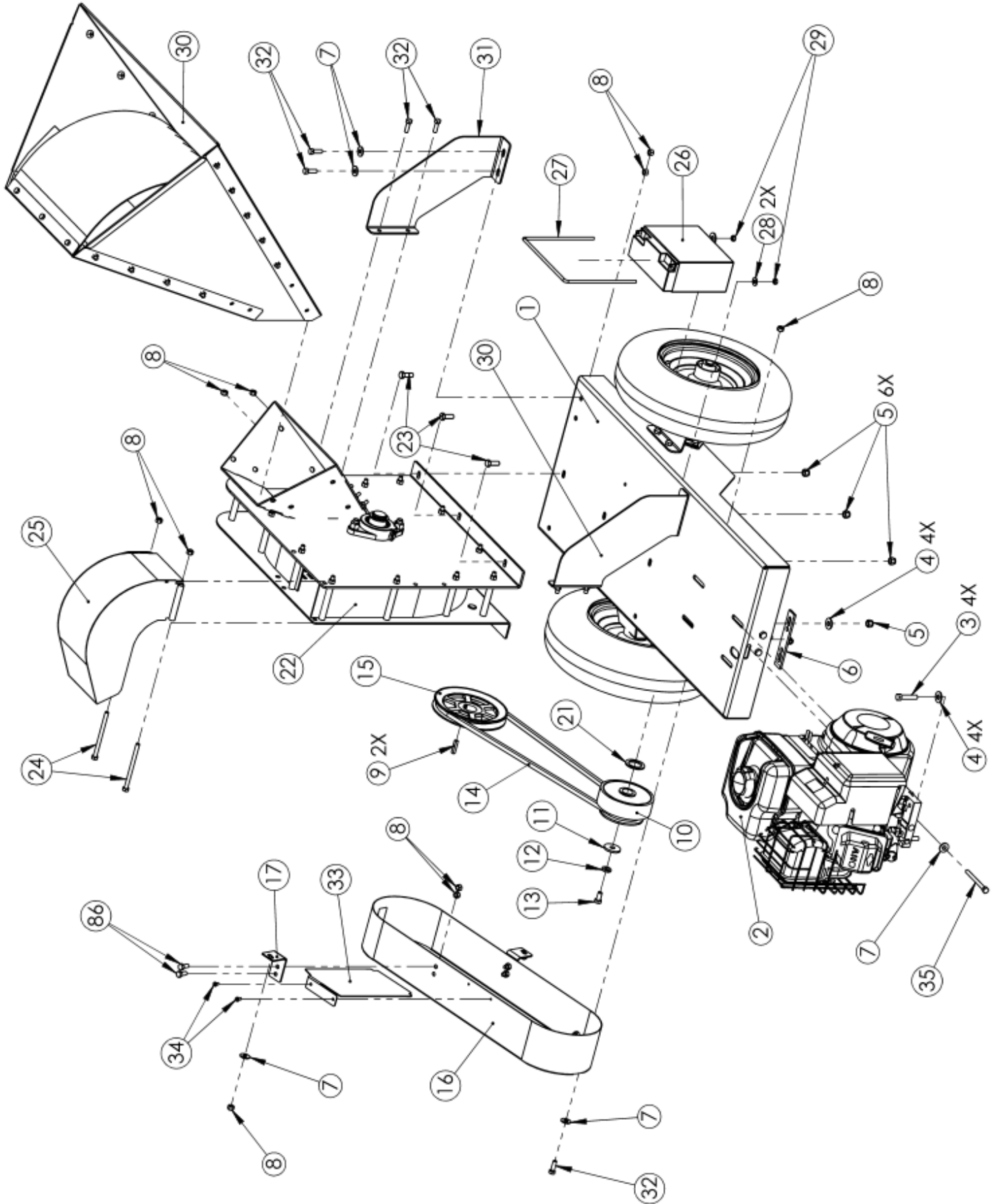

Parts List - Chipper Basic Assembly

Note: Part numbers listed are available through MacKissic.

<u>Ref#</u>	<u>Part#</u>	<u>Description</u>	<u>Ref#</u>	<u>Part#</u>	<u>Description</u>
1	950-2104-GR	Sideplate Weldment, Chute (WC475)	11	090-0141	Bolt, HCS, 1/2-13 x 1-1/2, Gr5
	950-3104-GR	Sideplate Weldment, Chute (WC575E)	12	090-0050	Nut, Lock, 1/2-13, Gripco
2	940-2107-GR	Scroll Weldment, (WC475)	13	940-2023	Plate, Wear, (WC475)
	950-3107-GR	Scroll Weldment, (WC575E)		940-3023	Plate, Wear, (WC575E)
3	950-2103-GR	Sideplate Weldment, Vent, (WC475)	14	090-0677	Bolt, Carriage, 1/4-20 x1
	950-3103-GR	Sideplate Weldment, Vent, (WC575E)	15	090-0245	Washer, Flat, 1/4
4	090-0702	Bolt, HCS, 5/16-18 x 4-1/2, Gr5	16	090-0470	Nut, Nylon Lock, 1/4-20
5	090-0048	Nut, Lock, 5/16-18, Gripco	17	940 -2046-GR	Plate, Access, 3 Hole, (WC475)
6	940-2017-GR	Tube, Scroll		940-3046-GR	Plate, Access, 3 Hole, (WC575E)
7	940-2250	Flywheel, Balanced w/Knife, (WC475)	18	940-2012-GR	Plate, Access, 2 Hole, (WC475)
	940-3250	Flywheel, Balanced w/ Knife, (WC575E)		940-3012-GR	Plate, Access, 2 Hole, (WC575E)
8	030-0530	Bearing, Flange, 1-1/4" Shaft	19	940-2005	Knife Kit, (WC475)
9*	090-0720	Shim, Shaft, 1/-1/4, .125 Thk		940-3005	Knife Kit, (WC575E)
	030-0452	Shim, Shaft, 1/-1/4, .075Thk	<u>Not Shown</u>		
	030-0451	Shim, Shaft, 1/-1/4, .050Thk	930-0001	Label, Warning, Rotating Knife	
	030-0450	Shim, Shaft, 1/-1/4 .025Thk	930-0009	Label, Danger, Rotating Parts Inside	
10	030-0449	Ring, Retaining, 1-1/4 Shaft			

Schematic – Chipper Basic Assembly

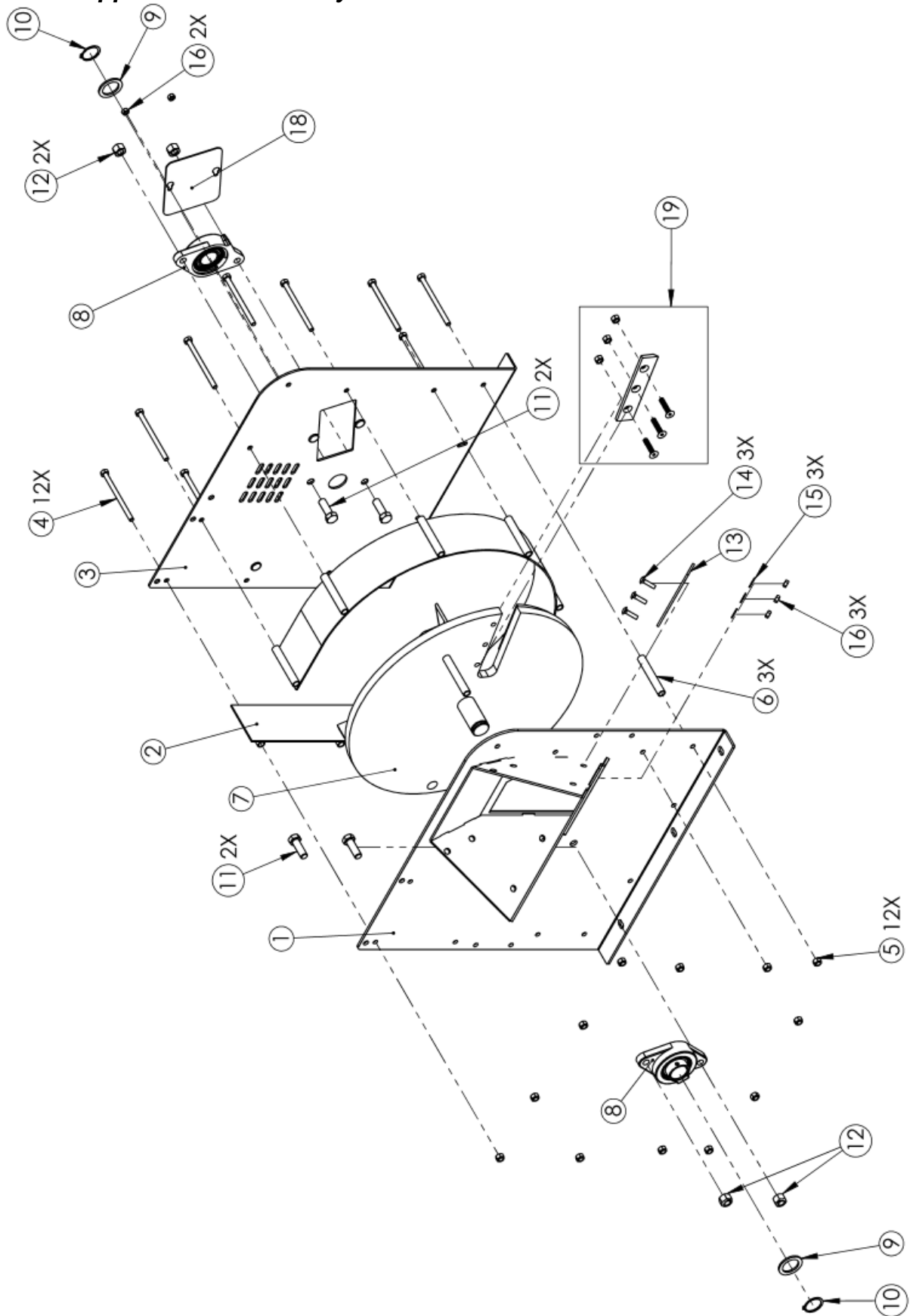

Parts List– Base and Wheels Assembly

Note: Part numbers listed are available through MacKissic.

<u>Ref#</u>	<u>Part#</u>	<u>Description</u>	<u>Ref#</u>	<u>Part#</u>	<u>Description</u>
1	950-2106-BL	Base, (WC475)	11	940-2043-BL	Tow Bar
	950-3106-BL	Base, (WC575E)	12	913-0008-BL	Hitch Plate, Tow Bar
2	940-2032-BL	Axle, (WC475)	13	090-0088	Bolt, 5/16-18 x 1, Gr5
	940-3032-BL	Axle, (WC575E)	14	090-0460	Nut, Nylon Locks, 5/16-18
3	030-0618	Bearing Flange, Axle	15	940-2031-BL	Leg, Support, (WC475)
4	090-0110	Bolt, HCS, 3/8-16 x 1, Gr5	16	090-0116	Bolt, HCS, 3/8-16 x 3, Gr5
5	090-0461	Nut, Nylon Lock, 3/8-16	17	090-0749	Pin, Clevis w/Ring
6	940-2033	Spacer, Wheel, (WC475)	18	706-0924	Pin, Cotter, 1/8"
	940-3033	Spacer, Wheel, Long (WC575E)	19	940-2021-BL	Bracket, Tow Bar, Front
7	940-2033	Spacer, Wheel, (WC475)	20	940-2018-BL	Bracket, Tow Bar, Rear
	940-3036	Spacer, Wheel, Short (WC475)	21	090-0610	U Bolt
8	940-2047	Support, Axle, (WC475)	22	090-0470	Nut, Nylon Lock, 1/4-20
	940-3047	Support, Axle, (WC575E)			
9	030-0642	Wheel, 4.10/3.50-6		<u>Not Shown</u>	
10	090-0730	Collar, Locking, 3/4" Shaft		930-0002	Label, Danger, Read Manual
				930-0008	Label, Danger, 10 mph
				930-0014	Label, Warning, Do Not Climb

Schematic – Base and Wheels Assembly

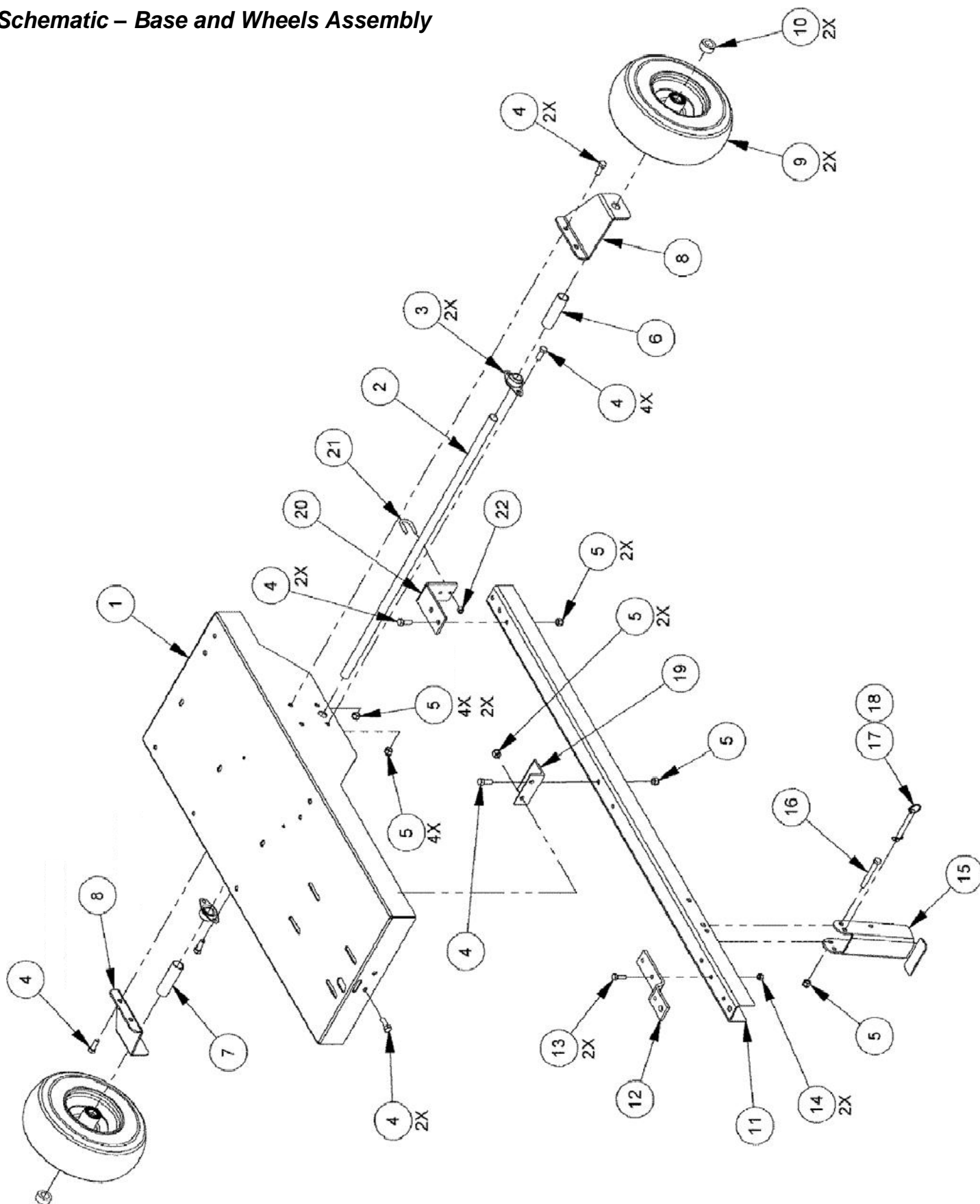

Parts List– Base and Wheels Assembly– Road Tow

Note: Part numbers listed are available through MacKissic.

<u>Ref#</u>	<u>Part#</u>	<u>Description</u>	<u>Ref#</u>	<u>Part#</u>	<u>Description</u>
1	950-2106-BL	Base, (WC475)	16	090-0116	Bolt, HCS, 3/8-16 x 3, Gr5
	950-3106-BL	Base, (WC575E)	17	940-2024-BL	Tow Bar, Road Tow
2	940-2019-BL	Bracket, Axle	18	940-2021-BL	Bracket, Tow Bar, Front
3	940-2025L-BL	Bracket, Fender, (WC475)	19	913-0218	Hitch, Trailer
	940-3025-BL	Bracket, Fender, (WC575E)	20	090-0370	Bolt, HCS, 1/2-13 x 3, Gr5
4	940-2025R-BL	Bracket, Fender, RH, (WC475)	21	090-0629	Nut, Nylon Lock, 1/2-13
	940-3025-BL	Bracket, Fender, (WC575E)	22	912-3522	Chain, Safety, Class 1
5	090-0111	Bolt, HCS, 3/8-16 x 1-1/4, Gr5	23	090-0123	Bolt, HCS, 3/8-16 x 3-1/2, Gr5
6	090-0461	Nut, Nylon Lock, 3/8-16	24	090-0234	Washer, Flat, 3/8
7	930-2122-BL	Fender	25	940-2042-BL	Leg, Support, Road Tow
8	090-0110	Bolt, HCS, 3/8-16 x 1, Gr5	26	090-0749	Clevis Pin w/Ring
9	030-0266	Light, Stop, Road Side	27	706-0924	Pin, Cotter, 1/8"
10	030-0265	Light, Stop, Curb Side			
11	090-0066	Bolt, HCS, 5/16-18 x 3/4			
12	090-0460	Nut, Nylon Lock, 5/16-18			
13	900-0250-BL	Axle Weldment, Road Tow			
14	702-0040	Wheel & Tire Assembly, w/Hub			
15	940-2020-BL	Bracket, Tow Bar, Rear			

Not Shown

930-0002	Label, Danger, Read Manual
930-0003	Label, Danger, 45 mph
930-0014	Label, Warning, Do Not Climb
030-0267	Wire Harness, 10ft

Parts List – Hopper Assembly

Note: Part numbers listed are available through MacKissic.

<u>Ref#</u>	<u>Part#</u>	<u>Description</u>
-------------	--------------	--------------------

1	940-2080-GR	Hopper, Top, (WC475)
	950-3080-GR	Hopper, Top, (WC575E)
2	940-2081-GR	Hopper, Bottom, (WC475)
	950-3081-GR	Hopper, Bottom, (WC575E)
3	940-2082L-GR	Hopper, Side, LH, (WC475)
	950-3082L-GR	Hopper, Side, LH, (WC575E)
4	940-2082R-GR	Hopper, Side, RH, (WC475)
	950-3082R-GR	Hopper, Side, RH, (WC575E)
5	090-0748	Bolt, Philips Head, 5/16-18 x 3/4"
6	090-0731	Bolt, Philips Head, 5/16-18 x 1/2"

<u>Ref#</u>	<u>Part#</u>	<u>Description</u>
-------------	--------------	--------------------

7	090-0639	Nut, Nylon Lock, 5/16-18, LP
8	940-2071	Shield, Blow Back, (WC475)
	940-3071	Shield, Blow Back, (WC575E)
9	940-0543	Support, Blow Back, (WC475)
	940-0542	Support, Blow Back, (WC575E)
10	090-0012	Bolt, HCS, 1/4-20 x 3/4, Gr5
11	090-0232	Washer, Flat, 1/4
12	090-0470	Nut, Nylon Lock, 1/4-20

Not Shown

930-0013	Label, Danger, Safety
----------	-----------------------

Schematic – Hopper Assembly

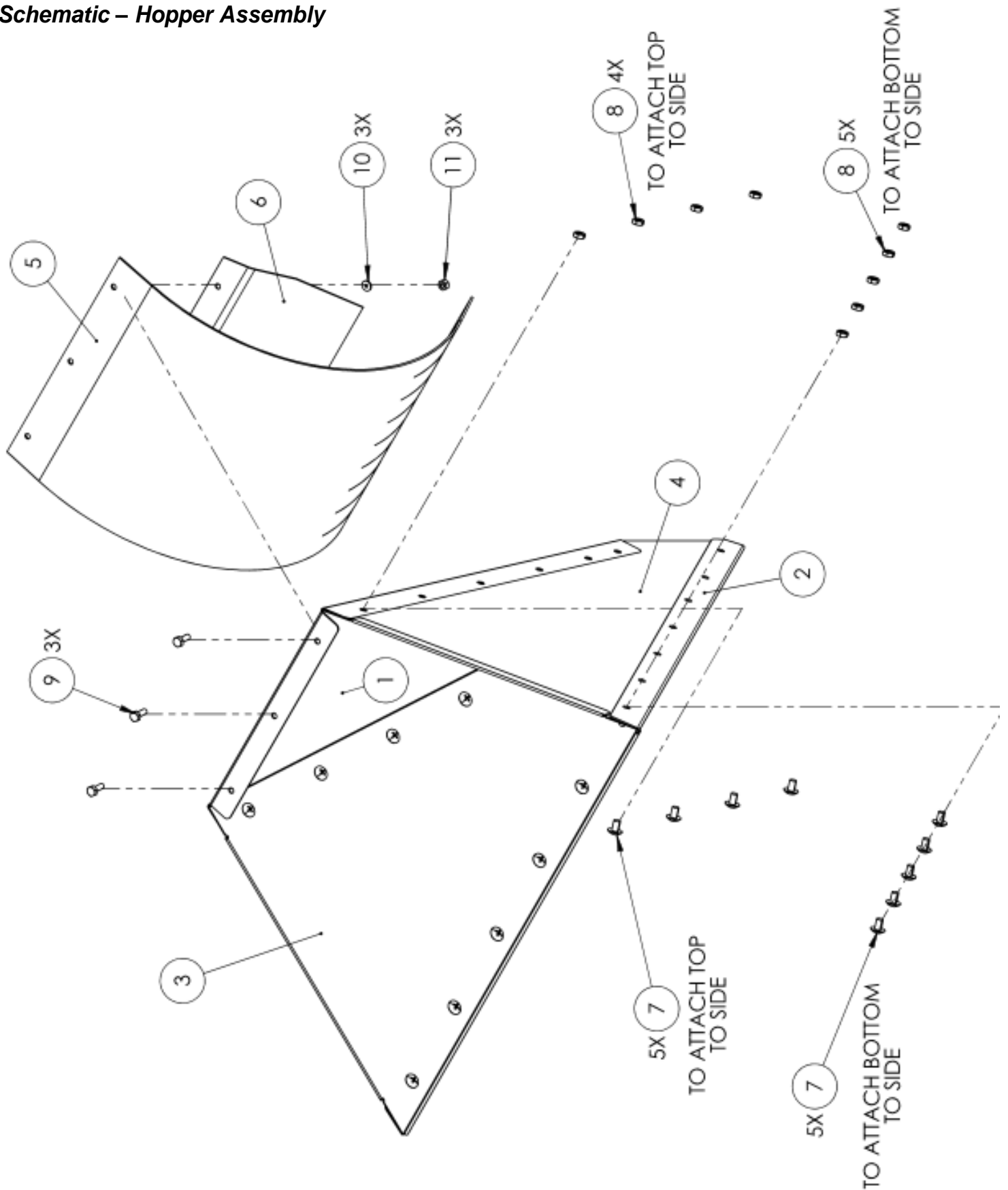

Parts List – High Discharge Accessory

NOTE: Part numbers listed are available through MacKissic.

Ref# Part# Description

01	930-2120-GR	Deflector Weldment
02	090-0066	Bolt, HCS, 5/16-18 x 3/4"
03	090-0476	SAE Washer, Flat, 5/16
04	090-0460	Nut, Nylon Lock, 5/16-18
05	930-2119	High Discharge Weldment
06	708-3211	Pin, Locking
07	090-0060	Bolt, HCS, 1/4-20 X 1, Gr5
08	930-2064-GR	Swivel Top, Pin Side
09	930-2063-GR	Spacer, Swivel
10	940-2077-GR	Flange, Side, HD

Ref# Part# Description

11	090-0470	Nut, Nylon Lock, 1/4-20
12	706-0924	Hair Spring Cotter
13	940-2078-GR	Plate, Bottom
14	930-2118-GR	Swivel Weldment
15	930-2065-GR	Swivel Top

Not Shown

930-0010 Label, Warning, High
 Speed Discharge 930-0011 Label,
 Danger, Rotating Knife & Flywheel

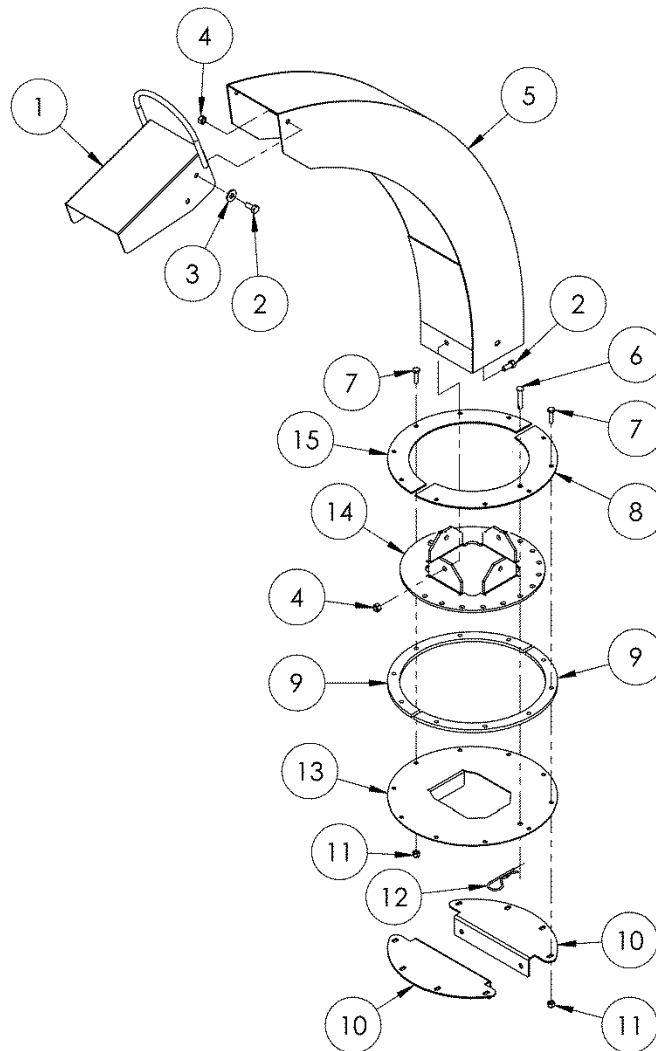

Notes:

Notes:

Daily Checklist for the GRAVITY SELF-FEEDING WOOD CHIPPER

WARNING

Shut down the Engine (The flywheel will continue to rotate for a while after the engine is shut off), Wait 5 minutes for the engine to cool and all moving parts to come to a complete stop, remove spark plug wire and disconnect the negative battery cable before moving or working on the chipper.

To help maintain your GRAVITY SELF-FEEDING WOOD CHIPPER for optimum performance, we recommend you follow this checklist each time you use your Chipper.

[] **OIL:** With the machine on a level surface, check the Engine oil level with the Dipstick and add more if necessary (only add oil to the level indicated on the Dipstick - DO NOT OVERFILL). Use SAE 30 high detergent motor oil.

[] **GAS:** Fill the Fuel Tank with clean, fresh, unleaded gasoline.

[] **ENGINE AIR COOLING SYSTEM:** It is very important to keep the Engine clean of debris. Remove leaves and other built-up materials from the Air Intake Screen before, during, and after using the Chipper. Regularly remove debris from the Cooling Fins. A dirty Engine retains heat and can cause damage to the internal Engine parts.

[] **BELT:** Check the Belt for wear, proper alignment and tension.

[] **KNIFE and WEAR PLATE:** Check the Knife and Wear Plate for tightness, nicks and wear.

[] **GENERAL CONDITION:** Check the general condition of the machine, e.g.; nuts, bolts, welds, etc. [] **HOPPER:** Check that there is no material left in the hopper before starting the Chipper.

[] **TIRES:** Check that there the proper amount of air in the Tires.

End of Season and Storage

WARNING

- Shut down the Engine (The flywheel will continue to rotate for a while after the engine is shut off), Wait 5 minutes for the engine to cool and all moving parts to come to a complete stop, remove spark plug wire and disconnect the negative battery cable before moving or working on the chipper.
 - Never store the GRAVITY SELF-FEEDING WOOD CHIPPER with fuel in the fuel tank inside a building where ignition sources are present, such as hot water and space heaters, clothes dryers and the like. If you are going to drain the fuel tank, do this outdoors. Allow the engine to cool before storing in any enclosure.
 - When not in use, your GRAVITY SELF-FEEDING WOOD CHIPPER should be stored out of the reach of children.
-

Note: Please refer to the Engine Owner's Manual for engine-specific procedures.

- Change the oil (and oil filter, if applicable).
 - If your GRAVITY SELF-FEEDING WOOD CHIPPER will be idle for more than 30 days, we recommend using a gas stabilizer. This will prevent sediment from gumming up the carburetor. If there is dirt or moisture in the gas or tank, remove it by draining the tank. Completely fill the tank with fresh, unleaded gas and add the appropriate amount of stabilizer or gasoline additive. Run the engine for a short time to allow the additive to circulate. Close the fuel Shut-Off Valve to prevent carburetor overflow and leakage.
 - Remove the spark plug and pour about 1 ounce of motor oil into the cylinder hole. Reinstall the plug and engage the electric starter for a few seconds (for manual start pull on the starter cord a few times). This will coat the pistons and seat the valves to prevent moisture buildup.
 - Clean or replace the air filter(s).
 - Lubricate all grease fittings.
 - Clean any dirt and debris from the cylinder head cooling fins, blower housing, debris screen and muffler area of the engine.
 - If your engine has a fuel filter, replace it.
 - Check the Drive Belt for wear.
 - Check the Chipper Knife and Wear Plate for nicks and wear.
 - For electric start models remove the battery or store your GRAVITY SELF-FEEDING WOOD CHIPPER in a dry environment where the temperature is between -10° F (-23° C) and $+85^{\circ}\text{ F}$ ($+23^{\circ}\text{ C}$). Make sure the storage temperatures will never be outside these limits.
 - Clean any debris from the Hopper and Discharge Chute.
-