



LG

Life's Good

ENGLISH

FRANÇAIS

ESPAÑOL

INSTALLATION MANUAL AIR CONDITIONER

- Please read this installation manual completely before installing the product.
- Installation work must be performed in accordance with the national wiring standards by authorized personnel only.
- Please retain this installation manual for future reference after reading it thoroughly.

TYPE : WALL MOUNTED

<http://www.lghvac.com>
www.lg.com



P/NO : MFL68019901

FLEX MULTI SPLIT INSTALLATION INSTRUCTIONS

IMPORTANT!

Please read this instruction sheet completely before installing the product.

This air conditioning system meets strict safety and operating standards. As the installer or service person, it is an important part of your job to install or service the system so it operates safely and efficiently.



WARNING

- Installation or repairs made by unqualified persons can result in hazards to you and others. Installation MUST comply with local building codes or, in the absence of local codes, with the National Electrical Code NFPA 70/ANSI C1-1993 or current edition and Canadian Electrical Code Part1 CSA C.22.1.
- The information contained in this manual is intended for use by a qualified service technician familiar with safety procedures and equipped with the proper tools and test instruments.
- Failure to carefully read and follow all instructions in this manual can result in equipment malfunction, property damage, personal injury and/or death.

CAUTION: Improper installation, adjustment, alteration, service or maintenance can void the warranty. The weight of the condensing unit requires caution and proper handling procedures when lifting or moving to avoid personal injury. Use care to avoid contact with sharp or pointed edges.

Safety Precautions

- Always wear safety glasses and work gloves when installing equipment.
- Never assume electrical power is disconnected. Check with meter and equipment.
- Keep hands out of fan areas when power is connected to equipment.
- R410A causes frostbite burns.
- R410A is toxic when burned.

NOTE TO INSTALLING DEALER : The Owners Instructions and Warranty are to be given to the owner or prominently displayed near the indoor Air Handler Unit.



WARNING

When wiring:

Electrical shock can cause severe personal injury or death. Only a qualified, experienced electrician should attempt to wire this system.

- Do not supply power to the unit until all wiring and tubing are completed or reconnected and checked.
- Highly dangerous electrical voltages are used in this system. Carefully refer to the wiring diagram and these instructions when wiring. Improper connections and inadequate grounding can cause accidental injury or death.
- Ground the unit following local electrical codes.
- Connect all wiring tightly. Loose wiring may cause overheating at connection points and a possible fire hazard.

When transporting:

Be careful when picking up and moving the indoor and outdoor units. Get a partner to help, and bend your knees when lifting to reduce strain on your back. Sharp edges or thin aluminum fins on the air conditioner can cut your fingers.

When installing...

... in a wall: Make sure the wall is strong enough to hold the unit's weight.

It may be necessary to construct a strong wood or metal frame to provide added support.

... in a room: Properly insulate any tubing run inside a room to prevent "sweating" that can cause dripping and water damage to wall and floors.

... in moist or uneven locations: Use a raised concrete pad or concrete blocks provide a solid, level foundation for the outdoor unit. This prevents water damage and abnormal vibration.

... in an area with high winds: Securely anchor the outdoor unit down with bolts and a metal frame. Provide a suitable air baffle.

... in a snowy area(for Heat Pump Model): Install the outdoor unit on a raised platform that is higher than drifting snow. Provide snow vents.

When connecting refrigerant tubing

- Keep all tubing runs as short as possible.
- Use the flare method for connecting tubing.
- Check carefully for leaks before starting the test run.

When servicing

- Turn the power OFF at the main power box(mains) before opening the unit to check or repair electrical parts and wiring.
- Keep your fingers and clothing away from any moving parts.
- Clean up the site after you finish, remembering to check that no metal scraps or bits of wiring have been left inside the unit being serviced.

TABLE OF CONTENTS

Installation Requirements

Installation Parts Provided	4
Product Introduction	4
Indoor Unit.....	4
Outdoor Unit.....	4
Safety Precautions	5
Installation of Indoor, Outdoor Unit	8
Select the best location	8
Installation	9
Preparing work for Installation.....	9
Sticking the installation guide map and fixing Indoor unit.....	10
Drill a hole in the wall	10
Installation of Wired Remote Controller(Optional).....	11
Flaring Work and Connection of Piping	13
Flaring work.....	13
Connection of piping - Indoor	14
Connecting the Cable between Indoor Unit and Outdoor Unit	17
Connect the cable to the Indoor unit	17
Checking the Drainage, Forming the Pipings and Long Pipe Setting	20
Checking the drainage	20
Panel Front Assembly	21

Required Tools

- Level gauge
- Screw driver
- Electric drill
- Hole core drill (ø50mm)

- Flaring tool set
- Specified torque wrenches
1.8kg.m, 4.2kg.m, 5.5kg.m, 6.6kg.m
(different depending on model No.)
- Adjustable wrench





- A glass of water
- Screw driver

- Hexagonal wrench(4mm)
- Refrigerant Gas Leak Detector
- Vacuum pump
- Gauge manifold

- Owner's manual
- Thermometer
- Remote Control Holder

Installation Parts Provided

Installation Parts

Installation guide map	Type "A" screw and plastic anchor
	
Type "B" screw	Remote control holder
	

Product Introduction

Indoor Unit

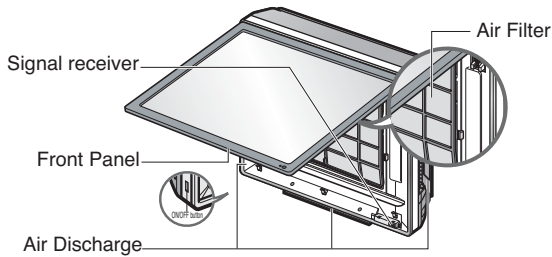

Outdoor Unit

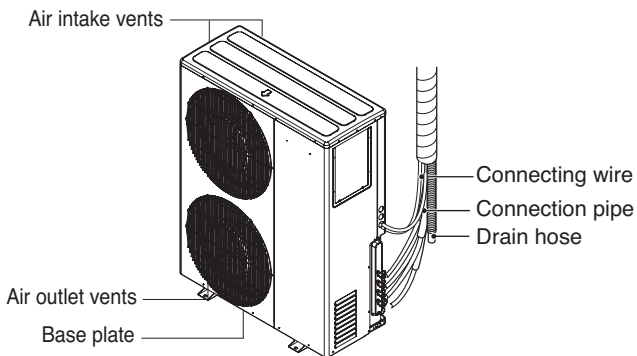

* The figure can be changed according to model.

Safety Precautions

To prevent the injury of the user or other people and property damage, the following instructions must be followed.

- Be sure to read before installing the air conditioner.
- Be sure to observe the cautions specified here as they include important items related to safety.
- Incorrect operation due to ignoring instruction will cause harm or damage. The seriousness is classified by the following indications.

⚠ WARNING This symbol indicates the possibility of death or serious injury.

⚠ CAUTION This symbol indicates the possibility of injury or damage to properties only.

- The meanings of the symbols used in this manual are as shown below.



Be sure not to do.



Be sure to follow the instruction.

⚠ WARNING

■ Installation

Always perform grounding.

- Otherwise, it may cause electrical shock.

Don't use a power cable, a plug or a loose socket which is damaged.

- Otherwise, it may cause a fire or electrical shock.

For installation of the product, always contact the service center or a professional installation agency.

- Otherwise, it may cause a fire, electrical shock, explosion or injury.

Securely attach the electrical part cover to the indoor unit and the service panel to the outdoor unit.

- If the electrical part cover of the indoor unit and the service panel of the outdoor unit are not attached securely, it could result in a fire or electric shock due to dust, water, etc.

Always install an air leakage breaker and a dedicated switching board.

- No installation may cause a fire and electrical shock.

Do not keep or use flammable gases or combustibles near the air conditioner.

- Otherwise, it may cause a fire or the failure of product.

Ensure that an installation frame of the outdoor unit is not damaged due to use for a long time.

- It may cause injury or an accident.

Do not disassemble or repair the product randomly.

- It will cause a fire or electrical shock.

Do not install the product at a place that there is concern of falling down.

- Otherwise, it may result in personal injury.

Use caution when unpacking and installing.

- Sharp edges may cause injury.

Use a vacuum pump or Inert (nitrogen) gas when doing leakage test or air purge. Do not compress air or Oxygen and Do not use Flammable gases. Otherwise, it may cause fire or explosion.

- There is the risk of death, injury, fire or explosion.

Do not install the product on the plaster wall or wooden wall.

- It may cause serious injury, accident, or damage to the product by falling of product.

■ Operation

Do not share the outlet with other appliances.

- It will cause an electric shock or a fire due to heat generation.

Do not use the damaged power cable.

- Otherwise, it may cause a fire or electrical shock.

Do not modify or extend the power cable randomly.

- Otherwise, it may cause a fire or electrical shock.

Take care so that the power cable may not be pulled during operation.

- Otherwise, it may cause a fire or electrical shock.

If strange sounds, smell or smoke comes from product. Immediately turn the breaker off or disconnect the power supply cable.

- There is risk of electric shock or fire.

Keep the flames away.

- Otherwise, it may cause a fire.

Do not place a heater or other heating appliances near the power cable.

- There is risk of fire and electric shock.

Do not open the suction inlet of the indoor/outdoor unit during operation.

- Otherwise, it may electrical shock and failure.

Do not allow water to run into electrical parts.

- Otherwise, it may cause the failure of machine or electrical shock.

Never touch the metal parts of the unit when removing the filter.

- They are sharp and may cause injury.

Do not step on the indoor/outdoor unit and do not put anything on it.

- It may cause an injury through dropping of the unit or falling down.

Do not place a heavy object on the power cable.

- Otherwise, it may cause a fire or electrical shock.

When the product is submerged into water, always contact the service center.

- Otherwise, it may cause a fire or electrical shock..

Take care so that children may not step on the outdoor unit.

- Otherwise, children may be seriously injured due to falling down.

 **CAUTION****■ Installation**

Install the drain hose to ensure that drain can be securely done.

- Otherwise, it may cause water leakage.

Always inspect gas leakage after the installation and repair of product.

- Otherwise, it may cause the failure of product.

Install the product so that the noise or hot wind from the outdoor unit may not cause any damage to the neighbors.

- Otherwise, it may cause dispute with the neighbors.

Keep level parallel in installing the product.

- Otherwise, it may cause vibration or water leakage.

■ Operation

Avoid excessive cooling and perform ventilation sometimes.

- Otherwise, it may do harm to your health.

Do not use an appliance for special purposes such as preserving animals vegetables, precision machine, or art articles.

- Otherwise, it may damage your properties.

Use a soft cloth to clean. Do not use wax, thinner, or a strong detergent.

- The appearance of the air conditioner may deteriorate, change color, or develop surface flaws.

Do not place obstacles around the flow inlet or outlet.

- Otherwise, it may cause the failure of appliance or an accident.

Installation of Indoor, Outdoor Unit

Read completely, then follow step by step.

Select the best location

Indoor unit

1. Do not have any heat or steam near the unit.
2. Select a place where there are no obstacles in front of the unit.
3. Make sure that condensation drainage can be conveniently routed away.
4. Do not install near a doorway.
5. Ensure the spaces indicated by arrows from the wall, ceiling, fence or other obstacles.
6. Use a stud finder to locate studs to prevent unnecessary damage to the wall.

CAUTION: Install the indoor unit on the wall where the height from the floors more than 1.5m(4.9ft).

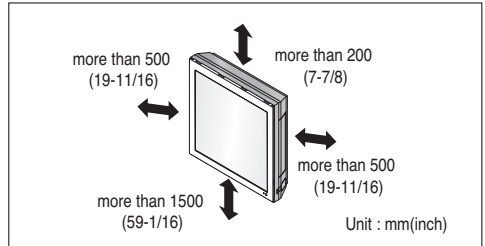

Outdoor unit

1. If an awning is built over the unit to prevent direct sunlight or rain exposure, make sure that heat radiation from the condenser is not restricted.
2. Ensure that the spaces indicated by arrows around front, back and side of the unit.
3. Do not place animals and plants in the path of the warm air.
4. Take the air conditioner weight into account and select a place where noise and vibration are minimum.
5. Select a place so that the warm air and noise from the air conditioner do not disturb neighbors.

Rooftop Installations:

If the outdoor unit is installed on a roof structure, be sure to level the unit. Ensure the roof structure and anchoring method are adequate for the unit location. Consult local codes regarding rooftop mounting.

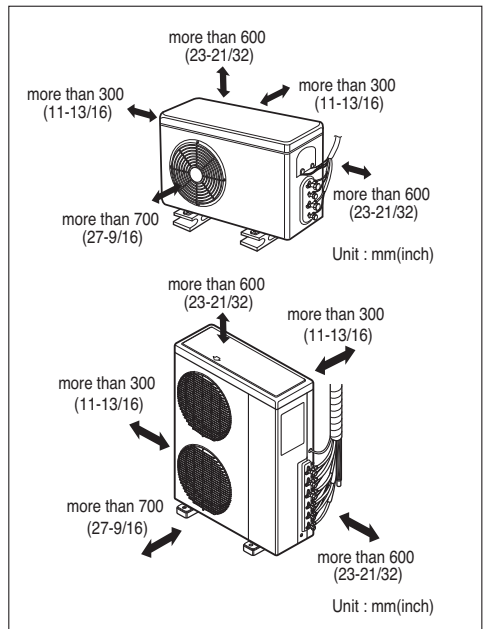

Installation

Preparing work for Installation

Open panel front

1. First, push the front panel backward and lift it up to remove the two screws.
2. The moment of lifting the both lower parts of panel front, you can hear sound this panel came out, In this time panel front is separated
3. After pull down this panel a bit, and separate connecting wire with product.

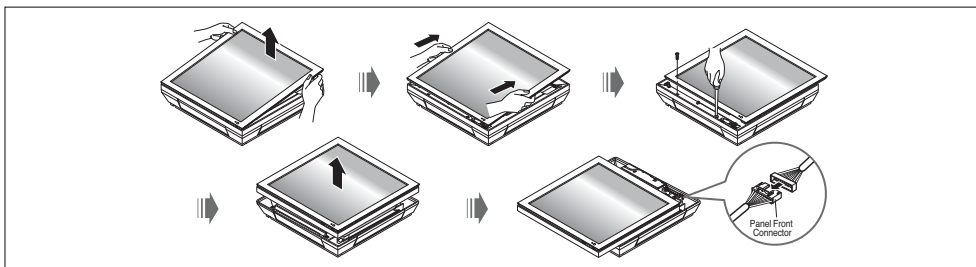

Remove cover pipe and cover side

1. Remove two screws (for fixing cover pipe)
2. Pull up the cover side of desired connecting direction, then cover side is separated.
3. In case of connecting direction is left or right, path through the hole of cover side.



CAUTION: After removing the pipe hole, cut the burr for safety.

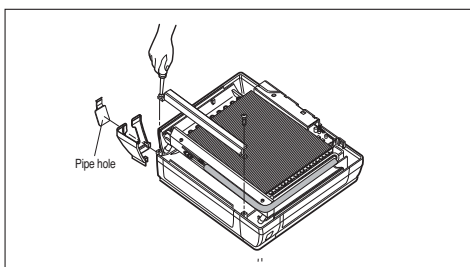

NOTICE When connecting pipe path through rear wall, don't remove the hole.

Drain hose junction

1. Remove the rubber stopple of desired direction of drainage.
2. As the following picture, Insert drain hose in the handle of drain pan, and join drain hose and connecting hose.

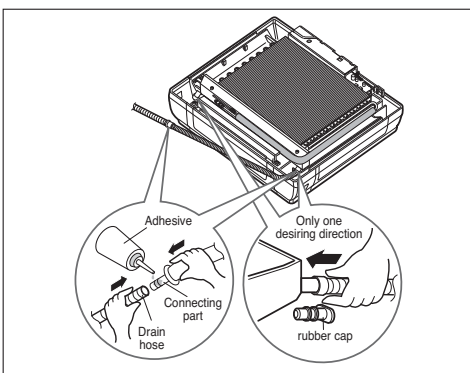

Sticking the installation guide map and fixing Indoor unit

Put an Installation Guide Map on the desired surface.

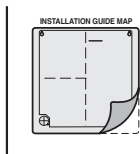

Make a hole with diameter of 6mm and depth of 30-35mm when piercing a screw point.

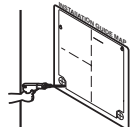

Drive the four plastic anchors into drilled points.

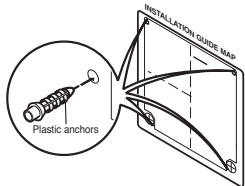

Hang the hole of product at the upper screws.
(In this time, Remove the map)
(Falling attention)

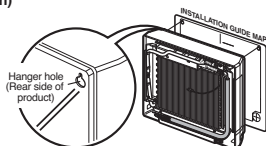

Check the fixed product with light power.

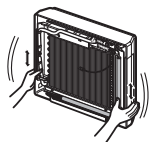

Adjust level even by level guage and fix to installation for reference on the wall.

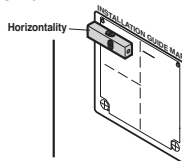

Drill the piercing part for connecting pipe as diameter $\text{\O}65\text{mm}$. (In case of piercing rear surface)

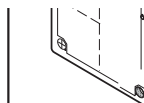

Refer to No. 5 on this page when making a hole in the wall.

First, Drive the two points of the upper parts by screws
(Leave 10mm for hanging product)

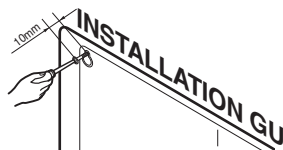

Drive the lower parts after facing the hole of product with plastic anchors, and fix completely the upper screws.

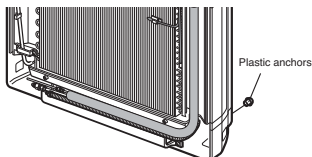

In case of nothing wrong in the matter, connect the pipe and the wire. (Installation manual reference)

Drill a hole in the wall

- Drill the piping hole with a $\text{\O}65\text{mm}$ hole core drill. Drill the piping hole at either the right or the left with the hole slightly slanted to the outdoor side.

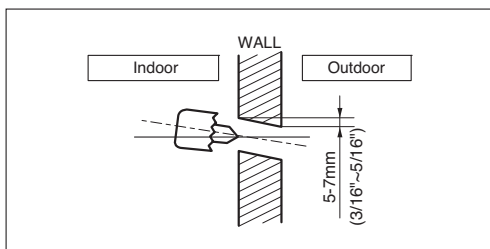

Installation of Wired Remote Controller(Optional)

1. Please fix tightly using provided screw after placing remote controller setup board on the place where you like to setup.

- Please set it up not to bend because poor setup could take place if setup board bends.
Please set up remote controller board fit to the reclamation box if there is a reclamation box.
- Install the product so as not to make a gap with the wall side and to prevent shaking after the installation.

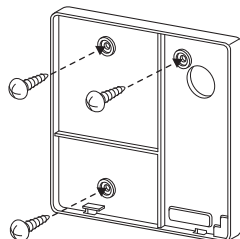

2. Can set up Wired remote controller cable into three directions.

- Setup direction: the surface of wall reclamation, upper, right
- If setting up remote controller cable into upper and right side, please set up after removing remote controller cable guide groove.

※ Remove guide groove with long nose.

- ① Reclamation to the surface of the wall
- ② Upper part guide groove
- ③ Right part guide groove

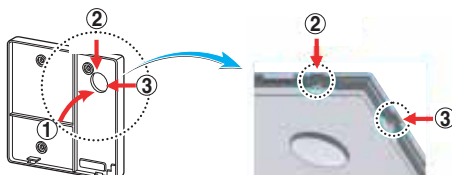

<Wire guide grooves>

3. Please fix remote controller upper part into the setup board attached to the surface of the wall, as the picture below, and then, connect with setup board by pressing lower part.

- Please connect not to make a gap at the remote controller and setup board's upper and lower, right and left part.
- Before assembly with the installation board, arrange the Cable not to interfere with circuit parts.

<Connecting order>

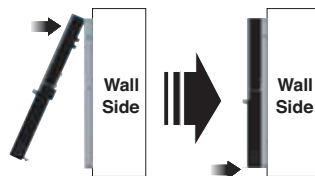

<Separating order>

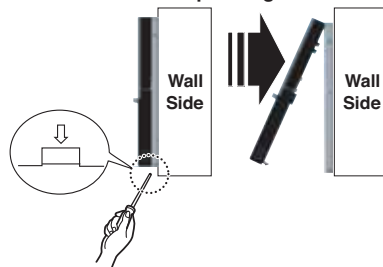

When separating remote controller from setup board, as the picture below, after inserting into the lower separating hole using screw driver and then, spinning clockwise, remote controller is separated.

- There are two separating holes. Please individually separate one at a time.
- Please be careful not to damage the inside components when separating.

4. Please connect indoor unit and remote controller using connection cable.

12V	Red
Signal	Yellow
GND	Black

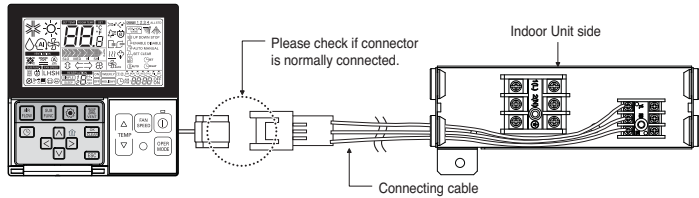

5. Please use extension cable if the distance between wired remote controller and indoor unit is more than 10m(32.8ft).

⚠ CAUTION

When installing the wired remote controller, do not bury it in the wall. (It can cause damage in the temperature sensor.)

Do not install the cable to be 50m(164ft) or above. (It can cause communication error.)

- When installing the extension cable, check the connecting direction of the connector of the remote controller side and the product side for correct installation.
- If you install the extension cable in the opposite direction, the connector will not be connected.
- Specification of extension cable: 2547 1007 22# 2 core 3 shield 5 or above.

6. Since the room temperature sensor is in the remote controller, the remote controller box should be installed in a place away from direct sunlight, high humidity and direct supply of cold air to maintain proper space temperature. Install the remote controller about 5ft(1.5m) above the floor in an area with good air circulation at an average temperature.

7. Do not install the remote controller where it can be affected by:

- Drafts, or dead spots behind doors and in corners.
- Hot or cold air from ducts.
- Radiant heat from sun or appliances.
- Concealed pipes and chimneys.
- Uncontrolled areas such as an outside wall behind the remote controller.
- This remote controller is equipped with a seven segment LED's display. For proper display of the remote controller LED's, the remote controller should be installed properly as shown in Fig.1. (The standard height is 1.2~1.5 m from floor level.)

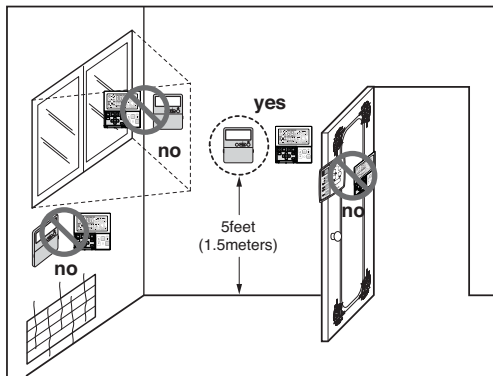

Flaring Work and Connection of Piping

Flaring work

Main cause of gas leakage is defect in flaring work. Carry out correct flaring work in the following procedure.

1. Cut the pipes and the cable.

- Use the accessory piping kit or the pipes purchased locally.
- Measure the distance between the indoor and the outdoor unit.
- Cut the pipes a little longer than measured distance.
- Cut the cable 1.5m(4.9ft) longer than the pipe length.

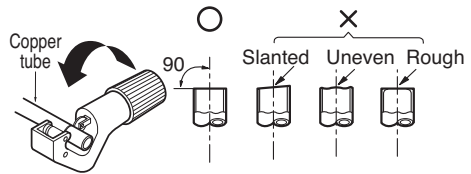

2. Burrs removal

- Completely remove all burrs from the cut cross section of pipe/tube.
- Put the end of the copper tube/pipe to downward direction as you remove burrs in order to avoid to let burrs drop in the tubing.

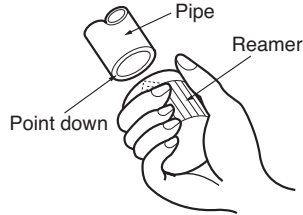

3. Putting nut on

- Remove flare nuts attached to indoor and outdoor units, than put them on pipe/tube having completed burr removal.
- (Not possible to put them on after flaring work)

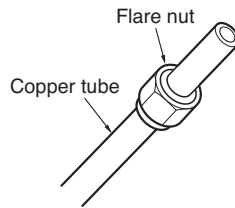

4. Flaring work

- Carry out flaring work using flaring tool as shown below.

Outside diameter		A	
mm	inch	mm	inch
Ø6.35	1/4	1.1~1.3	0.04~0.05
Ø9.52	3/8	1.5~1.7	0.06~0.07
Ø12.7	1/2	1.6~1.8	0.06~0.07

Firmly hold copper tube in a bar(or die) as indicated dimension in the table above.

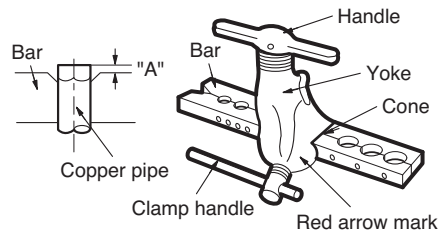

5. Check

- Compare the flared work with figure.
- If flare is noted to be defective, cut off the flared section and do flaring work again.

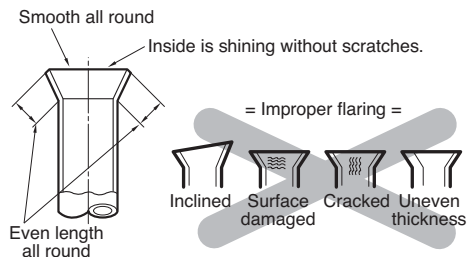

Connection of piping - Indoor

Preparing the indoor unit's piping and drain hose for installation through the wall.

1. Route the indoor tubing and the drain hose in the direction of rear left or right

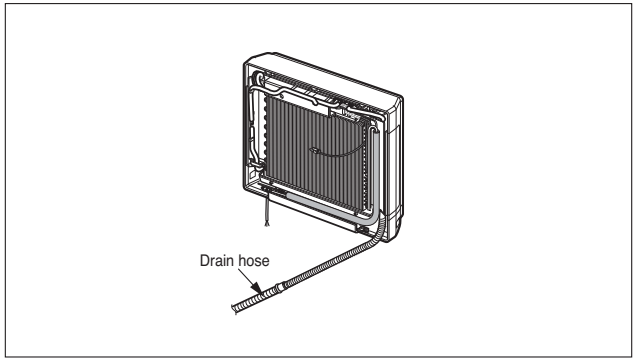

2. Tape the tubing, drain hose and the connecting cable. Be sure that the drain hose is located at the lowest side of the bundle. Locating at the upper side can cause drain pan to overflow inside the unit.

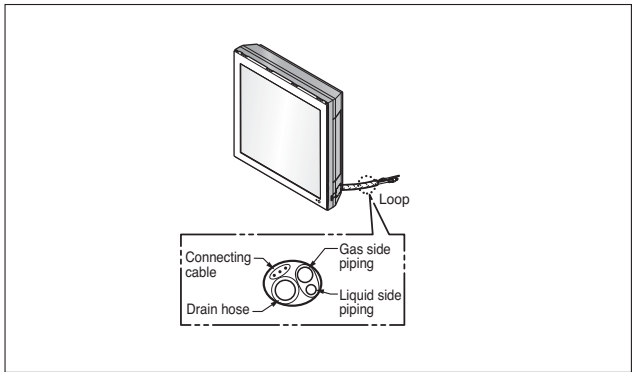

CAUTION: If the drain hose is routed inside the room, insulate the hose with an insulation material* so that dripping from "sweating" (condensation) will not damage furniture or floors.

*Foamed polyethylene or equivalent is recommended.

Connecting the pipings to the indoor unit and drain hose to drain pipe

1. Align the center of the pipings and sufficiently tighten the flare nut by hand.
2. Tighten the flare nut with a wrench.

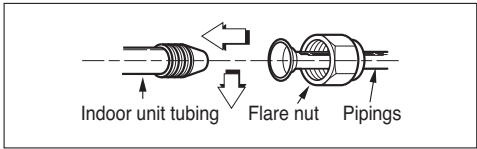

Outside diameter		Torque
mm	inch	kgf·m
Ø6.35	1/4	1.8~2.5
Ø9.52	3/8	3.4~4.2
Ø12.7	1/2	5.5~6.6

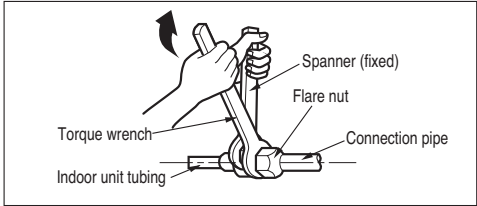

3. When extending the drain hose at the indoor unit, install the drain pipe.

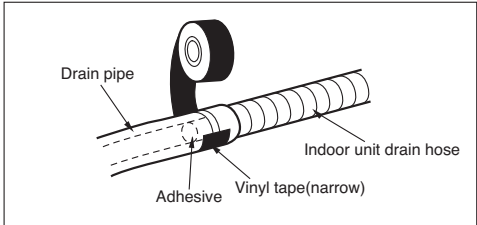

Wrap the insulation material around the connecting portion.

1. Overlap the connection pipe insulation material and the indoor unit pipe insulation material. Bind them together with vinyl tape so that there is no gap.
2. Wrap the area which accommodates the rear piping housing section with vinyl tape.

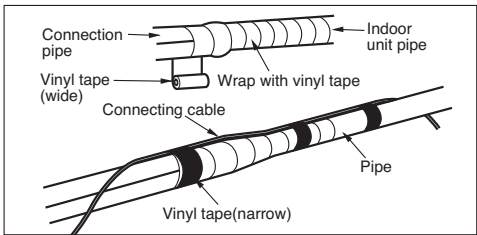
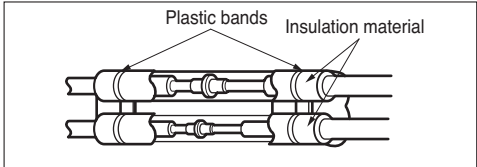

3. Bundle the piping and drain hose together by wrapping them with vinyl tape over the range within which they fit into the rear piping housing section.

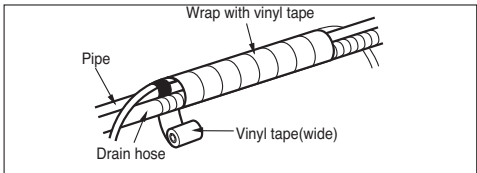

⚠ CAUTION: Installation Information (For right piping)
For right piping, follow the instruction below.

Good case

- Press on the upper side of clamp and unfold the tubing to downward slowly.

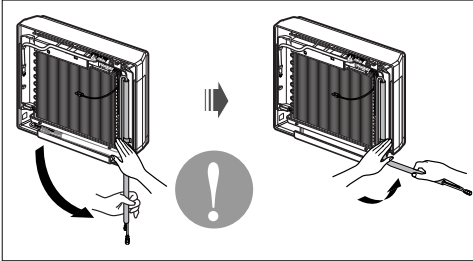

Bad case

- Following bending type from left to right could cause problem of pipe damage.

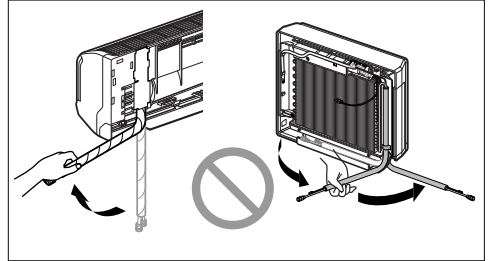

Connecting the Cable between Indoor Unit and Outdoor Unit

Connect the cable to the Indoor unit.

Connect the cable to the indoor unit by connecting the wires to the terminals on the control board individually according to the outdoor unit connection. (Ensure that the color of the wires of the outdoor unit and the terminal No. are the same as those of the indoor unit.)

The ground wire should be longer than the common wires.

The circuit diagram is not subject to change without notice.

When installing, refer to the electrical diagram behind the front panel of Indoor Unit.

The wiring for the outdoor unit can be found on the inside of the Outdoor Unit control cover.



RECOMMENDATION:

- The circuit diagram is subject to change without notice.
- Be sure to connect wires according to the wiring diagram.
- Connect the wires firmly, so that they can not be pulled out easily.
- Connect the wires according to color codes by referring to the wiring diagram.



RECOMMENDATION: The power cord connected to the outdoor unit should comply with the following specifications: NRTL Recognized (for example, UL or ETL recognized and CSA certified).

■ Connecting cable

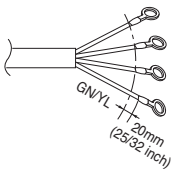

The power connecting cable between the outdoor and indoor units must comply with the following specifications: NRTL Recognized (for example, UL or ETL recognized and CSA certified).

AWG 18 is the minimum recommended wire size, however, the selected conductors must comply with local codes and be suitable for installation in wet locations.



RECOMMENDATION: When using separate wires as the power cord, please secure separate wires in the control box panel using tie wraps to hold all wires in place.

1. Remove the control cover from the unit by loosening the screw.
Connect the wires to the terminals on the control board individually as the following.
2. Secure the cable onto the control board.
3. Re-attach the cover control to the original position using the screws.

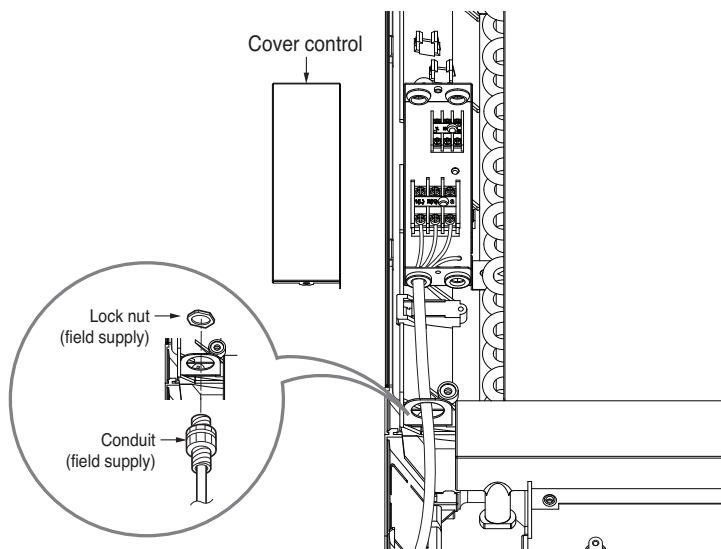
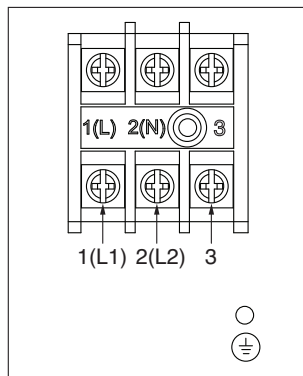

NOTICE :

1. Use connection cable NRTL(UL, ETL, CAS...) listed and stranded copper(4) THHN conductors, sunlight (UV) resistant ROHS compliant PVC jacket 600V direct burial listed, approved for wet conditions. Temperature rated for $-20^{\circ}\text{C}(-4^{\circ}\text{F})$ to $90^{\circ}\text{C}(194^{\circ}\text{F})$. And this cable should be enclosed in conduit.

! WARNING:

- Be sure to comply with local and national codes while running the wire from the indoor unit to the outdoor unit(size of wire and wiring method, etc).
- Every wire must be connected firmly.
- No wire should be allowed to touch refrigerant tubing, the compressor or any moving parts.
- The communication wirings of air conditioner should be separate and isolated from external device's electric wiring such as computers, elevator, radio & Television broadcasting facilities, as well as medical imaging offices.



WARNING: Loose wiring may cause the terminal to overheat or result in unit malfunction. A fire hazard may also exist. Therefore, be sure all wiring is tightly connected.

When connecting each power wire to the corresponding terminal, follow instructions "How to connect wiring to the terminals" and fasten the wire tightly with the fixing screw of the terminal plate.

How to connect wiring to the terminals

■ For strand wiring

- (1) Cut the wire end with a wire cutter or wire-cutting pliers, then strip the insulation to expose the strand wiring about 10 mm (3/8").
- (2) Using a screwdriver, remove the terminal screw(s) on the terminal plate.
- (3) Using a round terminal fastener or pliers, securely clamp each stripped wire end with a round terminal.
- (4) Position the round terminal wire, and replace and tighten the terminal screw using a screwdriver.

Power supply cable

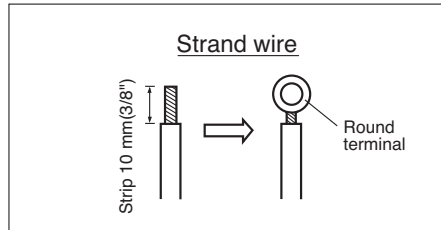

Connecting Cable

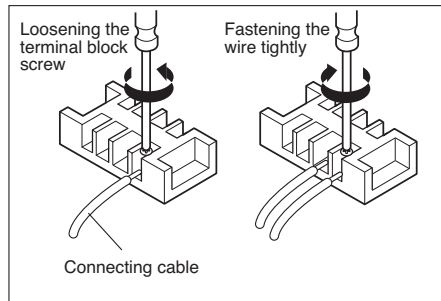

Checking the Drainage, Forming the Pipings and Long Pipe Setting

Checking the drainage

To check the drainage.

1. Pour a glass of water on the evaporator.
2. Ensure the water flows through the drain hose of the indoor unit without any leakage and goes out the drain exit.

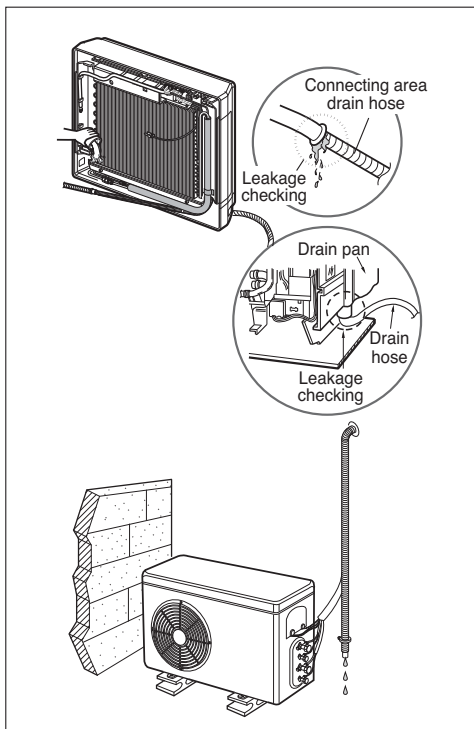

Drain piping

1. The drain hose should point downward for easy drain flow.

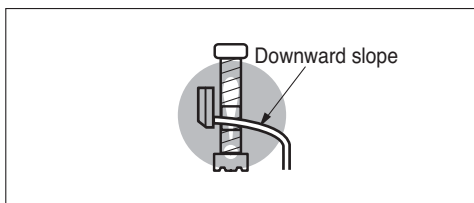

2. Do not make drain piping.

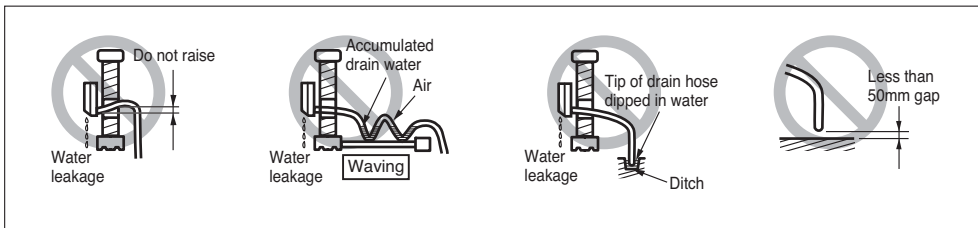

Panel Front Assembly

1. First, Check the side cover assembly exactly, Fix power cord in the bottom groove of cover side left.

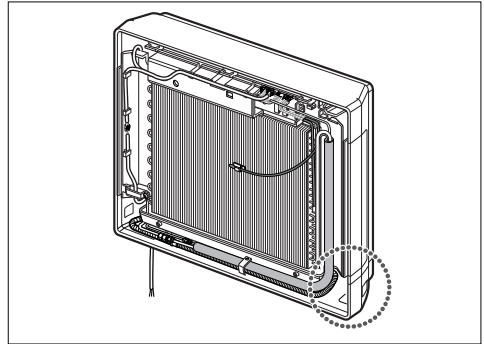

2. Assemble connecting lead wire with controller and first fix the upper part of panel front, then match the lower part of panel front

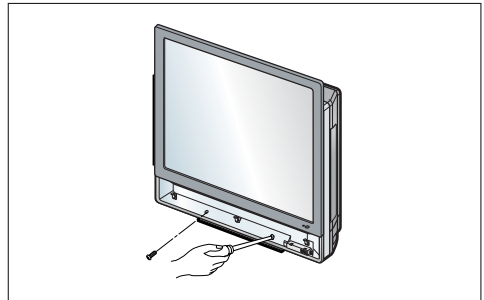
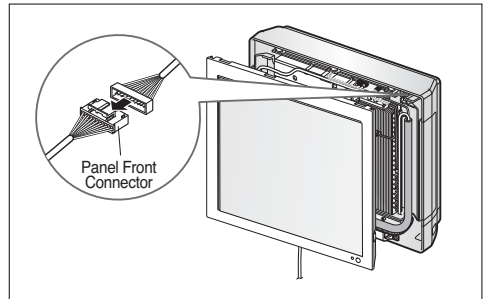

3. Suspend hook of front panel in the groove after contract lower of 2 screws.

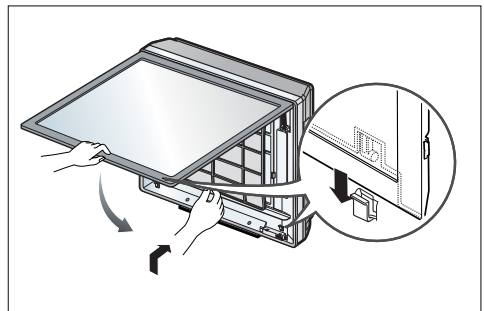



US	<ol style="list-style-type: none">1. Please call the installing contractor of your product, as warranty service will be provided by them.2. If you have service issues that have not been addressed by the contractor, please call 1-888-865-3026.
CANADA	Service call Number # : (888) LG Canada, (888) 542-2623