

Ion+® Connect

Digital Level Control Switch and Alarm
with Internal Cellular Module

OPERATION MANUAL

Dated: 11/09/2023

Document Name: Ion+ConnectGen2_OM

Page 1 of 16



INTRODUCTION

The Ion+ Connect is a residential sump/sewage ejector pump controller equipped with the Ion® level sensor and integrated cellular module for communicating with the Ion+ Connect app. The device will run one or two manual pumps up to 12 FLA, can sense up to 72" of water, has customizable start/stop/alarm levels, and provides alarm notifications via SMS text for alarms like high water, pump fail, power fail, and many more.

INPC20721 100-15D w/4G(NV)

INPC20723 100-20D w/4G(NV)

INPC20567 200-15D w/4G(NV)

WHAT'S IN THE BOX

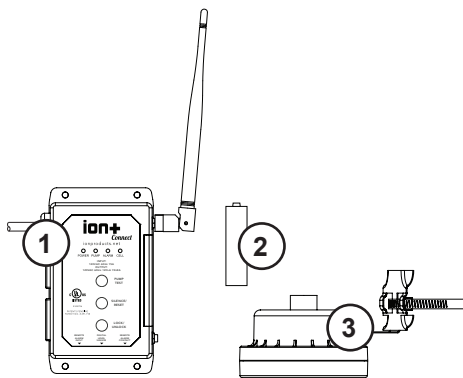

The Ion+ Connect comes with:

- 1. Ion+ Connect**
Pump Controller equipped with 10' 115 VAC 15A cord.

2. Rechargeable Lithium Ion Battery

Powers the Ion+ Connect in the even of power loss.

3. Ion Sensor with pipe clamp

Connects to Ion+ Connect to provide level signal.

FEATURES

The following illustration describes the physical features of your Ion+ Connect.

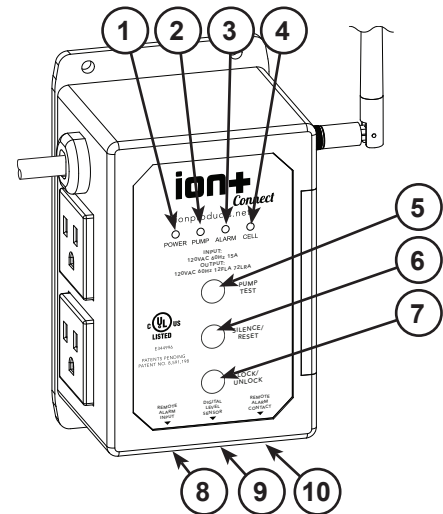

1. Power LED

Indicates the power status of unit.
Refer to the LED section for details.

2. Pump LED

Indicates the pump status.
Refer to the LED section for details.

3. Alarm LED

Indicates alarm status.
Refer to the LED section for details.

4. Cellular LED

Indicates cellular connectivity status.
Refer to the LED section for details.

5. Pump Test

Hold down the button until the device beeps to manually run pump(s).

6. Silence / Reset

Momentarily push for Alarm Silence.
Hold to reset unit.

Ion+® Connect

Digital Level Control Switch and Alarm
with Internal Cellular Module

OPERATION MANUAL

Dated: 11/09/2023

Document Name: Ion+ConnectGen2_OM

Page 2 of 16

7. Lock / Unlock

Press and hold until the unit beeps twice to unlock it.

8. Remote Alarm Input

Aux alarm input connection via 6P2C (RJ11) jack (must be powered).

9. Digital Water Level Sensor

Connection for Ion Sensor.

10. Remote Alarm Contact (Output)

Normally closed, dry contacts via 6P2C (RJ11) jack.

INSTALLATION



WARNING: Do not plug in the device until instructed.



WARNING: Do not install the lithium ion battery in the device until instructed.



CAUTION: The device must be allowed to reach room temperature or you run the risk of the device alarming once it's plugged in. Your Ion+ Connect is equipped with a temperature sensor. If the device is too hot or too cold based on the factory settings (over 110° F or under 45° F) the temperature sensor will alarm. If your Ion+ Connect alarms when it is plugged in, please see **Troubleshooting, Page 9**.

NOTE: IF YOU ARE INSTALLING THE ION+ CONNECT TO AN EXISTING SUMPRO MODEL 75, PLEASE CONTACT MANUFACTURER FIRST.

1. Install Ion+ Connect and Ion Sensor

- Mount the Ion+ Connect unit to wall with appropriate screws (not included).
- Determine the preferred pipe bracket mounting orientation for the Ion sensor (**See Figure B, page 2**).
- Mount the bracket to the Ion sensor with the screw already provided in the Ion sensor (**See Figure C, page 2**).
- Mount the hose clamp with attached sensor around the discharge pipe at the predetermined level. The sensor cable should remain outside of the hose clamp (**See Figure D, page 2**). Tighten the hose clamp.

FIGURE A

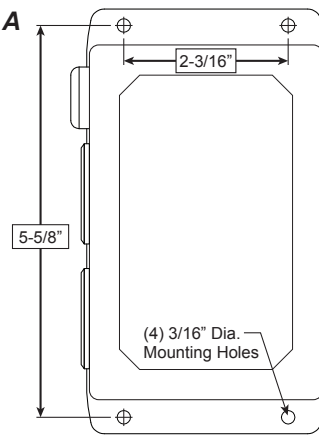

FIGURE B

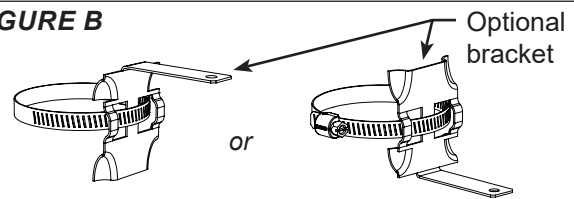

FIGURE C

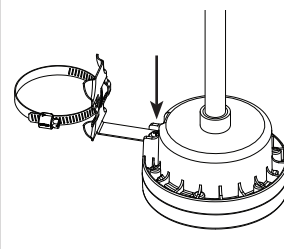
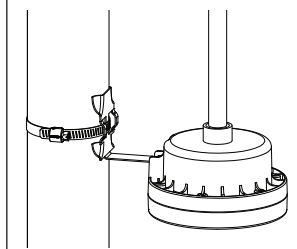

FIGURE D



- Pull the pump power cord and the Ion sensor cord through pit lid.
- If you have a simplex pump system, plug your pump into the top outlet on the left side of the Ion+ Connect. If you have a duplex system, plug the second pump into the bottom outlet on the Ion+ Connect.
- Plug the Ion sensor into the jack on the bottom labeled "Digital Level Sensor".

Note: The included Ion digital water level sensor has a 72" range. The range of the sensor is the maximum distance between the pump on and off levels. The off level is approximately at the bracket mounting screw of the sensor.

Ion+® Connect

Digital Level Control Switch and Alarm
with Internal Cellular Module

OPERATION MANUAL

Dated: 11/09/2023

Document Name: Ion+ConnectGen2_OM

Page 3 of 16



CAUTION: The bottom of sensor should not be mounted lower than the suction inlet of the pump. When installing the Ion sensor with the pipe mounting bracket, be sure not to set the sensor too low (below the inlet of the pump) or too high (allowing water to re-enter the inlet drain tile pipe) on the pump discharge pipe. The Ion sensor must be installed above the inlet of the pump to prevent airlocking as shown in the installation diagram (See **Figure E, Page 3**).

To prevent flooding do not set the on point of the pump higher than the top of the basin. This setting is configured in the Ion+ Connect app.

NOTE: If you purchased a pump with the Ion sensor already mounted to the pump (See **Figure F, Page 3**) and the installation requires the sensor be mounted to the pipe. You can purchase the pipe-mount bracket separately, PN: IN-SPB1-1.



WARNING: As a reminder, do not install the lithium ion battery in the device until instructed.

2. Power On

Plug the Ion+ Connect into a dedicated AC outlet. Alternately, if you have a battery backup system, plug the Ion+ Connect into the back of the inverter.

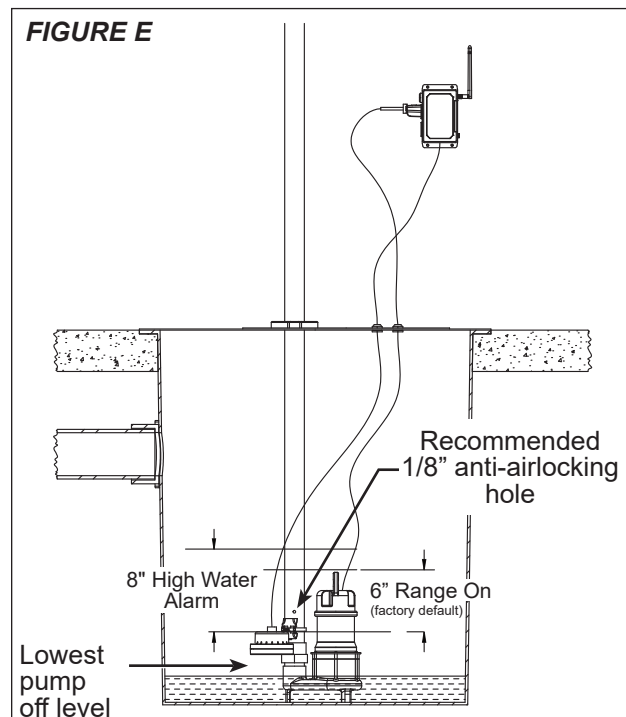
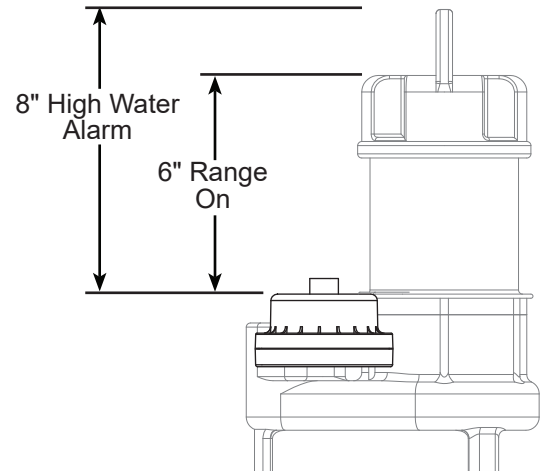

FIGURE F

Factory default settings
User adjustable up to 72"



3. Install Lithium Ion Battery

The Ion+ Connect comes with a rechargeable lithium ion battery to provide backup power in times of power loss. In order to continue to send out alarm notifications and sound the alarms in times of power loss, this must be installed. **Note:** This battery will not run your pump.

- The battery should be installed while the LEDs on the front of the Ion+ Connect are still flashing (about 5 seconds).
- Remove the slide cover on right edge of unit.
- Install battery (See **Figure G, Page 3**), observing proper orientation/polarity (positive battery terminal/button toward top).
- Reinstall the battery cover.

FIGURE G

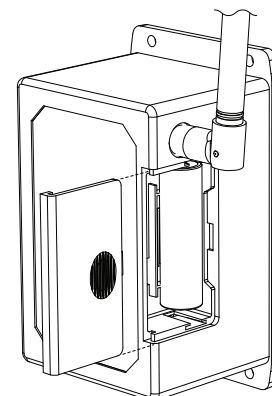

Ion+® Connect

Digital Level Control Switch and Alarm
with Internal Cellular Module

OPERATION MANUAL

Dated: 11/09/2023

Document Name: Ion+ConnectGen2_OM

Page 4 of 16

ACTIVATING YOUR ION+ CONNECT

Adding a Device to Your Account

1. Download the Ion+ Connect app from the Apple app store or the Google Play store.

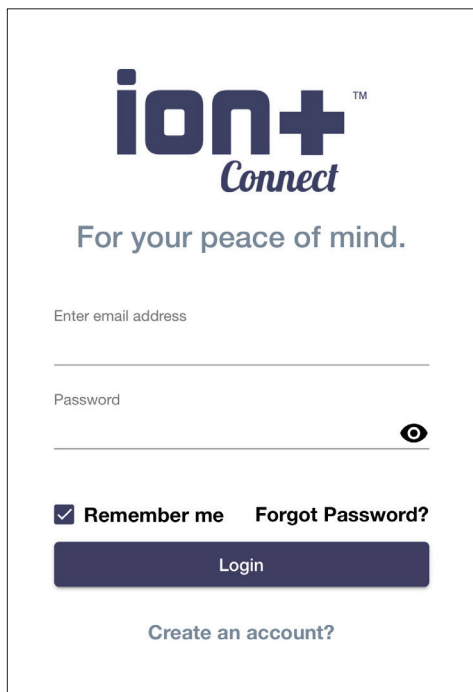

2. Alternately, visit app.ion.cloud for the web-based app if not using an Apple or Android device.
3. Once you have created an account and logged in, tap the Add Device button.

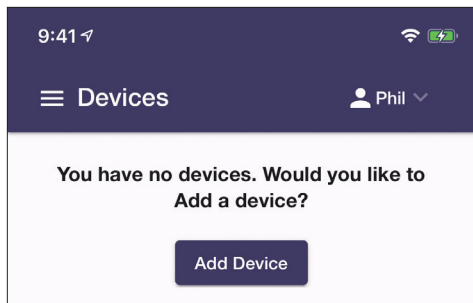

4. Next, tap the Scan QR Code button, and scan the QR code on the top of your Ion+ Connect (See Figure H, page 4). Note: If using the web-based app, you will need to manually enter the digits to the left of the QR code.

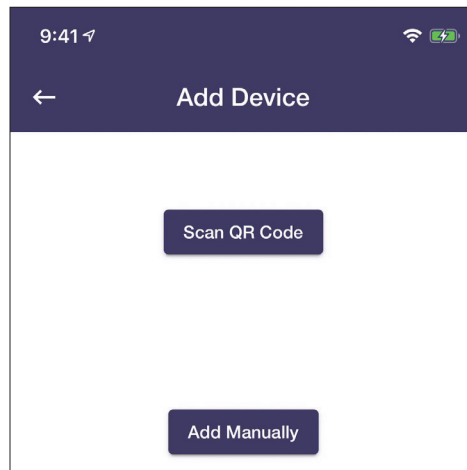
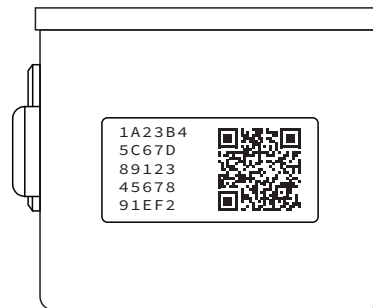
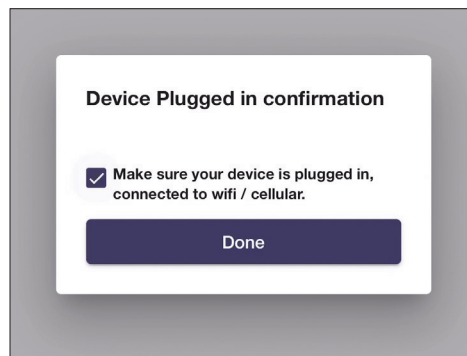

FIGURE H



5. Tap the checkbox to confirm your device is plugged in and tap done.



Ion+® Connect

Digital Level Control Switch and Alarm
with Internal Cellular Module

OPERATION MANUAL

Dated: 11/09/2023

Document Name: Ion+ConnectGen2_OM

Page 5 of 16

Activating the Ion+ Connect

1. Here you will see the cellular plan selection screen. Select your desired plan, confirm your renewal options, and enter your payment details.

Plan Selection

Please select your desired billing plan.

Verizon Cell to Cloud - \$48/Year
Cloud plan including Ion Connect portal access and alarm notifications. Typically, good for applications with less than 800 pump duty cycles a month.

Verizon Cell to Cloud - \$84/Year
Cloud plan including Ion Connect portal access and alarm notifications. Typically, good for applications with less than 1600 pump duty cycles a month.

Verizon Cell to Cloud - \$168/Year
Cloud plan including Ion Connect portal access and alarm notifications. Typically, good for applications with more than 3200 pump duty cycles a month.

Set Up Auto Billing

Yes, automatically renew my account yearly

No, I will manually renew my account yearly

Zip
60446

Phone Number
(81

Payment Processing...

Payment successfully completed

Next

2. Once payment is verified, the app will start the process of activating your device. This may take several minutes; once complete, your device is activated and setup can commence.

VZW Activation is in progress. Sit back & relax. It will take around 2-3 minutes.

- ✓ Activation request sent
- ✓ Activation request successful
- ✓ Checking line status
- ✓ Activation complete.

VZW activation successfully completed, Please click next

Next

Completing Device Setup

1. The Ion+ Connect will now connect to the cloud, a process which may take several minutes. You will notice the cell LED change from solid amber to solid green once this process is complete. Tap next.

Connecting device to cloud is in progress. Sit back & relax. It will take around 5-10 minutes.

- ✓ Waiting for device to check in
- ✓ Device has checked in
- ✓ Device connected to Cloud

Connecting cloud services successfully completed, Please click next

Next

Ion+® Connect

Digital Level Control Switch and Alarm
with Internal Cellular Module

OPERATION MANUAL

Dated: 11/09/2023

Document Name: Ion+ConnectGen2_OM

Page 6 of 16

2. Allow the device to synchronize data, and tap next.

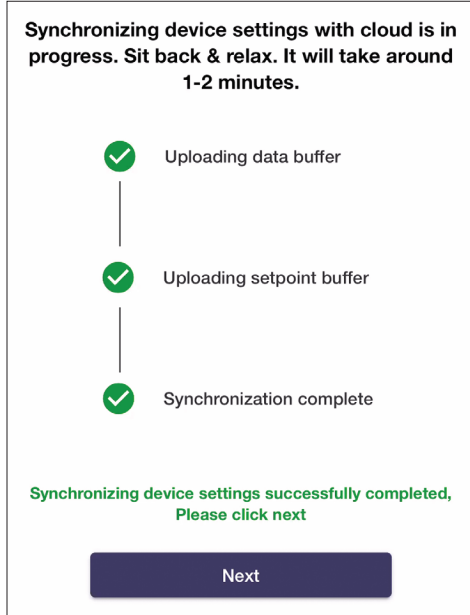

3. Choose basic or advanced setup and proceed through the setup options. These settings can be changed at any time once setup is completed.

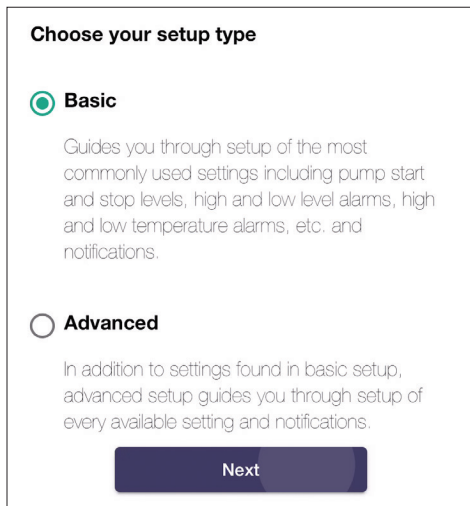

4. On the recipient list screen, you will already be added as a recipient based on the information you entered when you created your account. You can add additional recipients now or at a later time.

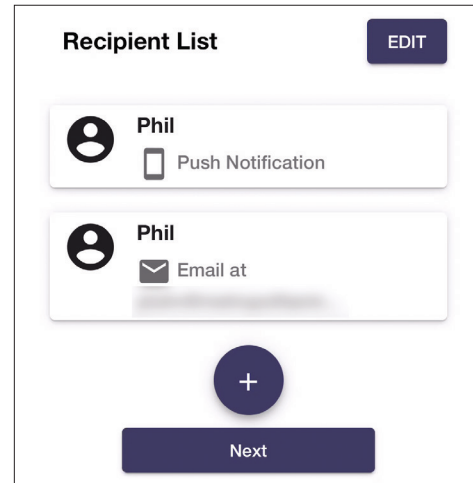

5. To complete setup, you can test run your pumps. Tap submit to complete the setup process.

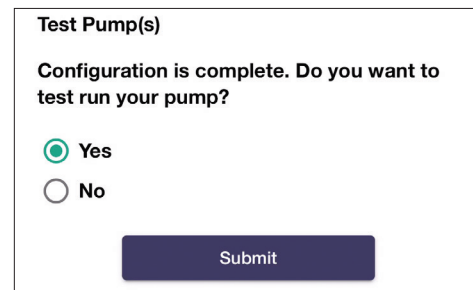

6. You will now see your Ion+ Connect in the list of devices. Tap the device to go to the device overview screen.

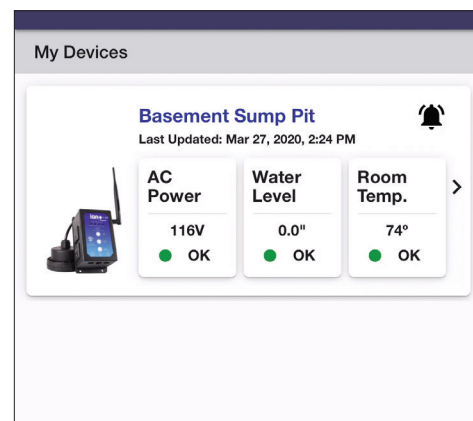

Ion+® Connect

Digital Level Control Switch and Alarm
with Internal Cellular Module

OPERATION MANUAL

Dated: 11/09/2023

Document Name: Ion+ConnectGen2_OM

Page 7 of 16

7. Installation and basic setup of your Ion+ Connect is now complete.

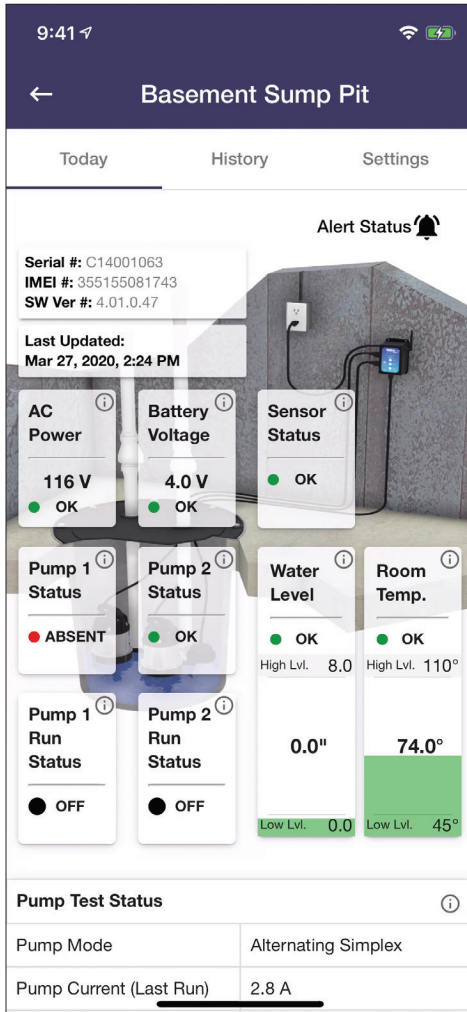

TESTING YOUR ION+ CONNECT

1. Test Your Pump

You can test your Ion+ Connect at any time by pressing the “Pump Test” button.

- a. Holding Pump Test will manually run pump.
- b. Holding Pump Test for 3 seconds will send a notification to those on the list.

2. Test Your Ion Sensor

- a. Fill the sump pit with water.
- b. Confirm the water is pumped out of the pit. No alarms or text messages should be initiated.

3. Test Your Controller Backup Battery

- a. Unplug the AC power adapter from the 120 VAC outlet.
- b. Once the Ion+ Connect detects that power was lost, each recipient you configured will receive a notification, and the power LED will blink amber.
- c. Plug the AC power adapter back into the 120 VAC outlet.

NOTE: The backup battery requires approximately 6 hours to fully recharge. The battery has a lifespan of up to 3 years and should be replaced regularly. The battery's voltage/condition is visible in the Ion+ Connect app.

Testing is Complete

- a. Your Ion+ Connect has been tested and is working properly.
- b. You should periodically perform these tests on the Ion+ Connect to ensure you are always protected.

ANTENNA EXTENDER

If the location of your sump pit has a weak cellular signal, you can use the optional antenna extender to improve your signal. Use the included adhesive pads and cable ties to route the cable to a location with better cellular reception. Attach the end of the antenna extender's cable to the Ion+ Connect, and mount the antenna extender to the wall with the attached bracket (**Figure I, page 7**).

FIGURE I

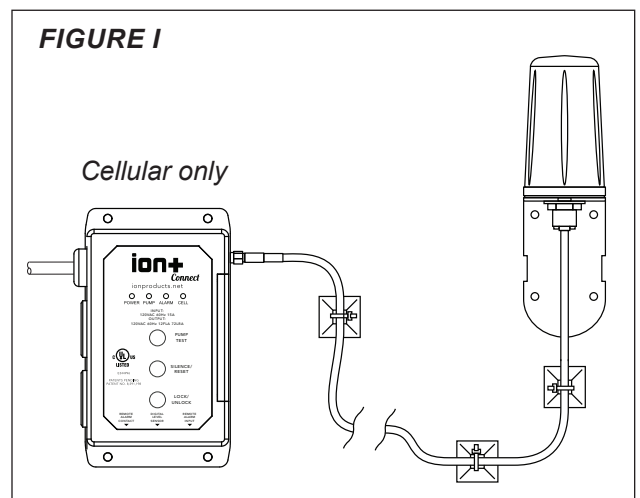

Ion+® Connect

Digital Level Control Switch and Alarm
with Internal Cellular Module

OPERATION MANUAL

Dated: 11/09/2023

Document Name: Ion+ConnectGen2_OM

Page 8 of 16

FACTORY SETTINGS

Your Ion+ Connect is shipped with factory recommended settings. If you decide not to change any settings your Ion+ Connect will function as follows:

High Level: 8"

Pump Start: 6"

Pump Stop: 2"

Lag Pump Start: 8"

Lead Pump Start: 6"

Lag Pump Stop: 2"

Lead Pump Stop: 2"

Low Level: 0"

Temperature High: 110° F

Temperature Low: 45° F

MODE EXPLANATIONS

WARNING: Changing these settings incorrectly may adversely affect pumping operation. If unsure about the settings, consult the website FAQs and videos or contact technical support.

The controller has a menu of user-configurable settings that may be altered if an unusual pump installation requires it; normally, these settings do not need to be changed. The individual settings are described below and, once saved, will be retained in the event of a complete power failure.

Controller's Operating Mode

The Controller's Operating Mode can be set to one of four modes. "Duplex Similar" means the controller will run one or two pumps together as required. "Duplex Mixed" means the controller will run one or two dissimilar pumps (that is, each drawing much different current) as required. "Simplex Non-alternating" means there is only one pump installed and it is plugged into pump outlet #1. This allows a pump to be installed that uses the entire current available to the controller by the electrical outlet on the wall. "Simplex Alternating" means there are two pumps installed, but they will never run simultaneously. This, too, allows each pump to use the entire current available to the controller by the electrical outlet on the wall since

the pumps will never be run together. The default is Duplex Alternating mode.

Lag Start Level (2 pump operation only)

The Lag Start Level is the number of inches *above* the Setpoint that was configured in the Setup section where the *second* pump will turn on. The default is 4 inches.

Excess Run Time

The Excess Run Time is the number of minutes that a pump can run continuously before an alarm is initiated. This alarm feature can be turned off by setting it to zero. The default is 5 minutes.

Emergency Run Time

The Emergency Run Time is the minimum number of seconds a pump(s) will run when water has reached the HIGH LEVEL SENSOR. The default is 10 seconds.

OPERATION

The controller will turn one pump on whenever the water level rises above the Setpoint that was configured in the Setup section. If the water continues to rise a few inches above that height (as configured in the Menu), a second pump will be turned on, if it is present and the controller is set to run in duplex mode (see the Menu section). Any running pump will be turned off after the water level is pumped down to the middle of the DIGITAL LEVEL SENSOR.

Note: The controller will operate based on what it is set to as described in the Menu section, under "Controller's Operating Mode".

Under any of the following conditions, the controller will enter a state of alarm:

- A pump failure has been detected
- The water level reaches the HIGH LEVEL SENSOR
- A water level sensor has failed
- A pump has been continuously running but the water level remains above the DIGITAL LEVEL SENSOR for an extended period of time (as determined by the Menu setting)

Ion+® Connect

Digital Level Control Switch and Alarm
with Internal Cellular Module

OPERATION MANUAL

Dated: 11/09/2023

Document Name: Ion+ConnectGen2_OM

Page 9 of 16

Once in an alarm state, the controller will notify the user that there may be trouble by:

- Initiating audible and visual cues
- Breaking (electrically opening) the remote alarm contacts which can be connected to another alarming device, allowing it to inform the user remotely (these contacts are normally closed)
- Communicating the alarm based on notification settings in the app.

PUMP FAULT DESCRIPTION

The controller determines pump condition via its built-in electrical current sensor. Whenever a pump draws abnormal current, the controller enters a state of alarm telling the user that pump service is needed. The following charts (See Figures 2 through 5, Page 13-14) describe these conditions. An "X" means behavior occurs for a particular pump state.

SPECIFICATIONS

Remote Alarm Contacts:	Normally Closed, 30 VAC/DC @ 1 A
Temperature Range:	-20 °C to 60 °C (-4 °F to 140 °F)
Audible Alarm:	> 90 dB at 2 feet
Enclosure:	NEMA-1 Polycarbonate
Dimensions (controller):	6.125" x 3.25" x 3"
Dimensions (sensor):	4.62" x 4.62", mounting straps: 5.25" x 3.50"
Mounting:	Up to #10 screws

Maximum Output	
INPC20721 100-15D	120 VAC @ 12 A
INPC20610 100-15D	120 VAC @ 12 A
INPC20723 100-20D	120 VAC @ 16 A
INPC20615 100-20D	120 VAC @ 16 A
INPC20567 200-15D	200-240 VAC @ 12 A
INPC20619 200-15D	200-240 VAC @ 12 A

See settings tab in app to change advanced settings - each setting has a description.

TROUBLESHOOTING

Your Ion+ Connect alarms as soon as you plug it in.

1. Open the Ion+ Connect app and make note of the device's temperature reading.
2. In the device settings screen, change the temperature setpoint so that the temperature reading is within range. This can be changed at a later time to a different temperature.

Ion+ Connect Does Not Turn On Pump

1. Test the pump without the Ion+ Connect
 - a. Plug the pump directly into the wall outlet, without plugging it into the Ion+ Connect.
 - b. If pump still does not run, see the troubleshooting section in the pump manual.
 - c. If the pump does run, continue to the next step.
2. Test the Ion+ Connect with the pump
 - a. Plug the pump into the Ion+ Connect and plug the Ion sensor plug into the Ion+ Connect.
 - b. Push up on the sensing plate through the center hole on the underside of the sensor. Note that, being an electronic sensor, you will not hear a clicking sound. If it is working, you will see an orange LED come on, along with the green LED.
 - c. If the pump does not turn on, the sensor may have to be replaced.
 - d. If the pump does turn on, continue to the next step.
3. Verify the pump start/stop settings for the sensor
 - a. For a pipe-mounted sensor, see **Page 3, Installation Drawing** to verify that the On level is appropriate for your basin.
 - i. Lower the sensor on the pipe so the On level is at a point within the basin,

Ion+® Connect

Digital Level Control Switch and Alarm
with Internal Cellular Module

OPERATION MANUAL

Dated: 11/09/2023

Document Name: Ion+ConnectGen2_OM

Page 10 of 16

insuring that the Off level does not fall below the minimum level shown in the Installation Drawing.

- ii. If the On level is still too high, adjust the pump start level via text commands.
- b. For a pump-mounted sensor, see **Page 3, Figure F** to verify that the On level is appropriate for your basin.
 - i. If the On level is too high, adjust the pump start level via text commands.

Ion+ Connect Does Not Turn Off Pump

1. Unplug the pump from the Ion+ Connect and then unplug the Ion+ Connect.
2. Plug the pump back into the Ion+ Connect and plug the Ion sensor back into the Ion+ Connect.
 - a. If the pump does not turn on right away, and the water level is not at the On level, let the pump go through an On / Off cycle a few times to insure that the sensor is functioning properly. The basin may need to be filled with water using a garden hose or bucket.
 - b. If the pump turns on right away, and the water level is not at the On level, adjust the level via text or move the sensor higher on the pipe.

To Test Ion+ Connect Alarm Mode

1. Applying constant pressure, push on sensing plate past the turn on point. Once the orange LED comes on, continue pushing until you see the orange LED flash. The red LED will turn on next and then the audio alarm will sound.
2. If you can not push the sensing plate hard enough to activate high water alarm mode, the sensor will need to be replaced.

Note: When the Ion+ Connect goes into alarm mode, the orange LED will flash. All LEDs will go blank and it will then go into alarm mode.

The controller keeps reporting a water sensor failure.

Make sure the sensor is securely plugged into its

jack in the controller box (see Installation section).

Pump won't turn off even though pit is empty.

The digital level sensor must be mounted above all pump intakes.

Error Reporting, Troubleshooting and Support

For technical support and troubleshooting tips please call 815-886-9200 or visit our website at ionproducts.net. If you are unable to solve your issue using our online support, email info@ionproducts.net with your contact information and a description of the problem, and a support representative will call you within one business day.

Additional Information and Support

For additional information or more detailed instructions on how to use your Ion+ Connect system, as well as installation and setup videos, please visit us on the web at ionproducts.net.

WARRANTY IS VOID IF...

1. Using an extension cord.
2. Power cord has been cut or the grounding prong removed or using an adapter fitting.
3. The switch has been disassembled or tampered with.
4. Any tags or labels have been removed.

Ion+® Connect

Digital Level Control Switch and Alarm
with Internal Cellular Module

OPERATION MANUAL

Dated: 11/09/2023

Document Name: Ion+ConnectGen2_OM

Page 11 of 16

Figure 2: Duplex Operation – 2 pumps with similar current draw installed; both intended to run simultaneously when required.

Number of Pumps Running	Current	Duplex Pumping Locked Out*	Duplex Pumping Forced Off†	Pump		Alternate To Next Pump	Beep	Open Remote Alarm Contacts	LCD Updates
				Locked Out*	Bad‡				
2	Extreme	X	X				X	X	X
	High, 3 Times	X	X				X	X	X
	High		X					X	X
	Low						X	X	X
1	Critical	N/A	N/A	X		X	X	X	X
	Extreme, 3 Times	N/A	N/A		X	X	X	X	X
	Extreme	N/A	N/A			X		X	X
	High, 3 Times	N/A	N/A					X	X
	High	N/A	N/A					X	X
	Low	N/A	N/A			X	X	X	X

Figure 3: Duplex Mixed Operation – 2 pumps with dissimilar current draws installed; both intended to run simultaneously when required.

Number of Pumps Running	Current	Duplex Pumping Locked Out*	Duplex Pumping Forced Off†	Pump		Alternate To Next Pump	Beep	Open Remote Alarm Contacts	LCD Updates
				Locked Out*	Bad‡				
2	Extreme	X	X				X	X	X
	High, 3 Times	X	X				X	X	X
	High		X					X	X
	Low						X	X	X
1	Critical	N/A	N/A	X		X	X	X	X
	High, 3 Times	N/A	N/A	X			X	X	X
	High	N/A	N/A		X			X	X
	Low	N/A	N/A			X	X	X	X

Figure 4: Alternating, Simplex Operation – 2 pumps installed, only one pump intended to run at one time.

Number of Pumps Running	Current	Pump		Alternate To Next Pump	Beep	Open Remote Alarm Contacts	LCD Updates
		Locked Out*	Bad‡				
1	Extreme	X		X	X	X	X
	High, 3 Times	X		X	X	X	X
	High		X	X	X	X	X
	Low			X	X	X	X

Figure 5: Non-Alternating, Simplex Operation – 1 pump installed, only pump 1 will run. Pump 2 is disabled.

Number of Pumps Running	Current	Pump		Beep	Open Remote Alarm Contacts	LCD Updates
		Locked Out*	Bad†			
1	Extreme	X		X	X	X
	High, 3 Times	X		X	X	X
	High		X	X	X	X
	Low			X	X	X

* Duplex Pump Mode or pump is permanently locked out from running until controller is reset.

† Running two pumps simultaneously is temporarily disabled; that is, one pump is turned off.

‡ Pump is only run as a lag (secondary) pump.

LED EXPLANATIONS

Power LED

Condition	
Normal	
battery ok, AC ok	Solid GREEN
battery charging, AC ok	Blinking GREEN (1s on, 1s off)
Triggered alarm	
Loss of power	Blinking AMBER (0.1s on, 0.9s off)
battery low	Alternate blinking AMBER and RED (RED ON, GREEN 0.5s on, 1.5s off)
battery critically low	Blinking RED (0.1s on, 0.9s off)

Pump LED

Condition	
Normal	
pump off	Off
pump on	Solid AMBER
Triggered alarm	
no pump	Blinking AMBER (0.5s on, 0.5s off)
pump fail	Blinking AMBER (1s on, 1s off)

Alarm LED

Condition	
Normal	
no alarm	Off
Triggered alarm	
alarm	Fast-blinking RED (0.3s on, 0.3s off) w/ Buzzer
silence	Slow-blinking RED (1s on, 1s off) w/o Buzzer

Buzzer interval same as fast-blinking RED (0.3s on, 0.3s off)

Ion+® Connect

Digital Level Control Switch and Alarm
with Internal Cellular Module

OPERATION MANUAL

Dated: 11/09/2023

Document Name: Ion+ConnectGen2_OM

Page 13 of 16

Cell LED

LED Status	Condition
Solid AMBER	Device is connecting to the cellular network
Fast Blinking GREEN (0.3s on, 0.3s off)	Successfully connected to the cellular network, opening socket connection
Fast Blinking AMBER (0.3s on, 0.3s off)	Communication with the cloud initiated
Slow Blinking AMBER (1.5s on, 1.5s off)	Communication with the cloud in progress
Solid GREEN	Cellular setup complete

OPTIONAL EXTERNAL CONNECTIONS

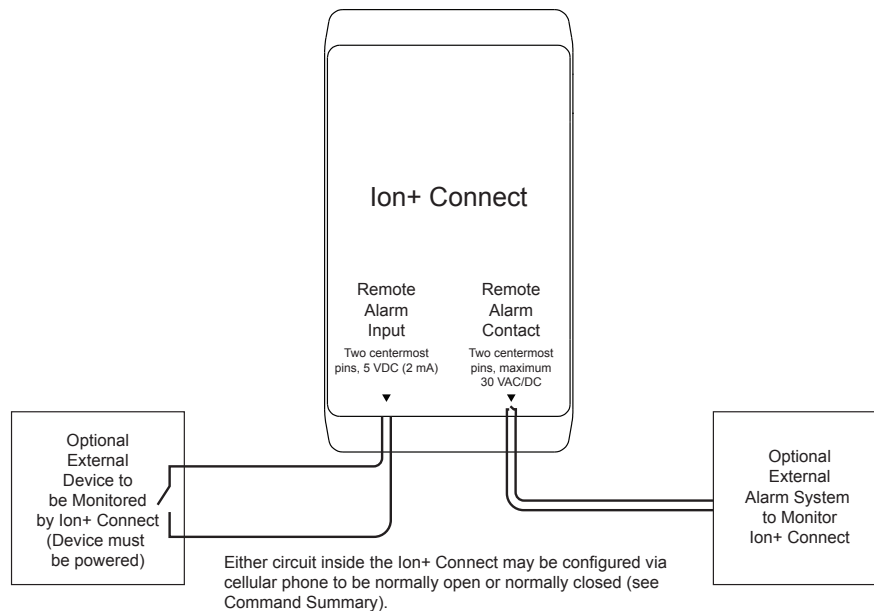

INFORMATION TO USER

Changes or modifications not expressly approved by Metropolitan Industries will void the user's authority to operate the equipment.

NOTE: This equipment has been tested and found to comply with the limits for a Class A digital device, pursuant to part 15 of the FCC Rules. These limits are designed to provide reasonable protection against harmful interference when the equipment is operated in a commercial environment. This equipment generates, uses, and can radiate radio frequency energy and, if not installed and used in accordance with the instruction manual, may cause harmful interference to radio communications. Operation of this equipment in a residential area is likely to cause harmful interference in which case the user will be required to correct the interference at his own expense.

Ion+® Connect

Digital Level Control Switch and Alarm
with Internal Cellular Module

OPERATION MANUAL

Dated: 11/09/2023

Document Name: Ion+ConnectGen2_OM

Page 16 of 16

1 Year Residential Warranty

1. Coverage and Term. Metropolitan Industries, Inc. (“**Metropolitan**”) warrants to the original purchaser (the “Buyer”) of each Ion Technologies product (the “product”), that any part thereof which proves to be defective in material or workmanship within one (1) year from date of manufacture, will be replaced at no charge with a new or remanufactured part, F.O.B. factory. Buyer shall be responsible for all freight charges and all costs of field labor or other charges incurred in the removal and/or reinstallation of any product, part or component thereof.
2. Exclusions. **THE WARRANTY IS SUBJECT TO THE FOLLOWING CONDITIONS AND EXCLUSIONS:**
 - (a) The Warranty excludes products or workmanship which becomes defective as a result of: (i) earthquake, fire, storms, the elements or any other acts of God; (ii) normal wear and tear from use; (iii) accident, misuse, abuse or neglect; (iv) modifications made by Buyer or any third party, other than **Metropolitan**; and (v) Buyer’s failure to properly install, maintain, service and/or operate the product under normal conditions and according to manufacturer’s instructions.
 - (b) **Metropolitan** shall not be responsible for, and the Warranty shall not cover, extended damage which occurs because of Buyer’s failure to notify **Metropolitan** promptly in writing of apparent defects.
 - (c) Any part or component designated as manufactured by anyone other than **Metropolitan** shall be covered only by the express warranty of the manufacturer thereof.
 - (d) The Warranty shall lapse upon Buyer’s failure to fully comply with the terms and conditions of its contract with **Metropolitan**, including Buyer’s failure to pay the purchase price for the product or any portion thereof. Buyer’s subsequent compliance with the terms and conditions of any such contract, will not cause the term of the Warranty to extend beyond the time period set forth above.
 - (e) No actions taken by **Metropolitan** to correct a defect in a product shall extend the Warranty beyond the period set forth above. **Metropolitan** shall not be obligated to remedy any defect, where otherwise required pursuant to the Warranty unless and until Buyer notifies **Metropolitan** in writing of the defect and then only if such notification is made prior to the expiration of the period set forth above.
3. Process of Claims and Repairs. **Metropolitan** agrees that if the product or any part or component thereof shall fail to conform to the terms of this Warranty, **Metropolitan** shall replace such nonconforming product, part or component at the original point of delivery and furnish instruction for its disposition. Any transportation charges involved in such disposition and all costs of field labor or other charges incurred in the removal and/or reinstallation of any product, part or component thereof shall be the responsibility of Buyer.
4. Limitation on Liability. Notwithstanding any provision to the contrary, **Metropolitan’s** entire liability under this Warranty shall not in the aggregate exceed, and Buyer’s exclusive and sole remedies are, to the extent permitted by law, shall be to secure replacement of the defective product. **UNDER NO CIRCUMSTANCES SHALL METROPOLITAN BE LIABLE UNDER THE WARRANTY FOR ANY INDIRECT, PUNITIVE, SPECIAL, EXEMPLARY, CONSEQUENTIAL OR INCIDENTAL DAMAGES (INCLUDING LOST PROFITS, REVENUE, USE OR ECONOMIC ADVANTAGE).**
5. Express Waiver of Any Other Warranties. **THE EXPRESS WARRANTY SET FORTH IN THIS WRITTEN WARRANTY IS THE ONLY WARRANTY MADE BY METROPOLITAN, OR ANY OTHER PARTY, IN CONNECTION WITH ANY PRODUCT PURCHASED FROM METROPOLITAN. NEITHER METROPOLITAN, NOR ANY OTHER PARTY, MAKES ANY OTHER EXPRESS OR IMPLIED WARRANTY WHICH IS NOT SET FORTH HEREIN, AND METROPOLITAN HEREBY DISCLAIMS AND BUYER HEREBY WAIVES ALL IMPLIED WARRANTIES, INCLUDING THE IMPLIED WARRANTY OF MERCHANTABILITY AND THE IMPLIED WARRANTY OF FITNESS FOR A PARTICULAR PURPOSE.**
6. Not Transferable. The Warranty may not be transferred and shall be void on the sale or other transfer of the product.
7. Products and Warranty Subject to Change. **Metropolitan** reserves the right to make revisions to its products and their specifications, and to revise this Warranty and related information without notice.