

GENERAC®



Powered by  Tank Utility

WiFi Tank Level Monitor
Installation Instructions

COMPATIBILITY

To install the Tank Utility remote level monitor, you will need the following:



A WiFi connection at your tank site



An Apple or Android smartphone or tablet



A propane tank with a Remote-Ready Dial

DIAL REPLACEMENT

Remote-Ready dials have a slot that a tank monitor can slide into. If you do not have a compatible dial, Tank Utility sells and supports the installation of replacement Remote-Ready Dials. For propane tanks, this upgrade can often be completed without depressurizing the tank. Professional installation by a delivered fuel professional is recommended.

WIFI

Tank Utility monitors use the 2.4 GHz frequency and cannot be connected to networks with a captive portal or firewalls or WEP security types. Please contact your internet service provider if you need assistance understanding the details of your network.

WATCH THE VIDEO

Before you start, watch the installation video at www.tankutility.com/generac-setup

CONTENTS

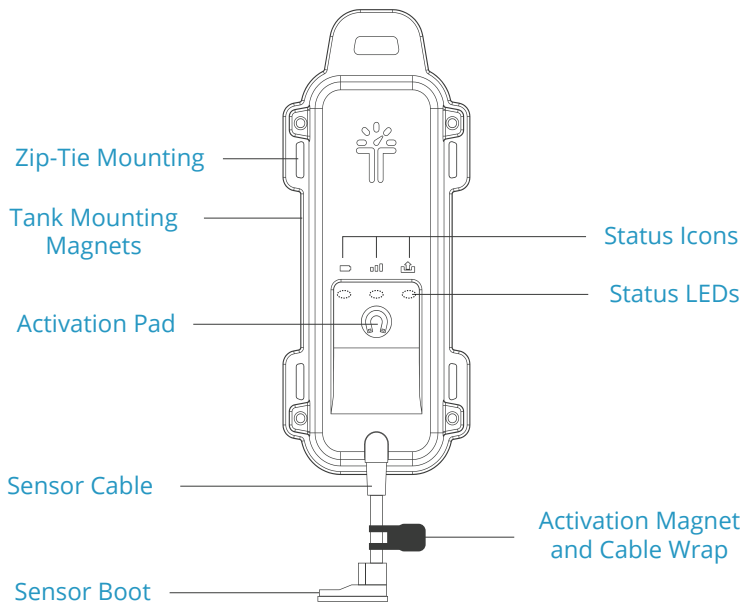

Tank Monitor



Self-Tapping Mounting Screws

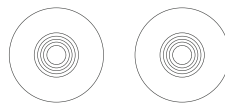

Mounting Washers

MONITOR SETUP

STEP 1: Attach The Sensor To Your Tank's Dial

If your Remote-Ready Dial has a black **dust cap**, you will first need to remove it by simultaneously pulling up on the tab while sliding the dust cap out of the dial.

If applicable, route the cable through the hole in the tank's collar or lid.

Slide the **sensor** into the slot in the dial until you feel it click.

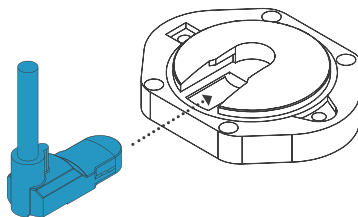
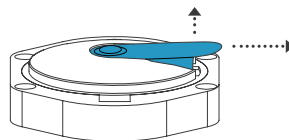

MONITOR SETUP

STEP 2: Get The Tank Utility Setup App

Go to www.tankutility.com/getapp to download the Tank Utility Setup App, or search for “Tank Utility Setup” on the Play Store or Apple Store.



Open the app, and select your monitor.



MONITOR SETUP

STEP 3: Turn Your Monitor On And Connect Your WiFi Network

Follow the instructions in the Setup App to hold the **activation magnet** (attached to the cable) to the **activation pad** (denoted by the magnet icon) on the monitor for 5 seconds, then remove when the middle LED turns purple.

Please refer to the “Troubleshooting” section of this guide if your monitor shows any red LEDs. ⚠

Enter your WiFi credentials. Continue to follow the instructions in the Tank Utility Setup App to connect your monitor to your WiFi network.

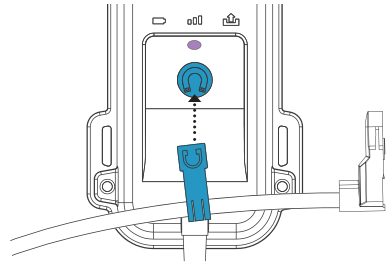

Hold the activation magnet to the activation pad until the middle LED turns purple.

MONITOR SETUP

STEP 4: Configure Your Device In The Tank Utility App

Download and open the Tank Utility monitoring app. You can also access the web app at app.tankutility.com



Enter the **8 digit ID number** of your monitor into the app. The ID number is listed on the back of the device.

Assign a name, address, and details about your propane tank to your monitor. These details will help us calculate your tank level and fuel usage accurately.

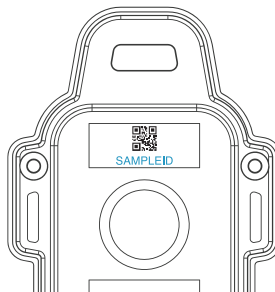

MONITOR SETUP

STEP 5 : Mount The Monitor

FOR ABOVE GROUND TANKS

The underside of the monitor has two protruding magnetic feet which can be used to mount the monitor on either the tank or the lid.

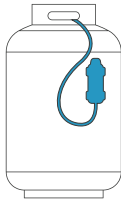

On **vertical tanks**, mount the monitor with the cable pointing downwards.

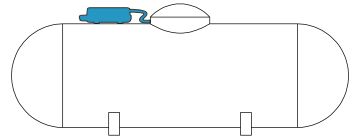

On **horizontal tanks**, mount the monitor on top of the tank.

NOTE: Do not place the tank monitor under a steel lid or inside the collar since this can prevent the monitor from connecting to the cellular network.

FOR BELOW GROUND TANKS

It is best to securely attach the monitor to the top of the lid. If the lid is not metal, use the included **self-tapping screws** to attach the **mounting washers** to the non-metal lid to provide a place for magnet mounting.

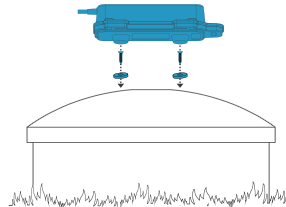

TROUBLESHOOTING SETUP ⚠️

When the monitor is prompted to send a reading each LED will blink in succession. Each LED will turn solid aqua blue when the corresponding step is completed. If a problem is encountered, the LED will turn red.



BATTERY VOLTAGE

The batteries need to be replaced.



NETWORK ACCESS

The monitor cannot connect to the Tank Utility server. This could be because of a poor WiFi signal or a network setting that blocks Tank Utility from accessing the internet.



READING CONFIRMATION

The monitor has not received a confirmation of a successful reading.

To Turn Off The Tank Monitor

This will prevent the monitor from sending additional readings. Hold the **activation magnet** over the **activation pad** for approximately 15 seconds until all 3 LEDs are red. Remove the **activation magnet** while all 3 LEDs are red.

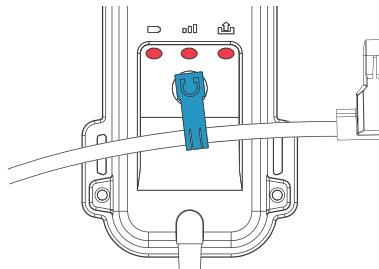

Need help?
855-436-8439
TankUtilitySupport@Generac.com

Prompt A Reading

The WiFi monitor sends a reading every 6 hours. To force a reading to be sent, hold the **activation magnet** to the **activation pad** for 3 seconds, and release when the LEDs flash aqua blue.

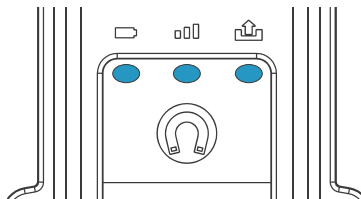

Hold activation magnet to pad until 3 LEDs flash aqua blue, then remove magnet.

Enter New WiFi Credentials

Open the Tank Utility Setup App, as described in step 2.2 of Monitor Setup (page 6 of this document).

Follow the instructions in the Setup App to hold the **activation magnet** to the **activation pad** on the monitor for up to 10 seconds and remove when the middle LED turns purple.

Follow the steps outlined in the Setup App to complete the setup process with new WiFi credentials.

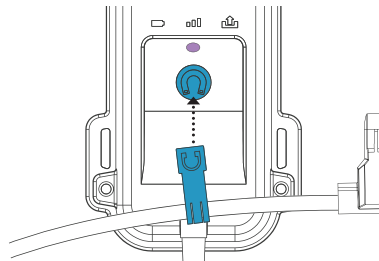

Hold the activation magnet to the activation pad until the middle LED turns purple.

Battery Replacement

To replace your batteries, remove the 4 screws from the tabs on the enclosure and remove the base. Batteries must be unused Energizer Ultimate Lithium L91. Using used batteries or a different model void the warranty. When closing the monitor, attach the base with screws fastened tightly, to 9 inch-pounds. Failure to tighten properly will void the warranty.

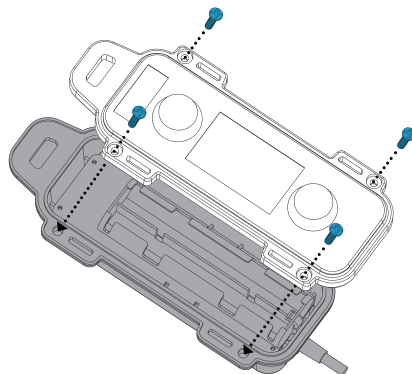
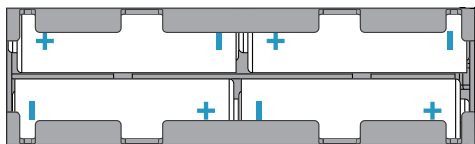

Need help?
855-436-8439
TankUtilitySupport@Generac.com