



**3/4" IMPACT WRENCH  
MODEL EGA130**

**OWNERS MANUAL**



[www.eaglecompressor.com](http://www.eaglecompressor.com)  
1-800-551-2406

---

# READ THE ENTIRE MANUAL BEFORE PUTTING THIS TOOL IN SERVICE

## Limited Air Tool Warranty

Wood Industries, Inc. warrants air tools of its own manufacture against defects in workmanship and materials under normal use and service for twelve(12) months from date of purchase by original purchaser. Parts are covered by this warranty for ninety(90) days from date of purchase.

The following expandable items are warranted against defects in workmanship and materials for ninety(90) days from date of purchase: sockets, screw driver bits and accessories, sanding and back-up pads, impact mechanism, chisels and their retainers, cutting and grinding accessories and any other expandable items not specifically mentioned.

Normal wear and tear, service or maintenance items such as O-rings, springs, gaskets, packing or seals, fluid needles and nozzles, motor vanes or blades, collets, chucks or any such item not specifically mentioned are covered for ninety(90) days from date of purchase warranty only.

Eagle will, at its sole discretion, repair or replace the tool or parts that have failed within the warranty period. If repairs are considered, they will be scheduled in the normal course of the workflow at its service centre.

Not covered under this warranty:

- Indirect or consequential loss or damage or expenses resulting from the failure or malfunction of this tool.
- Accidents or failures resulting from owners neglect, abuse or failure to operate and maintain the tool in accordance with the instructions provided in the owner's manual.
- Tampering, removal or alterations of safety devices will void this warranty.
- Blemishes or cosmetic defects which do not effect the tool's operation.
- Tools used industrially, commercially or in rental applications.

To claim warranty the owner/purchasers must provide proof of purchase and maintenance records, and when requested ship or deliver at owner/purchasers expense and cost to Eagle's factory or service centre



Wear hearing protection.  
Wear eye protection.  
Wear respiratory protection.

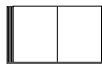

Read the instruction manual

---

# TABLE OF CONTENTS

---

Limited Warranty .....	2
Description.....	3
Inspection .....	3
Safety Instructions .....	3
Before Using This Air Tool .....	5
Operating Instructions .....	5
Troubleshooting.....	5
Parts Breakdown .....	6
Tool Specifications.....	7

---

## DESCRIPTION

---

Eagle Air tools are manufactured in accordance with our strict specifications and designed to be used in light duty professional or serious DIY applications. When used in accordance with warnings and instructions given in this manual, and when properly applied and maintained they should give you many years of productive and trouble free service.

This tool is NOT designed for professional, production or industrial use, when used in these applications its life expectancy will be significantly shortened and the warranty will be void.

---

## INSPECTION

---

Upon receipt of your new tool, carefully check for any shipping damage. If your new tool is damaged in shipping you need to file a claim with the carrier at once, and before contacting Eagle's customer service department.

Also carefully check to make sure all accessories (if included) are with the tool. Make sure any loose bolts, fittings etc. are tightened before you put this tool into service.

---

## SAFETY INSTRUCTIONS

---

You should operate this air tool only if you have read this entire manual, and understand its content, and you are familiar with safety and proper use when operating this equipment. This air tool is part of a high pressure compressed air system, the following safety precautions must be followed at all times.



Wear hearing protection.  
Wear eye protection.  
Wear respiratory protection.

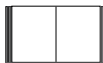

Read the instruction manual

# SAFETY INSTRUCTIONS

1)	Always wear protective goggles or safety glasses, hearing protection, protective gloves and footwear.
2)	Air tools can create dust when drilling, grinding, sanding or cutting. This dust can contain substances known to cause cancer, birth defect, etc. Also wear proper breathing protection.
3)	Do not wear loose clothing or jewelry, and ensure long hair is protected with a proper cover.
4)	Do not exceed the maximum operating pressure of this tool or any component in the air delivery system.
5)	Do not depress the trigger when connecting this tool to the air supply system. Always disconnect the tool from the air supply system when changing attachments.
6)	Only use attachments specifically designed for use with air tools. Hand tool sockets can shatter and cause serious injury. Do not use worn or damaged attachments. Make sure attachments are securely attached to the air tool.
7)	Do not point the air tool at yourself or any other person.
8)	Never use Oxygen or combustible gases to operate this tool. Use only lubricated compressed air regulated to the recommended operating pressure for this tool.
9)	Disconnect this tool from its air supply before attempting to install or change attachments or before attempting any service. Also disconnect the air tool from the compressed air system when not in use.
10)	Excessive use of this tool can cause injury due to vibration and fatigue. Do not use this tool in awkward positions, and avoid repetitive work motions. When feeling discomfort, numbness, fatigue, tingling or pain stop work immediately and seek medical treatment and advice.
11)	Inspect air hoses, and discard if in worn, weak or damaged condition. Make sure all air connections are tight and secure.
12)	Keep hands away from moving parts
13)	Consider working conditions and environment. Do not operate this tool around hazardous gases or flammable gases. Keep your work area neat and tidy and make sure the work area is well lit.
14)	Always use clamping devices to hold all work securely in place, never use hands or other body parts for holding work. Both hands must be used to operate this air tool, enabling control and safety.
15)	Do not use this air tool if intoxicated, if you are using drugs or medication causing drowsiness or if you are tired.
16)	Do not leave this air tool unattended, and disconnect from the air delivery system when not in use. Children must be supervised in the proximity of any air tool or work area.
17)	Follow air supply manufacturer's recommendation for connection of regulators, filters and other accessories. Do not install quick couplers directly on air tool, it puts unnecessary strain on the air inlet threads, instead install a short length of air hose to the tool. Do not over tighten fitting connecting to the air tool; this could cause the housing to crack. Use Teflon tape or pipe sealant carefully to prevent excess from entering the air tool.



Wear hearing protection.  
Wear eye protection.  
Wear respiratory protection.

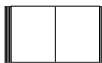

Read the instruction manual

---

# BEFORE USING THIS AIR TOOL

---

To ensure long life be sure to oil the tool daily. Pour 4 drops of Eagle air tool (SEA 20 non detergent) oil into the air inlet, and then run the tool for a few seconds to clean.

## If tool is an impact wrench fitted with a “Zirc” grease fitting:

The hammer mechanism of this tool also needs to be greased from time to time (depending on usage). The tool is equipped with grease fitting for this purpose; use this connection to re-grease the tool using Eagle impact wrench grease.

**PLEASE USE EAGLE SEA 20 NON DETERGENT OIL**

---

# OPERATING INSTRUCTIONS

---

To set the tool to desired torque, select a nut or screw of known tightness of the same size, thread, pitch and thread condition as those on the job. Turn air regulator to low position, apply wrench to nut and gradually increase power until nut moves slightly in the direction it was originally set. For additional power needed on disassembly work, turn regulator to its fully open position. This impact wrench is rated for 1” bolts. Do not use impact wrench beyond rated capacity as this will drastically reduce tool life.

---

# TROUBLESHOOTING

---

SYMPTOMS	CAUSE	REMEDY
Air tool does not run or runs slow.	Lack of lubrication.	Lubricate as per instructions.
	Dirt in tool.	Clean with mixture of 50/50 tool oil/solvent. Lubricate after cleaning.
	Insufficient air pressure.	Check regulator and air supply for leaks. Check compressor to make sure it operates at correct pressure. Make sure air hose is properly sized and that multiple hoses are not connected to same outlet. Check air hose for leaks and repair.
	Rotor blades worn or motor bearing worn or dirty.	Replace blades, inspect clean or replace bearing.
IMPACT WRENCH does not impact or impacts slowly.	See causes (above).	See remedies (above).
	Broken or worn impact mechanism.	Inspect and repair as required.



Wear hearing protection.  
Wear eye protection.  
Wear respiratory protection.

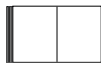

Read the instruction manual

# PARTS BREAKDOWN

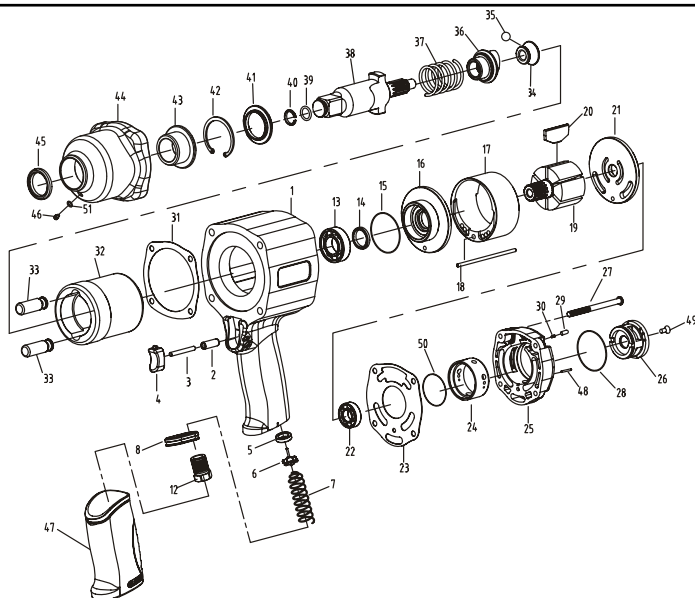

INDEX	PART	DESCRIPTION	QTY
1	361A-01	Housing	1
2	1460-26	Trigger Sleeve	1
3	361A-03	Pin	1
4	361A-04	Trigger	1
5	361A-05	Oil Seal	1
6	361A-06	Valve	1
7	361A-07	Spring	1
8	361A-08	Inlet Cap	1
12	361A-12	Inlet Connector	1
13	361A-13	Bearing	1
14	361A-14	Oil Seal	1
15	361A-15	O-Ring	1
16	361A-16	Front Plate	1
17	361A-17	Cylinder	1
18	361A-18	Set Pin	1
19	361A-19	Rotor	1
20	361A-20	Rotor Blade	6



Wear hearing protection.  
Wear eye protection.  
Wear respiratory protection.

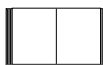

Read the instruction manual

21	361A-21	Read Plate	1
22	161-13	Bearing	1
23	361A-23	Seal Plate	1
24	361A-24	Valve Sleeve	1
25	361A-25	Rear Cover	1
26	361A-26	Switch	1
27	361A-27	Screw	4
28	361A-28	O-Ring	1
29	361A-29	Set Pin	1
30	660-25	Spring	1
31	660-26	Seal Plate	1
32	361A-32	Hammer	1
33	261-12	Hammer Pin	2
34	261-10	Foundation	1
35	261-48	Steel Ball	1
36	261-09	Drive Cam	1
37	261-47	Spring	1
38	261-08	Anvil	1
39	161-07	O-Ring	1
40	161-06	Anvil Collar	1
41	361A-41	Washer	1
42	361A-42	Retainer Ring	1
43	261-03	Bushing	1
44	361A-44	Front Cover	1
45	261-04	Oil Seal	1
46	165-10	Screw	1
47	361A-47	Handle Cover	1
48	151-41	Pin	1
49	361A-49	Plug	1
50	361A-50	Snap Ring	1
51	361A-51	Rubber Mat	1

Square drive .....3/4"  
 Max torque (FT/LBS) ..... 1000  
 Air pressure (PSI) .....90  
 Average air consumption (CFM).....6.5  
 Free speed (RPM).....4000  
 Air inlet (NPT).....1/4"  
 Hose size (ID).....3/8"



Wear hearing protection.  
 Wear eye protection.  
 Wear respiratory protection.

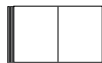

Read the instruction manual



Wood Industries, Inc.  
manufactures and distributes  
top of the line, high quality

**AIR COMPRESSORS  
AIR COMPRESSOR PARTS  
AIR POWERED ACCESSORIES**



**1-800-551-2406**  
[www.eaglecompressor.com](http://www.eaglecompressor.com)