



Operator Manual

Generator Set for Home Standby

C13N6H (Spec B)
C17N6H (Spec B)
C20N6H (Spec B)
C20N6HC (Spec B)

**CALIFORNIA
Proposition 65**

Warning: Natural Gas/Liquid Propane Gas engine exhaust and some of its constituents are known to the State of California to cause cancer, birth defects, and other reproductive harm.

Table of Contents

1. IMPORTANT SAFETY INSTRUCTIONS	1
1.1 Warning, Caution, and Note Styles Used in This Manual	1
1.2 General Information	1
1.3 Generator Set Safety Code	4
1.4 Moving Parts Can Cause Severe Personal Injury or Death	5
1.5 Electrical Shocks and Arc Flashes Can Cause Severe Personal Injury or Death.....	5
1.6 Fuel and Fumes Are Flammable	5
1.7 Batteries Can Explode	6
1.8 Exhaust Gases Are Deadly.....	7
1.9 The Hazards of Carbon Monoxide.....	9
1.10 Earth Ground Connection	9
2. INTRODUCTION.....	11
2.1 Safety.....	11
2.2 About This Manual.....	11
2.3 Schedule of Abbreviations	12
2.4 Related Literature	14
2.5 Model Specifications	15
2.6 After Sales Services.....	18
3. CONTROL SYSTEM.....	23
3.1 System Setup.....	23
3.2 Generator Set Status	43
4. OPERATION	49
4.1 Safety Considerations.....	49
4.2 Introduction	50
4.3 Maintenance	50
4.4 Generator Set Operation.....	50
4.5 Manual Start Sequence (Local)	56
4.6 Manual Stop Sequence (Local)	57
4.7 Manual Start/Stop Sequence (Remote).....	57
4.8 "Fault" and "New Event" Screens	57
4.9 Automatic Load Management.....	60
5. MAINTENANCE	63
5.1 Maintenance Safety	63
5.2 Periodic Maintenance	65
5.3 Engine Oil	70
5.4 Normal Duty Air Cleaner Element Replacement	76
5.5 Batteries.....	79
5.6 Brush Block and Slip Ring Maintenance	82
5.7 Cleaning the Generator Set Housing.....	83

5.8 Complete System Test	83
6. TROUBLESHOOTING	85
6.1 Avoiding Generator Set Shutdowns	85
6.2 Troubleshooting With the Local Display	85
6.3 Troubleshooting by Symptom	85
6.4 Troubleshooting with Fault Codes	86
6.5 Remote Monitoring Communication Troubleshooting.....	92

1 IMPORTANT SAFETY INSTRUCTIONS

SAVE THESE INSTRUCTIONS. This manual contains important instructions that should be followed during installation and maintenance of the generator set and batteries.

Safe and efficient operation can be achieved only if the equipment is properly operated and maintained. Many accidents are caused by failure to follow fundamental rules and precautions.

1.1 Warning, Caution, and Note Styles Used in This Manual

The following safety styles and symbols found throughout this manual indicate potentially hazardous conditions to the operator, service personnel, or equipment.

DANGER

Indicates a hazardous situation that, if not avoided, will result in death or serious injury.

WARNING

Indicates a hazardous situation that, if not avoided, could result in death or serious injury.

CAUTION

Indicates a hazardous situation that, if not avoided, could result in minor or moderate injury.

NOTICE

Indicates information considered important, but not hazard-related (e.g., messages relating to property damage).

1.2 General Information

This manual should form part of the documentation package supplied by Cummins with specific generator sets. If this manual has been supplied in isolation, please contact your authorized dealer.

NOTICE

It is in the operator's interest to read and understand all warnings and cautions contained in the documentation relevant to the generator set operation and daily maintenance.

General Safety Precautions

WARNING

Hazardous Voltage

Contact with high voltages can cause severe electrical shock, burns, or death.

Make sure that only a trained and experienced electrician makes generator set electrical output connections, in accordance with the installation instructions and all applicable codes.

WARNING

Electrical Generating Equipment

Faulty electrical generating equipment can cause severe personal injury or death.

Generator sets must be installed, certified, and operated by trained and experienced persons in accordance with the installation instructions and all applicable codes.

WARNING

Moving Parts

Moving parts can cause severe personal injury.

Use extreme caution around moving parts. All guards must be properly fastened to prevent unintended contact.

WARNING

Toxic Hazard

Used engine oils have been identified by some state and federal agencies to cause cancer or reproductive toxicity.

Do not ingest, breathe the fumes, or contact used oil when checking or changing engine oil. Wear protective gloves and face guard.

WARNING

Electrical Generating Equipment

Incorrect operation and maintenance can result in severe personal injury or death.

Do not operate equipment when fatigued, or after consuming any alcohol or drug.

Make sure that only suitably trained and experienced service personnel perform electrical and/or mechanical service.

⚠ WARNING**Toxic Gases**

Substances in exhaust gases have been identified by some state and federal agencies to cause cancer or reproductive toxicity.

Do not breathe in or come into contact with exhaust gases.

⚠ WARNING**High Noise Level**

Generator sets in operation emit noise, which can cause hearing damage.

Wear appropriate ear protection at all times.

⚠ WARNING**Hot Surfaces**

Contact with hot surfaces can cause severe burns.

The unit is to be installed so that the risk of hot surface contact by people is minimized. Wear appropriate PPE when working on hot equipment and avoid contact with hot surfaces.

⚠ WARNING**Combustible Liquid**

Ignition of combustible liquids is a fire or explosion hazard which can cause severe burns or death.

Do not store fuel, cleaners, oil, etc., near the generator set. Do not use combustible liquids like ether.

⚠ WARNING**Combustible Gases**

Generator sets in operation have combustible gases under pressure, which if ignited can cause eye and ear damage.

- **Wear appropriate eye and ear protection at all times.**
- **Do not operate the generator set with any doors open.**

⚠ WARNING**Fire Hazard**

Materials drawn into the generator set, as well as accumulated grease and oil, are a fire hazard. Fire can cause severe burns or death.

Keep the generator set and the surrounding area clean and free from obstructions. Make sure the generator set is mounted in a manner to prevent combustible materials from accumulating under the unit.

⚠ WARNING***Automated Machinery***

Accidental or remote starting of the generator set can cause severe personal injury or death.

The generator set must be off and locked out of service whenever the air inlet, air outlet, or any interior panels are removed.

⚠ WARNING***Automated Machinery***

Accidental or remote starting of the generator set can cause severe personal injury or death.

Isolate all auxiliary supplies and use an insulated wrench to disconnect the starting battery cables (negative [-] first).

NOTICE

Keep multi-type ABC fire extinguishers close by. Class A fires involve ordinary combustible materials such as wood and cloth. Class B fires involve combustible and flammable liquid fuels and gaseous fuels. Class C fires involve live electrical equipment. (Refer to NFPA No. 10 in the applicable region.)

NOTICE

Before performing maintenance and service procedures on enclosed generator sets, make sure the service access doors are secured open.

NOTICE

Stepping on the generator set can cause parts to bend or break, leading to electrical shorts, or to fuel, coolant, or exhaust leaks. Do not step on the generator set.

1.3 Generator Set Safety Code

Before operating the generator set, read the manuals and become familiar with them and the equipment. **Safe and efficient operation can be achieved only if the equipment is properly operated and maintained.** Many accidents are caused by failure to follow fundamental rules and precautions.

⚠ WARNING***Electrical Generating Equipment***

Incorrect operation and maintenance can result in severe personal injury or death.

Read and follow all Safety Precautions, Warnings, and Cautions throughout this manual and the documentation supplied with the generator set.

1.4 Moving Parts Can Cause Severe Personal Injury or Death

- Keep hands, clothing, and jewelry away from moving parts.
- Before starting work on the generator set, disconnect the battery charger from its AC source, then disconnect the starting batteries using an insulated wrench, negative (–) cable first. This will prevent accidental starting.
- Make sure that fasteners on the generator set are secure. Tighten supports and clamps; keep guards in position over fans, drive belts, etc.
- Do not wear loose clothing or jewelry in the vicinity of moving parts or while working on electrical equipment. Loose clothing and jewelry can become caught in moving parts.
- If any adjustments must be made while the unit is running, use extreme caution around hot manifolds, moving parts, etc.

1.5 Electrical Shocks and Arc Flashes Can Cause Severe Personal Injury or Death

- Only qualified service personnel certified and authorized to work on power circuits should work on exposed energized power circuits.
- All relevant service material must be available for any electrical work performed by certified service personnel.
- Exposure to energized power circuits with potentials of 50 VAC or 75 VDC or higher poses a significant risk of electrical shock and electrical arc flash.
- Refer to standard NFPA 70E, or equivalent safety standards in corresponding regions, for details of the dangers involved and for safety requirements.

1.6 Fuel and Fumes Are Flammable

Fire, explosion, and personal injury or death can result from improper practices.

- DO NOT permit any flame, cigarette, pilot light, spark, arcing equipment, or other ignition source near the generator set or fuel system.

- Fuel lines must be adequately secured and free of leaks. Fuel connection at the engine should be made with an approved flexible line. Do not use copper piping on flexible lines because copper will become brittle if continuously vibrated or repeatedly bent.
- Be sure all fuel supplies have a positive shutoff valve.
- Be sure the battery area has been well-ventilated prior to servicing near it. Lead-acid batteries emit a highly explosive hydrogen gas that can be ignited by arcing, sparking, smoking, etc.

Do Not Operate in Flammable and Explosive Environments

Flammable vapor can cause an engine to over speed and become difficult to stop, resulting in possible fire, explosion, severe personal injury, and death. Do not operate a generator set where a flammable vapor environment can be created, unless the generator set is equipped with an automatic safety device to block the air intake and stop the engine. The owners and operators of the generator set are solely responsible for operating the generator set safely. Contact your authorized Cummins distributor for more information.

Spillage

Any spillage that occurs during fueling, oil top-off, or oil change must be cleaned up before starting the generator set.

Fluid Containment

NOTICE

Where spillage containment is not part of a Cummins supply, it is the responsibility of the installer to provide the necessary containment to prevent contamination of the environment, especially water courses and sources.

If fluid containment is incorporated into the bedframe, it must be inspected at regular intervals. Any liquid present should be drained out and disposed of in line with local health and safety regulations. Failure to perform this action may result in spillage of liquids which could contaminate the surrounding area.

Any other fluid containment area must also be checked and emptied, as described above.

1.7 Batteries Can Explode

Batteries can explode, causing severe skin and eye burns and can release toxic electrolytes.

⚠ WARNING**Combustible Gases**

Batteries can explode, causing severe skin and eye burns, and can release toxic electrolytes.

Do not dispose of the battery in a fire, because it is capable of exploding. Do not open or mutilate the battery. Do not charge frozen batteries.

⚠ WARNING**Electric Shock Hazard**

Batteries present the risk of high short circuit current.

When servicing the generator set:

- **Remove watches, rings, or other metal objects.**
- **Use tools with insulated handles.**

NOTICE

Servicing of batteries must be performed or supervised by personnel knowledgeable of batteries and the required precautions. Keep unauthorized personnel away from batteries.

- Wear safety glasses.
- Do not smoke.
- Do not charge frozen batteries.
- To prevent arcing when disconnecting the battery:
 1. Press the Off switch from the display and then press the E-Stop button (if equipped).
 2. Disconnect AC power from any battery chargers.
 3. Remove the negative (-) battery cables to prevent starting.
- To prevent arcing when reconnecting the battery:
 1. Reconnect the positive (+) cables.
 2. Reconnect the negative (-) cables.
 3. Reconnect the battery charger to AC power supply.
- When replacing the generator set battery, always replace it with a battery as specified in this manual.

1.8 Exhaust Gases Are Deadly

- Provide an adequate exhaust system to properly expel discharged gases away from enclosed or sheltered areas, and areas where individuals are likely to congregate. Visually and audibly inspect the exhaust system daily for leaks per the maintenance schedule. Make sure that exhaust manifolds are secured and not warped. Do not use exhaust gases to heat a compartment.

- Make sure the unit is well ventilated.

Exhaust Precautions

WARNING

Hot Exhaust Gases

Contact with hot exhaust gases can cause severe burns.

Wear personal protective equipment when working on equipment.

WARNING

Hot Surfaces

Contact with hot surfaces can cause severe burns.

The unit is to be installed so that the risk of hot surface contact by people is minimized. Wear appropriate PPE when working on hot equipment and avoid contact with hot surfaces.

WARNING

Toxic Gases

Inhalation of exhaust gases can cause asphyxiation and death.

Pipe exhaust gas outside and away from windows, doors, or other inlets to buildings. Do not allow exhaust gas to accumulate in habitable areas.

WARNING

Fire Hazard

Contaminated insulation is a fire hazard. Fire can cause severe burns or death.

Remove any contaminated insulation and dispose of it in accordance with local regulations.

Make sure that the exhaust outlet is not obstructed. Personnel using this equipment must be made aware of the exhaust position. Position the exhaust away from flammable materials and make sure that vegetation is removed from the vicinity of the exhaust.

To minimize the risk of fire, make sure that the engine is allowed to cool thoroughly before performing maintenance or operation tasks.

1.9 The Hazards of Carbon Monoxide

Carbon monoxide (CO) is an odorless, colorless, tasteless and non-irritating gas. You cannot see it or smell it. Red blood cells, however, have a greater affinity for CO than for oxygen. Therefore, exposure even to low levels of CO for a prolonged period can lead to asphyxiation (lack of oxygen) resulting in death. Mild effects of CO poisoning include eye irritation, dizziness, headaches, fatigue and the inability to think clearly. More extreme symptoms include vomiting, seizures and collapse.

Engine-driven generator sets produce harmful levels of carbon monoxide that can injure or kill you.

Special Risks of CO near the Home

WARNING

Toxic Gases

Carbon monoxide (CO) gas can cause nausea, fainting, or death. Residents can be exposed to lethal levels of CO when the generator set is running. Depending on air temperature and wind, CO can accumulate in or near the home.

To protect yourself and others from the dangers of CO poisoning, it is recommended that reliable, approved, and operable CO detector alarms are installed in proper locations in the home as specified by their manufacturer.

Protecting Yourself from CO Poisoning

- Locate the generator set in an area where there are no windows, doors, or other access points into the home.
- Make sure all CO detectors are installed and working properly.
- Pay attention for signs of CO poisoning.
- Check the exhaust system for corrosion, obstruction, and leaks every time you start the generator set and every eight hours when you run it continuously.

1.10 Earth Ground Connection

The neutral of the generator set may be required to be bonded to earth ground at the generator set location, or at a remote location, depending on system design requirements. Consult the engineering drawings for the facility or a qualified electrical design engineer for proper installation.

NOTICE

The end user is responsible to make sure that the ground connection point surface area is clean and free of rust before making a connection.

NOTICE

The end user is responsible for making sure that an earthing arrangement that is compliant with local conditions is established and tested before the equipment is used.

2 Introduction

2.1 Safety

 **WARNING**

Hazardous Voltage

Contact with high voltages can cause severe electrical shock, burns, or death.

Make sure that only a trained and experienced electrician makes generator set electrical output connections, in accordance with the installation instructions and all applicable codes.

 **WARNING**

Electrical Generating Equipment

Faulty electrical generating equipment can cause severe personal injury or death.

Generator sets must be installed, certified, and operated by trained and experienced persons in accordance with the installation instructions and all applicable codes.

2.2 About This Manual

The purpose of this manual is to provide the users with sound, general information. It is for guidance and assistance with recommendations for correct and safe procedures. Cummins Inc. cannot accept any liability whatsoever for problems arising as a result of following recommendations in this manual.

The information contained within the manual is based on information available at the time of going to print. In line with Cummins Inc. policy of continuous development and improvement, information may change at any time without notice. The users should therefore make sure that they have the latest information available before starting any work. The latest version of this manual is available on QuickServe Online (<https://quickserve.cummins.com>).

Users are respectfully advised that, in the interests of good practice and safety, it is their responsibility to employ competent people to carry out any installation work. Consult your authorized dealer for further installation information. It is essential that the utmost care is taken with the application, installation, and operation of any generator set due to their potentially hazardous nature. Careful reference should also be made to other Cummins Inc. literature. You must operate and maintain your generator set properly if you are to expect safe and reliable operation.

For further assistance, contact your authorized Cummins Inc. dealer.

NOTICE

This device complies with part 15 of the FCC rules. Operation is subject to the following two conditions:

- This device may not cause harmful interferences.
- This device must accept any interference received, including interference that may cause undesired operation.

2.3 Schedule of Abbreviations

This list is not exhaustive. For example, it does not identify units of measure or acronyms that appear only in parameters, event/fault names, or part/accessory names.

Abbr.	Description	Abbr.	Description
AC	Alternating Current	LED	Light-Emitting Diode
AMP	AMP, Inc. (part of Tyco Electronics)	MFM	Multifunction Monitor
ANSI	American National Standards Institute	Mil Std	Military Standard
ASOV	Automatic Shut Off Valve	MPU	Magnetic Pickup
ASTM	American Society for Testing and Materials (ASTM International)	NC	Normally Closed
ATS	Automatic Transfer Switch	NC	Not Connected
AVR	Automatic Voltage Regulator	NFPA	National Fire Protection Agency
AWG	American Wire Gauge	NO	Normally Open
CAN	Controlled Area Network	NWF	Network Failure
CB	Circuit Breaker	OEM	Original Equipment Manufacturer
CE	Conformité Européenne	OOR	Out Of Range
CCA	Cold Cranking Ampere	OORH/ ORH	Out Of Range High
CFM	Cubic Feet per Minute	OORL/ORL	Out Of Range Low
CGT	Cummins Generator Technologies	PB	Push Button
CMM	Cubic Meters per Minute	PCC	PowerCommand® Control

Abbr.	Description	Abbr.	Description
CT	Current Transformer	PGI	Power Generation Interface
DC	Direct Current	PGN	Parameter Group Number
DEF	Diesel Exhaust Fluid	PI	Proportional/Integral
DPF	Diesel Particulate Filter	PID	Proportional/Integral/ Derivative
EBS	Excitation Boost System	PLC	Programmable Logic Controller
ECM	Engine Control Module	PMG	Permanent Magnet Generator
ECS	Engine Control System	PPE	Personal Protective Equipment
EMI	Electromagnetic Interference	PT	Potential Transformer
EN	European Standard	PTC	Power Transfer Control
EPS	Engine Protection System	PWM	Pulse-Width Modulation
E-Stop	Emergency Stop	RFI	Radio Frequency Interference
FAE	Full Authority Electronic	RH	Relative Humidity
FMI	Failure Mode Identifier	RMS	Remote Monitoring System
FSO	Fuel Shutoff	RMS	Root Mean Square
Genset	Generator Set	RTU	Remote Terminal Unit
GCP	Generator Control Panel	SAE	Society of Automotive Engineers
GND	Ground	scfh	Standard Cubic Feet of gas per Hour
HMI	Human-Machine Interface	SCR	Selective Catalytic Reduction
IC	Integrated Circuit	SPN	Suspect Parameter Number
ISO	International Organization for Standardization	SW_B+	Switched B+
LBNG	Lean-Burn Natural Gas	UL	Underwriters Laboratories

Abbr.	Description	Abbr.	Description
LCD	Liquid Crystal Display	UPS	Uninterruptible Power Supply
LCT	Low Coolant Temperature		

2.4 Related Literature

Before any attempt is made to operate the generator set, the operator should take time to read all of the manuals supplied with the generator set and familiarize themselves with the warnings and operating procedures.

NOTICE

A generator set must be operated and maintained properly if you are to expect safe and reliable operation. The Operator manual includes a maintenance schedule and a troubleshooting guide.

The Health and Safety manual must be read in conjunction with this manual for the safe operation of the generator set, as well as the Warranty Statements.

The literature provided with the generator set is as follows:

- Installation Manual (A062J678)
- Operator Manual (A062J680)
- Quick Start Installation Guide (A062M459)
- Quick Start Operator Guide (A062M461)
- Health and Safety Manual (0908-0110-00)
- Global Warranty Statement (A056F206)
- Emission Warranty Statement (Federal Emissions EPA Title 40 CFR Part 90 Component Warranty) (A028X278)

The relevant manuals appropriate to your generator set are also available. The documents below are in English:

- Generator Set Service Manual (A062J683)
- RA Series RA112L1 Automatic Transfer Switch Owner Manual (A052S254) - if applicable
- RA Series Automatic Transfer Switch Owner Manual (A046S594) (models RA112N3, RA212N3, RA112S3, RA212S3, RA412N3, and RA412S3) - if applicable
- Parts Manual (A053X179)
- Standard Repair Times - HO Family (A053X186)
- Service Tool Manual (A043D529)

- Warranty Failure Code Manual (F1115C)
- Engineering Application Manual T-030: Liquid Cooled Generator Sets (A040S369)

2.5 Model Specifications

TABLE 1. MODEL VARIATIONS

Model	Natural Gas or Propane Vapor	kW	Amps	Frequency	Voltage
C13N6H	Both	13	54.2	60 Hz	120/240 VAC Single Phase
C17N6H	Both	17	70.8		
C20N6H, C20N6HC	Natural Gas Only	18	75		
	Propane Vapor Only	20	83.3		

NOTICE

Maximum load imbalance allowed is 50% of generator set rating.

TABLE 2. COLD WEATHER REQUIREMENTS

Temperature	Description
Above 4 °C (40 °F)	No starting aids required
-17 to 4 °C (0 to 40 °F)	Alternator heater
Below -17 °C (0 °F)	<ul style="list-style-type: none"> • Alternator heater • 0W30 oil (see the oil recommendation below) • Extreme cold weather kit (A054B984) (includes battery and oil heaters)

TABLE 3. FUEL CONSUMPTION SPECIFICATIONS (AT FULL LOAD)

Type	C13N6H		C17N6H		C20N6H, C20N6HC		Fuel Pressure	
	scfh	BTU/hr	scfh	BTU/hr	scfh	BTU/hr	kPa	in water column
Natural Gas	228	217,200	258	246,000	268	256,000	0.9–3.0	3.5–12
Propane	83	197,700	102	242,400	112	266,000	1.5–3.0	6–12

	C13N6H		C17N6H		C20N6H, C20N6HC		Fuel Pressure	
Type	scfh	BTU/hr	scfh	BTU/hr	scfh	BTU/hr	kPa	in water column
Note: Maximum pressure for either fuel under any condition: 3.2 kPa (13 inch water column)								

TABLE 4. ENGINE SPECIFICATIONS

Type	Value
Engine	2 cylinder v-twin, OHV, air-cooled, 4-stroke, spark ignited
Displacement	999 cc (60.9 in ³)
Spark Plug Gap	0.38–0.58 mm (0.015–0.023 in)
Spark Plug Torque (Cold Engine)	25–30 Nm (18–22 ft-lb)
Magneto Gap	0.25–0.35 mm (0.010–0.014 in)
RPM	3600
Lubricating Oil Pressure at Rated Speed (Minimum)	310 kPa (45 psi)
Oil Recommendation	Full synthetic gasoline engine oil which meets or exceeds API service SN/SN-RC and ILSAC GF-5: <ul style="list-style-type: none"> • 5W30: Temperatures above –17 °C (0 °F) • 0W30: All temperatures, required below –17 °C (0 °F)
Lubricating Oil Capacity:	
Lubricating Oil Pressure at Rated Speed (Minimum)	310 kPa (45 psi)
--Full at High Mark on Dipstick	2.3 L (2.4 qt)
--Low Mark on Dipstick	1.3 L (1.4 qt)

TABLE 5. GENERATOR SET SIZE

Dimension	Value
Length	865 mm (34.1 in)
Width	915 mm (36 in)
Height	694 mm (27.3 in)

TABLE 6. GENERATOR SET WET WEIGHT (INCLUDING BATTERY)

Model	Value
C13N6H	218 kg (479 lb)
C17N6H, C20N6H, C20N6HC	241 kg (531 lb)

TABLE 7. GENERATOR SET DERATING GUIDELINES

Model	Engine Power Available Up To...		Derate At...	
	Elevation	Ambient Temperature	Elevation	Temperature
C13N6H	2100 m (6900 ft)	25 °C (77 °F)	3.5% per 300 m (1000 ft)	1% per 5.5 °C (10 °F)
C17N6H	300 m (1000 ft)	25 °C (77 °F)		
C20N6H, C20N6HC	0 m (0 ft)	15 °C (60 °F)		

NOTICE

Derating guidelines: This product's output power is limited by factors such as BTU content of fuel, ambient temperature, altitude, humidity, engine condition, etc. The derating guidelines are based on properly maintained product, using the appropriate fuel. Derate values are based on expected engine power changes from elevation and temperatures listed.

TABLE 8. ALTERNATOR SPECIFICATIONS

Type	Specification
Design	Rotating field
Poles	2
RPM	3600
Voltage	240
Hz	60

TABLE 9. CONTROL SPECIFICATIONS

Control
Integrated Microprocessor-Based Engine, Alternator, Transfer Switch Controller

TABLE 10. DC SYSTEM SPECIFICATIONS

Type	Value
Nominal Battery Voltage	12 VDC
Battery Group	51 R
Battery Type	Lead Acid
Minimum Cold Crank Amps (CCA)	450

2.6 After Sales Services

Cummins offers a full range of maintenance and warranty services.

Maintenance

WARNING

***Electrical Generating Equipment
Incorrect service or parts replacement can result in severe personal injury,
death, and/or equipment damage.
Make sure service personnel are qualified to perform electrical and
mechanical service.***

For expert generator set service at regular intervals, contact your Cummins service provider. See power.cummins.com/sales-service-locator for service locations that service this application. Maintenance tasks should only be undertaken by trained and experienced technicians provided by your Cummins service provider.

Warranty

For details of the warranty coverage for your generator set, refer to the *Warranty Statement* listed in the Related Literature section.

Extended warranty coverage is also available. In the event of a breakdown, prompt assistance can normally be given by factory trained service technicians with facilities to undertake all minor and many major repairs to equipment on site.

For further warranty details, contact your authorized dealer.

NOTICE

Damage caused by failure to follow the manufacturer's recommendations will not be covered by the warranty. Please contact your authorized dealer.

Warranty Limitations

For details of the warranty limitations for your generator set, refer to the warranty statement applicable to the generator set.

How to Obtain Service

For parts, service, and product information, contact the nearest authorized Cummins dealer. To easily locate the nearest certified distributor/dealer for Cummins generator sets in your area, or for more information, contact us at 1-800-CUMMINS™ (1-800-286-6467) or visit www.cummins.com/support.

Generator Set Nameplate

WARNING

Electrical Generating Equipment

Improper service or replacement of parts can lead to severe personal injury or death and to damage to equipment and property.

Make sure service personnel are qualified to perform electrical and mechanical service.

NOTICE

Unauthorized modifications or replacement of fuel, exhaust, air intake or speed control system components that affect engine emissions are prohibited by law in the State of California.

Model, Spec, and Serial Numbers: Be ready to provide the model, spec, and serial numbers on the generator set nameplate when contacting Cummins for information, parts, and service. The nameplate is located on the inside of the customer access door on enclosed generator sets.

Record these numbers so that they are easy to find when needed. Each character in these numbers is significant for obtaining the right parts listed in the Parts Catalog. Genuine Cummins replacement parts are recommended for best results.

My Generator Set Information

Model	
Spec	
Serial Number	

Manufacturing Facilities

Facility	Address	Phone Numbers
U.S. and CANADA	Cummins Inc. 1400 73rd Ave. NE Minneapolis, MN 55432 USA	Toll Free 1-800-CUMMINS™ (1-800-286-6467) Phone +1 763-574-5000 Fax +1 763-574-5298
EMEA, CIS	Cummins Inc. Columbus Avenue Manston Park Manston, Ramsgate Kent CT12 5BF United Kingdom ----- Cummins Inc. Royal Oak Way South Daventry Northamptonshire NN11 8NU United Kingdom	Phone +44 1843 255000 Fax +44 1843 255902
ASIA PACIFIC	Cummins Inc. 10 Toh Guan Road #07-01 TT International Tradepark Singapore 608838	Phone +65 6417 2388 Fax +65 6417 2399
BRAZIL	Rua Jati, 310, Cumbica Guarulhos, SP 07180-900 Brazil	Phone +55 11 2186 4195 Fax +55 11 2186 4729
CHINA	Cummins Inc. 2 Rongchang East Street, Beijing Economic – Technological Development Area Beijing 100176, P.R. China	Phone 86 10 59023001 Fax +86 10 5902 3199
INDIA	Cummins Inc. Plot No B-2, SEZ Industrial Area, Village-Nandal & Surwadi, Taluka- Phaltan Dist- Satara, Maharashtra 415523 India	Phone +91 021 66305514
LATIN AMERICA	3350 Southwest 148th Ave. Suite 205 Miramar, FL 33027 USA	Phone +1 954 431 551 Fax +1 954 433 5797

Facility	Address	Phone Numbers
MEXICO	Eje 122 No. 200 Zona Industrial San Luis Potosi, S.L.P. 78395 Mexico	Phone +52 444 870 6700 Fax +52 444 824 0082

This page is intentionally blank.

3 Control System

3.1 System Setup

"Establishing Communications" Message

NOTICE

Once the battery is connected to the generator set and any display button is pressed, the local display shows an "establishing communications" message for approximately 5 seconds. (This may take longer if the signal integrity is poor between the control and display due to a bad wire or Electro-Magnetic Interference [EMI].) Once communication is established, the display shows the HOME screen.

The "establishing communications" message will also be displayed whenever the control is brought out of "sleep" mode by pressing any button on the display. Sleep mode is entered after 30 minutes without utility or generator set power to preserve battery energy since the battery charger will not have AC power. The 30-minute timer is reset with any button press on the display.

Operating the Generator Set Cover Safely

To configure the local display or access the generator set, you will need to lift the cover (lid). The cover of the generator set is designed to latch securely into the "up" position to prevent accidental closure.

- *To open:* Lift the cover until the hinge pin drops into the hinge pin slot. Test that the cover is secure by gently pressing down on the cover.
- *To close:* Lift up on the cover while pressing upward on the hinge pin and slide the pin upwards out of the hinge pin slot. Carefully push the cover downward and let go of the hinge pin allowing it to ride along the hinge until the cover is closed.

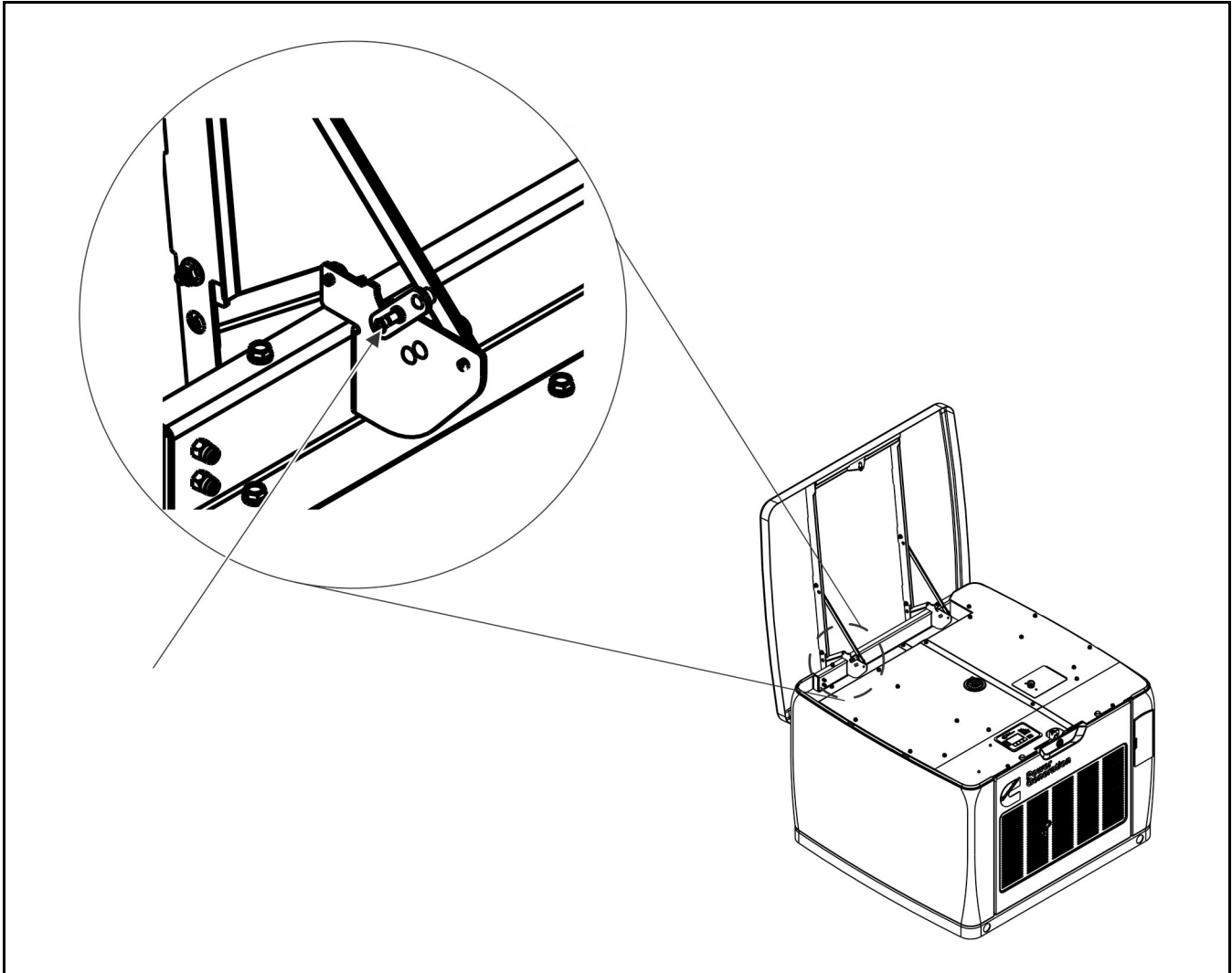

FIGURE 1. HINGE LOCATION

"Clock Setup" Screen

NOTICE

The Clock needs to be reset whenever the battery power is lost or disconnected, or the control has entered "sleep" mode. Sleep mode is entered after 30 minutes without utility or generator set power to preserve battery energy since the battery charger will not have AC power. The 30-minute timer is reset with any button press on the display.

NOTICE

The optional Remote Monitoring System (RMS) uses the generator set's clock. The clock must be set accurately for the RMS to function properly.

To set up the generator set clock for the current date and time:

1. From the Main screen, select **Menu**.
2. Use the arrow keys to highlight **Clock**. Select the **Enter** key.
3. Use the arrow keys to set the time and date.

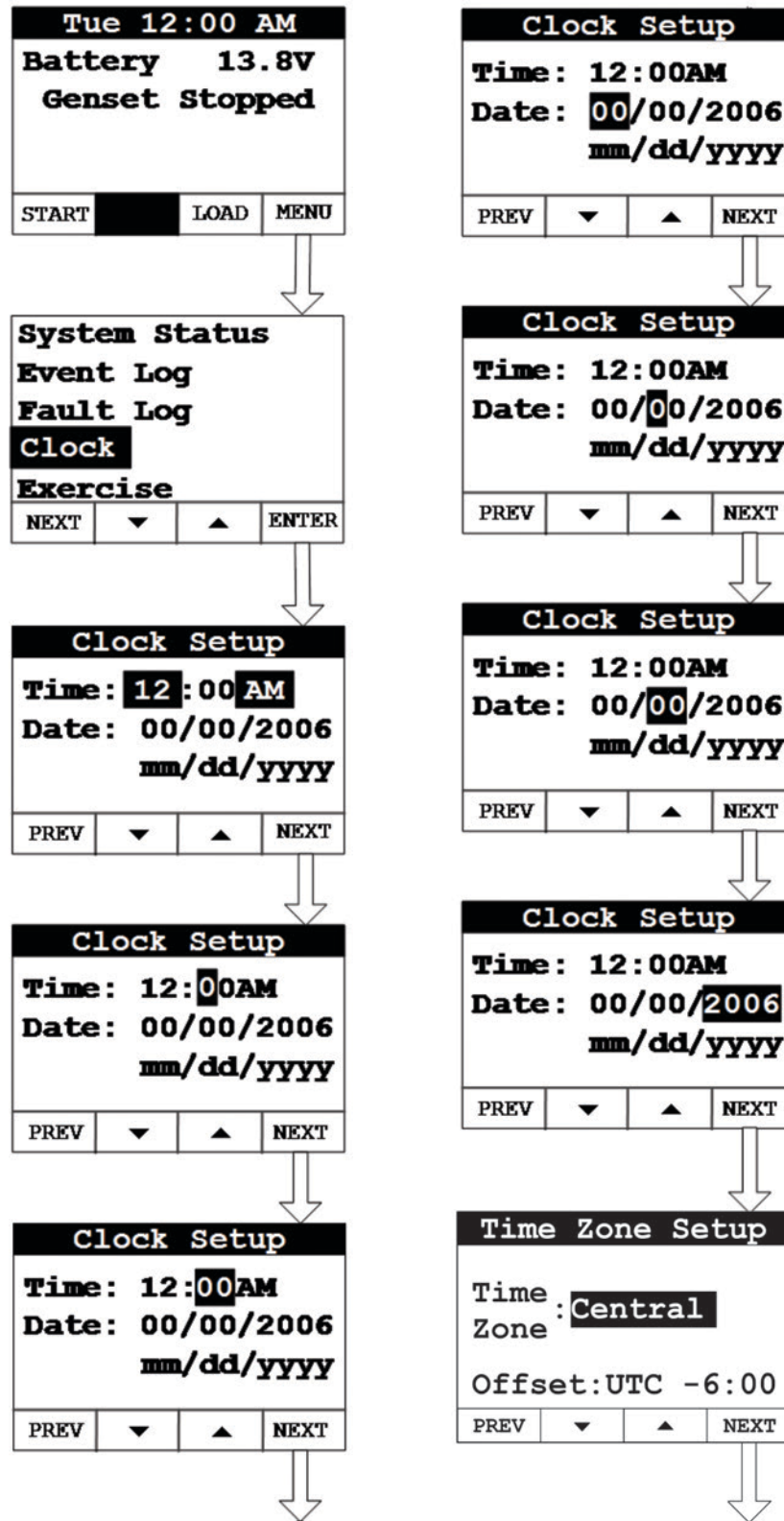

FIGURE 2. CLOCK SETUP SCREEN

4. Select the **Next** key to go to the Daylight Savings screen.

-
5. Use the arrow keys to enable/disable Daylight Savings. If enabling, select the **Next** key to highlight the **Offset** field.

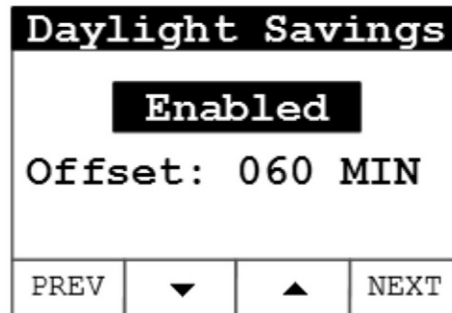

FIGURE 3. DAYLIGHT SAVINGS TIME (ENABLED)

6. Use the arrow keys and **Next** key to set the offset value for Daylight Savings time.

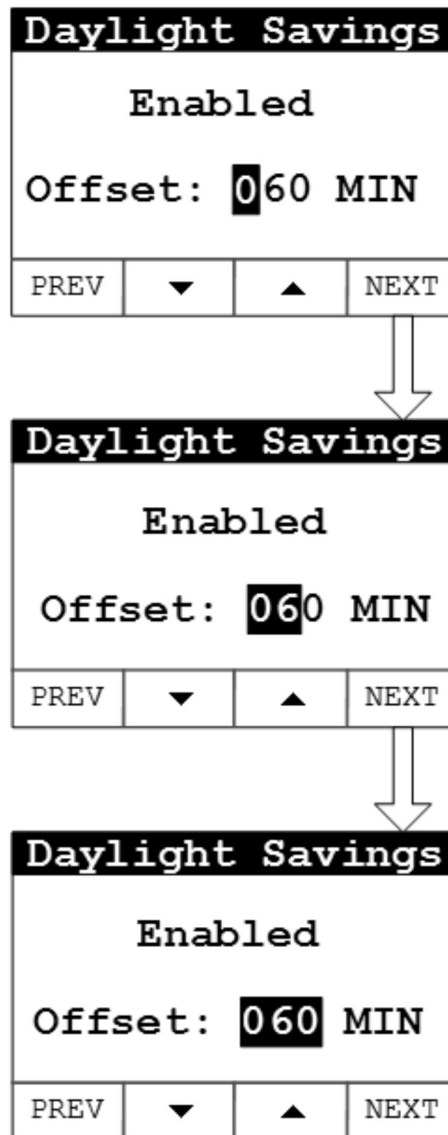

FIGURE 4. OFFSET VALUE

7. Select the **Next** key to go the screen that is used to set up when Daylight Savings should start. Use the arrow keys and **Next** key to set Month (1 – 12), Week (0 – 5), Day (Sun – Sat) and Hour (12AM – 12PM).

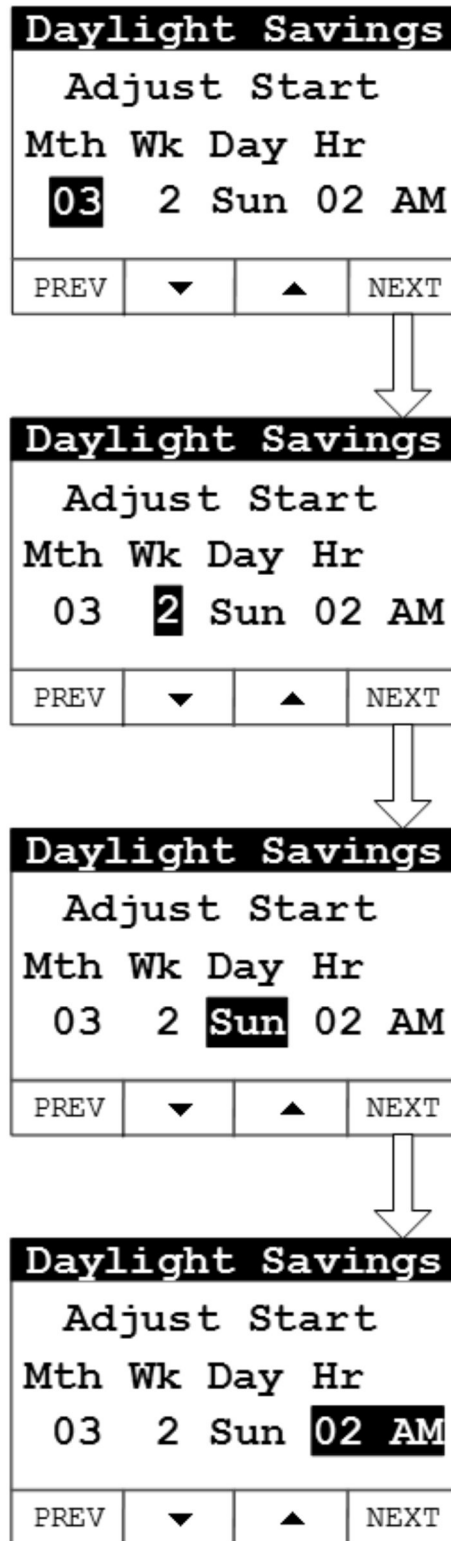

FIGURE 5. DAYLIGHT SAVINGS TIME (START TIME SETUP)

- 8. Select the **Next** key to go the screen that is used to set up when Daylight Savings should end. Use the arrow keys and **Next** key to set Month (1 – 12), Week (0 – 5), Day (Sun – Sat) and Hour (12AM – 12PM).

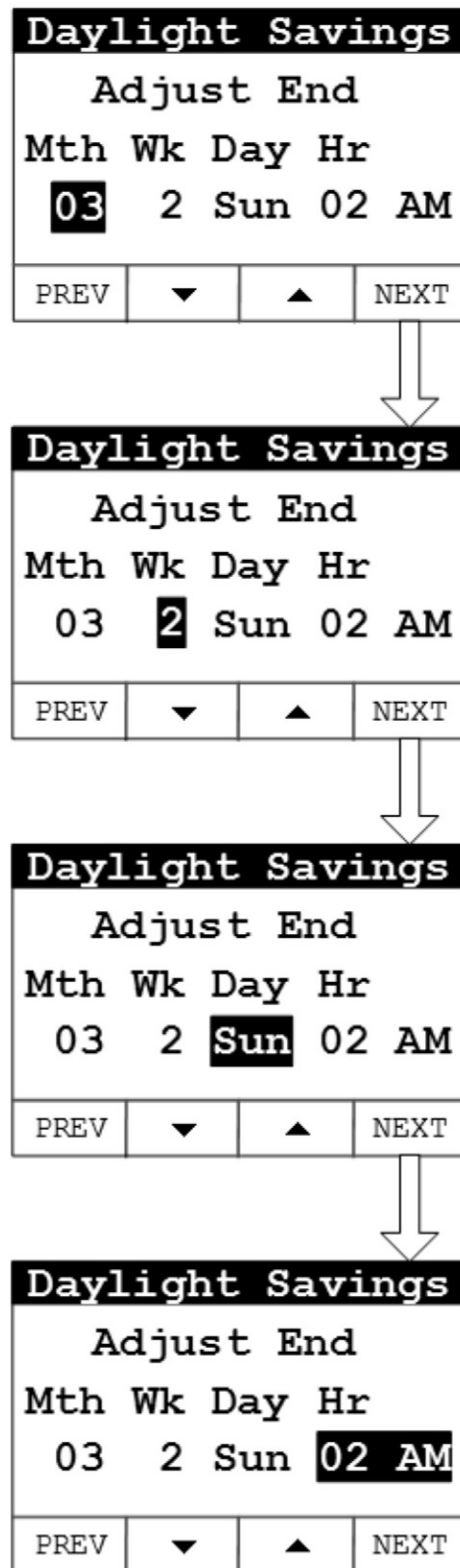

FIGURE 6. DAYLIGHT SAVINGS TIME (END TIME SETUP)

9. Keep selecting the **Back** button to save the settings and return to the main screen.

"Exercise" Screen

When installing an RA series transfer switch, follow these steps to configure the Exercise mode in the generator set's local display or remote display.

NOTICE

Exercise settings need to be reset whenever battery power is lost or disconnected, or the control has entered "sleep" mode.

NOTICE

Sleep mode is entered after 30 minutes without utility or generator set power to preserve battery energy since the battery charger will not have AC power. The 30-minute timer is reset with any button press on the display.

To set up the exercise function:

1. From the Main screen, select **Menu**.
2. Use the arrow keys to highlight **Exercise**. Select the **Enter** key.

NOTICE

If the time and date have not been set, a pop-up will appear that says, "Set Valid Date and Time". The exercise schedule references the generator set date and time so it must be set accurately to be properly configured.

3. Use the arrow keys to enable or disable the **Crank Exercise** feature. Select the **Next** key to go to the **Exercise Time** field. See the Exercise Sequences section in the operator manual for more information.

NOTICE

When the Crank Exercise feature is enabled, an exercise command will cause the engine starter to engage and rotate the engine, but will not allow the engine to start. This feature allows the control system to monitor critical generator set systems without running the engine. When Crank Exercise is enabled, the generator set's exercising will alternate between the Crank Exercise sequence and the standard exercise sequence (that is, engine running) at scheduled times.

4. Use the arrow keys to set how long the generator set will exercise (from 1 to 20 minutes). Select the **Next** key to go to the **Exercise** field. The Exercise Sched screen appears.
5. Use the arrow keys to set how often the generator set will exercise. The frequency selections are:
 - Weekly: will exercise the generator set on every occurrence of the selected day

-
- Bimonthly: will exercise the generator set on the first and third occurrence of the selected day every month
 - Monthly: will exercise the generator set on the first occurrence of the selected day every month
 - Never: will never exercise the generator set

Select the **Next** key to go to the date and time fields.

6. Use the arrow keys to set the day and time the generator set will be exercised. Select the **Next** key to highlight the **Exercise Now** field.
7. Select either arrow key to start the Exercise Now function.

NOTICE

Initiating the Exercise Now function will cause the generator set to start immediately and run for the amount of time indicated by the Exercise Time field, or run the Crank Exercise sequence. The ATS does not transfer to generator power during exercise mode. Normally scheduled exercise events will occur after the completion of the immediate exercise event.

8. Keep selecting the **Back** button to save the settings and return to the Main screen.

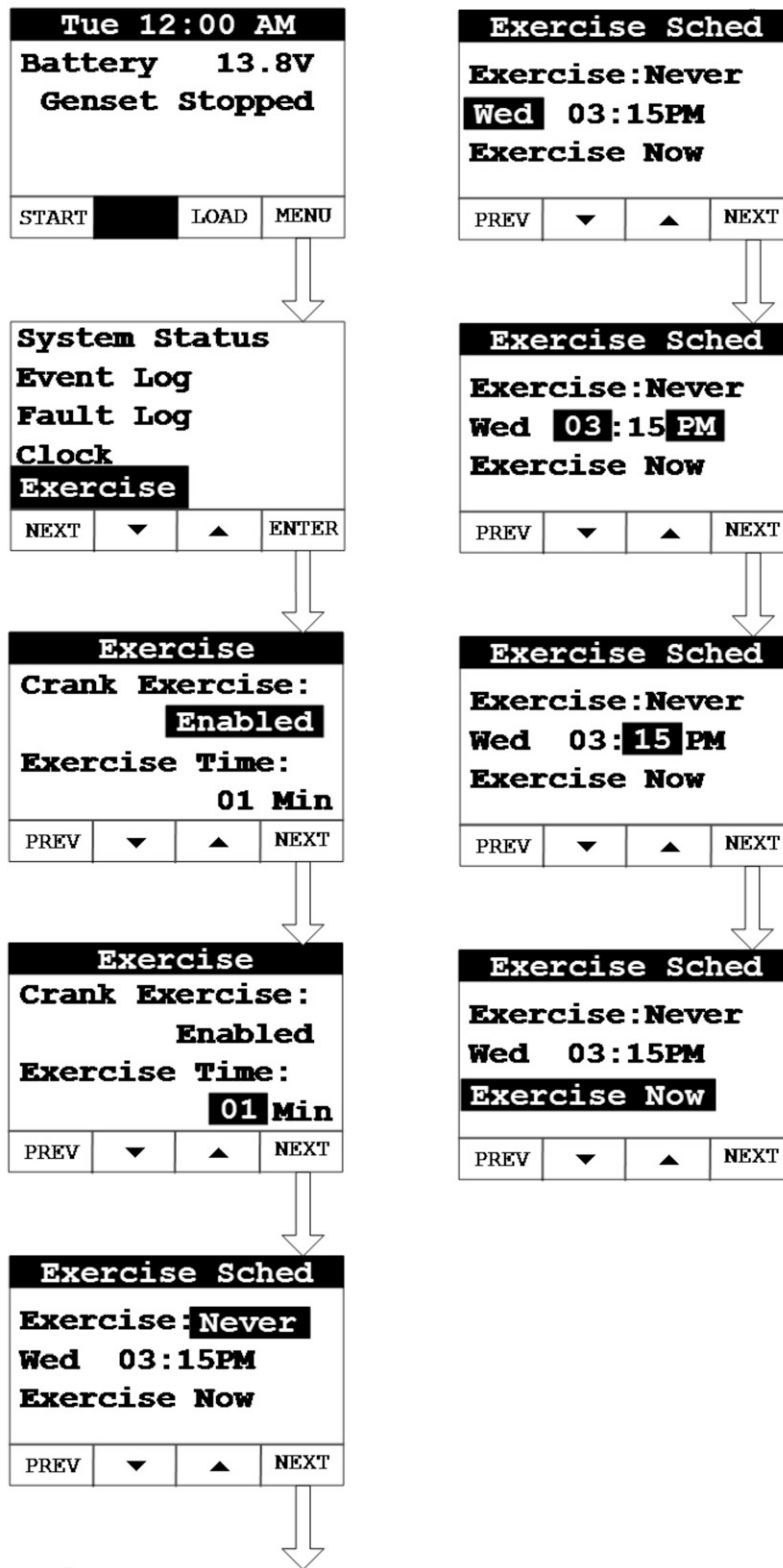

FIGURE 7. EXERCISE SETUP SCREEN

"Brightness and Contrast" Screen

To adjust the brightness and contrast of the display:

1. From the Main screen, select **Menu**.
2. Use the arrow keys to highlight **Display Setup**. Select the **Enter** key.
3. Use the arrow keys to set brightness and contrast for the display.
4. Keep selecting the **Back** button to save the settings and return to the Main screen.

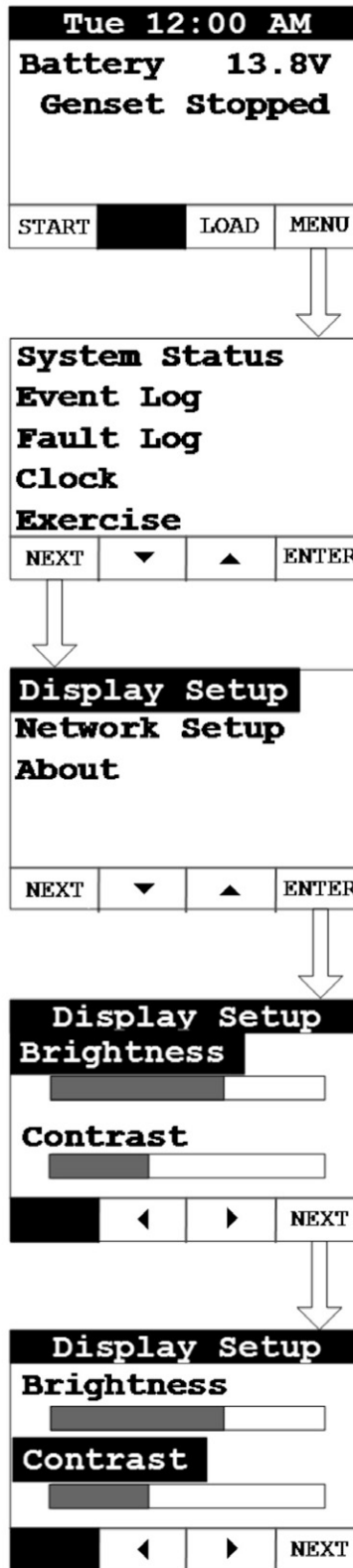

FIGURE 8. BRIGHTNESS AND CONTRAST SCREEN

"Mode" Screen

When Remote is set to Enabled via the local display, the "Remote On" LED on the front of the display will illuminate indicating that the control will accept start commands from remote displays or remote monitoring systems including a web page or cell phone app.

NOTICE

The Remote function can only be activated (that is, enabled) from the local display.

When Standby is on or set to Enabled, the "Standby On" LED on the front of the display will illuminate indicating the control will start the generator set in response to a utility power outage. Standby can be turned on at the local display. It can also be enabled with a remote display, web page, or a cell phone app if Remote has already been enabled at the local display. The Standby function **cannot** be enabled remotely unless the Remote function is on. A manual Start or Stop event will disable the Standby function. (If the manual Stop event is performed at the local display, the Remote mode will also be disabled.)

1. To enable or disable the Remote and Standby modes on the **LOCAL** display, do the following:
 - a. From any screen, select the **Mode** key to get to the Mode screen.
 - b. Use the arrow keys to enable or disable the Remote mode. Select the **Next** key to go to the next screen.
 - c. Use the arrow keys to enable or disable the Standby mode.

NOTICE

Whenever Standby is enabled, the Remote mode will also automatically be enabled.

- d. Keep pressing the **Back** button to save the settings and return to the Main screen.

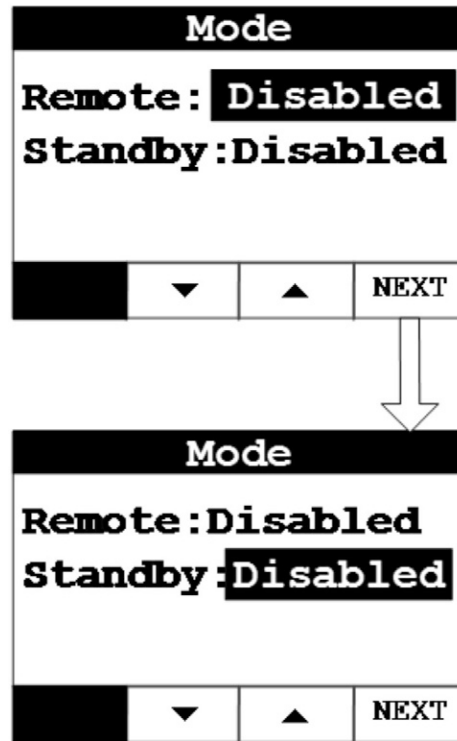

FIGURE 9. MODE SETUP SCREEN (LOCAL DISPLAY)

2. To enable or disable the Standby mode on the **REMOTE** display:

NOTICE

Remote must be enabled before Standby mode can be changed from the Remote display. If Remote mode is not enabled, Standby will remain disabled and cannot be changed.

- a. From any screen, select the **Mode** key to get to the Mode screen.
- b. Use the arrow keys to enable or disable the Standby mode.
- c. Keep pressing the **Back** button to save the settings and return to the Main screen.



FIGURE 10. MODE SETUP SCREEN (REMOTE DISPLAY)

Remote Monitoring System (RMS) Description

Introduction

The Remote Monitoring System (RMS) feature allows for in-home or remote access to your generator set through a web page or smart phone app. Using the RMS, you can start or stop the generator set, adjust the exerciser date and time, determine if utility power is available, and view the last 20 events and/or faults on the generator set. This feature can also help to reduce troubleshooting time and the number of service calls if a generator service provider has access to the same information.

The RMS website is <https://connectcloud.cummins.com>.

The internet interface can make the same fault, maintenance, and event notifications available to you and to your generator set service provider if you link your account with a dealer.

RMS is optional. If you do not wish to use this service or do not have an Ethernet connection available, you are not required to set up an RMS account.

NOTICE

RMS requires an active internet connection at your generator set in order to provide accurate information and notifications. In order to ensure no RMS information or notifications are missed, Cummins recommends an uninterruptible power supply (UPS) for your home modem/router to prevent any loss of internet connection during a power outage.

NOTICE

Technical support for setup and troubleshooting of the RMS is available through the selling Cummins dealer/distributor. However, due to variations in network equipment, network configurations, and internet and cellular service providers, the owner may be required to contact their Internet Service Provider or cellular service provider for technical support regarding internet connectivity and smart phone applications support. Cummins does not provide technical support for the setup and troubleshooting of the owner's network and cellular service.

NOTICE

The following Internet browsers are compatible with this option:

- Microsoft Internet Explorer® (version 9 or greater)
- Apple Safari®
- Google Chrome™
- Mozilla Firefox® (version 3.6 or greater)
- Microsoft® Edge

RMS Customer Account Setup and Generator Set Control Connection

The following instructions for setting up an account and the generator set control connection are for customers only.

1. Prior to setting up the new customer account, make sure that the generator set control is connected to the Internet via an Ethernet cable between the generator set control and your home router.
2. To access the generator set control, open the generator cover and remove the right side control access panel.
3. Route the ethernet cable into the generator set through the right side of the enclosure. Then route and secure the ethernet cable above the intake manifold along with the other customer wiring connections.
4. Ensure the ethernet cable is securely inserted into the generator set control.

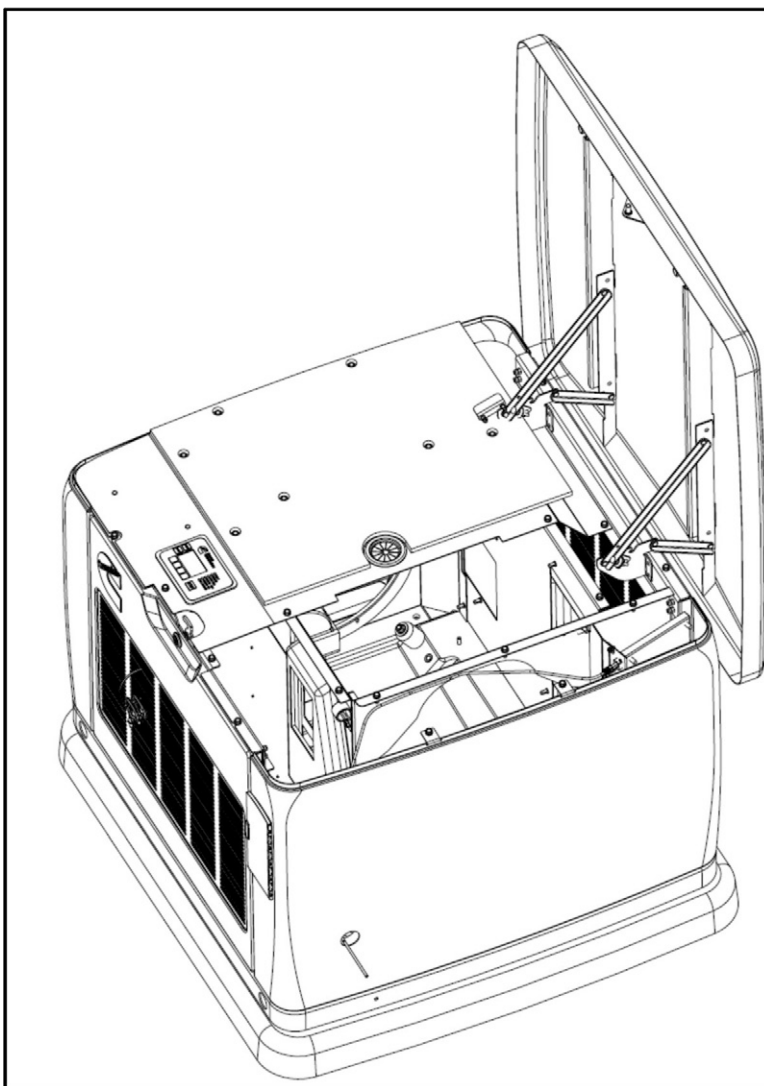

FIGURE 11. ETHERNET CABLE ROUTING

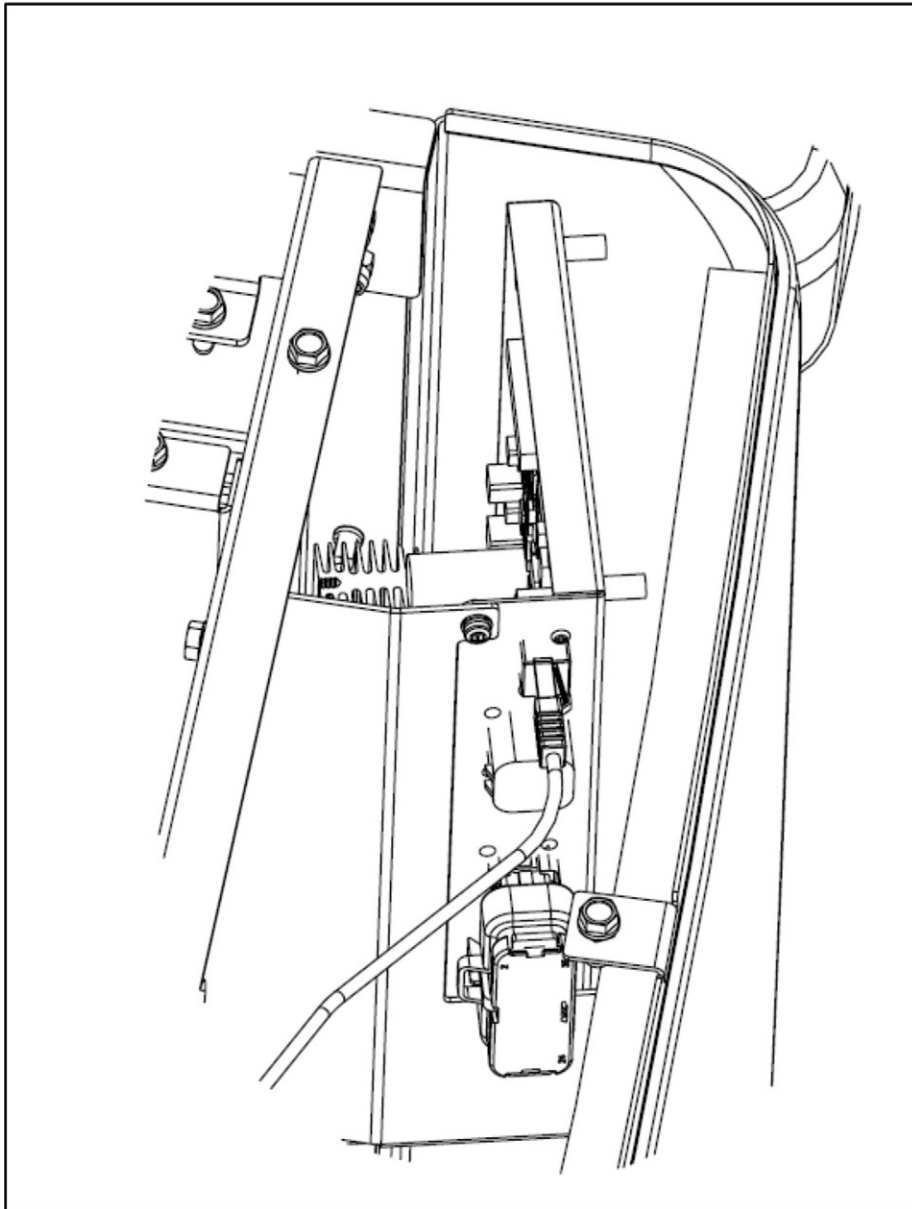

FIGURE 12. ETHERNET PORT ON GENERATOR CONTROL

5. The ethernet cable needs to be rated for 300V if it is routed through the same conduit as the AC load cables.
6. From the control, verify that your generator set has cloud connectivity on the Cloud Info screen on the display by pressing **Menu => Next => About => Next => Next**.
7. From a computer device, access the Cummins ConnectCloud website by navigating to <https://connectcloud.cummins.com/>.
8. Click on the **Register** button to start the registration process.
9. Agree to the terms of service by scrolling down to the bottom of the page and checking the box next to "I have read and accept the terms of service".

10. Click on the **Accept** button.
11. Enter your email address. Click the **Send Verification Code** button.
12. Check your email for the verification code and enter it in the **Verification code** field.
13. Click the **Verify Code** button.
14. Create a new password.
15. Enter your first name and last name.
16. Click on the **Create** button.
17. Complete the required (*) fields on the Setup New Generator page:
 - a. Enter the contact information for the location.
 - b. Enter the Serial Number and Customer Access Code:
 - i. Find the Serial Number and Customer Access Code on the generator set's control display by pressing **Menu** => **Next** => **About** => **Next**. The About Genset screen will appear on the display.
 - c. Click on the "I'm not a robot" box and follow the directions.
 - d. Click on the **Continue** button.

If your generator set has an active Internet/cloud connection and your serial number and customer access code are correct, and the generator set is not already linked to another account, a message will appear on the screen that says, "Your device has been located".

NOTICE

Communications on the network must be open to 168.61.54.255 on port 8884 and 40.114.00.153 on port 8885.

18. *Optional:* Link your account to your local dealer. If you do not see your dealer in the list, it is possible the dealer has not yet registered themselves as a dealer on the Cummins Connect Cloud; in this case, contact the dealer.

NOTICE

You can add or change your dealer at any time.

19. *Optional:* After you have registered and accessed your home page, add additional users or generator sets to your account by navigating to Preferences, My Generators, or Manage Users.

NOTICE

Android and iPhone applications for the Cummins ConnectCloud are also available. Using a mobile application will enable you to receive status and warning notifications.

3.2 Generator Set Status

"About" Screen

To retrieve information about the display:

1. From the Main screen, select **Menu**.
2. Use the arrow keys to highlight **About**. Select the **Enter** key.

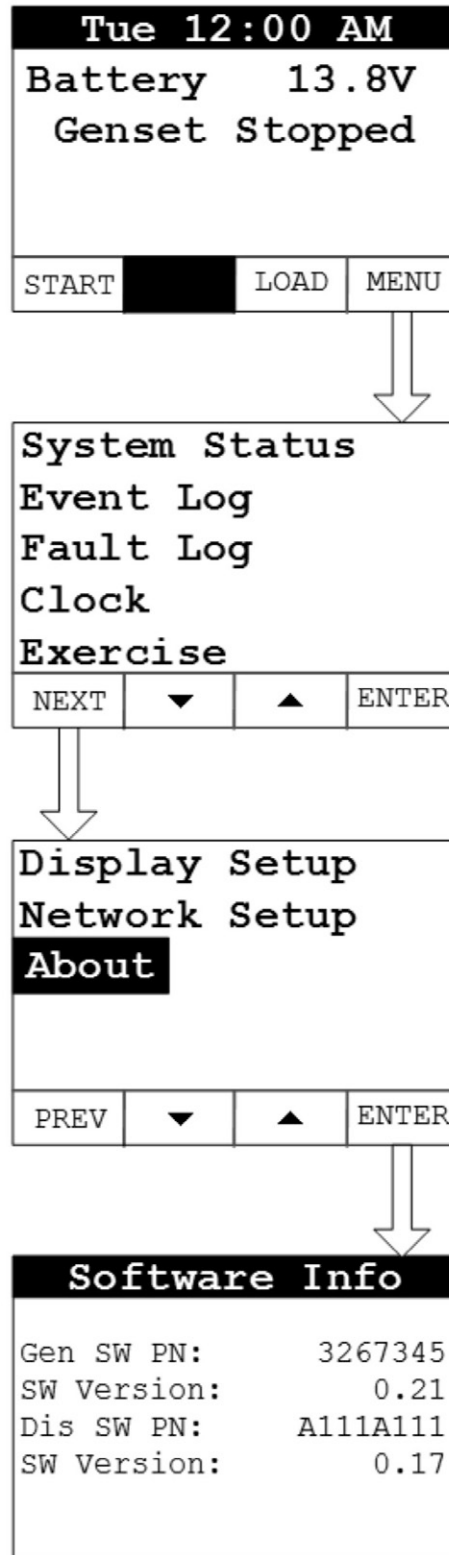

FIGURE 13. ABOUT SCREEN

"Event Log" Screen

To retrieve information from the Event Log:

1. From the Main screen, select **Menu**.
2. Use the arrow keys to highlight **Event Log**. Select the **Enter** key.
3. Use the arrow keys to navigate through the Event Log.
4. Keep pressing the **Back** button to return to the Main screen.



FIGURE 14. EVENT LOG SCREEN

"Fault Log" Screen

To retrieve information from the Fault Log:

1. From the Main screen, select **Menu**.

2. Use the arrow keys to highlight **Fault Log**. Select the **Enter** key.
3. Scroll through the fault log using the up and down double-arrows. Each screen provides a brief description of the fault, the fault code number, the engine hours and the time and date of the fault.

NOTICE

If there are no faults recorded, the "No Stored Faults" screen will appear.

4. Keep pressing the **Back** button to return to the Main screen.



FIGURE 15. FAULT LOG SCREEN

"System Status" Screen

To retrieve system status:

1. From the Main screen, select **Menu**.
2. Use the arrow keys to highlight **System Status**. Select the **Enter** key.
3. Keep pressing the **Back** button to return to the Main screen.



FIGURE 16. SYSTEM STATUS SCREEN

This page is intentionally blank.

4 Operation

4.1 Safety Considerations

WARNING

Hazardous Voltage

Contact with high voltages can cause severe electrical shock, burns, or death.

Make sure that only personnel who are trained and qualified to work on this equipment are allowed to operate the generator set and perform maintenance on it.

WARNING

Automated Machinery

Accidental or remote starting of the generator set can cause severe personal injury or death.

Make sure that the generator set cannot be started accidentally or remotely before starting work on the generator.

WARNING

Combustible Gases

Ignition of battery gases is a fire and explosion hazard which can cause severe personal injury or death.

Do not smoke, or switch the trouble light ON or OFF near a battery. Touch a grounded metal surface first before touching batteries to discharge static electricity. Stop the generator set and disconnect the battery charger before disconnecting battery cables. Using an insulated wrench, disconnect the negative (-) cable first and reconnect it last.

CAUTION

Hazardous Voltage

Contact with high voltages can cause severe electrical shock, burns, or death.

Isolate all external electrical supplies prior to access of the control panel. Internal components have live exposed terminations even when the generator set is not running.

NOTICE

Always disconnect a battery charger from its AC source before disconnecting the battery cables. Failure to do so can result in voltage spikes high enough to damage the DC control circuits of the generator set.

NOTICE

Ventilate the battery area before working on or near the battery. Wear goggles. Stop the generator set and disconnect the battery charger before disconnecting the battery cables using an insulated wrench. Disconnect the negative (-) cable first and reconnect it last.

All maintenance tasks must be assessed for health and safety risks; the preventive measures identified must be performed. An additional person is required for any task where doing so significantly adds to the safety of the task.

The installation of a generator set can be designed for remote starting. When troubleshooting a generator set that is shut down, make sure that the generator set cannot be accidentally re-started. Refer to the Locking the Generator Set Out of Service section.

4.2 Introduction

This section describes the operation of the generator set. The text should be read in conjunction with the Control System section of this manual.

All indicators, control switches/buttons, and graphical display are located on the face of the local and remote displays.

⚠ CAUTION

To avoid injury, be sure to read the instructions in the Operating the Generator Set Cover Safely section before lifting the generator set cover.

4.3 Maintenance

To ensure maximum performance and reliability from your generator set, it is essential that certain components are inspected periodically and, where necessary, maintenance procedures are carried out, as detailed in the Maintenance chapter.

4.4 Generator Set Operation

⚠ WARNING***Combustible Vapors***

Do not operate a generator set where there are or can be combustible vapors.

These vapors can be sucked through the air intake system and cause engine acceleration and overspeeding, which can result in a fire, an explosion, personal injury and extensive property damage.

Correct care of your generator set will result in longer life, better performance, and more economical operation.

Cummins does not know how you will use your generator set. The equipment owner and operator, therefore, is responsible for safe operation in the installation site environment. Consult your authorized Cummins service provider for further information.

Sequence of Operation

NOTICE

The following sequences are based on an approximate time duration. Your generator set may vary slightly from the timing diagrams in this manual. All referenced times are based on default control settings. The following sequences are applicable to generator sets connected to a single phase RA series transfer switch.

Auto Start Sequence (with an RA Series Transfer Switch)

NOTICE

Standby Mode must be enabled for Auto Start to execute.

In normal operation, utility power is provided through the transfer switch to the building loads; the generator set is not running.

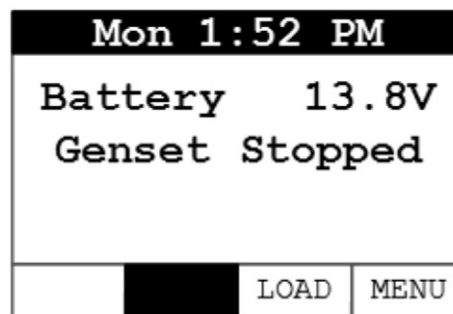

FIGURE 17. GENSET STOPPED

If utility power is not available (that is, there is a power outage), the following sequence will be executed to connect building load to the generator set, and then reconnect building load back to the utility power when it is available.

1. The generator set starts.

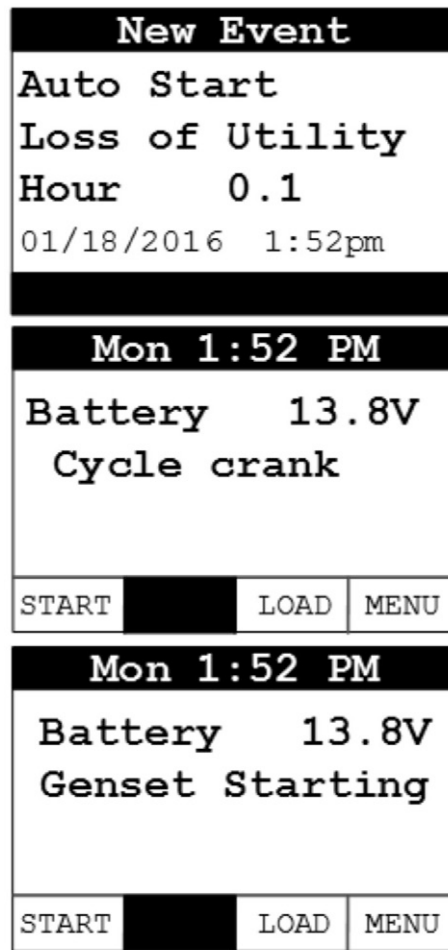

FIGURE 18. GENSET STARTING

2. After the generator set reaches rated voltage and frequency, the transfer switch transfers the building load to the generator set. The building's electrical power is now provided by the generator set.

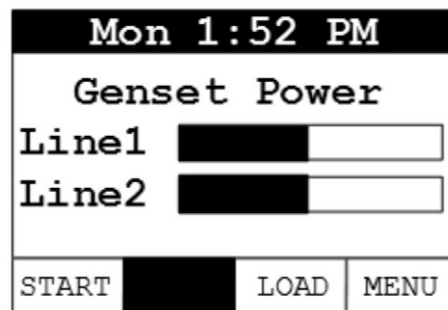
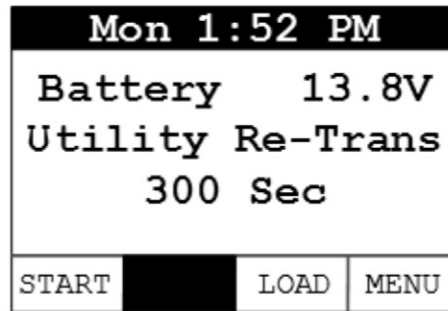
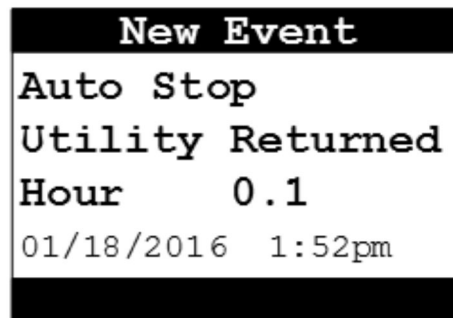

FIGURE 19. GENSET POWER

3. When utility power is restored, the sequence to transfer building load to the utility begins.
4. The generator set continues to run and waits for utility power to stabilize.

**FIGURE 20. UTILITY RE-TRANS**

5. When utility power is stable for 5 minutes, the transfer switch connects the building load back to utility power.

**FIGURE 21. UTILITY RETURNED**

6. The generator set runs an additional 5 minutes to cool down and then shuts off.

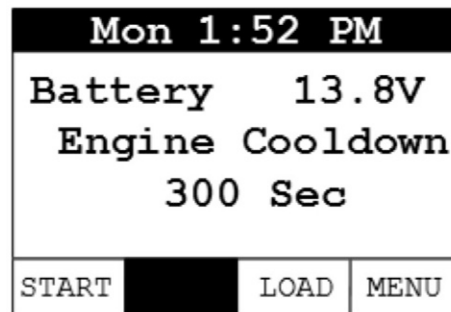
**FIGURE 22. ENGINE COOLDOWN**

7. Normal operation resumes. See [Figure 17](#).

Exercise Sequences

1. **Standard Exercise sequence:**

NOTICE
Standby Mode must be enabled for standard exercise to execute.

NOTICE

While the generator set is exercising, the building load remains connected to the utility; it is not transferred to the generator set.

The following steps will be executed when the programmed exercise day and time are reached or the Exercise Now option is selected and the standard exercise sequence is run:

- a. The generator set starts.

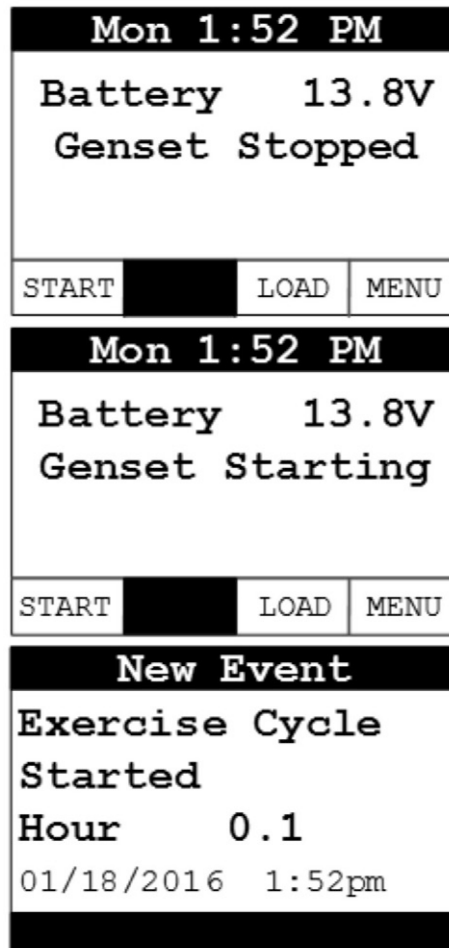
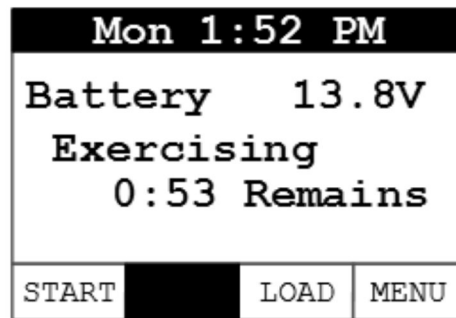
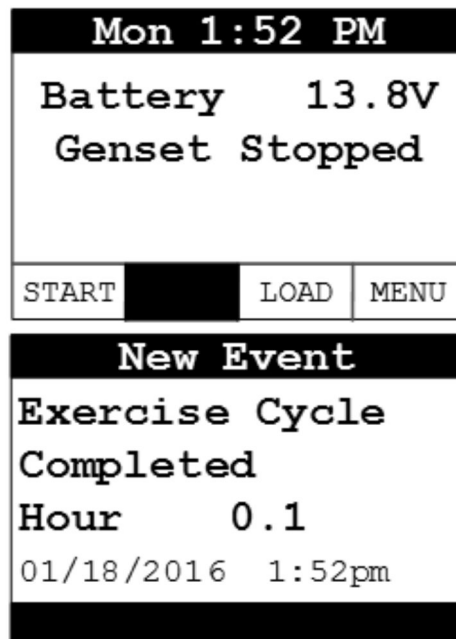

FIGURE 23. EXERCISE CYCLE STARTED

- b. After the generator set reaches rated speed and voltage, the exercise timer is started.

**FIGURE 24. EXERCISING**

- c. When the defined exercise time has completed, the generator set stops and normal operation resumes.

**FIGURE 25. EXERCISE CYCLE COMPLETED**

2. Crank Only Exercise Sequence

NOTICE

Standby Mode must be enabled for Crank Exercise to execute.

When Crank Exercise is enabled, the generator set will alternate between crank only exercise and standard (that is, generator set running) exercise sequences.

The following steps will be executed when the programmed exercise day and time are reached or the Exercise Now option is selected and the crank only exercise sequence is run:

- The generator set engine starter engages and rotates the engine, but the engine does not start.

- b. The generator set engine starter cranks for 8 seconds, rests for 15 seconds, and cranks another 8 seconds if the generator set control has not verified the information it is monitoring. Depending on the outcome of this sequence, either a shutdown fault message is issued or normal standby operation resumes.

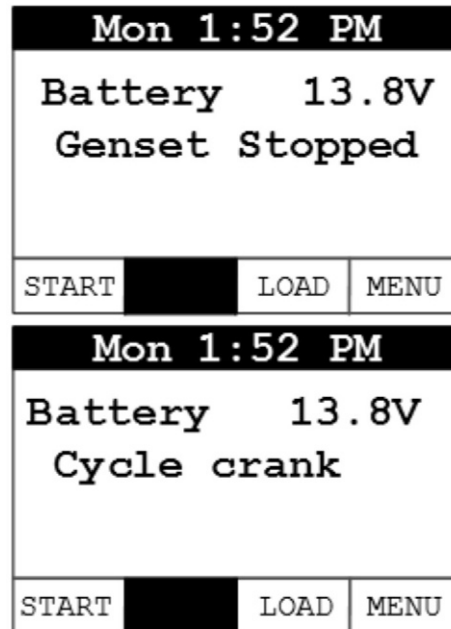

FIGURE 26. CYCLE CRANK

4.5 Manual Start Sequence (Local)

NOTICE
<p>If the utility power supply to the generator set's utility powered battery charger is interrupted, the battery can become discharged due to parasitic loads and the generator set may not start when needed. Whenever utility power is interrupted and the generator set is not in Standby mode for any reason (fuel preservation, etc.), start and run the generator set for 2 hours every 24 hour period when temperatures are <i>above</i> 50 °F (10 °C), or every 9 hour period when temperatures are <i>below</i> 50 °F (10 °C).</p>

The following steps will be executed when Manual Start is used at the local display:

1. If you do not want the ATS to transfer load to the generator set, open the generator set mounted circuit breaker when doing a manual start.
2. From the Main screen, select the **START** key.
3. A second screen appears notifying the operator that Standby will be disabled. Select the **START** key again to start the generator set.

4. After the generator set reaches rated voltage and frequency, the transfer switch transfers the building load to the generator set (unless the circuit breaker on the generator set is "off"). The building's electrical power is now provided by the generator set.

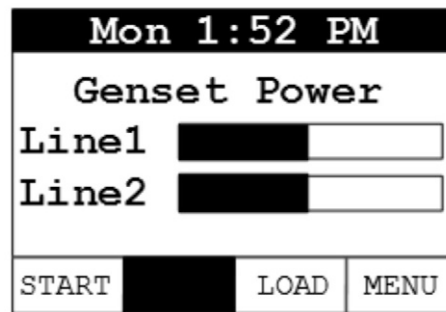

FIGURE 27. GENSET POWER

4.6 Manual Stop Sequence (Local)

The following steps will be executed when Manual Stop is selected at the Local display:

1. Press the red **STOP** button on the local display. The generator set will stop immediately and the building load will be transferred to the utility.
2. For normal operation to resume, Standby will need to be enabled. See the section on enabling Standby Mode.

NOTICE

The red **STOP** button on the Local display, when pressed, will cause both Remote and Standby Modes to be disabled.

4.7 Manual Start/Stop Sequence (Remote)

Remote mode must be enabled on the local display to allow manual start and stop from the Remote display. The manual start and stop sequences are the same for the Remote display and the Local display.

NOTICE

The red **STOP** button on the Remote display, when pressed, will cause the Standby Mode to be disabled.

4.8 "Fault" and "New Event" Screens

Various fault and event screens may appear on the operator display.

"FAULT" SCREEN

If a generator set fault occurs that will stop the generator set, the red FAULT light illuminates and a Fault message appears. The screen shows the Fault Code (FC) number, a brief description of the fault, current engine hours and the time and date of the fault.

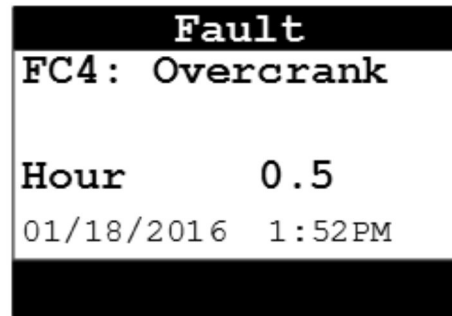

FIGURE 28. TYPICAL FAULT SCREEN

Press the **BACK** button to reset the fault and return to the home screen. The red FAULT light will shut off.

See the "Fault Log" Screen section of this manual for instructions on viewing the log of the last 20 faults.

"NEW EVENT" SCREEN

A New Event screen appears whenever the system status changes. The screen provides a brief description of the event, the current engine hours, and the date and time of the event. The message remains displayed unless superseded by a new event, or the **BACK** button is pressed.

1. Operation Events:

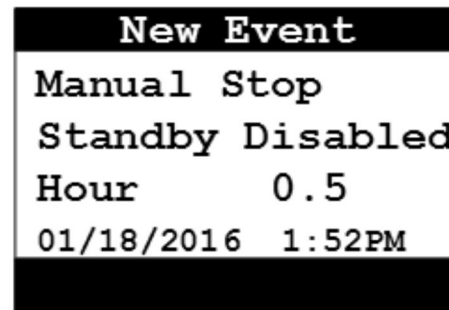

FIGURE 29. MANUAL STOP – STANDBY DISABLED

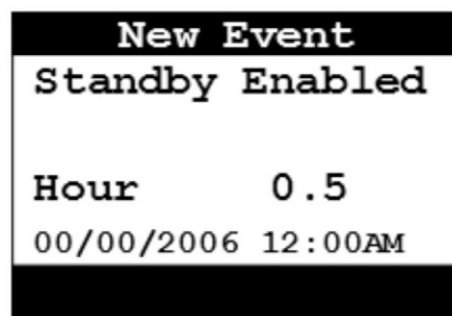

FIGURE 30. STANDBY ENABLED

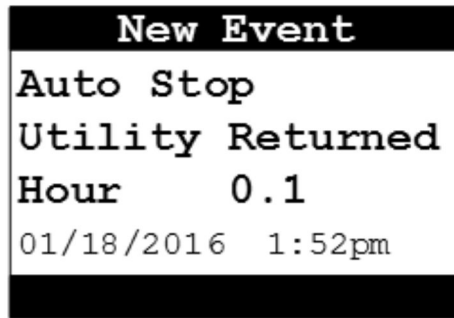

FIGURE 31. AUTO STOP – UTILITY RETURNED

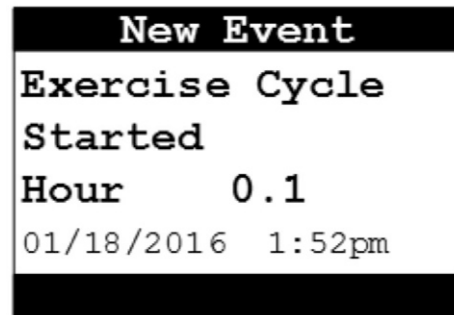

FIGURE 32. EXERCISE CYCLE STARTED

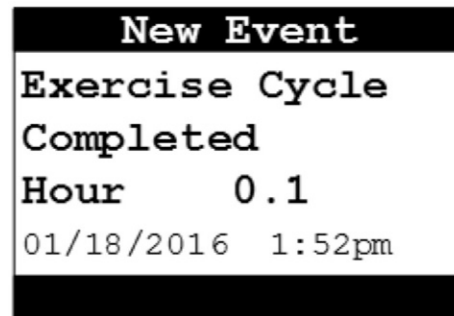

FIGURE 33. EXERCISE CYCLE COMPLETED

2. Maintenance and Service Events:

NOTICE
When a maintenance or service event occurs, the New Event screen will display and the display's yellow service light will turn on.

NOTICE
Refer to the Periodic Maintenance Schedule section for more information.

New Event
Scheduled Maint See Manual Hour 300.0 01/18/2016 1:52PM

FIGURE 34. SCHEDULED MAINTENANCE REMINDER EXAMPLE

New Event
Warning: Low Battery Voltage Hour 0.5 01/18/2016 1:52PM

FIGURE 35. LOW BATTERY VOLTAGE WARNING

New Event
Warning: Low Oil Level Hour 0.5 01/18/2016 1:52PM

FIGURE 36. LOW OIL LEVEL WARNING

Press the **BACK** button to return to the home screen and turn off the light (if lit).

See the "Event Log" Screen section of this manual for instructions on viewing the list of the last 20 events.

4.9 Automatic Load Management

NOTICE
The capability to automatically add or remove specific electrical loads from the generator set requires that load management devices be wired to the generator set load management outputs.

When the generator set is started automatically in Standby mode due to a loss of utility or manually by the operator, the control will energize all four load management outputs, disconnecting the associated loads from AC power. Once the transfer switch transfers to generator set power, the generator set control will evaluate the total load on the generator set versus a set point programmed into the control (80% of rated).

If the generator set's total load is below the set point, the generator set control will sequentially add the highest priority managed load every three minutes. Managed loads will continue to be added as long as the size of the next priority load to be added won't increase total generator set load above the set point. The control measures and stores the size of each managed load in its memory. Load priorities are in the following order:

- Priority #1: load control 1
- Priority #2: load control 2
- Priority #3: load control 3
- Priority #4: load control 4

If the load on the generator set is reduced at any time to below the set point, the control will add the next highest priority managed load in three minutes provided it does not increase the total generator set load above the set point.

If the load on the generator set exceeds 95% of its rating, the generator set control will begin disconnecting the lowest managed priority loads in sequence every second until the load on the generator set is below 95% of its rating.

Priority #1 load is always the first added and the last disconnected; therefore, it should be wired to the managed load deemed most critical to the homeowner. Priority #2 load cannot be added before priority #1 load, nor can it be disconnected before priority #3 or #4, etc.

This page is intentionally blank.

5 Maintenance

5.1 Maintenance Safety

 **WARNING**

Automated Machinery

Accidental or remote starting of the generator set can cause severe personal injury or death.

Isolate all auxiliary supplies and use an insulated wrench to disconnect the starting battery cables (negative [-] first).

 **WARNING**

Hydrogen Gas

Arcing can ignite explosive hydrogen gas given off by batteries, causing severe personal injury or death. Arcing can occur when cables are removed or replaced, or when the negative (-) battery cable is connected and a tool used to connect or disconnect the positive (+) battery cable touches the frame or other grounded metal part of the generator set.

Insulated tools must be used when working in the vicinity of the batteries. Always remove the negative (-) cable first and reconnect last.

 **WARNING**

Explosive Fumes

Arcing can ignite explosive fumes causing severe personal injury or death.

Make sure hydrogen from the battery, engine fuel and other explosive fumes are fully dissipated before working on the generator set.

 **WARNING**

Working at Heights

Using the incorrect equipment when working at heights can result in severe personal injury or death.

Suitable equipment for performing these tasks must be used in accordance with the local guidelines and legislation. Failure to follow these instructions can result in severe personal injury or death.

⚠ WARNING**Access**

Using the generator set or part of as a means of access when attaching lifting shackles, chains, or other lifting aids, may damage the generator set, causing severe personal injury or death.

Do not use the generator set as a means of access. Failure to follow these instructions can result in severe personal injury or death.

⚠ WARNING**Exposed Terminations**

Some panel internal components may have live exposed terminations even if the generator set is not running. Voltages are present which can cause electrical shock, resulting in personal injury or damage to equipment.

Isolate all external electrical supplies prior to access of the control panel

NOTICE

Only authorized and qualified maintenance technicians who are familiar with the equipment and its operation should carry out maintenance.

NOTICE

Dependent upon the control system fitted, this unit may operate automatically and could start without warning.

NOTICE

Always disconnect a battery charger from its AC source before disconnecting the battery cables. Failure to do so can result in voltage spikes high enough to damage the DC control circuits of the generator set.

All maintenance tasks must be performed, but be sure to assess them for health and safety risks before starting. For example, perform a task with someone present if doing so will add significantly to the safety of the task.

Read, understand, and comply with all Caution, Warning, and Danger notes in this section, the Important Safety Instructions section, and the documentation supplied with the generator set.

Make sure that adequate lighting is available.

Locking the Generator Set Out of Service

Before any work is carried out for maintenance, etc., the generator set must be immobilized. Even if the generator set is put out of service by pressing the red STOP button on the local display, the generator set cannot be considered safe to work on until the generator set is properly immobilized, as detailed in the following procedure.

To immobilize the generator set:

1. Press the generator set's red STOP button on the local display to stop the generator set. Allow the generator set to thoroughly cool to the touch.
2. Thoroughly ventilate the generator set before disconnecting any leads.
3. Turn off and disconnect any AC powered devices at the generator set, such as oil heater, battery heater, and battery charger before disconnecting the battery cables.
4. De-energize and lock off any utility power to the generator set.
5. Turn off the fuel supply to the generator set.
6. Disconnect the negative (–) cable from the battery and secure it from contacting the battery terminals to prevent accidental starting or electrical arcing at the battery.
7. Place warning notices at each of the above locations that state, "Maintenance in Progress – Immobilized for Safe Working."

5.2 Periodic Maintenance

WARNING

Electrical Generating Equipment

Accidental or remote starting of the generator set can cause severe personal injury or death.

Before working on the generator set, make sure that the generator set is in Off mode, disable the battery charger, and remove the negative (–) battery cable from the battery to prevent starting.

The table(s) that follow show the recommended service intervals for a generator set on standby service. If the generator set will be subjected to extreme operating conditions, the service intervals should be reduced accordingly.

At each scheduled maintenance interval, perform all previous maintenance checks that are due for scheduled maintenance.

Some of the factors that can affect the maintenance schedule are:

- Extremes in ambient temperature
- Exposure to elements
- Exposure to salt water
- Exposure to windblown dust or sand

Consult with your authorized Cummins service provider if the generator set will be subjected to any extreme operating conditions, and determine if extra protection or a reduction in service intervals is needed. Use the engine hours shown on the system status screen to keep an accurate log of all service performed for warranty support. Perform all service at the time period indicated, or after the number of operating hours indicated, whichever comes first.

Repair or replace worn, damaged, or improperly functioning components identified during periodic maintenance procedures.

Periodic Maintenance Guidelines

Regularly performing the following periodic maintenance tasks greatly reduces the chances of a generator set shutdown:

- Maintain an appropriate oil level.
- Keep battery connections clean and tight.
- Do not overload the generator set.
- Keep the air inlet and outlet openings clear.

Periodic Maintenance Schedule

Periodic maintenance is essential for top generator set performance. Use the Maintenance Frequency table below as a guide for normal periodic maintenance.

- In hot and dusty environments, some maintenance procedures should be performed more frequently, as indicated by the footnotes in the table.
- Maintenance, replacement or repair of emission control devices and systems may be performed by any engine repair establishment or individual.
 - Warranty work **MUST** be completed by your authorized Cummins Inc. service provider.

WARNING

Automatic startup of the generator set can cause severe personal injury or death. Make sure the generator set is shut down and disabled:

- 1. Press the generator set's red STOP button on the local display to stop the generator set. Allow the generator set to thoroughly cool to the touch.***
- 2. Turn off and disconnect the battery charger from the AC source before disconnecting the battery cables.***
- 3. Disconnect the negative (-) cable from the battery and secure it from contacting the battery terminals to prevent accidental starting.***

NOTICE

Perform all service at the time period indicated, or after the number of operating hours indicated, whichever comes first.

TABLE 11. MAINTENANCE FREQUENCY

Maintenance Task	Maintenance Frequency				
	First 25 Hours and 100 Hours	Every 24 Hours	Every 24 Hours or 6 Months	Every 200 Hours	Every 2 Years
Check Engine Oil Level		■ ^{2, 3}			
Change Engine Oil and Oil Filter	■			■ ⁴	■ ⁴
Adjust Engine Valve Clearance	■ ^{1, 6}			■ ^{1, 6}	
Replace Engine Air Filter				■ ⁴	■ ⁴
Clean and Check Starting Battery				■	
Clean Slip Rings			■ ⁷		
Complete System Test				■ ^{5, 6}	■ ^{5, 6}

1. Perform sooner if engine performance deteriorates.
2. Perform more often when operating in high temperature conditions.
3. Check daily during power outages, or monthly without power outages.
4. Perform more often when operating in dusty conditions.
5. See the automatic transfer switch manual for testing of load transfer.
6. Must be performed by a qualified service technician (authorized Cummins Inc. service provider).
7. Clean slip rings with an approved tool, 3M Scotch Bright pads Maroon (Grit Equiv. 360-400) OR 3M Three-M-ite 400 grit cloth.

A "New Event" screen appears and the yellow service LED turns on whenever one of the following scheduled maintenance time periods occurs:

1. First 25 hours of generator set running
2. First 100 hours of generator set running
3. After the first 100 hours, every 200 hours of generator set running

Press the **BACK** button to turn off the light and return to the home screen.

See the "Fault" and "New Event" Screens section for more information.

Maintenance Record

Record all periodic and unscheduled maintenance and service. See the Periodic Maintenance Schedule for a list of scheduled maintenance frequency.

The generator set exerciser mode defaults are as follows.

- **Day:** Tuesday
- **Time:** 2:00 pm
- **Period:** Monthly
- **Run Time:** 5 minutes

Refer to the Exercise Settings section of this manual for more information on setting up the exerciser.

Maintenance Procedures - Daily or When Refueling

Monitor fluid levels, oil pressure, and coolant temperature frequently. During operation, be alert for mechanical problems that could create unsafe or hazardous conditions. The following sections cover several areas that should be frequently inspected for continued safe operation.

NOTICE

Components that have guards against inadvertent touching must be visually inspected only. Do not remove the guards to do the inspection.

General Information

Preventive maintenance begins with day-to-day awareness of the condition of the generator set. Before starting the generator set, check and look for:

- Oil and coolant levels
- Leaks
- Loose or damaged parts
- Worn or damaged belts
- Any change in engine noise or performance
- Generator set appearance

Engine Operation Report

The engine must be maintained in good mechanical condition if the operator is to obtain optimum satisfaction from its use. Running reports are necessary to enable programmed or emergency servicing to be carried out.

Comparison and intelligent interpretation of the running report, together with a practical follow-up action will eliminate most failures and emergency repairs.

Most engine problems give an early warning. Look and listen for changes in engine performance, sound, or appearance that can indicate service or repair is needed. Some engine changes to look for and report on are:

- Low lubricating oil pressure
- Low power
- Abnormal water or oil temperature

- Unusual engine noise
- Excessive use of coolant, fuel or lubricating oil
- Any coolant, fuel, or lubricating oil leaks
- Misfire
- Unexplained frequency fluctuation
- Significant vibration
- Excessive white and/or black exhaust smoke.

5.3 Engine Oil

Recommended Engine Oil

Check the oil level prior to starting the generator set to verify that the oil level is between the High and Low marks.

The generator set is shipped with 0W30 synthetic engine oil. Refer to the Model Specification section for the oil specification.

Checking Engine Oil Level

WARNING

State and federal agencies have determined that contact with used engine oil can cause cancer or reproductive toxicity. Avoid skin contact and breathing of vapors. Use rubber gloves and wash exposed skin.

WARNING

Automated Machinery

Accidental or remote starting of the generator set can cause severe personal injury or death.

The generator set must be off and locked out of service whenever the air inlet, air outlet, or any interior panels, are removed.

WARNING

Crankcase pressure can blow out hot oil and cause severe burns. Do NOT check oil while the generator set is operating.

NOTICE

Check the engine oil level when the generator set is not running and is out of Remote mode.

NOTICE

Overfilling can cause foaming or aeration of the oil, and operation below the low mark may cause loss of oil pressure. Do not operate the generator set with the oil level below the low mark or above the high mark.

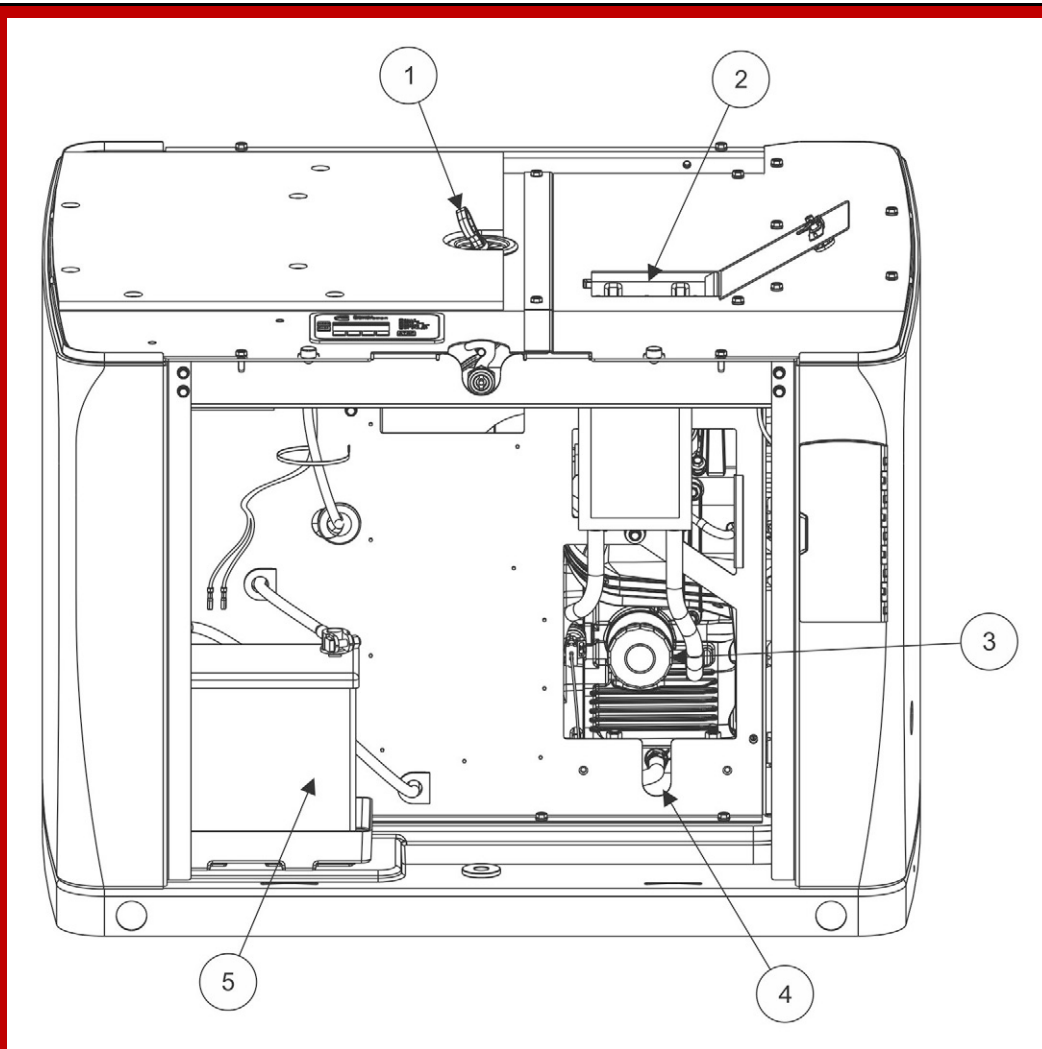

No.	Description	No.	Description
1	Engine Oil Level Dipstick	4	Engine Oil Drain Hose
2	Engine Oil Fill	5	Battery
3	Engine Oil Filter		

FIGURE 37. ENGINE OIL COMPONENTS (SIDE VIEW)

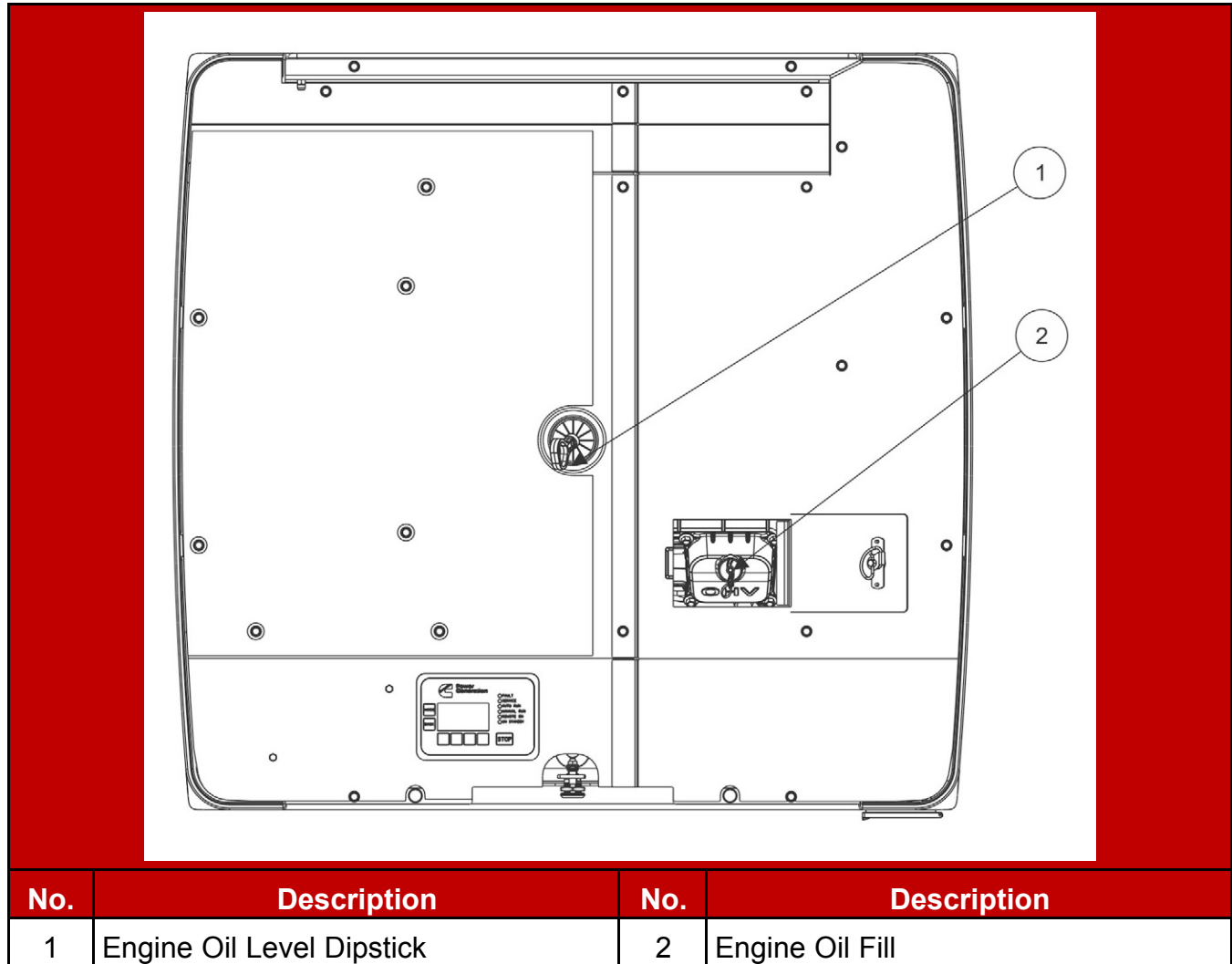

FIGURE 38. ENGINE OIL COMPONENTS (TOP VIEW)

To check the engine oil level:

1. Make sure that the generator set has not been running for approximately five minutes.
2. Clean off the area surrounding the dipstick port and prevent debris from entering the engine.
3. Pull out the dipstick and wipe it clean.
4. Reinsert and fully seat the dipstick.
5. Remove the dipstick and check the oil level.
6. Reinsert and fully seat the dipstick.

If the engine oil level check shows excessive or insufficient levels of oil (oil level line above the High mark or below the Low mark), oil must be drained or added. Refer to the following sections for instructions and guidelines for draining and adding oil.

Adding or Draining Oil

WARNING

Hot Surfaces

Contact with hot surfaces can cause severe burns. Wear appropriate PPE when working on hot equipment and avoid physical contact with hot surfaces.

WARNING

Hot Engines

Contact with hot engines can cause severe burns. Ensure that the generator set engine has cooled down before adding or draining the oil.

NOTICE

Too much oil can cause high oil consumption. Too little oil can cause severe engine damage. Keep the oil level between the High and Low marks on the dipstick.

Adding Oil

If the oil level is found to be insufficient, oil must be added.

1. Ensure that the oil fill cap area is clean, and prevent debris from entering the engine.
2. Add the appropriate amount of oil, based on the engine oil level check. Refer to the Checking Engine Oil Level section and the Model Specifications section.
3. Recheck the engine oil level. Based on the results, add or drain oil.
4. Clean up and dispose of any oil in accordance with local/state regulations.

Draining Oil

If the oil level is found to be excessive, oil must first be drained from the engine.

1. Remove the access panels to get to the drain hose.
2. Place the end of the drain hose into an appropriate container.

NOTICE

Refer to local regulations to determine the appropriate container for used oil.

3. Open the oil drain cap at the end of the hose and the drain valve at the engine to release oil from the engine into the appropriate container.
4. Re-check the engine oil level. Based on the results, add or drain oil.

5. When a sufficient amount of oil has been drained from the system, close the drain valve at the engine and the oil drain cap on the hose.
6. Wipe the oil drain cap clean.
7. Re-install the access panels. Torque the fasteners 5.0–6.6 Nm (3.5–5.0 ft-lb).
8. Dispose of the used oil in accordance with local and state regulations.

Changing Engine Oil and Oil Filter

NOTICE

Automated Machinery

Accidental or remote starting of the generator set can cause severe personal injury or death.

Isolate all auxiliary supplies and use an insulated wrench to disconnect the starting battery cables, negative (–) cable first.

⚠ WARNING

Toxic Hazard

State and federal agencies have determined that contact with used engine oil can cause cancer or reproductive toxicity.

Avoid skin contact and breathing of vapors. Use rubber gloves and wash exposed skin.

NOTICE

If the oil and/or oil filter are not reused, dispose of them in accordance with local environmental regulations.

NOTICE

Change the engine oil and filter when the generator set is not running and is out of Remote mode.

NOTICE

Change the oil more often in hot and dusty environments.

NOTICE

Cummins highly recommends that any service or maintenance work be performed by qualified technicians.

1. Open the generator set's circuit breaker to prevent the ATS from transferring to generator set source when manually starting.
2. Before changing the oil, manually start the generator set.
3. Allow the generator set to run for 2 to 5 minutes to warm the engine oil.

4. Make sure the generator set is shut down and disabled:
 - a. Press the generator set's "O" (Off) button to stop the generator set. Allow the generator set to thoroughly cool to the touch.
 - b. Turn off and disconnect the battery charger from the AC source before disconnecting the battery cables.
 - c. Disconnect the negative (–) cable from the battery and secure it from contacting the battery terminals to prevent accidental starting.
 - d. If applicable, disconnect the oil heater from its AC power source (or turn off power).
5. Remove the access panels to get to the drain hose.
6. Open the oil drain cap at the end of the hose and the drain valve at the engine to release oil from the engine into the appropriate container.

NOTICE

Refer to local regulations to determine the appropriate container for used oil.

7. Close the drain valve at the engine and the drain cap on the hose.
8. Wipe the oil drain cap clean.
9. Place an appropriate container below the oil filter to collect oil as the filter is being removed.
10. Remove the oil filter by turning it counterclockwise.
11. Remove the old gasket if it remains on the engine.
12. Clean the filter mounting surface on the engine block.
13. Make sure the gasket is in place on the new filter and apply a thin film of clean oil to the gasket.
14. Install the new filter until the gasket just touches the block. Turn it an additional 1/2 to 3/4 turn. Do not over-tighten.
15. Remove the container used to collect oil when removing the oil filter.
16. Add the appropriate amount of oil.

NOTICE

Too much oil can cause high oil consumption. Too little oil can cause severe engine damage. Keep the oil level between the High and Low marks.

17. Check the engine oil level. Based on the results, add or drain oil.
18. Remove any oil that has spilled on the generator set during this procedure.
19. Make sure the generator set breaker is open.

20. Reconnect the cables and battery charger:
 - a. Reconnect the engine battery cables, positive (+) cable first.
 - b. Reconnect the battery charger to its AC power source.
21. Reconnect the oil heater AC power or energize its AC circuit.
22. Operate the generator set with no load for approximately 5 minutes to check for leaks at the oil filter or oil drain hose.
23. Shut down the generator set, wait 5 minutes, and then confirm that the correct oil level is in the pan.
24. Check for leaks and repair any that are identified.
25. Dispose of the used oil and oil filter according to local environmental regulations.
26. Re-install the access panels. Torque the fasteners 5.0–6.6 Nm (3.5–5.0 ft-lb).
27. Restore the original generator set settings.
28. Close the generator set breaker.

5.4 Normal Duty Air Cleaner Element Replacement

NOTICE

Cummins Inc. does not recommend cleaning paper-type air cleaner elements.

AIR CLEANER ELEMENT REMOVAL

1. Make sure the generator set is shut down and disabled:
 - a. Press the generator set's red STOP button on the local display to stop the generator set. Allow the generator set to thoroughly cool to the touch.
 - b. Turn off and disconnect the battery charger from the AC source before disconnecting the battery cables.
 - c. Disconnect the negative (–) cable from the battery and secure it from contacting the battery terminals to prevent accidental starting.

WARNING

Automatic startup of the generator set during maintenance can cause severe personal injury or death.

2. Remove the access cover to get to the air cleaner housing.
3. Wipe away any debris accumulated on the air cleaner housing.
4. Remove the two M6 pan head screws.

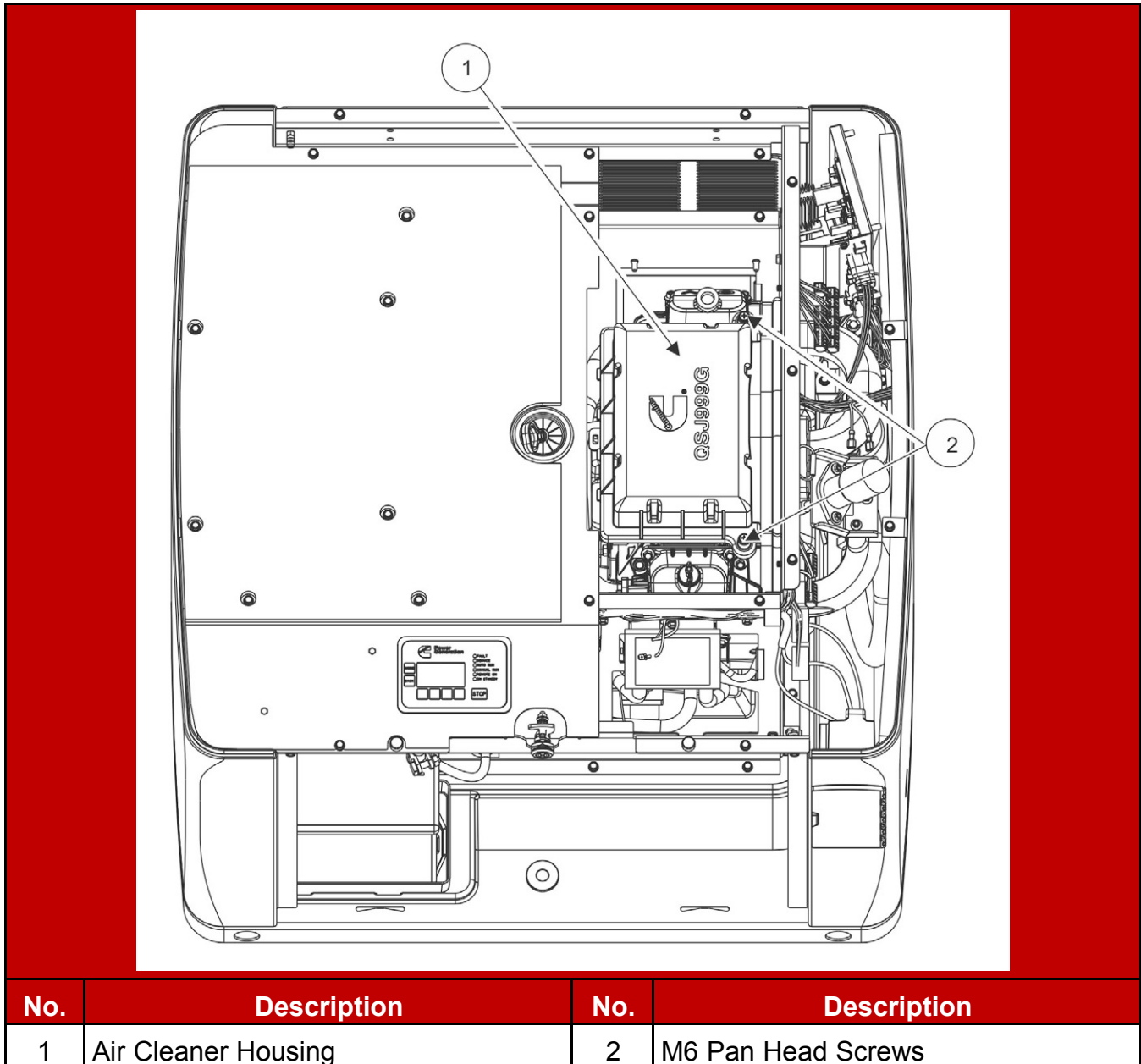

FIGURE 39. AIR CLEANER ELEMENT WITH PAN HEAD SCREWS

- Remove the top of the air cleaner housing which contains the air cleaner element. Ensure that no debris is allowed to enter the base of the air cleaner housing or the engine intake.

The housing is retained by the two M6 screws on one end and a series of slots and tabs on the other end. The following image shows the air cleaner element in the housing top, shown oriented as the housing top appears when it has been removed.

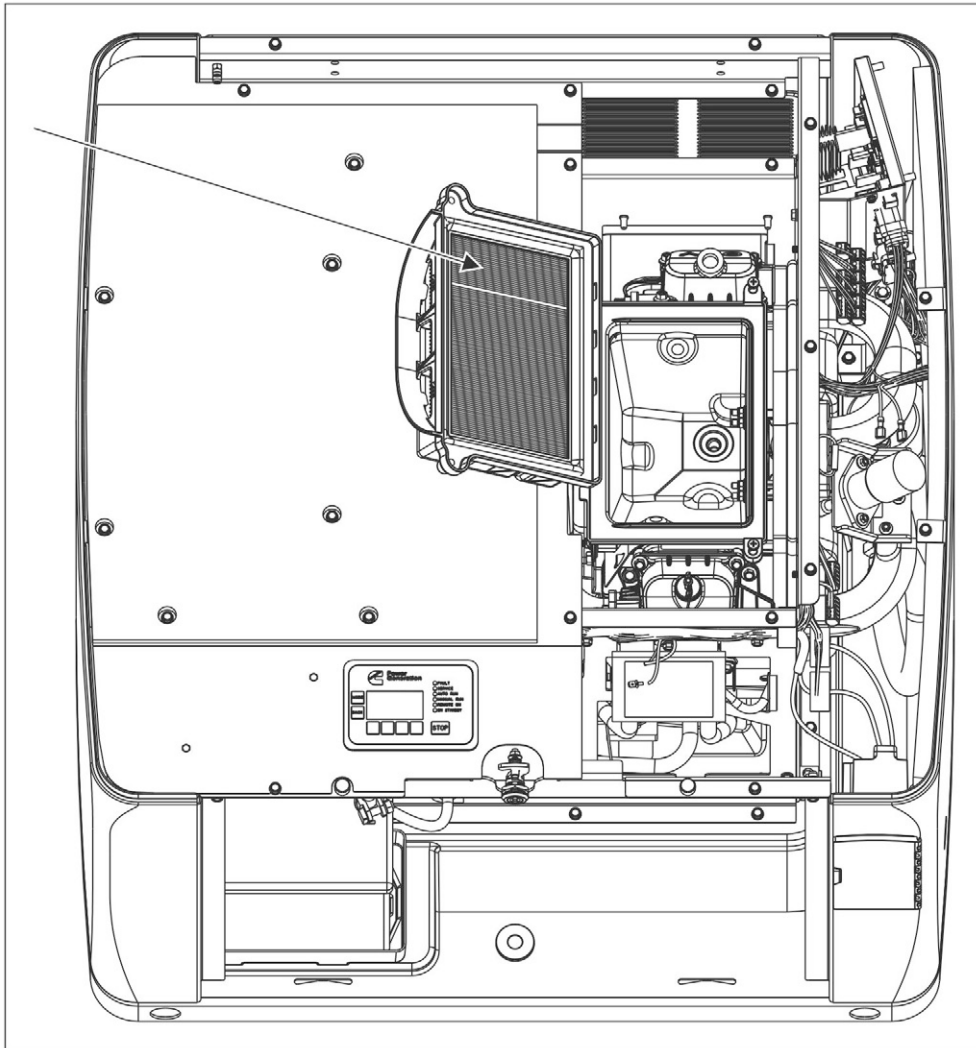

FIGURE 40. AIR CLEANER ELEMENT IN THE HOUSING TOP

6. Pull up on the fastener end of the housing top and slide it back to release it from the tabs.
7. Remove the dirty cleaner element.
8. Dispose of the dirty cleaner element in accordance with local environmental agency requirements.

AIR CLEANER ELEMENT INSTALLATION

1. Clean the gasket surface on the air cleaner housing base.
2. Place the new air cleaner element in the air cleaner housing top.
3. Push the element into the housing until its gasket is fully seated against the housing top.
4. Place the slots on the top over the tabs on the housing bottom, and rotate the cover to the seated position.
5. Install the two pan head screws into the housing base. Torque to 2.3 - 3.0 ft-lb (3.2 - 4 Nm).

6. Re-install the access panel and tighten the screws. Torque 3.5 - 5.0 ft-lb (5.0 - 6.6 Nm).
7. Reconnect the battery and restore the original generator set settings.

5.5 Batteries

Batteries are an essential part of any standby generator set system. A significant amount of generator set failures are due to battery issues.

It is therefore vital that batteries are stored, commissioned, and maintained as detailed here. Reference should also be made to the battery manufacturer's instructions.

Maintenance free batteries (if supplied with the generator set) need no maintenance for commissioning.

Storage

Batteries must be stored in a cool, dry, well-ventilated place, in the upright position, and with the vent caps securely in place.

Batteries must never be stacked on top of each other and must be protected from the floor by a wooden pallet or suitably thick cardboard sheet.

Safety Precautions

Servicing of batteries are to be performed or supervised by personnel knowledgeable of batteries and the required precautions. Keep unauthorized personnel away from batteries.

General Precautions for Maintenance-Free Batteries

Handling and proper use of batteries is not hazardous if the correct precautions are observed and personnel are trained in their use.

WARNING

Arcing Hazard

Laying tools or metal objects across the battery can cause arcing that may ignite battery gases causing explosions resulting in personal injury.

Never lay tools or metal objects across the top of the battery.

WARNING

Electric Shock Hazard

Voltages and currents present an electrical shock hazard that can cause severe burns or death.

Use tools with insulated handles to prevent the risk of electric shock.

⚠ CAUTION**Toxic Hazard**

Electrolyte is a dilute sulphuric acid that is harmful to the skin and eyes. It is electrically conductive and corrosive.

Wear full eye protection and protective clothing. If electrolyte contacts the skins, wash it off immediately with water. If electrolyte contacts the eyes, flush thoroughly and immediately with water and seek medical attention. Wash spilled electrolyte with an acid neutralizing agent.

NOTICE

Keep batteries upright to prevent spillage.

Fire Hazard**⚠ WARNING****Combustible Gases**

Lead acid batteries present a risk of fire because they generate hydrogen gas.

Do not smoke near the batteries. Do not cause flame or spark in the battery area. Discharge static electricity from your body before touching batteries by first touching a grounded metal surface.

⚠ WARNING

Before disconnecting a battery, always remove power from the AC powered battery charger.

⚠ WARNING

When putting a battery into service on a generator set, connect the negative lead LAST; when removing the battery, disconnect the negative lead FIRST.

Vented Batteries

WARNING

Toxic Hazard

The electrolyte in vented batteries is a dilute sulfuric acid that is harmful to the skin and eyes. It is also electrically conductive and corrosive.

Always:

- 1. Wear full eye protection and protective clothing;**
- 2. If the electrolyte contacts the skin, wash it off immediately with water;**
- 3. If the electrolyte contacts the eyes, flush them thoroughly and immediately with water and seek medical attention; and**
- 4. Wash spilled electrolyte down with an acid neutralizing agent. A common practice is to use a solution of one pound (500 grams) bicarbonate of soda (also known as baking soda or sodium bicarbonate) to one gallon (4 liters) of water.**
- 5. Continue to add the bicarbonate of soda solution until the evidence of reaction (that is, foaming) has stopped.**
- 6. Flush the resulting liquid with water and dry the area.**

Battery Maintenance

WARNING

Automated Machinery

Accidental or remote starting of the generator set can cause severe personal injury or death. Arcing at battery terminals or in light switches or other equipment, and flames or sparks can ignite battery gas causing severe personal injury.

Always follow these procedures to avoid injury and/or damage:

- Ventilate the battery area before working on or near the battery.**
- Wear safety glasses.**
- Do not smoke.**
- Switch a work light on or off away from the battery.**

Make sure the generator set is shut down and disabled:

- 1. Press the generator set's red STOP button on the local display to stop the generator set. Allow the generator set to thoroughly cool to the touch.**
- 2. Turn off and disconnect the battery charger from the AC source before disconnecting the battery cables.**
- 3. Disconnect the negative (-) cable from the battery and secure it from contacting the battery terminals to prevent accidental starting.**
- 4. Once work is complete, reconnect the negative (-) battery cable last.**

Always:

- Keep the battery case and terminals clean and dry and the terminals tight.
- Remove battery cables with an insulated wrench or battery terminal puller.
- Make sure which terminal is positive (+) and which is negative (-) before making battery connections, always removing the negative (-) cable first and reconnecting it last to reduce arcing.

NOTICE

If the battery needs to be replaced, make sure that the replacement battery specifications match those found in the Model Specifications in this manual.

Battery Replacement

⚠ WARNING

Combustible Liquid

Burning the battery may cause an explosion. Damage to the casing will release electrolytes which is harmful to the skin and eyes.

When disposing of a battery, do not mutilate or burn it. Comply with all local health and safety regulations/codes during handling or disposal.

Always replace the starting battery with the same number and type (e.g., vented, lead acid, maintenance free) as listed in the specifications section of this document. Properly dispose of battery in accordance with local environment agency requirements.

Always use correct handling techniques to lift and move a battery.

5.6 Brush Block and Slip Ring Maintenance

Over time the slip rings can accumulate corrosion which needs to be cleaned off in order to have normal operation of the alternator. To clean the slip rings and brush block:

1. Press the generator set's red STOP button on the local display to disable the generator set. The generator stops immediately and both remote and standby modes are disabled.
2. Locate and remove the brush block access cover (located on the back side of the alternator near the cooling fan).
3. Use a Scotch Brite pad and clean off any build up on the slip rings. If necessary, rotate the alternator by hand while cleaning.

NOTICE

Do not use anything other than a Scotch Brite pad as this will cause damage to the slip rings and alternator.

4. Inspect the wear pattern of the brush block and measure each brush to make sure it falls within the tolerances of normal operation. Replace as necessary.
5. Tighten the brush block and make sure it has full contact with the slip rings.
6. Replace the brush block access cover and start the generator set.

5.7 Cleaning the Generator Set Housing

The housing of the generator set housing can be damaged by pressure washing or solvents and other cleaning agents. Only use soap and water or an "all citrus degreaser" to clean the housing.

5.8 Complete System Test

NOTICE

Only authorized and qualified maintenance technicians who are familiar with the equipment and its operation should carry out this test.

A complete system test is recommended to verify that the electrical system is working properly. Testing the system once every 200 hours or every 2 years is required to make sure the transfer switch will transfer the load to the generator set if there is a utility power failure. For more information, see the transfer switch owner manual.

To initiate a complete system test:

1. Before starting:
 - Check the oil level.
 - Verify that fuel related components, such as manual valves, outside of the generator set are open.
 - See the Checklist section in the installation manual.
2. Place the generator set in Standby mode.
3. Switch the main utility disconnect from the ON to the OFF position.
4. Make sure the following occurs:
 - a. The generator set starts.
 - b. After the generator set starts and stabilizes, the load is transferred from the utility to the generator set.
5. Switch the main utility disconnect from the OFF to the ON position.
6. Make sure the following occurs:
 - a. After approximately 5 minutes, the load is transferred back to the utility.
 - b. Once the transfer switch is connected to utility power, after approximately 5 minutes, the generator set stops.

NOTICE

If the test fails, call your authorized Cummins service provider to fix the problem.

6 Troubleshooting

6.1 Avoiding Generator Set Shutdowns

By regularly performing the following periodic maintenance and guidelines, you will greatly reduce the chances of a generator set shutdown:

- Maintain an appropriate oil level.
- Keep battery connections clean and tight.
- Do not overload the generator set.
- Keep the air inlet and outlet openings clear.

Refer to the Maintenance section for more information.

6.2 Troubleshooting With the Local Display

If a fault shutdown occurs the fault lamp on the local display will come on and the LCD screen will display the description of the fault, the fault number, and the hour in total generator set running time when the fault occurred.

The shutdown codes are listed below in numerical order along with step-by-step corrective actions.

6.3 Troubleshooting by Symptom

Starting Battery Runs Down

Possible Cause: Marginal battery connections, battery, charging system, excessive cranking

Corrective Actions:

1. Clean and tighten positive (+) and negative (-) battery cable connections at the battery.
2. Recharge or replace battery. Refer to the battery manufacturer's recommendations.
3. Have battery charger serviced by an authorized Cummins dealer.

Starter Engages - Disengages

Possible Causes: Cranking voltage dips below 8 VDC, battery connections, battery, charging system, start/stop switches

Corrective Actions:

1. Clean and tighten positive (+) and negative (-) battery cable connections at the battery.

2. Recharge or replace battery. Refer to the battery manufacturer's recommendations.
3. Have the battery charger serviced by an authorized Cummins dealer.

No AC Power - Generator Set Running

Logic: Circuit breakers have tripped due to overload or short.

Possible Causes:

1. Circuit breakers
2. Customer loads

Diagnosis and Repair:

1. Circuit breakers
 - a. Reset or turn on the generator set circuit breaker.
 - b. Reset or turn on the circuit breaker in the distribution panel.
 - c. Have an authorized electrician verify the circuits from the generator set and distribution panel.
2. Customer loads
 - Reduce number of loads.

Generator Set Cranks But Does Not Start - No Fault Code

Possible Causes: Inadequate air, fuel or spark

Diagnosis and Repair:

1. Check that the air filter is free of obstructions. Replace it if it is blocked.
2. Make sure the manual fuel shutoff valve is open.
3. If the previous steps do not resolve the problem, contact your Cummins service representative.

6.4 Troubleshooting with Fault Codes

Fault Code Introduction

Fault code information, together with warning and shutdown information, is provided in this section to assist in locating and identifying the possible causes of faults in the generator set system.

Refer also to the engine-specific operator manual, if it exists. The engine operator manual contains additional information regarding the running and care of the generator set as well as specific equipment instructions that may differ from the standard generator set.

For any fault codes that occur but are not listed, contact your Cummins service representative.

Code 2 - Low Oil Pressure Fault

Possible Causes:

- Faulty oil pressure relief valve
- Faulty oil pump
- Faulty switch
- Oil level too low/high

Diagnosis and Repair:

1. Check the oil level.
2. Add or drain oil as necessary.
3. If the previous steps do not resolve the problem, contact your Cummins service representative for assistance.

Code 4 - Overcrank

Possible Causes:

- Air fuel mixture
- Exhaust system
- Faulty external start command
- Fuel supply
- Ignition system
- Starter
- Wire connections

Diagnosis and Repair:

1. Open any closed fuel valves.
2. Ensure spark plug wires are secured to the spark plugs.
3. Check and service the air filter as necessary.
4. Contact your Cummins service representative for assistance.

 **WARNING**

Some generator set service procedures present hazards that can result in severe personal injury or death. Only trained and experienced service personnel with knowledge of fuels, electricity, and machinery hazards should perform generator set service.

Code 12 - Overvoltage

Possible Causes:

- Generator set loads
- Windings

- Wire connections

Corrective Action:

1. Have the unit serviced by an authorized Cummins dealer.

Code 13 - Undervoltage**Possible Causes:**

- Generator set loads
- Wire connections
- Windings

Corrective Action:

1. Have the unit serviced by an authorized Cummins dealer.

Code 14 - Overfrequency**Possible Causes:**

- Air fuel mixture
- Alternator windings
- Carburetor
- Demand regulator
- Engine governor function
- Exhaust system
- Fuel supply
- Generator set loads
- Wire connections

Diagnosis and Repair:

1. Have the unit serviced by an authorized Cummins dealer.

Code 15 - Underfrequency**Possible Causes:**

- Air fuel mixture
- Carburetor
- Demand regulator
- Engine governor function
- Exhaust system
- Fuel supply
- Generator set loads
- Generator windings

- Ignition
- Wire connections

Diagnosis and Repair:

1. Reduce the number of connected loads especially loads that require higher starting current, such as air conditioners.
2. Have the unit serviced by an authorized Cummins dealer.

Code 19 - Governor Actuator Shutdown**Possible Causes:**

- Governor actuator
- Wire connections

Corrective Action:

1. Have the unit serviced by an authorized Cummins dealer.

Code 22 - Governor Actuator Overload**Possible Causes:**

- Air fuel mixture
- Fuel supply
- Exhaust system
- Generator set loads
- Governor actuator
- Ignition system
- Wire connections

Corrective Actions:

1. Reduce the number of connected loads especially loads that require higher starting current such as air conditioners.
2. Check and service air filter as necessary.
3. Have the unit serviced by an authorized Cummins dealer.

Code 27 - Voltage Sense Lost**Possible Causes:**

- Alternator windings
- Generator set loads
- Ignition
- Wire connections

Corrective Action:

1. Have the unit serviced by an authorized Cummins dealer.
-

⚠ WARNING

Some generator set service procedures present hazards that can result in severe personal injury or death. Only trained and experienced service personnel with knowledge of fuels, electricity, and machinery hazards should perform generator set service.

Code 29 - High Battery Voltage

Possible Causes:

- Control
- Faulty charger
- Incorrect battery configuration
- Wire damage

Corrective Action:

1. Have the battery charger serviced by an authorized Cummins dealer.

Code 32 - Low Cranking Speed Sense

Possible Causes:

- Air intake system
- Alternator windings
- Battery
- Battery connections
- Brushes and slip rings
- Engine components
- Exhaust system
- Oil viscosity
- Starter
- Wire connections

Corrective Actions:

1. Clean and tighten the positive (+) and negative (–) battery cable connections at the battery.
2. Recharge or replace the battery. Refer to the battery manufacturer's recommendations.
3. Verify that brushes and slip rings are in good condition. If not, clean slip rings and/or replace brushes.
4. Verify that the engine oil viscosity is correct for the ambient temperature. If not, refill and replace engine oil with the correct viscosity.
5. Have the unit serviced by an authorized Cummins dealer.

Code 35 - Control Card Failure

Possible Cause: Faulty program

Corrective Action:

1. Have the unit serviced by an authorized Cummins dealer.

Code 36 - Generator Set Stopped without Fault Condition

Possible Causes:

- Air fuel mixture
- Alternator windings
- Carburetor
- Demand regulator
- Exhaust system
- Fuel supply
- Ignition
- Wire connections

Diagnosis and Repair:

1. Check the fuel source.
2. Open any closed fuel valves.
3. Secure spark plug leads to spark plugs.
4. Check and service air filter as necessary.
5. Check for mechanical damage.
6. Have the unit serviced by an authorized Cummins dealer.

Code 37 - Invalid Set Configuration

Possible Causes:

- Control
- Generator set configuration

Diagnosis & Repair:

1. Have the unit serviced by an authorized Cummins dealer.

Code 43 - Processor Fault

Possible Cause: Faulty program

Corrective Action:

1. Have the unit serviced by an authorized Cummins dealer.

Code 45 - Speed Sense Fault

Possible Causes:

- Alternator windings
- Loads
- Wire connections

Corrective Action:

1. Have the unit serviced by an authorized Cummins dealer.

Code 46 - Generator Set Overload

Possible Causes:

- Loads
- Windings
- Wire connections

Corrective Actions:

1. Reduce the number of connected loads especially loads that require higher starting current such as air conditioners.
2. Check and service air filter as necessary.
3. Have the unit serviced by an authorized Cummins dealer.

Code 76 - Alternator Over Temp

Possible Causes:

- Blocked intake or exhaust openings
- Faulty fan
- Faulty temperature sensor
- Wire connections

Diagnosis and Repair:

1. Verify the generator set enclosure for clear intake and exhaust openings.
2. Have the unit serviced by an authorized Cummins dealer.

6.5 Remote Monitoring Communication Troubleshooting

Webpage or Mobile App Does Not Respond

Possible Causes:

1. Connection problems exist between the mobile device or computer and the Connect Cloud.

2. The web page or app has encountered an error.
3. The mobile device or computer has experienced an error.
4. The Connect Cloud is unavailable.

Diagnosis and Repair:

1. Connection problems exist between the mobile device or computer and the Connect Cloud.
 - a. Refer to the Mobile Device or Computer Connection Problem section.
2. The web page or app has encountered an error.
 - a. Close the web browser and access the Connect Cloud from a new browser window.
 - b. Close and end the mobile app session. Then restart the application.
3. The mobile device or computer has experienced an error.
 - a. Completely restart the mobile device or computer.
4. The Connect Cloud is unavailable.
 - a. Verify availability by accessing the Connect Cloud from another device and/or another browser.

Generator Set Connection Problems**Possible Causes:**

1. The generator set is not connected to the Internet.
2. There are router and/or firewall problems.
3. The Connect Cloud is unavailable.
4. The control board software is not current.
5. There is a generator set control board problem.

Diagnosis and Repair:

1. The generator set is not connected to the Internet.
 - a. Verify the Internet connection status on the generator set local or remote display. This information is displayed on the Cloud Info screen in the MENU – About.
 - If the control is failing to connect to the Internet after multiple tries, power-cycle the control.
 - b. Check the generator set control board for the IP address and data transfer “heartbeat”.
 - i. Use the generator set’s local display or remote display to navigate through the menus until you find the IP address. Make sure that there is a valid IP address shown.

-
- ii. Check the generator set control board for illuminated green and orange lights (also known as the “heartbeat”) near the Ethernet port. If the board is properly communicating with the network, the lights should flicker on and off irregularly.
 - c. Battery voltage is low.
 - Refer to the Starting Battery Runs Down or Low Battery Warning Is Active section.
 - d. The customer’s modem or router has no Internet connectivity.
 - i. Check the Internet connection indicator on the modem or router.
 - If the Internet connection indicator is not illuminated, reset the modem or router. Refer to the modem or router owner’s manual for the proper procedure.
 - ii. Access a web page using a computer connected via Ethernet cable to the same modem or router that the generator set is connected to.
 - iii. Contact the Internet Service Provider (ISP) for additional troubleshooting.
 - e. Check the Ethernet cable to the generator set.
 - i. Verify that the Ethernet cable type is Cat 5, Cat 5e, or Cat 6.
 - ii. Verify that the Ethernet cable is fully seated in the generator set control.
 - iii. Verify that the cable is fully seated in the router or modem.
 - iv. Check the cable for breaks or damage; replace if necessary.
 - v. If a laptop is available for testing, unplug the Ethernet cable at the generator set and connect the laptop. Verify that the laptop has Internet access over the local network.
 2. There are router and/or firewall problems.
 - Reset the firewall settings on the modem or router. The remote monitoring system requires open communication to 168.61.54.255 on port 8884 and 40.114.00.153 on port 8885. Refer to the modem or router owner’s manual for the proper procedure.
 - It is also possible the Internet service provider is blocking communication to these addresses or these ports outside of the customers network. Contact the Internet service provider for additional troubleshooting if the generator set is still not able to connect after the customers internet and firewall settings have been verified.
 3. The Connect Cloud is unavailable.
 - Verify availability by accessing the Connect Cloud from another device, and/or another browser.
-

4. The control board software is not current.
 - Ensure the control board software matches the latest version available. See the Control Software Updates section for information on how to perform control software updates.
5. There is a generator set control board problem.
 - If there is still a problem after you have completed all other troubleshooting, it is possible the control board has a problem and must be replaced. However, it is very unlikely that the remote monitoring portion of the control board has a problem if all other generator set functions are operational.

Mobile Device or Computer Connection Problem

Possible Causes:

1. The Connect Cloud web page does not load because of an Internet connection problem.
2. The mobile device or computer has an Internet connection problem.
3. The customer's modem or router does not have Internet connectivity.

Diagnosis and Repair:

1. The Connect Cloud Web page does not load because of an Internet connection problem.
 - a. Open your preferred browser and navigate to another web page to verify the Internet connection.
 - b. Reset the Internet settings or access the Connect Cloud from another browser.
2. The mobile device or computer has an Internet connection problem.
 - a. Make sure that at least one of the following conditions is true:
 - The mobile device or computer is connected via an Ethernet cable.
 - The mobile device or computer Wi-Fi is enabled and connected.
 - The mobile device or computer cellular data signal strength is acceptable.
 - b. If you are unable to resolve an Internet connection problem, contact the cellular data or Internet Service Provider.
3. The customer's modem or router does not have Internet connectivity.
 - a. Check the Internet connection indicator on the modem or router.
 - If the Internet connection indicator is not illuminated, reset the modem or router. Refer to the modem or router owner's manual for the proper procedure.
 - b. Access a web page using a computer connected via Ethernet cable to the same modem or router that the generator set is connected to.
 - c. Contact the Internet Service Provider (ISP) for additional troubleshooting.

No Email Notifications Are Being Received

Possible Causes:

1. The incorrect email address was entered.
2. Emails are being filtered by a spam filter.
3. Connection problems exist between the generator set and the Connect Cloud.
4. The Connect Cloud is unavailable.
5. There is a generator set control board failure.

Diagnosis and Repair

1. The incorrect email address was entered.
 - Verify the email address by using Preferences, Manage Users on the Connect Cloud.
2. Emails are being filtered by a spam filter.
 - a. Check your spam and junk folder for messages.
 - b. If you find emails from “noreply@powercommandcloud.com” in your junk/spam folder, add this address to your list of trusted senders, or select this sender as safe.
3. Connection problems exist between the generator set and the Connect Cloud.
 - Refer to the Generator Set Connection Problem section.
4. The Connect Cloud is unavailable.
 - Verify availability by accessing the Connect Cloud from another device and/or another browser.
5. There is a generator set control board problem.
 - If there is still a problem after you have completed all other troubleshooting, it is possible the control board has a problem and must be replaced. However, it is very unlikely that the remote monitoring portion of the control board has a problem if all other generator set functions are operational.

Web Page Information Not Updating or Is Updating Slowly

Possible Causes:

1. Data has not been refreshed.
2. Connection problems exist between the mobile device or computer and the Internet.
3. The user is not logged in.
4. The Internet connection is slow.
5. Connection problems exist between the generator set and the Connect Cloud.
6. The Connect Cloud is unavailable.

Diagnosis and Repair:

1. Data has not been refreshed.
 - Refresh the web page or the mobile app by using the refresh function in the menu or by swiping down.
2. Connection problems exist between the mobile device or computer and the Internet.
 - Refer to the Mobile Device or Computer Connection Problem section.
3. The user is not logged in.
 - Make sure that you are logged in using the correct username and password.
4. The Internet connection is slow.
 - Verify that the Internet bandwidth of the network that the generator set is connected to has at least 1 mbps download speed. Use an Internet speed testing website on the same modem/router as the generator set to confirm connection speed.
5. Connection problems exist between the generator set and the Connect Cloud.
 - Refer to the Generator Set Connection Problems section.
6. The Connect Cloud is unavailable.
 - Verify availability by accessing the Connect Cloud from another device, and/or another browser.

Generator Set Does Not Respond to Start and/or Stop Commands from the Web Page or Mobile App**Possible Causes:**

1. Remote Enable is not enabled at the local display.
2. Connection problems exist between the generator set and the Connect Cloud.
3. Connection problems exist between the mobile device or computer and the Connect Cloud.
4. The generator set is receiving a remote start command, but another failure has occurred preventing the generator set from starting.
5. The generator set is receiving a remote stop command, but another failure has occurred preventing the generator set from stopping.
6. The Connect Cloud is unavailable.

Diagnosis and Repair:

1. Remote Enable is not enabled at the local display.
 - Change the Remote Enable setting to Enabled on the local display.
2. Connection problems exist between the generator set and the Connect Cloud.
 - Refer to the Generator Set Connection Problems section.

3. Connection problems exist between the mobile device or computer and the Connect Cloud.
 - Refer to the Mobile Device or Computer Connection Problem section.
4. The generator set is receiving a remote start command, but another failure has occurred preventing the generator from starting.
 - a. Check the local or remote display, the mobile app, or the website for faults on the generator set.
 - b. Attempt to start the generator set from the local display.
5. The generator set is receiving a remote stop command, but another failure has occurred preventing the generator set from stopping.
 - a. Stop the generator set using the local display.
 - b. Stop the generator set using the local emergency stop.
6. The Connect Cloud is unavailable.
 - Verify availability by accessing the Connect Cloud from another device and/or another browser.

Mobile App Push Notifications Do Not Appear

Possible Causes:

1. Push notifications are not enabled in the Connect Cloud app.
2. Mobile device application permissions do not allow push notifications.

Diagnosis and Repair:

1. Push notifications are not enabled in the Connect Cloud app.
 - Enable push notifications in the Connect Cloud app settings.
2. Mobile device application permissions do not allow push notifications.
 - Change the mobile device settings on your phone or other mobile device to allow push notifications from the application.

User Unable to Log In

Possible Causes:

1. The Username or password is incorrect.
2. The Connect Cloud is unavailable.

Diagnosis and Repair:

1. The Username or password is incorrect.
 - a. Make sure that you are using the correct username and password.
 - b. Make sure that the caps lock is not active.
 - c. Click on the “Can’t access your account?” link to recover the account.

2. The Connect Cloud is unavailable.

- Verify availability by accessing the Connect Cloud from another device and/or another browser.

Generator Set Starts or Stops Unexpectedly

Possible Causes:

1. An accidental web page or mobile app start/stop command was received.

Diagnosis and Repair:

1. An accidental web page or mobile app start/stop command was received.
 - a. The mobile app has the option to enable a PIN for any start/stop commands. Enable or disable the PIN in the mobile app settings.
 - b. The Connect Cloud website requires a confirmation for any start/stop commands.

This page is intentionally blank.

power.cummins.com

Copyright © 2019 Cummins Inc. All rights reserved.

Cummins, the "C" logo, PowerCommand, AmpSentry, and InPower are trademarks of Cummins Inc.

Other company, product, or service names may be trademarks or service marks of others.

Specifications are subject to change without notice.

