



**ULTRA QUIET & OIL FREE  
AIR COMPRESSOR  
OWNER'S MANUAL**

**CALIFORNIA AIR TOOLS  
60065C**

**6.5 HP    3-Phase 230v 60hz**

**20.0 CFM @ 40 PSI, 17.0 CFM @ 90 PSI**

**60 GALLON ASME STEEL TANK**



## TABLE OF CONTENTS

INTRODUCTION	2
IMPORTANT SAFETY INSTRUCTIONS	3
LOCATIONS OF IMPORTANT LABELS	6
AIR COMPRESSOR COMPONENTS	7
PRE-OPERATION CHECKLIST	8
Package Contents & Assembly	8
Inspect for Damage	9
Save Packaging	9
Compressor Location	9
Electrical Power	10
OPERATING THE AIR COMPRESSOR	10
Introduction	10
Assembly	10
Test Run	11
Daily Operation	11
MAINTENANCE	12
Draining the Air Tank	12
Changing the Air Filter	12
Testing for Leaks	12
Pressure Switch	12
Cleaning	12
STORAGE	12
TROUBLESHOOTING	13
SPECIFICATIONS	14
Electrical Circuit	14
Air Passage Drawing	14
WARRANTY	15
PRODUCT REGISTRATION	17

## INTRODUCTION

### **WARNING**

This manual contains important instructions for operating this product. For your safety, and the safety of others, be sure to read this manual thoroughly before operating the product.

Failure to properly follow all the instructions and precautions can cause you and others to be seriously hurt or killed.

Thank you for purchasing a California Air Tools, Inc. Air Compressor.

Please contact us if you have any questions.

Record the model and serial numbers indicated on your air compressor's nameplate:

Model No. \_\_\_\_\_

Serial No. \_\_\_\_\_

Date of Purchase: \_\_\_\_\_

Store/Dealer: \_\_\_\_\_

## How to find a local service center:

Even quality built equipment might need service or repair parts. Contact the California Air Tools Customer Service Department:

Phone: 1-866-409-4581

Online: WWW.CALIFORNIAAIRTOOLS.COM

## Please provide the information below:

Model number and Serial number and specifications shown on the Model number/Serial number plate.

Part number or numbers shown in the parts list section of the owner's manual for your air compressor model.

A brief description of the trouble with the air compressor.

**Do not return your air compressor for service or parts to the store/dealer where purchased.**

## IMPORTANT SAFETY INSTRUCTIONS

### Safety Messages & Signal Words:

#### **⚠ DANGER**

Indicates an immediate hazardous situation which, if not avoided, will result in death or serious injury to the operator or to bystanders.

#### **⚠ WARNING**

Indicates a potentially hazardous situation which, if not avoided, could result in death or serious injury to the operator or to bystanders.

#### **⚠ CAUTION**

Indicates a potentially hazardous situation which, if not avoided, may result in moderate or minor injury to the operator or to bystanders.

#### **NOTICE**

Indicates a situation which, if not avoided, may result in damage to product components or other property.

#### **⚠ DANGER**



#### **RISK OF CUTTING**

**Moving parts can cause severe trauma.**

**Keep hands and feet away from rotating parts, tie up long hair, remove jewelry, and DO NOT wear loose clothing.**

#### **⚠ DANGER**



#### **SHOCK**

There is a danger of electric shock.

Use only undamaged electrical cords.

**DO NOT** touch bare wires or receptacles.

**DO NOT** operate air compressor in wet weather or in wet conditions.

**DO NOT** touch air compressor or cords if hands or feet are wet.

Ensure that all cords are free of damage before connecting to the power supply.

Ensure that you have a sufficient electrical supply for supporting the requirements of the motor.

Improper installation of the grounding plug is able to result in a risk of electric shock. When repair or replacement of the cord or plug is required, do not connect the grounding wire to either flat terminal. The wire with insulation having an outer surface that is green with or without yellow stripes is the grounding wire.

This product must be grounded. In the event of an electrical short circuit, grounding reduces the risk of electrical shock by providing an escape wire for the electric current.

This product is equipped with a cord having a grounding wire with an appropriate grounding plug. The plug must be plugged into an outlet that is properly installed and grounded in accordance with the local codes and ordinances.

## ⚠️ WARNING



### RISK TO BREATHING

Dust or dust-like particulates caused by power-sanding, sawing, grinding, drilling or any other construction-like activities can contain contaminants that are harmful to breathe.

Always use your air compressor in a well-ventilated and clean area.

Never breathe the air that comes directly out of the air compressor or air hose. This air is not suitable for breathing.

Always wear approved safety equipment. When performing dust-creating activities, securely wear properly-fit face masks or respirators.

If you feel ill from breathing while operating your air compressor, stop and seek medical attention immediately.

## ⚠️ WARNING



### FLYING OBJECTS

Flying object can cause injury to the eyes, head and other parts of the body.

Air-powered equipment and power tools are capable of propelling items (metal chips, fasteners and particulates) at high speed into the air and could result in injury.

Always wear approved head and eye protection.

Never point the air stream at any part of the body, or at another person or animal.

When operating the air compressor, make sure all other people and animals maintain a safe distance.

Do not move the air compressor when the air tank is under pressure.

Never use the air hoses to pull or move the air compressor.

Keep the air compressor on a flat surface.

## ⚠️ WARNING



### HOT SURFACE



### FIRE

Air compressor surfaces become hot during operation.

**DO NOT** touch hot surfaces, because they can cause severe burns.

Do not touch the air compressor's cylinder head. During operation, the cooling fins of the cylinder head and delivery pipe become hot.

Allow the air compressor to cool before touching it.

**DO NOT** place a storage cover on the unit during operation. Only place a cover on the air compressor after it has thoroughly cooled down.

## ⚠️ WARNING



### EXPLOSION

Exercise caution when using pressurized air.

To prevent injury and for your general safety, only use high-pressure hoses, fittings and couplings designed for use with air compressors.

Inspect all hoses, fittings and couplings for leaks and wear. When leaks and wear detected, stop use and replace those items immediately. Do not repair.

Never leave pressurized air in the air tank when performing maintenance.

Never leave air compressor unattended with the power supply in use and the air hose connected.

## ⚠️ WARNING



EXPLOSION

Improper care could lead to the air tank bursting or exploding.

Drain air tank daily or after each use to prevent moisture buildup in the air tank.

Rust can weaken the air tank and cause leaks or bursting. If rust is detected, replace tank immediately. Do not try to repair the air tank by welding, drilling or modifying it in any other way. These modifications can weaken the air tank and cause a hazardous condition.

If air tank develops a leak, replace the air tank immediately. Never repair, weld or make modifications to the air tank or its attachments.

Never make adjustments to the factory-set pressures.

Never exceed manufacturer's maximum-allowable pressure rating attachments.

Because of extreme heat, do not use plastic pipe or lead tin solder joints for a discharge line.

## ⚠️ WARNING



EXPLOSION



FIRE

Use caution to minimize risk of fire or explosion.

It is normal for the air compressor motor and pressure switch to produce sparks while operating. If sparks come in contact with vapors from gasoline or solvents, they may ignite and cause a fire or explosion.

Abrasive tools such as grinders, drills and other tools are capable of making sparks that can ignite flammable materials.

Always operate the air compressor a safe distance away from flammable items. Use in well-ventilated areas.

Never exceed the maximum rated pressure.

## ⚠️ CAUTION

Use caution when using extension cords.

If using an extension cord, use a heavy duty locking power cord, 4-prong, 20 AMP (L15-20P to L15-20R). 50 foot maximum is suggested.



As undersized cord results in a drop in the line voltage and loss of power and overheating.

When in doubt, use a heavier gauge. The smaller the gauge the more current the cord can carry.

## ⚠️ CAUTION

**THIS EQUIPMENT INCORPORATES PARTS, SUCH AS SNAP SWITCHES, RECEPTACLES AND THE LIKE THAT TEND TO PRODUCE ARCS OR SPARKS, THERE, WHEN LOCATED IN A GARAGE, IT SHOULD BE IN A ROOM OR ENCLOSURE PROVIDED FOR THE PURPOSE, OR SHOULD BE 18 IN (45.7 CM) OR MORE ABOVE THE FLOOR.**

### L15-20R Electrical Receptacle (3-phase, 20 ampere, 220 volts)

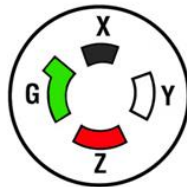
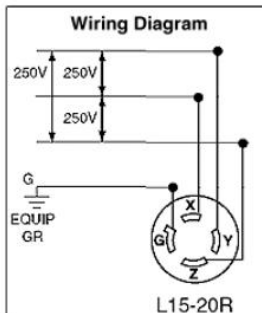

L15-20P Plug

## LOCATIONS OF IMPORTANT LABELS

Read these important labels before operating.

These labels provide important safety and maintenance information. These labels should be considered as permanent parts of the air compressor. Should any of these labels become illegible, damaged or removed, please contact California Air Tools Customer Service department at 1-866-409-4581 for replacements.

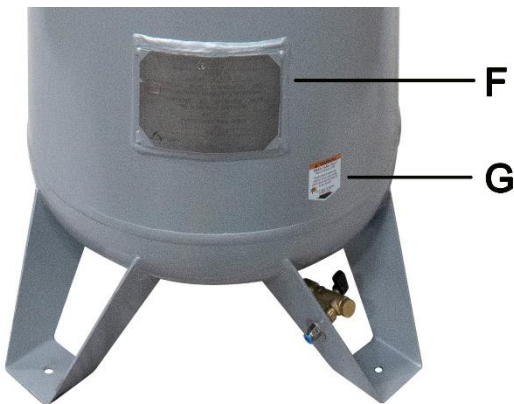
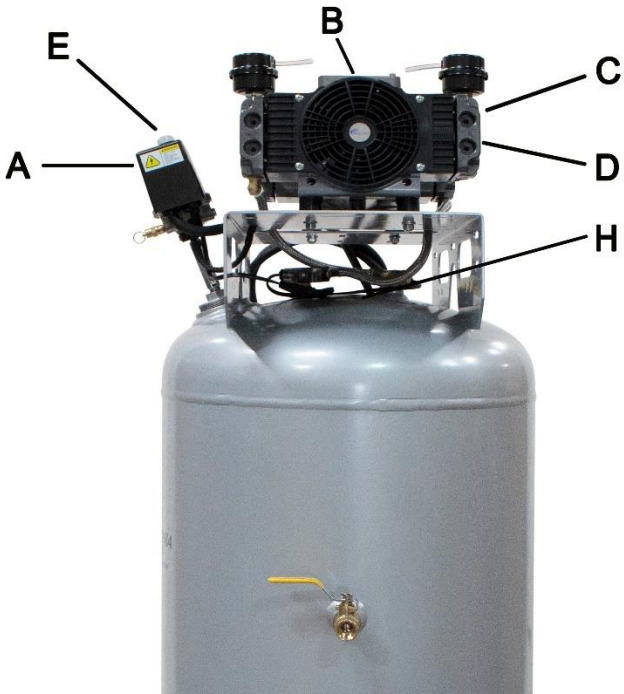

PRODUCT LABEL																													
A																													
B																													
C																													
D																													
E																													
F		ASME Certification																											
G																													
H	<table border="1"> <thead> <tr> <th>⚠ WARNING</th> <th>⚠ ADVERTENCIA</th> <th>⚠ AVERTISSEMENT</th> </tr> </thead> <tbody> <tr> <td>READ MANUAL TO LOCATE THE PLACE OF ALL LABELS. USER MUST READ AND UNDERSTAND ALL INFORMATION PROVIDED ON ALL LABELS BEFORE ANY OPERATION.</td> <td>LEER EL MANUAL PARA LOCALIZAR EL LUGAR DE TODOS LOS ETIQUETAS. EL USUARIO DEBE LEER Y ENTENDER EL MANUAL DEL OPERADOR ANTES DE CUALQUIER OPERACION DEL COMPRESOR DE AIRE.</td> <td>LIRE LE MANUEL POUR LOCALISER LE LIEU DE TOUTES LES ETIQUETTES. L'UTILISATEUR DOIT LIRE ET COMPRENDRE LE MANUEL DE L'UTILISATEUR AVANT D'UTILISER LE COMPRESOR D'AIR.</td> </tr> <tr> <td>WEAR EYE PROTECTION WHEN YOU WORK WITH AIR TOOLS.</td> <td>USAR PROTECCION PARA LOS OJOS QUE CUMPLAN CON EL ESTANDAR ANSI Z87.1.</td> <td>PORTER DES LUNETTES DE PROTECTION COMPORTANT LA MENTION DE CONFORMITE A LA NORME ANSI Z87.1.</td> </tr> <tr> <td>NO FLY OF AIR. DO NOT DIRECT AIR STREAM AT BODY. DO NOT USE COMPRESSED AIR FOR BREATHING.</td> <td>RIESGO DE LESIONES. NO DIRIGIR CORRIENTES DE AIRE HACIA EL CUERPO. NO UTILIZAR AIRE COMPRESOR PARA RESPIRAR.</td> <td>RIQUE DE BLESSURE. NE PAS DIRIGER LE FLUX D'AIR VERS LE CORPS. NE PAS RESPIRER L'AIR COMPRIME.</td> </tr> <tr> <td>NO FLY OF FIRE OR EXPLOSION. DO NOT TOUCH CHANGIBLE COILS IN A COMPRESSOR AREA. STOP WORK IMMEDIATELY IF YOU NOTICE DO NOT TOUCH WHILE SPRAYING OR PAINTING WORKS. DO NOT REMOVE OR DISCONNECT AIR HOSES FROM AIR TOOLS. ALWAYS WEAR USE AN APPROVATELY RATED STOP VALVE TO STOP THE AIR FLOW AND KEEP THE COMPRESSOR ON OFF OR LOCK OUT TAG OUT WHEN YOU STOP WORK.</td> <td>RIESGO DE INCENDIO O EXPLOSION. NO TOQUE LAS bobinas intercambiables en un área cercana a la zona de la salida de flujo de aire. DETENER EL TRABAJO INMEDIATAMENTE SI SE OBSERVAN VERTIDOS O FUMOS. NO TOQUE MIENTRAS SE TRABAJA CON SPRAY O PINTURA. NO QUITAR NI DESCONECTAR LAS MANGUERAS DE LOS HERRAMIENTAS DE AIRE. SIEMPRE USAR UN VALVULA DE CIERRE APROPIADA PARA DETENER EL FLUJO DE AIRE Y MANTENER EL COMPRESOR EN LA POSICION DE APAGADO O BLOQUEADO Y ETIQUETADO CUANDO SE DETIENE EL TRABAJO.</td> <td>RIQUE D'INCENDIE OU D'EXPLOSION. NE PAS TOUCHER DES bobines interchangeables dans la zone de flux d'air. ARRÊTER LE TRAVAIL EN CAS DE FUMÉE OU D'ÉMISSION DE BRÛLURE. NE PAS TOUCHER PENDANT LE TRAVAIL À L'AÉROSOIF OU À LA PEINTURE. NE PAS ENLEVER NI DÉCONNECTER LES TUYAUX D'AIR DES Outils À AIR. TOUJOURS UTILISER UN VANNEAU APPROPRIÉ POUR ARRÊTER LE FLUX D'AIR ET GARDER LE COMPRESSEUR EN POSITION D'ARRÊT OU DE VERROUILLAGE ET ÉTIQUETAGE QUAND ON ARRÊTE LE TRAVAIL.</td> </tr> <tr> <td>NO FLY OF BURNING. DO NOT ADJUST REGULATORS TO RESULT IN THE OUTPUT PRESSURE GREATER THAN MARKED NOMINAL PRESSURE OF ATTACHMENT TO TOOL OR TANK.</td> <td>RIESGO DE QUEMOS. NO AJUSTAR EL REGULADOR PARA OBTENER UNA PRESION DE SALIDA SUPERIOR A LA MARCADA NOMINAL MARCADA POR EL FABRICANTE. NO AJUSTAR EN UN LUGAR RESERVADO.</td> <td>RIQUE D'ÉCHAUFFEMENT. NE PAS AJUSTER LE RÉGULATEUR POUR OBTENIR UNE PRESION DE SORTIE SUPÉRIEURE À LA MARQUE NOMINALE MARQUÉE SUR L'ACCESSOIRE. NE PAS AJUSTER EN UN LIEU RÉSERVÉ.</td> </tr> <tr> <td>TO REMOVE THE AIR FROM AN ELECTRIC TOOL, DO NOT EXPOSE TO WATER. STOP WORK.</td> <td>PARA QUITAR EL AIRE DE UNA HERRAMIENTA ELÉCTRICA, NO EXPOSER AL AGUA. DETENER EL TRABAJO.</td> <td>POUR RÉGULER L'AIR D'UN Outils ÉLECTRIQUE, NE PAS L'EXPOSER À L'EAU. ARRÊTER LE TRAVAIL.</td> </tr> <tr> <td>NO ELECTRICAL SHOCK. ALWAYS DISCONNECT FROM POWER SOURCE BEFORE SERVICE. COMPRESSOR MUST BE DEENERGIZED.</td> <td>RIESGO DE CHOQUE ELÉCTRICO. SIEMPRE DESCONECTAR DEL FUENTE DE ENERGIA ANTES DE SERVICIO. EL COMPRESOR DEBE CONECTAR A TIERRA.</td> <td>RIQUE D'ÉLECTROCUTION. TOUJOURS DÉCONNECTER L'APPAREIL DE L'ALIMENTATION ÉLECTRIQUE AVANT TOUT TRAVAIL. LE COMPRESSEUR DOIT ÊTRE MIS À LA TERRE.</td> </tr> <tr> <td>THIS EQUIPMENT INCORPORATES PARTS, SUCH AS SWAP PARTS, REPAIRS AND THE LIKE THAT ARE NOT COVERED BY OUR WARRANTY. THESE PARTS ARE LOCATED IN A GARAGE. IT SHOULD BE IN A ROOM OR FACILITY PROVIDED FOR THE PURPOSE. WE DO NOT HAVE A RIGHT TO WORK ABOVE THE FLOOR.</td> <td>ESTE EQUIPO INCLUYE PARTES COMO REPUESTAS, REPARACIONES Y SIMILARES QUE NO ESTÁN CUBIERTAS POR NUESTRO PROGRAMA DE GARANTIA. ESTAS PARTES SE ENCUENTRAN EN UNA SALA O HERRERIA DEDICADA PARA SU USO. NO TENEMOS DERECHO A TRABAJAR ENCIMA DEL PISO.</td> <td>CECI EQUIPEMENT COMPREND DES PARTES, TELS QUE DES INTERCHANGIBLES ET COPIES REPARATION. CES COMPOSANTS ET CES REPARATIONS NE SONT PAS COUVERTES PAR NOTRE PROGRAMME DE GARANTIE. CES PARTES SONT LOCALISÉES DANS UNE SALLE OU UN BÂTIMENT DESTINÉ À CETTE FIN OU À UN BÂTIMENT ANNEXE AU DÉPÔT DE LA SALLE.</td> </tr> </tbody> </table>	⚠ WARNING	⚠ ADVERTENCIA	⚠ AVERTISSEMENT	READ MANUAL TO LOCATE THE PLACE OF ALL LABELS. USER MUST READ AND UNDERSTAND ALL INFORMATION PROVIDED ON ALL LABELS BEFORE ANY OPERATION.	LEER EL MANUAL PARA LOCALIZAR EL LUGAR DE TODOS LOS ETIQUETAS. EL USUARIO DEBE LEER Y ENTENDER EL MANUAL DEL OPERADOR ANTES DE CUALQUIER OPERACION DEL COMPRESOR DE AIRE.	LIRE LE MANUEL POUR LOCALISER LE LIEU DE TOUTES LES ETIQUETTES. L'UTILISATEUR DOIT LIRE ET COMPRENDRE LE MANUEL DE L'UTILISATEUR AVANT D'UTILISER LE COMPRESOR D'AIR.	WEAR EYE PROTECTION WHEN YOU WORK WITH AIR TOOLS.	USAR PROTECCION PARA LOS OJOS QUE CUMPLAN CON EL ESTANDAR ANSI Z87.1.	PORTER DES LUNETTES DE PROTECTION COMPORTANT LA MENTION DE CONFORMITE A LA NORME ANSI Z87.1.	NO FLY OF AIR. DO NOT DIRECT AIR STREAM AT BODY. DO NOT USE COMPRESSED AIR FOR BREATHING.	RIESGO DE LESIONES. NO DIRIGIR CORRIENTES DE AIRE HACIA EL CUERPO. NO UTILIZAR AIRE COMPRESOR PARA RESPIRAR.	RIQUE DE BLESSURE. NE PAS DIRIGER LE FLUX D'AIR VERS LE CORPS. NE PAS RESPIRER L'AIR COMPRIME.	NO FLY OF FIRE OR EXPLOSION. DO NOT TOUCH CHANGIBLE COILS IN A COMPRESSOR AREA. STOP WORK IMMEDIATELY IF YOU NOTICE DO NOT TOUCH WHILE SPRAYING OR PAINTING WORKS. DO NOT REMOVE OR DISCONNECT AIR HOSES FROM AIR TOOLS. ALWAYS WEAR USE AN APPROVATELY RATED STOP VALVE TO STOP THE AIR FLOW AND KEEP THE COMPRESSOR ON OFF OR LOCK OUT TAG OUT WHEN YOU STOP WORK.	RIESGO DE INCENDIO O EXPLOSION. NO TOQUE LAS bobinas intercambiables en un área cercana a la zona de la salida de flujo de aire. DETENER EL TRABAJO INMEDIATAMENTE SI SE OBSERVAN VERTIDOS O FUMOS. NO TOQUE MIENTRAS SE TRABAJA CON SPRAY O PINTURA. NO QUITAR NI DESCONECTAR LAS MANGUERAS DE LOS HERRAMIENTAS DE AIRE. SIEMPRE USAR UN VALVULA DE CIERRE APROPIADA PARA DETENER EL FLUJO DE AIRE Y MANTENER EL COMPRESOR EN LA POSICION DE APAGADO O BLOQUEADO Y ETIQUETADO CUANDO SE DETIENE EL TRABAJO.	RIQUE D'INCENDIE OU D'EXPLOSION. NE PAS TOUCHER DES bobines interchangeables dans la zone de flux d'air. ARRÊTER LE TRAVAIL EN CAS DE FUMÉE OU D'ÉMISSION DE BRÛLURE. NE PAS TOUCHER PENDANT LE TRAVAIL À L'AÉROSOIF OU À LA PEINTURE. NE PAS ENLEVER NI DÉCONNECTER LES TUYAUX D'AIR DES Outils À AIR. TOUJOURS UTILISER UN VANNEAU APPROPRIÉ POUR ARRÊTER LE FLUX D'AIR ET GARDER LE COMPRESSEUR EN POSITION D'ARRÊT OU DE VERROUILLAGE ET ÉTIQUETAGE QUAND ON ARRÊTE LE TRAVAIL.	NO FLY OF BURNING. DO NOT ADJUST REGULATORS TO RESULT IN THE OUTPUT PRESSURE GREATER THAN MARKED NOMINAL PRESSURE OF ATTACHMENT TO TOOL OR TANK.	RIESGO DE QUEMOS. NO AJUSTAR EL REGULADOR PARA OBTENER UNA PRESION DE SALIDA SUPERIOR A LA MARCADA NOMINAL MARCADA POR EL FABRICANTE. NO AJUSTAR EN UN LUGAR RESERVADO.	RIQUE D'ÉCHAUFFEMENT. NE PAS AJUSTER LE RÉGULATEUR POUR OBTENIR UNE PRESION DE SORTIE SUPÉRIEURE À LA MARQUE NOMINALE MARQUÉE SUR L'ACCESSOIRE. NE PAS AJUSTER EN UN LIEU RÉSERVÉ.	TO REMOVE THE AIR FROM AN ELECTRIC TOOL, DO NOT EXPOSE TO WATER. STOP WORK.	PARA QUITAR EL AIRE DE UNA HERRAMIENTA ELÉCTRICA, NO EXPOSER AL AGUA. DETENER EL TRABAJO.	POUR RÉGULER L'AIR D'UN Outils ÉLECTRIQUE, NE PAS L'EXPOSER À L'EAU. ARRÊTER LE TRAVAIL.	NO ELECTRICAL SHOCK. ALWAYS DISCONNECT FROM POWER SOURCE BEFORE SERVICE. COMPRESSOR MUST BE DEENERGIZED.	RIESGO DE CHOQUE ELÉCTRICO. SIEMPRE DESCONECTAR DEL FUENTE DE ENERGIA ANTES DE SERVICIO. EL COMPRESOR DEBE CONECTAR A TIERRA.	RIQUE D'ÉLECTROCUTION. TOUJOURS DÉCONNECTER L'APPAREIL DE L'ALIMENTATION ÉLECTRIQUE AVANT TOUT TRAVAIL. LE COMPRESSEUR DOIT ÊTRE MIS À LA TERRE.	THIS EQUIPMENT INCORPORATES PARTS, SUCH AS SWAP PARTS, REPAIRS AND THE LIKE THAT ARE NOT COVERED BY OUR WARRANTY. THESE PARTS ARE LOCATED IN A GARAGE. IT SHOULD BE IN A ROOM OR FACILITY PROVIDED FOR THE PURPOSE. WE DO NOT HAVE A RIGHT TO WORK ABOVE THE FLOOR.	ESTE EQUIPO INCLUYE PARTES COMO REPUESTAS, REPARACIONES Y SIMILARES QUE NO ESTÁN CUBIERTAS POR NUESTRO PROGRAMA DE GARANTIA. ESTAS PARTES SE ENCUENTRAN EN UNA SALA O HERRERIA DEDICADA PARA SU USO. NO TENEMOS DERECHO A TRABAJAR ENCIMA DEL PISO.	CECI EQUIPEMENT COMPREND DES PARTES, TELS QUE DES INTERCHANGIBLES ET COPIES REPARATION. CES COMPOSANTS ET CES REPARATIONS NE SONT PAS COUVERTES PAR NOTRE PROGRAMME DE GARANTIE. CES PARTES SONT LOCALISÉES DANS UNE SALLE OU UN BÂTIMENT DESTINÉ À CETTE FIN OU À UN BÂTIMENT ANNEXE AU DÉPÔT DE LA SALLE.	
⚠ WARNING	⚠ ADVERTENCIA	⚠ AVERTISSEMENT																											
READ MANUAL TO LOCATE THE PLACE OF ALL LABELS. USER MUST READ AND UNDERSTAND ALL INFORMATION PROVIDED ON ALL LABELS BEFORE ANY OPERATION.	LEER EL MANUAL PARA LOCALIZAR EL LUGAR DE TODOS LOS ETIQUETAS. EL USUARIO DEBE LEER Y ENTENDER EL MANUAL DEL OPERADOR ANTES DE CUALQUIER OPERACION DEL COMPRESOR DE AIRE.	LIRE LE MANUEL POUR LOCALISER LE LIEU DE TOUTES LES ETIQUETTES. L'UTILISATEUR DOIT LIRE ET COMPRENDRE LE MANUEL DE L'UTILISATEUR AVANT D'UTILISER LE COMPRESOR D'AIR.																											
WEAR EYE PROTECTION WHEN YOU WORK WITH AIR TOOLS.	USAR PROTECCION PARA LOS OJOS QUE CUMPLAN CON EL ESTANDAR ANSI Z87.1.	PORTER DES LUNETTES DE PROTECTION COMPORTANT LA MENTION DE CONFORMITE A LA NORME ANSI Z87.1.																											
NO FLY OF AIR. DO NOT DIRECT AIR STREAM AT BODY. DO NOT USE COMPRESSED AIR FOR BREATHING.	RIESGO DE LESIONES. NO DIRIGIR CORRIENTES DE AIRE HACIA EL CUERPO. NO UTILIZAR AIRE COMPRESOR PARA RESPIRAR.	RIQUE DE BLESSURE. NE PAS DIRIGER LE FLUX D'AIR VERS LE CORPS. NE PAS RESPIRER L'AIR COMPRIME.																											
NO FLY OF FIRE OR EXPLOSION. DO NOT TOUCH CHANGIBLE COILS IN A COMPRESSOR AREA. STOP WORK IMMEDIATELY IF YOU NOTICE DO NOT TOUCH WHILE SPRAYING OR PAINTING WORKS. DO NOT REMOVE OR DISCONNECT AIR HOSES FROM AIR TOOLS. ALWAYS WEAR USE AN APPROVATELY RATED STOP VALVE TO STOP THE AIR FLOW AND KEEP THE COMPRESSOR ON OFF OR LOCK OUT TAG OUT WHEN YOU STOP WORK.	RIESGO DE INCENDIO O EXPLOSION. NO TOQUE LAS bobinas intercambiables en un área cercana a la zona de la salida de flujo de aire. DETENER EL TRABAJO INMEDIATAMENTE SI SE OBSERVAN VERTIDOS O FUMOS. NO TOQUE MIENTRAS SE TRABAJA CON SPRAY O PINTURA. NO QUITAR NI DESCONECTAR LAS MANGUERAS DE LOS HERRAMIENTAS DE AIRE. SIEMPRE USAR UN VALVULA DE CIERRE APROPIADA PARA DETENER EL FLUJO DE AIRE Y MANTENER EL COMPRESOR EN LA POSICION DE APAGADO O BLOQUEADO Y ETIQUETADO CUANDO SE DETIENE EL TRABAJO.	RIQUE D'INCENDIE OU D'EXPLOSION. NE PAS TOUCHER DES bobines interchangeables dans la zone de flux d'air. ARRÊTER LE TRAVAIL EN CAS DE FUMÉE OU D'ÉMISSION DE BRÛLURE. NE PAS TOUCHER PENDANT LE TRAVAIL À L'AÉROSOIF OU À LA PEINTURE. NE PAS ENLEVER NI DÉCONNECTER LES TUYAUX D'AIR DES Outils À AIR. TOUJOURS UTILISER UN VANNEAU APPROPRIÉ POUR ARRÊTER LE FLUX D'AIR ET GARDER LE COMPRESSEUR EN POSITION D'ARRÊT OU DE VERROUILLAGE ET ÉTIQUETAGE QUAND ON ARRÊTE LE TRAVAIL.																											
NO FLY OF BURNING. DO NOT ADJUST REGULATORS TO RESULT IN THE OUTPUT PRESSURE GREATER THAN MARKED NOMINAL PRESSURE OF ATTACHMENT TO TOOL OR TANK.	RIESGO DE QUEMOS. NO AJUSTAR EL REGULADOR PARA OBTENER UNA PRESION DE SALIDA SUPERIOR A LA MARCADA NOMINAL MARCADA POR EL FABRICANTE. NO AJUSTAR EN UN LUGAR RESERVADO.	RIQUE D'ÉCHAUFFEMENT. NE PAS AJUSTER LE RÉGULATEUR POUR OBTENIR UNE PRESION DE SORTIE SUPÉRIEURE À LA MARQUE NOMINALE MARQUÉE SUR L'ACCESSOIRE. NE PAS AJUSTER EN UN LIEU RÉSERVÉ.																											
TO REMOVE THE AIR FROM AN ELECTRIC TOOL, DO NOT EXPOSE TO WATER. STOP WORK.	PARA QUITAR EL AIRE DE UNA HERRAMIENTA ELÉCTRICA, NO EXPOSER AL AGUA. DETENER EL TRABAJO.	POUR RÉGULER L'AIR D'UN Outils ÉLECTRIQUE, NE PAS L'EXPOSER À L'EAU. ARRÊTER LE TRAVAIL.																											
NO ELECTRICAL SHOCK. ALWAYS DISCONNECT FROM POWER SOURCE BEFORE SERVICE. COMPRESSOR MUST BE DEENERGIZED.	RIESGO DE CHOQUE ELÉCTRICO. SIEMPRE DESCONECTAR DEL FUENTE DE ENERGIA ANTES DE SERVICIO. EL COMPRESOR DEBE CONECTAR A TIERRA.	RIQUE D'ÉLECTROCUTION. TOUJOURS DÉCONNECTER L'APPAREIL DE L'ALIMENTATION ÉLECTRIQUE AVANT TOUT TRAVAIL. LE COMPRESSEUR DOIT ÊTRE MIS À LA TERRE.																											
THIS EQUIPMENT INCORPORATES PARTS, SUCH AS SWAP PARTS, REPAIRS AND THE LIKE THAT ARE NOT COVERED BY OUR WARRANTY. THESE PARTS ARE LOCATED IN A GARAGE. IT SHOULD BE IN A ROOM OR FACILITY PROVIDED FOR THE PURPOSE. WE DO NOT HAVE A RIGHT TO WORK ABOVE THE FLOOR.	ESTE EQUIPO INCLUYE PARTES COMO REPUESTAS, REPARACIONES Y SIMILARES QUE NO ESTÁN CUBIERTAS POR NUESTRO PROGRAMA DE GARANTIA. ESTAS PARTES SE ENCUENTRAN EN UNA SALA O HERRERIA DEDICADA PARA SU USO. NO TENEMOS DERECHO A TRABAJAR ENCIMA DEL PISO.	CECI EQUIPEMENT COMPREND DES PARTES, TELS QUE DES INTERCHANGIBLES ET COPIES REPARATION. CES COMPOSANTS ET CES REPARATIONS NE SONT PAS COUVERTES PAR NOTRE PROGRAMME DE GARANTIE. CES PARTES SONT LOCALISÉES DANS UNE SALLE OU UN BÂTIMENT DESTINÉ À CETTE FIN OU À UN BÂTIMENT ANNEXE AU DÉPÔT DE LA SALLE.																											

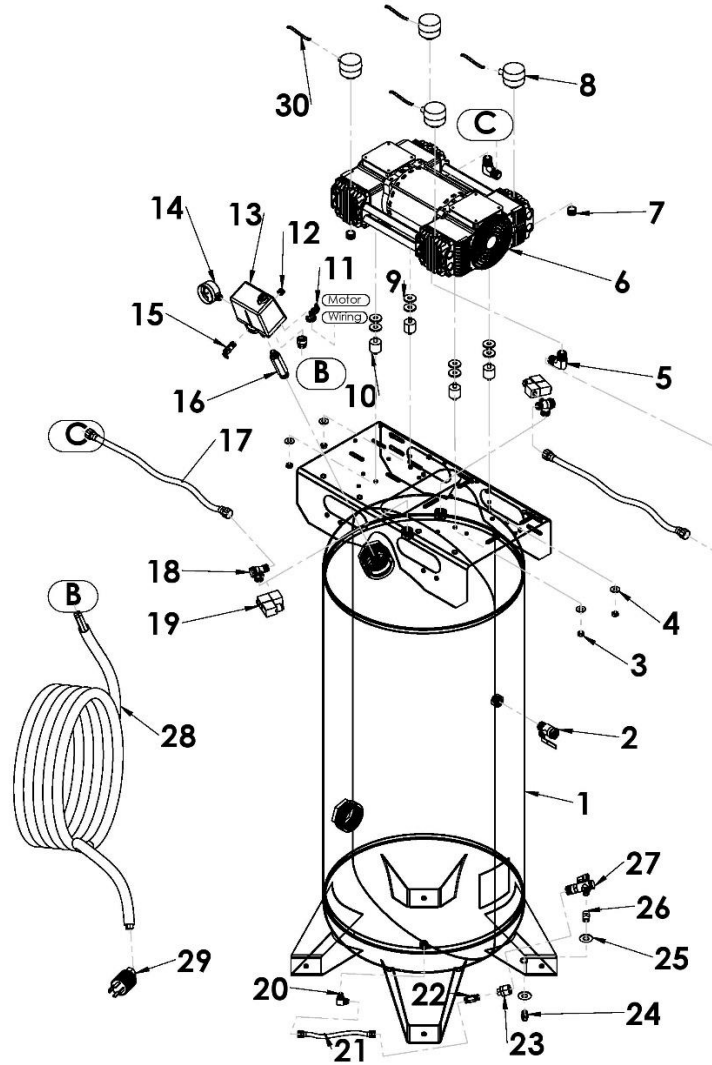

NO.	Part	NO.	Part
1	60 Gal. Steel Tank	21	Hose (L-A3) x 10" Long
2	1/2" NPT Ball Valve	22	1/4" NPT Connecting Bar MX
3	M8 Lock Nut	23	1/2-1/4" Reducer
4	M8 Washer	24	Male Connector 1/4"NPT x 8mm
5	1/2" x 3/8" NPT M Elbow	25	1/2" Stainless Steel Washer
6	6.5HP 3ph 4 piston motor	26	1/4" Coupler
7	2 HP Seal	27	Filter Ball Valve
8	Air Filter	28	Power Cord Cable 14AWG/4
9	Rubber Washer	29	NEMA L15-20 Plug (3 Phase)
10	Shock Strut	30	Air Filter Hose 8mm
11	Strain Relief 8N-2	31	
12	1 HP Seal	32	
13	Pressure Switch	33	
14	Pressure Gauge	34	
15	165 PSI Safety Valve	35	
16	Connecting Pipe 4"	36	
17	3/8" x 14" Hose	37	
18	Check Valve	38	
19	Electromagnetism 220V	39	
20	1/4" Elbow (L-A3)	40	

## PRE-OPERATION CHECKLIST

### Package Contents & Assembly

**Model: 60065C**

**Package contents:**

- Air Compressor
- Owner's Manual
- 4 Air Filters
- 4 Intake Tubes

### Assembly:

Install the four (4) Air Filters (1/2" NPT).

1. Attach the air filter to the motor head.
  - a. Screw the air filter into the 1/2" threaded motor head port. Repeat for the remaining 3 filters.
  - b. Attach the 4" intake tube (8 mm OD) to the 8 mm opening located on the side of each filter.

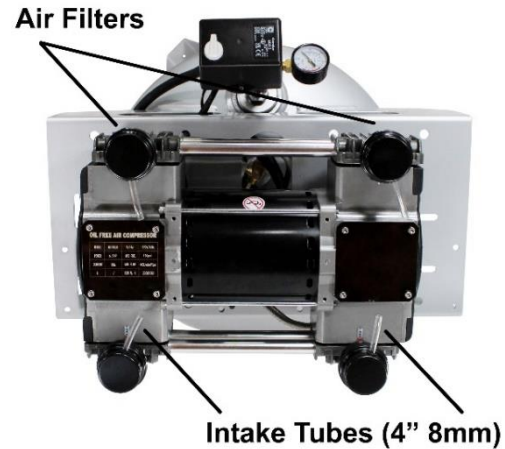
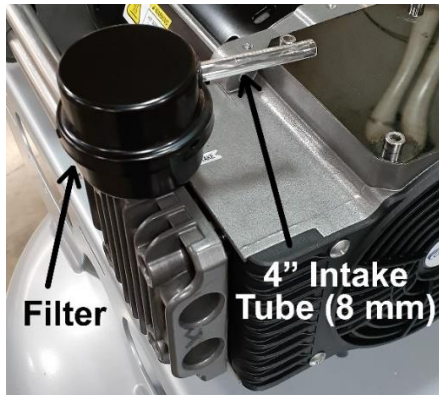

### Close Manual Ball Drain Valve:

1. Ensure the Manual Ball Drain Valve is closed prior to turning the air compressor on.

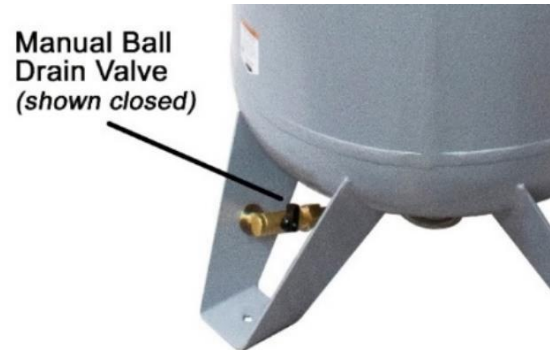

**NOTE:** To drain the air tank, turn the ball valve lever to be inline with tubing; water/air will eject from 8mm valve opening.

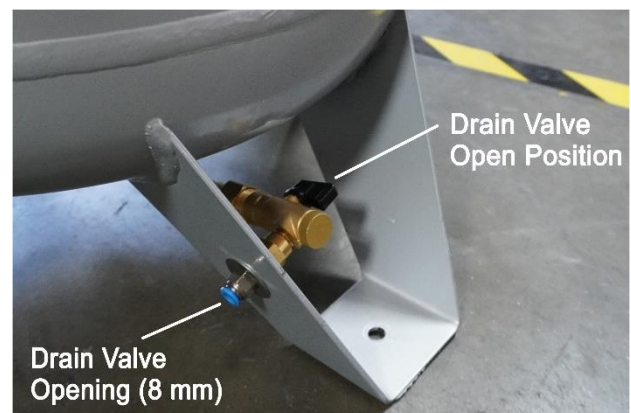



## Inspect for Damage

Before using the air compressor, make sure the air tank is not damaged, inspect all parts for damage, and check that all pipes are firmly connected.

Do not use the air compressor if any damage is found. If damaged, have an authorized service center inspect and test the air compressor to ensure that it is working properly.

## Save Packaging

**IMPORTANT:** Save all outside packaging in case you ever need to return the product for service or repair.

## Compressor Location

### Use on Flat Surface

For proper operation, the air compressor must be placed on a flat surface with an incline no greater than 15 degrees.

## Maintain a Clear Area

It is very important that the air compressor is positioned so that there is adequate airflow around the machine. There must be at least 2 feet of obstacle-free space surrounding and above the air compressor.

**⚠ WARNING**

  
**EXPLOSION**

  
**FIRE**

**Use caution to minimize risk of fire or explosion.**

**It is normal for the air compressor motor and pressure switch to produce sparks while operating. If sparks come in contact with vapors from gasoline or solvents, they may ignite and cause a fire or explosion.**

**Abrasive tools such as grinders, drills and other tools are capable of making sparks that can ignite flammable materials.**

**Always operate the air compressor a safe distance away from flammable items. Use in well-ventilated areas.**

**Never exceed the maximum rated pressure.**

**⚠ WARNING**



**RISK TO BREATHING**

**Dust or dust-like particulates caused by power-sanding, sawing, grinding, drilling or any other construction-like activities can contain contaminants that are harmful to breathe.**

**Always use your air compressor in a well-ventilated and clean area.**

**Never breathe the air that comes directly out of the air compressor or air hose. This air is not suitable for breathing.**

**Always wear approved safety equipment. When performing dust-creating activities, securely wear properly-fit face masks or respirators.**

**If you feel ill from breathing while operating your air compressor, stop and seek medical attention immediately.**

## Use in Areas with Clean Air

For proper operation and to maximize the longevity of the air compressor, it is very important that the air drawn into the air compressor is clean. The air compressor should not be used in areas where dust or particulates are in the air. This will damage the motor and impair proper operation.

**IMPORTANT:** Always use the air filter, properly installed.

## Electrical Power

### Electrical Power Requirements

Before using the air compressor, refer to the serial label for voltage and amperage requirements. Make sure you have a sufficient electrical supply for supporting the motor's requirements.

#### **⚠ DANGER**



SHOCK

There is a danger of electric shock.

Use only undamaged electrical cords.

DO NOT touch bare wires or receptacles.

DO NOT operate air compressor in wet weather or in wet conditions.

DO NOT touch air compressor or cords if hands or feet are wet.

Ensure that all cords are free of damage before connecting to the power supply.

Ensure that you have a sufficient electrical supply for supporting the requirements of the motor.

Improper installation of the grounding plug is able to result in a risk of electric shock. When repair or replacement of the cord or plug is required, do not connect the grounding wire to either flat terminal. The wire with insulation having an outer surface that is green with or without yellow stripes is the grounding wire.

This product must be grounded. In the event of an electrical short circuit, grounding reduces the risk of electrical shock by providing an escape wire for the electric current.

This product is equipped with a cord having a grounding wire with an appropriate grounding plug. The plug must be plugged into an outlet that is properly installed and grounded in accordance with the local codes and ordinances.

Use a dedicated 20 Amp Circuit: 230 Volts 60 Hertz  
**3-Phase 20 Amp Outlet** (range 215 to 240 volts 60 hz).

Low voltage and/or an overload circuit can cause the motor's overload protection system circuit breaker to trip.

### Electrical Extension Cords

#### **⚠ CAUTION**

Use caution when using extension cords.

If using an extension cord, use a heavy duty locking power cord, 4-prong, 20 AMP (L15-20P to L15-20R). 50 foot maximum is suggested.



As undersized cord results in a drop in the line voltage and loss of power and overheating.

When in doubt, use a heavier gauge. The smaller the gauge the more current the cord can carry.

Inspect all electrical extension cords to ensure that they are free of damage.

## OPERATING THE AIR COMPRESSOR

#### **⚠ WARNING**

This manual contains important instructions for operating this product. For your safety, and the safety of others, be sure to read this manual thoroughly before operating the product.

Failure to properly follow all the instructions and precautions can cause you and others to be seriously hurt or killed.

Save this manual for future reference.

### Introduction

This air compressor features a compact structure, stable performance, a high airflow rate, easy operation and maintenance. Because the air compressor produces no oil in the airflow, it can be used as an independent air supply machine for situations in which oil in the airflow is an issue. The motor directly drives the pistons and is able to function without lubrication for a long period of time.

### Assembly

1. Connect your air supply hose to the 1/2" NPT female port. Make sure the drainage valve is off and that the pressure switch is in the OFF position.
2. Ensure that the power supply you are going to use is operating normally. **230 Volts 60 Hertz 3-Phase**. 20 Amp Outlet (range 215v to 240v).
3. Insert the power supply cord into the power supply socket.

## Test Run

Before using the air compressor for the first time, complete a test run as follows:

1. Turn the power switch to the OFF position. Plug the power supply cord into a power supply socket. Start the air compressor by turning the power switch to the AUTO position. The pressure gauge reading will slowly rise as pressure increases inside the air tank. When the gauge reading reaches 120 PSI (plus or minus 5 PSI), the pressure switch will automatically turn the power off. This indicates the compressor is working normally.



2. Turn the power switch to the Off position, unplug the power supply cord and release the air in the air tank by opening the drain valve at the bottom of the tank. At this point proceed to the next step (daily operations).

**Note:** If the Air Compressor is not working properly, the pressure gauge will indicate that there is a decrease in pressure in the air tank. If there is an air leak from the compressor the pressure in the air tank decreases, the pressure switch resets and the motor automatically turns back on.

If you detect an air leakage, turn the power switch to the Off position, release the air from the tank by opening the Manual Ball drain valve at base of unit. Unplug the power supply cord and contact Customer Support for Assistance.

## Daily Operation

### Starting the compressor:

1. Turn the power switch to the OFF position.
2. Attach the air hose to the 1/2" female port.
3. Close the drain valve.
4. Ensure all 4 air filters are attached.
5. Plug the power supply cord into a power supply socket.
6. Turn the power switch to the AUTO position.
7. Let the motor run and tank fill until motor turns off.
8. To regulate the air flow:

An optional 0-90 PSI regulator will need to be purchased and installed – contact California Air Tools for information.

9. Operate air tool normally.

### Shutting down the compressor:

1. Turn the power switch to the OFF position.
2. Unplug the power supply cord.
3. Remove the pressure and water in the air tank through manual drain valve.

## ⚠ WARNING



### FLYING OBJECTS

**Flying object can cause injury to the eyes, head and other parts of the body.**

**Air-powered equipment and power tools are capable of propelling items (metal chips, fasteners and particulates) at high speed into the air and could result in injury.**

**Always wear approved head and eye protection.**

**Never point the air stream at any part of the body, or at another person or animal.**

**When operating the air compressor, make sure all other people and animals maintain a safe distance.**

**Do not move the air compressor when the air tank is under pressure.**

**Never use the air hoses to pull or move the air compressor.**

**Keep the air compressor on a flat surface.**

## ⚠ WARNING



### HOT SURFACE



### FIRE

**Air compressor surfaces become hot during operation.**

**DO NOT touch hot surfaces, because they can cause severe burns.**

**Do not touch the air compressor's cylinder head. During operation, the cooling fins of the cylinder head and delivery pipe become hot.**

**Allow the air compressor to cool before touching it.**

**DO NOT place a storage cover on the unit during operation. Only place a cover on the air compressor after it has thoroughly cooled down.**

## MAINTENANCE

### Draining the Air Tank

The frequency at which you should drain the air tank depends on the environmental conditions and the amount of operating time logged. The average draining frequency is every 1 to 2 days.

1. Place the air compressor above a container capable of holding water.
2. With compressed air in the air tank, slowly turn the drain valve knob to the forward (open) or straight position. The water in the air tank will drain out.
3. After all of the accumulated water has drained out, turn the drain valve knob to the closed or left position in order to avoid leakage.
4. Draining the air tank protects parts from rust and corrosion.

### Cleaning or Changing the Air Filter

The air filters are designed to reduce noise and help prevent particulates in the air from entering and damaging the air compressor.

After being used for a period of time, the air filter will become clogged. This will reduce the air intake capabilities of the air compressor, reducing performance. Therefore, the air filter must be cleaned or replaced regularly.

1. Open the lid on the air filter, then remove the air filter element.
2. To clean the element blow off or brush off the dirt and dust.
3. If clogged, replace with a new air filter.

### Testing for Leaks

Make sure all connections are tight. Do not overtighten.

A small leak in any hose or pipe connection will reduce the air compressor's performance.

To test for small leaks, spray a small amount of soapy water on the area suspected of leaking. If the soap bubbles, replace the broken part.

### Cleaning

Clean items with a soft brush, or wipe with a moistened cloth using a biodegradable solvent.

Do not use flammable liquids such as gasoline or alcohol. Always keep parts clean from dirt and dust for better performance.

### Pressure Switch

The pressure switch is factory pre-set to shut off at 120 PSI (plus or minus 5 PSI) and to re-start at 90 PSI (plus or minus 5 PSI)

### Service/Maintenance

It is recommended to replace four (4) piston seals (gaskets) inside the motor-pump after 2000 hours of operation. Visit [CaliforniaAirTools.com](http://CaliforniaAirTools.com) Maintenance-Troubleshooting page for instructions.

## STORAGE

Before storing for a prolonged period of time:

1. Turn off the power supply.
2. Disconnect the power cord from the power supply and wrap the power cord around the air compressor handle to reduce the risk of damage.
3. Pull the relief valve and release all the pressure from the air tank.
4. Clean the air compressor to remove all dirt and dust.
5. Cover the air compressor with a cover to protect the unit from dust and moisture.
6. Do not stack or store any items on top of or around the air compressor. Damage could occur.

## CAUTION

**TO REDUCE THE RISK OF ELECTRIC SHOCK,  
DO NOT EXPOSE TO RAIN.**

**STORE INDOORS.**

## TROUBLESHOOTING

PROBLEM	POSSIBLE CAUSE	POSSIBLE SOLUTIONS
Pressure drop in the tank.	Air leaks at connections.	Let the compressor build pressure in the tank, to the maximum pressure if possible. Brush soapy water on air connections and look carefully for air bubbles. Tighten leaky connections. If the problem persists, contact the seller for further advice.
The unloader valve leaks when the compressor is idle.	Unloader valve seal is defective.	Let the air in the air tank flow out until all the pressure is released. Then remove the unloader valve plug and clean the valve seal. If necessary, replace the seal and then reinstall all components.
The compressor stopped and does not start.	The thermal protector turned on because the motor is overheating.	Check that the main voltage corresponds to the air compressor specifications. An extension cord that is too thin or too long can cause a voltage drop and cause the motor to overheat. Excessive use (over 2 hours continuous use) can cause the motor to overheat Allow the motor to cool down.
	Motor windings are burned out.	Contact Customer Support.
The motor does not start and makes a humming noise.	Head Pressure	Do a Check Valve Adjustment. Drain air tank.
	Low voltage supply to the motor. (see below)	Remove check valve cap Take out check valve spring Clean inside the check valve and elongate the spring. Replace spring and cap
The motor does not start or starts slowly.	Low voltage supply to the motor.	Check that the main voltage corresponds to the air compressor specifications. An extension cord that is too thin or too long can cause a voltage drop.. Use heavy duty extension cords. Ensure that the air compressor is plugged into a fully functional power outlet
The compressor is noisy with metallic clangs.	Compressor head gasket or reed valve is damaged	Stop the compressor and contact the dealer.
The compressor does not reach the maximum pressure.	Compressor head gasket or reed valve is faulty.	Stop the compressor and contact the dealer.
The compressor doesn't seem to provide as much air as it did when new and/or the compressor cuts off within a much shorter time period.	The pressure switch needs adjusting.	Stop the compressor and contact the dealer.
	The tank is full of water due to condensation.	Open the drain valve and release the water from the tank.
The motor pump unit does not stop when the tank pressure reaches its maximum working pressure (120 PSI).(plus or minus 5 PSI)	Pressure switch defective or needs adjusting.	Stop the compressor immediately and contact Customer Support.

## SPECIFICATIONS

### Electrical Circuit (generic)

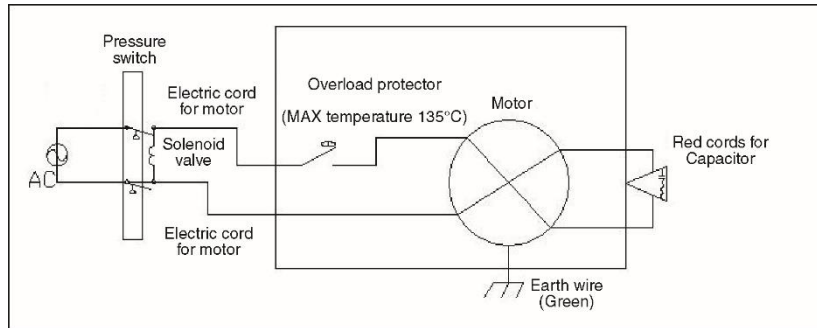

### Air Passage Drawing (generic)

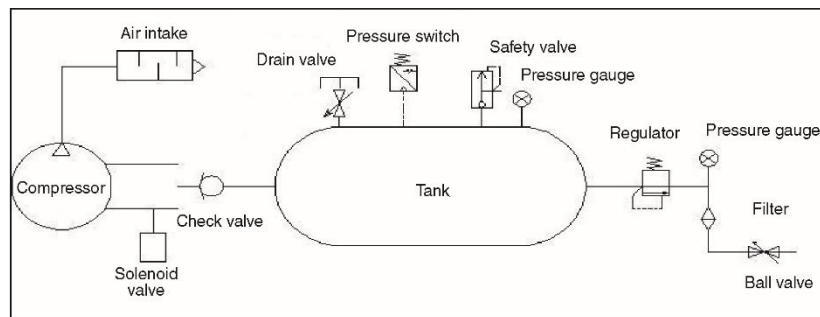

## CALIFORNIA AIR TOOLS INC. LIMITED WARRANTY

This warranty is limited to Air Compressors distributed by:

California Air Tools, Inc.  
8560 Siempre Viva Road  
San Diego, CA 92154

### Limited Warranty

California Air Tools Inc. will repair or replace, free of charge, to the original retail customer who purchased a California Air Tools, Inc. Air Compressor from an authorized dealer, distributor or distributor's dealer in North America.

This warranty does not transfer to subsequent owners.

California Air Tools Inc. will repair or replace, at its option, any parts of the portable air compressor that are proven by an authorized service center to be defective in material or workmanship under normal use during the applicable warranty time period as stated below. This limited warranty covers the cost of the replacement parts and labor for all defects when installed by an authorized service center. Transportation charges are the responsibility of the customer. Any part replaced under warranty becomes the property of California Air Tools Inc.

All parts replaced under warranty will be considered as part of original product, and any warranty on those parts will expire coincident with the original product warranty.

### Limited Warranty Periods

Non-commercial / Non-rental (personal use by a retail customer): 1 year parts and labor  
Commercial / Rental (usage for income, business use): 1 year parts and labor

The limited warranty period begins on the date of retail purchase by the original purchaser.

### Disclaimers, Limitations of Remedies & Exclusions

This warranty gives you specific legal rights, and you may also have other rights which may vary from state to state.

#### Disclaimer of Other Warranties

To the fullest extent permitted by applicable law, this limited warranty is exclusive and expressly in lieu of any and all other warranties, including, without limitation, any implied warranties of merchantability or fitness for a particular purpose or any other implied warranties that may arise from the course of dealing or usage of the trade. California Air Tools Inc. hereby disclaims and excludes all other warranties. To the extent that California Air Tools Inc. products are consumer products under applicable federal and state law with respect to any customer, the duration of any implied warranties (including but not limited to implied warranties of merchantability or fitness for a particular purpose) are limited to the shortest duration permitted by applicable law or the Limited Warranty period provided herein, whichever is longer.

#### Limitations of Remedies

California Air Tools Inc. shall not be liable to customer, or anyone claiming under customer, for any other obligations or liabilities, including but not limited to, obligations or liabilities arising out of breach of contract or warranty, negligence or other tort or any theory of strict liability, with respect to the air compressor or California Air Tools Inc. acts or omissions or otherwise. To the fullest extent permitted by applicable law, California Air Tools Inc. shall not in any event be liable for incidental, compensatory, punitive, consequential, indirect, special or other damages, including but not limited to loss of use, loss of income, loss of time, loss of sales, injury to personal property, or liability customer incurs with respect to any other person, or any other type or form of consequential damage or economic loss.

## Exclusions

In addition to the foregoing disclaimers, limitations and terms, this limited warranty shall not apply to and does not cover accessories, nor does it cover products that are in any way subject to any of the following:

1. Improper setup, installation or storage.
2. Lack of proper maintenance and service.
3. Accident, damage, abuse or misuse.
4. Abnormal operating conditions or applications.
5. Repair or modification by customer or any third party without written consent of California Air Tools Inc.
6. Use under operating conditions or in applications not recommended by California Air Tools Inc.
7. Normal wear.
8. The use of accessories or attachments not recommended by California Air Tools Inc.
9. Acts of God.

The application of these exclusions will be determined at the sole discretion of California Air Tools Inc.

## Registration

Warranty registration with California Air Tools Inc. is required on all products. You can mail the enclosed registration form or register on-line.

## Maintenance & Troubleshooting Guide

California Air Tools provides Maintenance & Troubleshooting Guide on our website [WWW.CALIFORNIAAIRTOOLS.COM](http://WWW.CALIFORNIAAIRTOOLS.COM). Valuable information regarding set-up, operation and maintenance. Please visit our website and view these videos for beneficial information.

## Service or Parts

Warranty is also available by keeping and showing your original receipt from the date of purchase to an Authorized California Air Tools Service Center.

For all customer service inquiries call 1-866-409-4581 or visit

[WWW.CALIFORNIAAIRTOOLS.COM](http://WWW.CALIFORNIAAIRTOOLS.COM)

Go to the “Contact Us” Tab

Click on “Service & Parts” Buttons for the Fastest Service.