

Atlas Copco

Oil-injected rotary screw compressors



GA 18 VSD+, GA 22 VSD+, GA 26 VSD+, GA 30 VSD+, GA 37 VSD+

Instruction book

Atlas Copco

Atlas Copco

Oil-injected rotary screw compressors

GA 18 VSD+, GA 22 VSD+, GA 26 VSD+, GA 30 VSD+, GA 37 VSD+

From following serial No. onwards: API 822 000

Instruction book

Original instructions

Copyright notice

Any unauthorized use or copying of the contents or any part thereof is prohibited.

This applies in particular to trademarks, model denominations, part numbers and drawings.

This instruction book is valid for CE as well as non-CE labelled machines. It meets the requirements for instructions specified by the applicable European directives as identified in the Declaration of Conformity.

2013 - 10

No. 2920 7110 00

www.atlascopco.com



Table of contents

1	Safety precautions.....	5
1.1	SAFETY ICONS.....	5
1.2	SAFETY PRECAUTIONS, GENERAL.....	5
1.3	SAFETY PRECAUTIONS DURING INSTALLATION.....	6
1.4	SAFETY PRECAUTIONS DURING OPERATION.....	7
1.5	SAFETY PRECAUTIONS DURING MAINTENANCE OR REPAIR.....	8
2	General description.....	10
2.1	INTRODUCTION.....	10
2.2	FLOW DIAGRAM.....	14
2.3	CONDENSATE SYSTEM.....	16
2.4	REGULATING SYSTEM.....	18
2.5	ELECTRICAL SYSTEM.....	19
2.6	AIR DRYER.....	20
3	Elektronikon® Graphic controller.....	22
3.1	ELEKTRONIKON® GRAPHIC CONTROLLER.....	22
3.2	CONTROL PANEL.....	24
3.3	ICONS USED.....	25
3.4	MAIN SCREEN.....	29
3.5	CALLING UP MENUS.....	33
3.6	INPUTS MENU.....	34
3.7	OUTPUTS MENU.....	37
3.8	COUNTERS.....	38
3.9	CONTROL MODE SELECTION.....	40
3.10	SERVICE MENU.....	42
3.11	MODIFYING THE SETPOINT.....	46
3.12	EVENT HISTORY MENU.....	48

3.13	MODIFYING GENERAL SETTINGS.....	49
3.14	INFO MENU.....	51
3.15	WEEK TIMER MENU.....	52
3.16	TEST MENU.....	61
3.17	USER PASSWORD MENU.....	63
3.18	WEB SERVER.....	64
3.19	PROGRAMMABLE SETTINGS.....	72
4	Installation.....	75
4.1	DIMENSION DRAWINGS.....	75
4.2	INSTALLATION PROPOSAL.....	78
4.3	ELECTRICAL CONNECTIONS.....	80
4.4	PICTOGRAPHS.....	84
5	Operating instructions.....	85
6	Maintenance.....	90
6.1	PREVENTIVE MAINTENANCE SCHEDULE.....	90
6.2	OIL SPECIFICATIONS.....	93
6.3	DRIVE MOTOR	94
6.4	AIR FILTER.....	94
6.5	OIL, OIL FILTER AND OIL SEPARATOR CHANGE.....	95
6.6	COOLERS.....	97
6.7	DRYER MAINTENANCE INSTRUCTIONS.....	98
6.8	SAFETY VALVES.....	99
6.9	SERVICE KITS.....	99
6.10	STORAGE AFTER INSTALLATION.....	99
6.11	DISPOSAL OF USED MATERIAL.....	100
7	Problem solving.....	101

8	Technical data.....	106
8.1	READINGS ON DISPLAY.....	106
8.2	ELECTRIC CABLE SIZE AND FUSES.....	107
8.3	REFERENCE CONDITIONS AND LIMITATIONS.....	114
8.4	COMPRESSOR DATA.....	114
8.5	TECHNICAL DATA ELEKTRONIKON® CONTROLLER.....	117
9	Instructions for use.....	119
10	Guidelines for inspection.....	120
11	Pressure equipment directives.....	121
12	Declaration of conformity.....	122

1 Safety precautions

1.1 Safety icons

Explanation

	Danger for life
	Warning
	Important note

1.2 Safety precautions, general

General precautions

1. The operator must employ safe working practices and observe all related work safety requirements and regulations.
2. If any of the following statements does not comply with the applicable legislation, the stricter of the two shall apply.
3. Installation, operation, maintenance and repair work must only be performed by authorized, trained, specialized personnel.
4. The compressor is not considered capable of producing air of breathing quality. For air of breathing quality, the compressed air must be adequately purified according to the applicable legislation and standards.
5. Before any maintenance, repair work, adjustment or any other non-routine checks, stop the compressor, press the emergency stop button, switch off the voltage and depressurize the compressor. In addition, the power isolating switch must be opened and locked.

The units are powered by a frequency converter, wait 10 minutes before starting any electrical repair.

	In a domestic environment, this product may cause radio interference in which case supplementary mitigation measures are required.
---	--

	If the machine is equipped with an automatic restart after voltage failure function and if this function is active, be aware that the machine will restart automatically when the power is restored if it was running when the power was interrupted!
---	---

6. Never play with compressed air. Do not apply the air to your skin or direct an air stream at people. Never use the air to clean dirt from your clothes. When using the air to clean equipment, do so with extreme caution and wear eye protection.
7. The owner is responsible for maintaining the unit in safe operating condition. Parts and accessories shall be replaced if unsuitable for safe operation.
8. It is not allowed to walk or stand on the unit or on its components.

1.3 Safety precautions during installation



All responsibility for any damage or injury resulting from neglecting these precautions, or non observance of the normal caution and care required for installation, operation, maintenance and repair, even if not expressly stated, will be disclaimed by the manufacturer.

Precautions during installation

1. The machine must only be lifted using suitable equipment in accordance with the applicable safety regulations. Loose or pivoting parts must be securely fastened before lifting. It is strictly forbidden to dwell or stay in the risk zone under a lifted load. Lifting acceleration and deceleration must be kept within safe limits. Wear a safety helmet when working in the area of overhead or lifting equipment.
2. The unit is designed for indoor use. If the unit is installed outdoors, special precautions must be taken; consult your supplier.
3. In case the device is a compressor, place the machine where the ambient air is as cool and clean as possible. If necessary, install a suction duct. Never obstruct the air inlet. Care must be taken to minimize the entry of moisture at the inlet air.
4. Any blanking flanges, plugs, caps and desiccant bags must be removed before connecting the pipes.
5. Air hoses must be of correct size and suitable for the working pressure. Never use frayed, damaged or worn hoses. Distribution pipes and connections must be of the correct size and suitable for the working pressure.
6. In case the device is a compressor, the aspirated air must be free of flammable fumes, vapors and particles, e.g. paint solvents, that can lead to internal fire or explosion.
7. In case the device is a compressor, arrange the air intake so that loose clothing worn by people cannot be drawn in.
8. Ensure that the discharge pipe from the compressor to the aftercooler or air net is free to expand under heat and that it is not in contact with or close to flammable materials.
9. No external force may be exerted on the air outlet valve; the connected pipe must be free of strain.
10. If remote control is installed, the machine must bear a clear sign stating: DANGER: This machine is remotely controlled and may start without warning.
The operator has to make sure that the machine is stopped and depressurized and that the electrical isolating switch is open, locked and labelled with a temporary warning before any maintenance or repair. As a further safeguard, persons switching on or off remotely controlled machines shall take adequate precautions to ensure that there is no one checking or working on the machine. To this end, a suitable notice shall be affixed to the start equipment.
11. Air-cooled machines must be installed in such a way that an adequate flow of cooling air is available and that the exhausted air does not recirculate to the compressor air inlet or cooling air inlet.
12. The electrical connections must correspond to the applicable codes. The machines must be earthed and protected against short circuits by fuses in all phases. A lockable power isolating switch must be installed near the compressor.
13. On machines with automatic start/stop system or if the automatic restart function after voltage failure is activated, a sign stating "This machine may start without warning" must be affixed near the instrument panel.
14. In multiple compressor systems, manual valves must be installed to isolate each compressor. Non-return valves (check valves) must not be relied upon for isolating pressure systems.
15. Never remove or tamper with the safety devices, guards or insulation fitted on the machine. Every pressure vessel or auxiliary installed outside the machine to contain air above atmospheric pressure must be protected by a pressure relieving device or devices as required.

16. Piping or other parts with a temperature in excess of 70°C (158°F) and which may be accidentally touched by personnel in normal operation must be guarded or insulated. Other high temperature piping must be clearly marked.
17. For water-cooled machines, the cooling water system installed outside the machine has to be protected by a safety device with set pressure according to the maximum cooling water inlet pressure.
18. If the ground is not level or can be subject to variable inclination, consult the manufacturer.
19. If the device is a dryer and no free extinguishing system is present in the air net close to the dryer, safety valves must be installed in the vessels of the dryer.



Also consult following safety precautions: [Safety precautions during operation](#) and [Safety precautions during maintenance](#).

These precautions apply to machinery processing or consuming air or inert gas.

Processing of any other gas requires additional safety precautions typical to the application which are not included herein.

Some precautions are general and cover several machine types and equipment; hence some statements may not apply to your machine.

1.4 Safety precautions during operation



All responsibility for any damage or injury resulting from neglecting these precautions, or non observance of the normal caution and care required for installation, operation, maintenance and repair, even if not expressly stated, will be disclaimed by the manufacturer.

Precautions during operation

1. Never touch any piping or components of the compressor during operation.
2. Use only the correct type and size of hose end fittings and connections. When blowing through a hose or air line, ensure that the open end is held securely. A free end will whip and may cause injury. Make sure that a hose is fully depressurized before disconnecting it.
3. Persons switching on remotely controlled machines shall take adequate precautions to ensure that there is no one checking or working on the machine. To this end, a suitable notice shall be affixed to the remote start equipment.
4. Never operate the machine when there is a possibility of taking in flammable or toxic fumes, vapors or particles.
5. Never operate the machine below or in excess of its limit ratings.
6. Keep all bodywork doors shut during operation. The doors may be opened for short periods only, e.g. to carry out routine checks. Wear ear protectors when opening a door.
On compressors without bodywork, wear ear protection in the vicinity of the machine.
7. People staying in environments or rooms where the sound pressure level reaches or exceeds 80 dB(A) shall wear ear protectors.
8. Periodically check that:
 - All guards are in place and securely fastened
 - All hoses and/or pipes inside the machine are in good condition, secure and not rubbing
 - No leaks occur
 - All fasteners are tight
 - All electrical leads are secure and in good order
 - Safety valves and other pressure relief devices are not obstructed by dirt or paint
 - Air outlet valve and air net, i.e. pipes, couplings, manifolds, valves, hoses, etc. are in good repair, free of wear or abuse

- Air cooling filters of the electrical cabinet are not clogged
9. If warm cooling air from compressors is used in air heating systems, e.g. to warm up a workroom, take precautions against air pollution and possible contamination of the breathing air.
 10. On water-cooled compressors using open circuit cooling towers, protective measures must be taken to avoid the growth of harmful bacteria such as *Legionella pneumophila* bacteria.
 11. Do not remove any of, or tamper with, the sound-damping material.
 12. Never remove or tamper with the safety devices, guards or insulations fitted on the machine. Every pressure vessel or auxiliary installed outside the machine to contain air above atmospheric pressure shall be protected by a pressure relieving device or devices as required.
 13. Yearly inspect the air receiver. Minimum wall thickness as specified in the instruction book must be respected. Local regulations remain applicable if they are more strict.



Also consult following safety precautions: [Safety precautions during installation](#) and [Safety precautions during maintenance](#).
 These precautions apply to machinery processing or consuming air or inert gas. Processing of any other gas requires additional safety precautions typical to the application which are not included herein.
 Some precautions are general and cover several machine types and equipment; hence some statements may not apply to your machine.

1.5 Safety precautions during maintenance or repair



All responsibility for any damage or injury resulting from neglecting these precautions, or non observance of the normal caution and care required for installation, operation, maintenance and repair, even if not expressly stated, will be disclaimed by the manufacturer.

Precautions during maintenance or repair

1. Always use the correct safety equipment (such as safety glasses, gloves, safety shoes, etc.).
2. Use only the correct tools for maintenance and repair work.
3. Use only genuine spare parts.
4. All maintenance work shall only be undertaken when the machine has cooled down.
5. A warning sign bearing a legend such as "Work in progress; do not start" shall be attached to the starting equipment.
6. Persons switching on remotely controlled machines shall take adequate precautions to ensure that there is no one checking or working on the machine. To this end, a suitable notice shall be affixed to the remote start equipment.
7. Close the compressor air outlet valve and depressurize the compressor before connecting or disconnecting a pipe.
8. Before removing any pressurized component, effectively isolate the machine from all sources of pressure and relieve the entire system of pressure.
9. Never use flammable solvents or carbon tetrachloride for cleaning parts. Take safety precautions against toxic vapours of cleaning liquids.
10. Scrupulously observe cleanliness during maintenance and repair. Keep dirt away by covering the parts and exposed openings with a clean cloth, paper or tape.
11. Never weld or perform any operation involving heat near the oil system. Oil tanks must be completely purged, e.g. by steam cleaning, before carrying out such operations. Never weld on, or in any way modify, pressure vessels.

12. Whenever there is an indication or any suspicion that an internal part of a machine is overheated, the machine shall be stopped but no inspection covers shall be opened before sufficient cooling time has elapsed; this to avoid the risk of spontaneous ignition of the oil vapour when air is admitted.
13. Never use a light source with open flame for inspecting the interior of a machine, pressure vessel, etc.
14. Make sure that no tools, loose parts or rags are left in or on the machine.
15. All regulating and safety devices shall be maintained with due care to ensure that they function properly. They may not be put out of action.
16. Before clearing the machine for use after maintenance or overhaul, check that operating pressures, temperatures and time settings are correct. Check that all control and shut-down devices are fitted and that they function correctly. If removed, check that the coupling guard of the compressor drive shaft has been reinstalled.
17. Every time the separator element is renewed, examine the discharge pipe and the inside of the oil separator vessel for carbon deposits; if excessive, the deposits should be removed.
18. Protect the motor, air filter, electrical and regulating components, etc. to prevent moisture from entering them, e.g. when steam cleaning.
19. Make sure that all sound-damping material and vibration dampers, e.g. damping material on the bodywork and in the air inlet and outlet systems of the compressor, is in good condition. If damaged, replace it by genuine material from the manufacturer to prevent the sound pressure level from increasing.
20. Never use caustic solvents which can damage materials of the air net, e.g. polycarbonate bowls.
21. **The following safety precautions are stressed when handling refrigerant:**
 - Never inhale refrigerant vapours. Check that the working area is adequately ventilated; if required, use breathing protection.
 - Always wear special gloves. In case of refrigerant contact with the skin, rinse the skin with water. If liquid refrigerant contacts the skin through clothing, never tear off or remove the latter; flush abundantly with fresh water over the clothing until all refrigerant is flushed away; then seek medical first aid.



Also consult following safety precautions: [Safety precautions during installation](#) and [Safety precautions during operation](#).

These precautions apply to machinery processing or consuming air or inert gas. Processing of any other gas requires additional safety precautions typical to the application which are not included herein.

Some precautions are general and cover several machine types and equipment; hence some statements may not apply to your machine.

2 General description

2.1 Introduction

Introduction

GA 18 VSD+ up to GA 37 VSD+ are single-stage, oil-injected screw compressors driven by an interior permanent magnet motor (IPM).

The compressors are controlled by the Atlas Copco Elektronikon® Graphic regulator (ER).

The regulator is fitted to the front panel. An electric cabinet (1) comprising fuses, transformers, relays, etc. is located behind this panel.

The compressors use VSD (Variable Speed Drive) technology. This means: automatic adjustment of the motor speed, depending on the compressed air demand.

The compressors are air-cooled and are enclosed in a sound-insulated bodywork.

GA Workplace

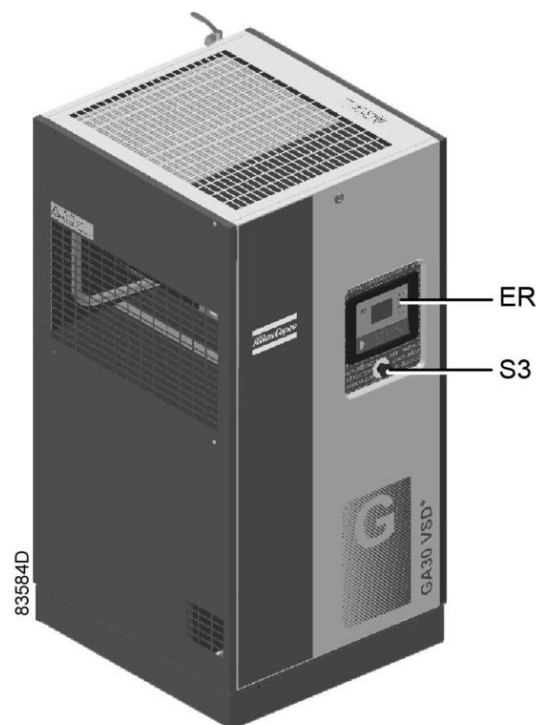

Front view, GA VSD+ Workplace

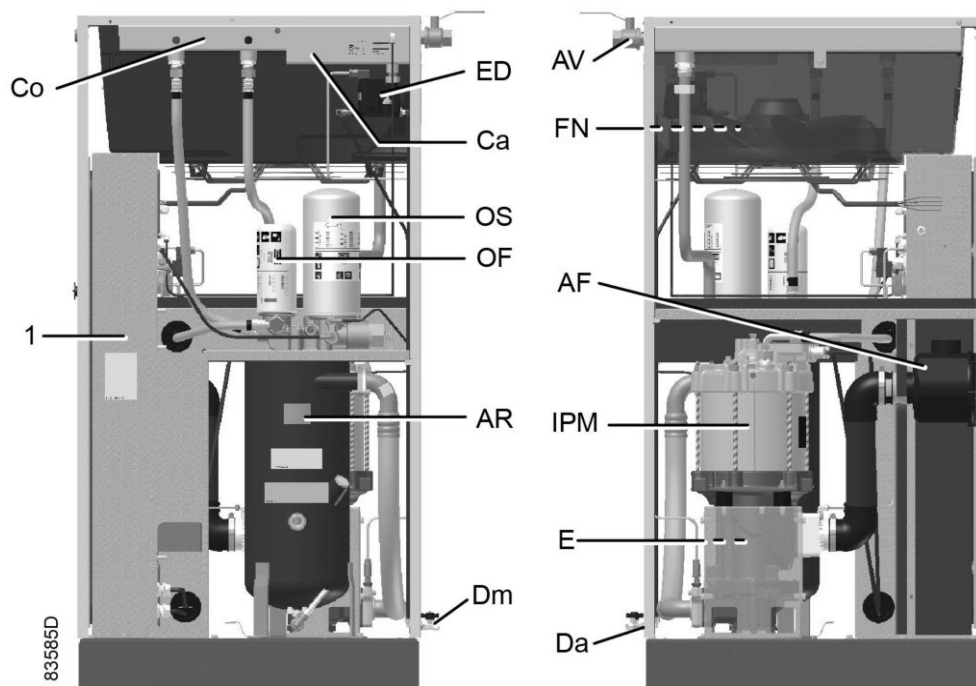

Open side view, GA VSD+ Workplace

GA Workplace Full-Feature

The Workplace Full Feature compressors have an air dryer which is integrated in the sound-insulated bodywork. The dryer removes condensate from the compressed air by cooling the air to near freezing point.

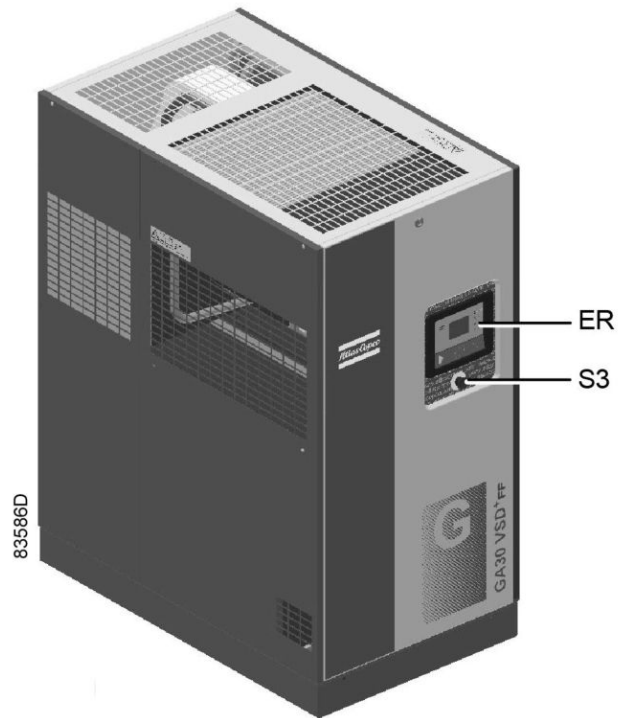

Front view, GA VSD+ Workplace Full-Feature

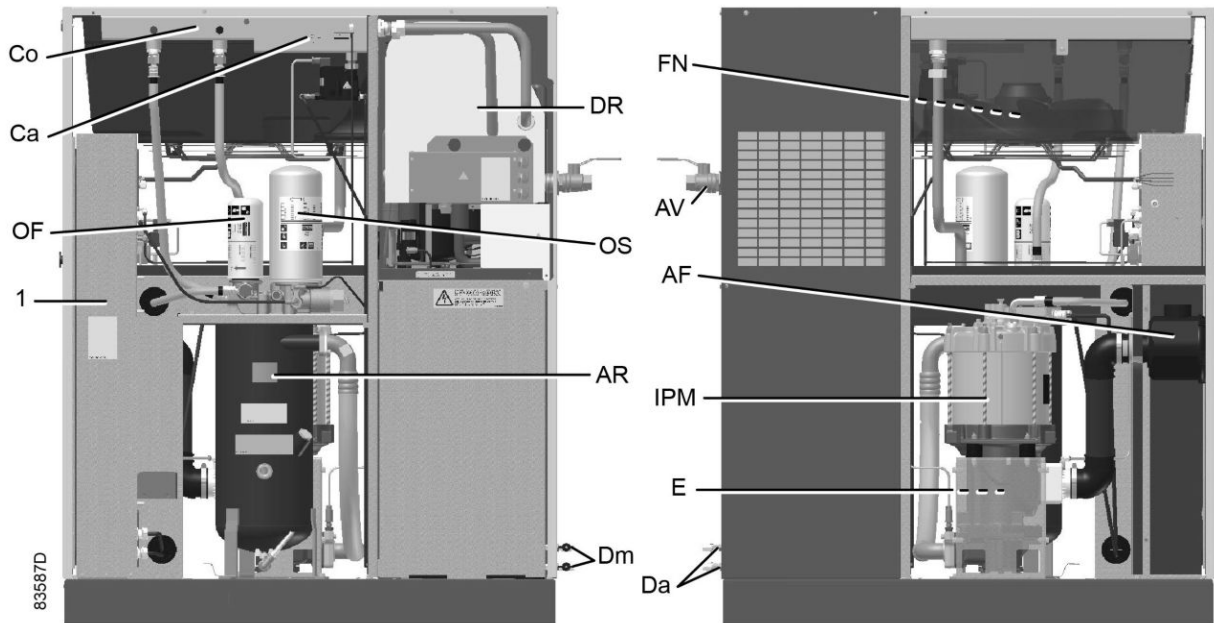

Open side view, GA VSD+ Workplace Full-Feature

Reference	Name
AF	Air filter
AR	Air receiver
AV	Air outlet
Ca	Air cooler

Reference	Name
Co	Oil cooler
Da	Automatic condensate outlet
Dm	Manual condensate outlet
DR	Refrigerant dryer
E	Compressor element
ED	Electronic water drain
ER	Elektronikon® Graphic controller
FN	Cooling fan
IPM	Drive motor
OF	Oil filter
OS	Oil separator
S3	Emergency stop button
1	Electric cabinet

2.2 Flow diagram

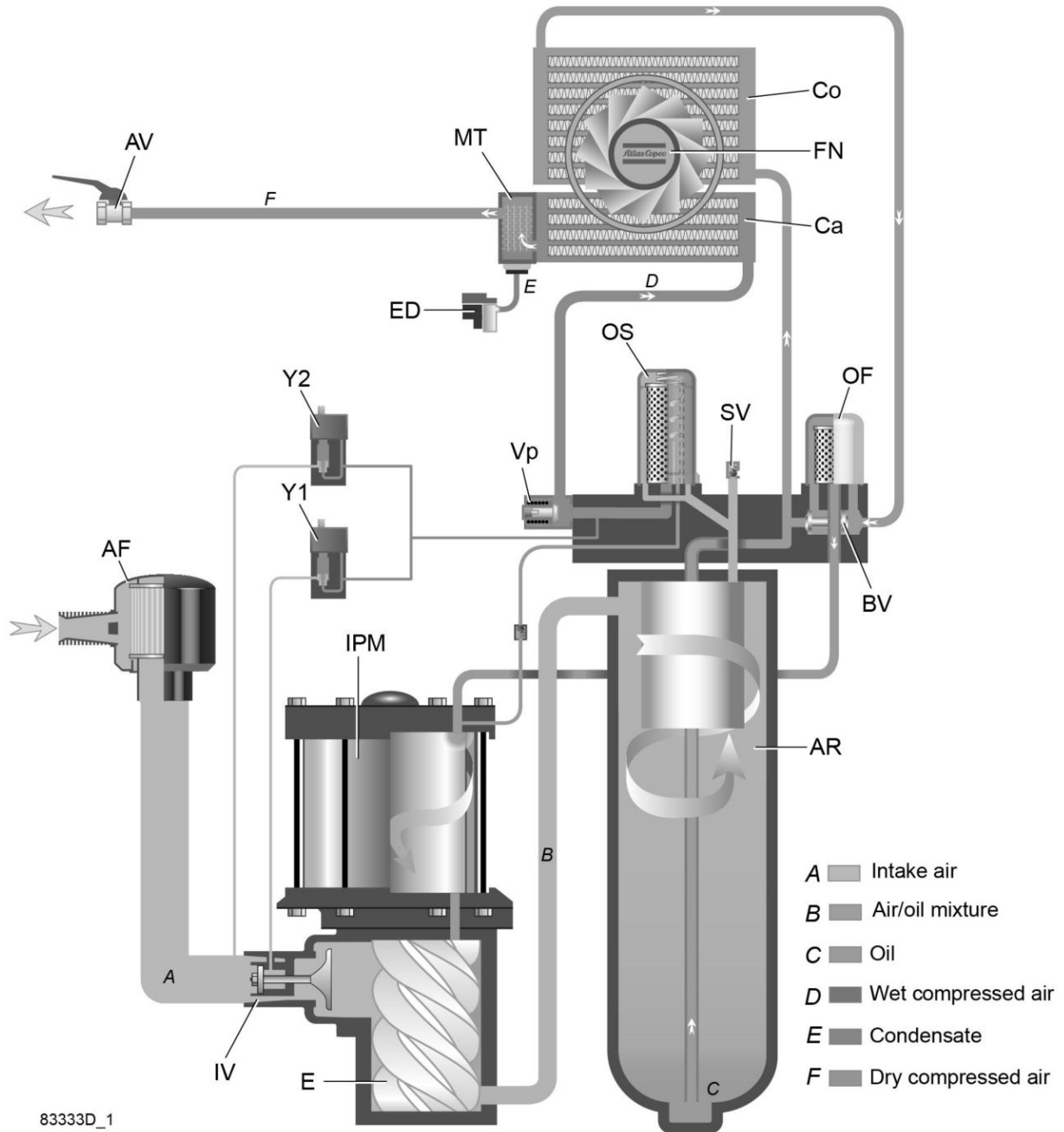

83333D_1

GA 18 VSD+ up to GA 37 VSD+ Workplace

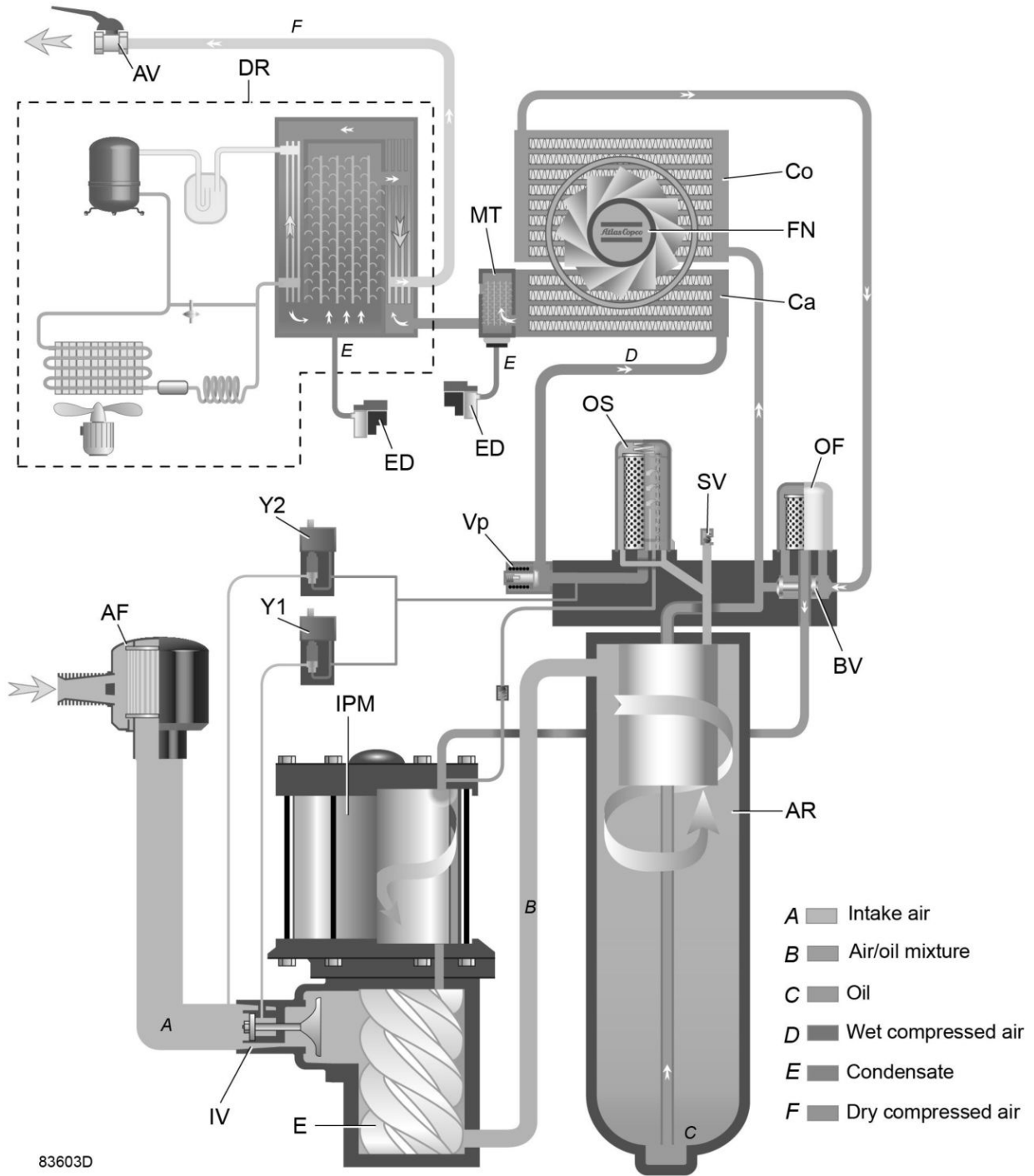

83603D

GA 18 VSD+ up to GA 37 VSD+ Workplace Full-Feature

Reference	Description
A	Air inlet
B	Air/oil mixture
C	Oil
D	Wet compressed air
E	Condensate

Reference	Description
F	Dry compressed air (Full-Feature)

Air flow

Air comes in through filter (AF) and inlet valve (IV) and is compressed in the compressor element (E).

A mixture of compressed air and oil flows into the air receiver/oil separator (AR).

The air flows through the minimum pressure valve (Vp), the air cooler (Ca) and the condensate trap (MT) to the outlet valve (AV).

Minimum pressure valve (Vp) prevents the receiver pressure from dropping below a minimum pressure and includes a check valve which prevents blow-back of compressed air from the net.

Full-Feature compressors have a dryer (DR) after the air cooler.

Oil circuit

The air receiver (AR) removes most of the oil from the air/oil mixture by centrifugal action. The oil separator (OS) removes the remaining oil. The oil collects in the lower part of the air receiver (AR) which serves as oil tank.

The oil system has a thermostatic bypass valve (BV).

When the oil temperature is below 71 °C (160 °F), the bypass valve shuts off the oil supply to the oil cooler (Co).

Air pressure forces the oil from air receiver (AR) through the oil filter (OF). The oil cooler (Co) is bypassed.

When the oil temperature has increased up to 71 °C (160 °F), bypass valve (BV) starts opening the supply to the oil cooler (Co). At approx. 85 °C (185 °F), all the oil flows through the oil cooler.

The filtered oil flows through the cooling channels of the permanent magnetic motor (IPM) into the compressor element (E).

Cooling

The cooling system has an air cooler (Ca) and an oil cooler (Co).

The fan (FN) blows air over the coolers. This fan is set on and off, depending on the operating conditions, according to a specific algorithm.

2.3 Condensate system

Drain connections

The compressors have an electronic water drain (ED).

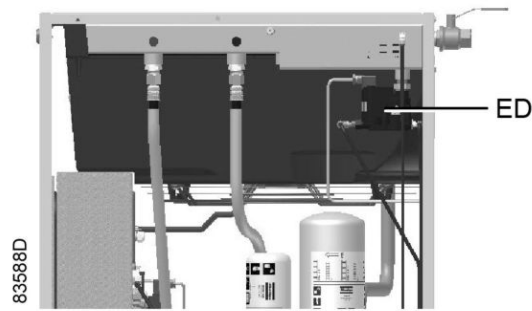

Location of electronic water drain (Workplace)

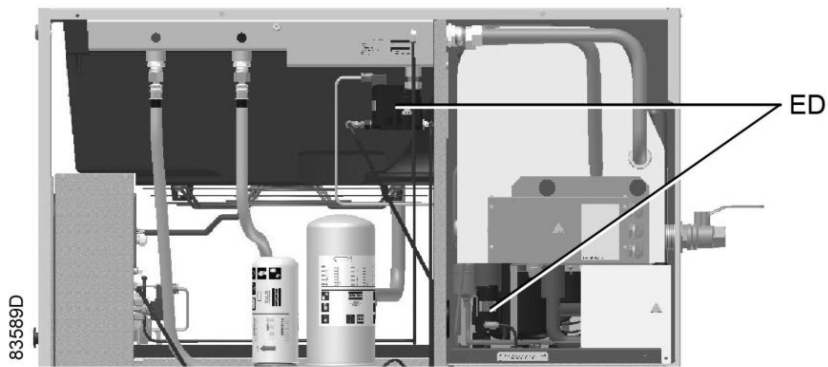

Location of electronic water drain (Workplace Full-Feature)

The water in the air condenses in the collector of the air cooler. When the condensate comes to a certain level, it drains through the automatic drain outlet (Da).

On a GA Workplace Full-Feature, the water in the air also condenses in the separator of the heat exchanger/evaporator. When the condensate comes to a certain level, it drains through the automatic drain outlet (Da).



Condensate drain connections, GA Workplace

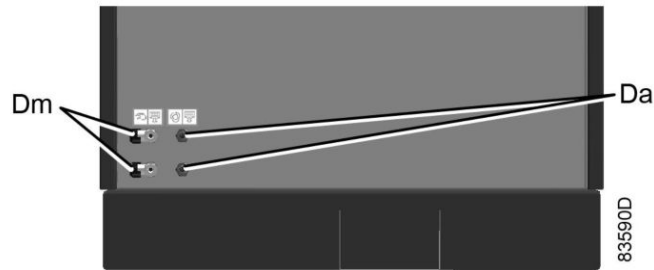

Condensate drain connections, GA workplace Full-Feature

Reference	Designation
Da	Automatic drain connection
Dm	Manual drain connection

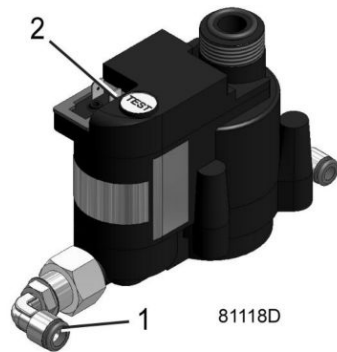

Electronic water drain (ED), typical example

Test the electronic water drain. Press the test button (2) on top of the device.

2.4 Regulating system

Description

If the air consumption is less than the air output of the compressor, the net pressure increases.

When the net pressure is higher than the set-point (desired net pressure), the regulator decreases the motor speed.

If the net pressure increases and the motor operates at minimum speed, the regulator stops the motor.

When the motor is stopped automatically and the net pressure comes to the set-point, the regulator starts the motor again.

2.5 Electrical system

Electric components

The electrical system has following components:

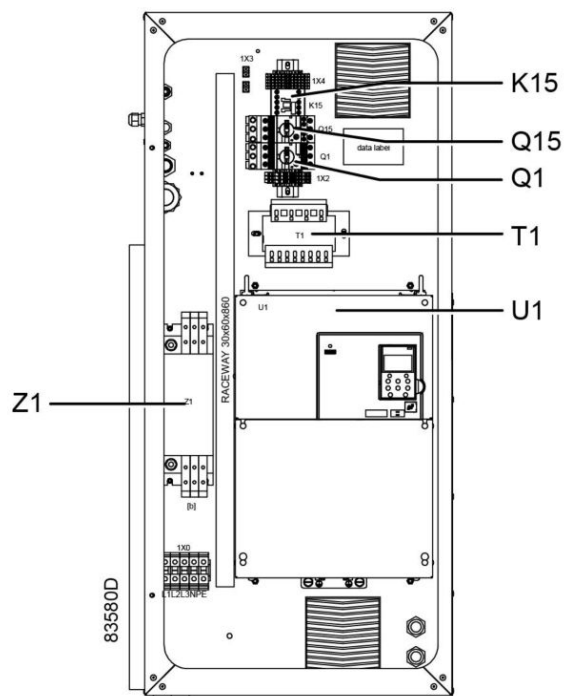

Electric cabinet, typical example

Reference	Designation
T1	Transformer
Q15	Circuit breaker
Q1	Circuit breaker
K15	Contactor
Z1	EMC filter
U1	Frequency converter

Electrical diagrams

You find the complete electrical diagram inside the electric cabinet.

2.6 Air dryer

Flow diagram

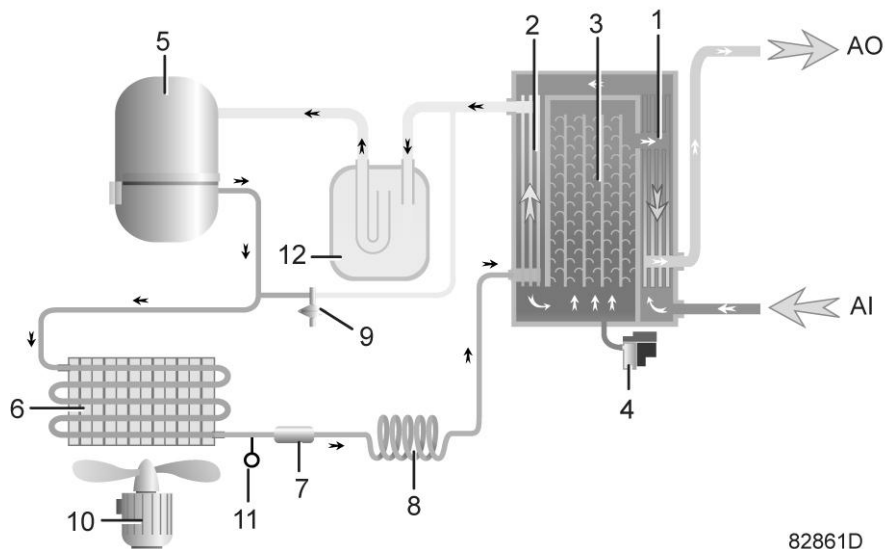

82861D

Air dryer

Reference	Name
AI	Air inlet
AO	Air outlet
1	Air/air heat exchanger
2	Air/refrigerant heat exchanger/evaporator
3	Condensate separator
4	Automatic drain / condensate outlet
5	Refrigerant compressor
6	Refrigerant condenser
7	Liquid refrigerant dryer/filter
8	Capillary
9	Bypass valve
10	Condenser cooling fan
11	Pressure switch, fan control
12	Liquid separator

Compressed air circuit

Compressed air comes in the heat exchanger (1) and the outgoing, cold, dried air cools the incoming compressed air.

Water in air starts to condense. Then, the air flows through the heat exchanger/evaporator (2), where the refrigerant evaporates.

This causes the air to cool further close to the evaporating temperature of the refrigerant. More water in the air condenses.

The cold air flows through the separator (3) where all the condensate gets out of the air.

The condensate is automatically drained through the outlet (4).

The outgoing, cold, dried air flows through the heat exchanger (1) where it is warmed up by the incoming compressed air.

Refrigerant circuit



Refrigeration dryers of ID type contain high efficient refrigerant R410a of the HFC group.

The refrigerant compressor (5) delivers hot, high-pressure refrigerant gas which flows through the refrigerant condenser (6).

Most of the refrigerant condenses.

The liquid refrigerant flows through the liquid refrigerant dryer/filter (7) to the capillary tube (8).

The refrigerant leaves the capillary tube at about evaporating pressure.

The refrigerant enters the evaporator (2) where it gets heat from the compressed air by further evaporation at about constant pressure.

The heated refrigerant leaves the evaporator and gets into the compressor (5) through a liquid separator (12).

A by-pass valve (9) regulates the refrigerant flow.

The fan (10) blows cool air over the refrigerant condenser (6)

The switch (11) sets the fan (10) to on or off, depending on the pressure degree of the condensate.

3 Elektronikon® Graphic controller

3.1 Elektronikon® Graphic controller

Control panel

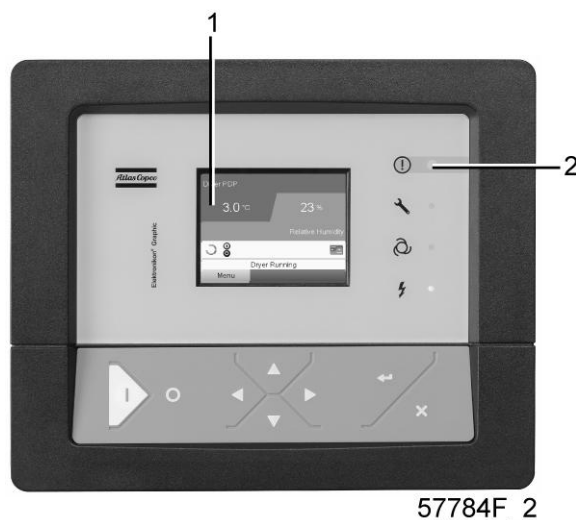

Display of the Elektronikon® Graphic controller

Introduction

The Elektronikon® controller has following functions:

- Controlling the compressor
- Protecting the compressor
- Monitoring components subject to service
- Automatic restart after voltage failure (made inactive)

Automatic control of the compressor operation

The controller maintains the net pressure within programmable limits by automatically adapting the motor speed. A number of programmable settings, e.g. the setpoint, the minimum stop time and the maximum number of motor starts and several other parameters are hereby taken into account.

The controller stops the compressor whenever possible to reduce the power consumption and restarts it automatically when the net pressure decreases. In case of risk for condensate forming in the oil, the compressor activates the condensate prevention cycle and keeps running for a specified time.



A number of time based automatic start/stop commands may be programmed. Take into account that a start command will be executed (if programmed and activated), even after manually stopping the compressor.

Protecting the compressor

Shut-down

Several sensors are provided on the compressor. If one of the measured signals exceeds the programmed shut-down level, the compressor will be stopped. This will be indicated on display (1) and general alarm LED (2) will blink.

Remedy the trouble and reset the message. See also the [Inputs menu](#).

	Before remedying, consult the applicable safety precautions.
---	--

Shut-down warning

A shut-down warning level is a programmable level below the shut-down level.

If one of the measured signals exceeds the programmed shut-down warning level, a message will appear on display (1) and general alarm LED (2) will light up to warn the operator that the shut-down warning level is exceeded.

The message disappears as soon as the warning condition disappears.

Warning

A warning message will appear if, on Full-Feature compressors, the dew point temperature is too high in relation to the ambient temperature.

Service warning

A number of service operations are grouped (called Service Plans). Each Service Plan has a programmed time interval. If a time interval is exceeded, a message will appear on display (1) to warn the operator to carry out the service actions belonging to that Service Plan.

Automatic restart after voltage failure

The controller has a built-in function to automatically restart the compressor when the voltage is restored after voltage failure. For compressors leaving the factory, this function is made inactive. If desired, the function can be activated. Consult the Atlas Copco Customer Centre.

	If the function is activated and provided the regulator was in the automatic operation mode, the compressor will automatically restart if the supply voltage to the module is restored.
---	---

3.2 Control panel

Elektronikon regulator

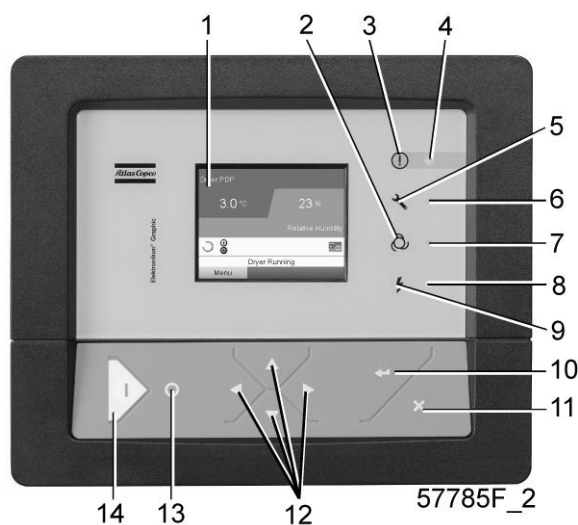











Control panel







Parts and functions

Reference	Designation	Function
1	Display	Shows the compressor operating condition and a number of icons to navigate through the menu.
2	Pictograph	Automatic operation
3	Pictograph	General alarm
4	Alarm LED	Flashes in case of a shut-down, is lit in case of a warning condition.
5	Pictograph	Service
6	Service LED	Lights up if service is needed
7	Automatic operation LED	Indicates that the regulator is automatically controlling the compressor.
8	Voltage on LED	Indicates that the voltage is switched on.
9	Pictograph	Voltage
10	Enter key	Use this button to confirm the last action.
11	Escape key	Use this button to go to previous screen or to end the current action.
12	Scroll keys	Keys to scroll through the menu.
13	Stop button	Button to stop the compressor. LED (7) goes out.
14	Start button	Button to start the compressor. LED (7) lights up indicating that the Elektronikon regulator is operative.



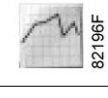

3.3 Icons used

Status icons



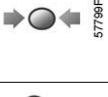







Name	Icon	Description
Stopped / Running	 57786F	When the compressor is stopped, the icon stands still. When the compressor is running, the icon is rotating.
Compressor status	 57787F	Motor stopped
	 57788F	Running unloaded
	 57789F	Running loaded
Machine control mode	 57790F or  59161F	Local start / stop
	 57791F	Remote start / stop
	 57792F	Network control
	 57793F	Automatic restart after voltage failure is active
Week timer	 57794F	Week timer is active

Name	Icon	Description
Active protection functions	 57795F	Emergency stop
	 57796F	Shutdown
	 57797F	Warning
Service	 57798F	Service required
Main screen display	 59162F	Value lines display icon
	 82196F	Chart display icon
General icons	 81105D	No communication / network problem
	 82418D	Not valid

Input icons







Icon	Description
 57799F	Pressure
 57800F	Temperature
 57801F	Digital input
 57802F	Special protection

System icons



Icon	Description
 57803F	Compressor element (LP, HP, ...)
 57804F	Dryer
 57805F	Fan
 57806F	Frequency converter
 57807F	Drain
 57808F	Filter
 57809F	Motor
 57810F	Failure expansion module
 81105D	Network problem
 57812F	General alarm

Menu icons

Icon	Description
 57813F	Inputs
 57814F	Outputs
 57812F	Alarms (Warnings, shutdowns)
 57815F	Counters
 57816F or  82641D	Test

Icon	Description
 57817F	Settings
 57798F	Service
 57818F	Event history (saved data)
 57819F	Access key / User password
 57792F	Network
 57820F	Setpoint
 57867F	Info

Navigation arrows

Icon	Description
 57821F	Up
 57822F	Down

3.4 Main screen

Control panel

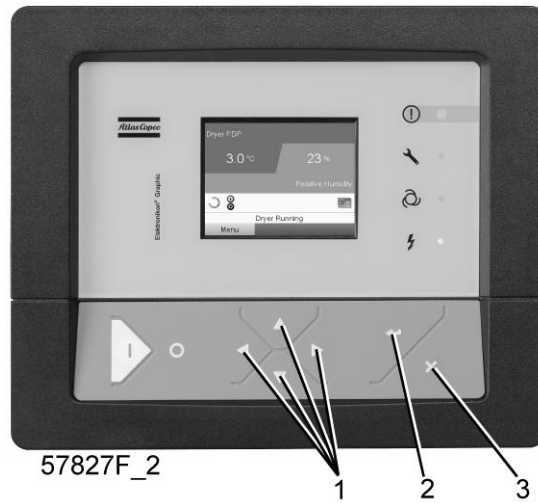

(1)	Scroll keys
(2)	Enter key
(3)	Escape key

Function

The Main screen is the screen that is shown automatically when the voltage is switched on and one of the keys is pushed. It is switched off automatically after a few minutes when no keys are pushed.

Typically, 5 different main screen views can be chosen:

1. Two value lines
2. Four value lines
3. Chart (High resolution)
4. Chart (Medium resolution)
5. Chart (Low resolution)

Two and four value lines screens

This type of Main screen shows the value of 2 or 4 parameters (see section [Inputs menu](#)).

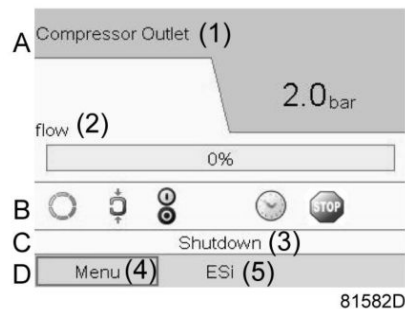

Typical Main screen (2 value lines)

Text on figures

(1)	Compressor Outlet
(2)	Flow
(3)	Load, shutdown, ... (text varies upon the compressors actual condition)
(4)	Menu
(5)	Unload, ES,...(text varies upon the compressors actual condition)

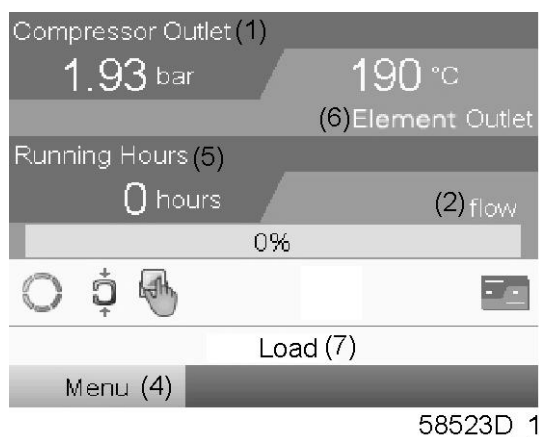

Typical Main screen (4 value lines)

Text on figures

(1)	Compressor Outlet
(2)	Flow
(3)	Off, Shutdown,... (text varies upon the compressors actual condition)
(4)	Menu
(5)	Running hours
(6)	Element outlet
(7)	Load, Unload, ... (text varies upon the compressors actual condition)

- **Section A** shows information regarding the compressor operation (e.g. the outlet pressure or the temperature at the compressor outlet). On compressors with a frequency converter, the load degree (flow) is given in % of the maximum flow.
- **Section B** shows Status icons. Following icon types are shown in this field:
 - Fixed icons
These icons are always shown in the main screen and cannot be selected by the cursor (e.g. Compressor stopped or running, Compressor status (running, running unloaded or motor stopped).
 - Optional icons
These icons are only shown if their corresponding function is activated (e.g. week timer, automatic restart after voltage failure , etc.)
 - Pop up icons
These icons pop up if an abnormal condition occurs (warnings, shutdowns, service,...)

To call up more information about the icons shown, select the icon concerned using the scroll keys and press the enter key.
- **Section C** is called the Status bar
This bar shows the text that corresponds to the selected icon.

- **Section D** shows the Action buttons. These buttons are used:
 - To call up or program settings
 - To reset a motor overload, service message or emergency stop
 - To have access to all data collected by the regulator

The function of the buttons depends on the displayed menu. The most common functions are:

Designation	Function
Menu	To go to the menu
Modify	To modify programmable settings
Reset	To reset a timer or message

To activate an action button, highlight the button by using the Scroll keys and press the Enter key. To go back to the previous menu, press the Escape key.

Chart views

Instead of viewing values, it is also possible to view a graph of one of the input signals (see section [Inputs menu](#)) in function of the time.



59166D

When Chart (High Resolution) is selected, the chart shows the variation of the selected input (in this case the pressure) per minute. Also the instantaneous value is displayed. The screen shows the last 4 minutes.

The switch button (icon) for selecting other screens is changed into a small Chart and is highlighted (active).

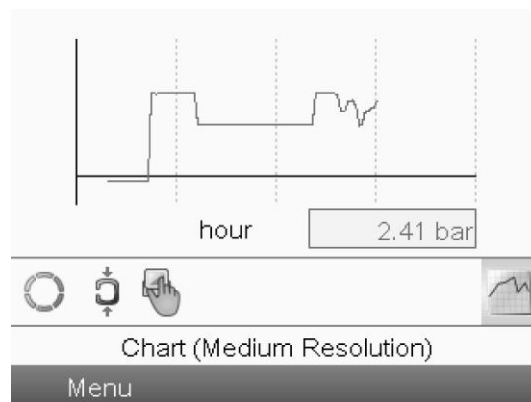

59167D

When the Chart (Medium Resolution) is selected, the chart shows the variation of the selected input per hour. The screen shows the last 4 hours.



59168D

When the Chart (Low Resolution) is selected, the chart shows the variation of the selected input per day. The screen shows the evolution over the last 10 days.

Selection of a main screen view

To change between the different screen layouts, select the far right icon in the control icons line (see value lines display icon or chart display icon in section [Icons used](#)) and press the Enter key. A screen similar to the one below opens:

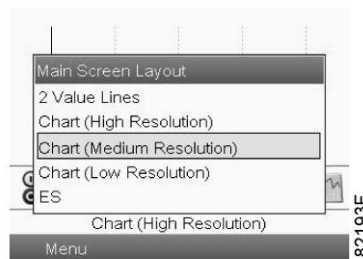

82193F

Select the layout required and press the Enter key. See also section [Inputs menu](#).

3.5 Calling up menus

Control panel

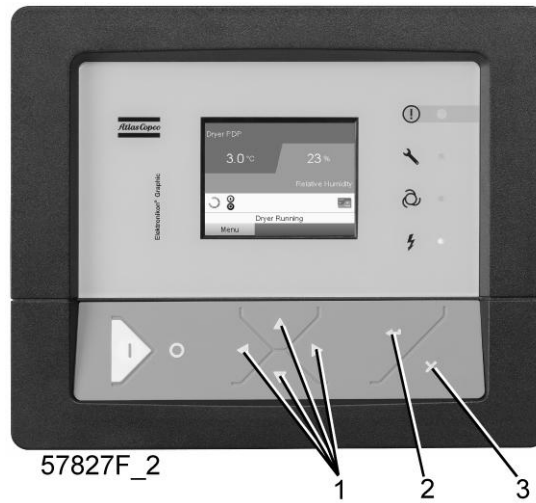

57827F_2

Control panel

(1)	Scroll keys
(2)	Enter key
(3)	Escape key

Description

When the voltage is switched on, the main screen is shown automatically (see section [Main screen](#)):

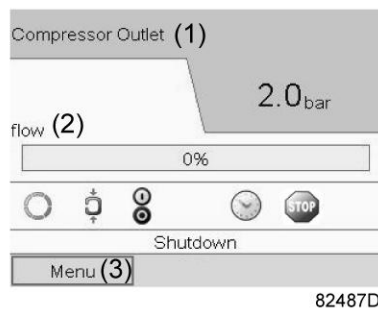

Typical Main screen (2 value lines)

- To go to the Menu screen, select <Menu> (3), using the Scroll keys.
- Press the Enter key to select the menu. Following screen appears:

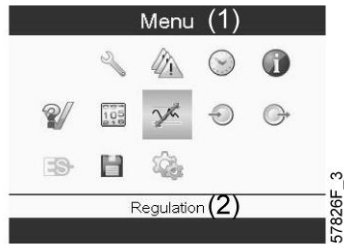

- The screen shows a number of icons. Each icon indicates a menu item. By default, the Pressure Settings (Regulation) icon is selected. The status bar shows the name of the menu that corresponds with the selected icon.
- Use the Scroll keys to select an icon.
- Press the Escape key to return to the Main screen.

3.6 Inputs menu

Control panel

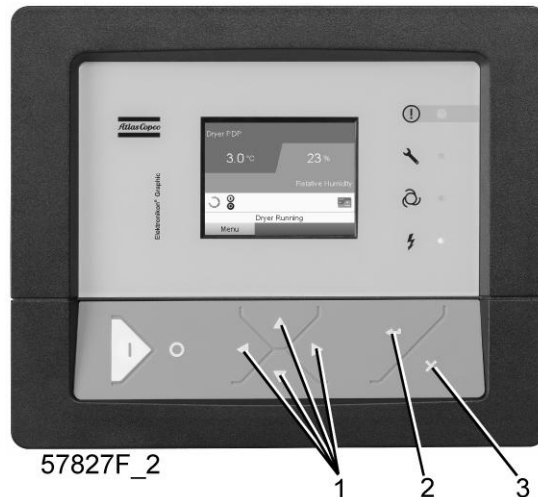

(1)	Scroll keys
(2)	Enter key
(3)	Escape key

Menu icon, Inputs



Function

- To display the actual value of the measured data (analog inputs) and the status of the digital inputs (e.g. emergency stop contact, motor overload relay, etc.).
- To select the digital input to be shown on the chart in the main screen.

Procedure

Starting from the main screen,

- Move the cursor to the action button Menu and press the Enter key. Following screen appears:

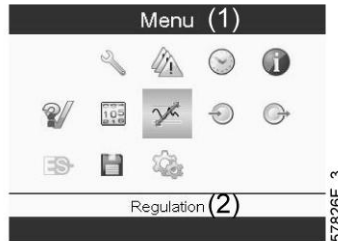

Text on image

(1)	Menu
(2)	Regulation

- Using the Scroll keys, move the cursor to the Inputs icon (see above, section Menu icon).
- Press the Enter key. A screen similar to the one below appears:

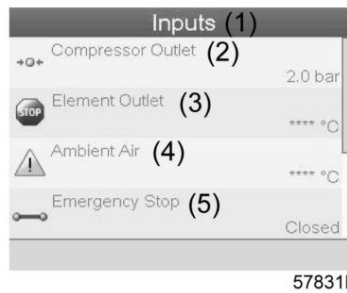

Text on image

(1)	Inputs
(2)	Compressor outlet
(3)	Element outlet
(4)	Ambient air
(5)	Emergency stop

- The screen shows a list of all inputs with their corresponding icons and readings.
- If an input is in warning or shutdown, the original icon is replaced by the warning or shutdown icon respectively (i.e. the Stop icon and the Warning icon in the screen shown above).

A small chart icon, shown below an item in the list means this input signal is shown on the chart at the main screen. Any analog input can be selected.

Selecting another input signal as main chart signal

With the Modify button active (light grey background in above screen), press the Enter button on the controller. A screen similar to the one below appears:



The first item in the list is highlighted. In this example, the Net Pressure is selected (chart icon). To change, press the Enter button again: a pop-up window opens:



Press Enter again to remove this input from the chart. Another confirmation pop-up opens:

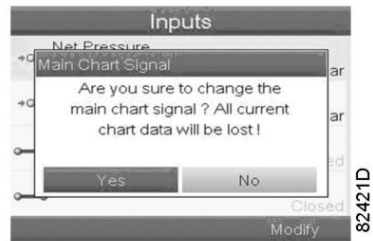

Select Yes to remove or No to quit the current action.

In a similar way, another input signal can be highlighted and selected as Main Chart signal:

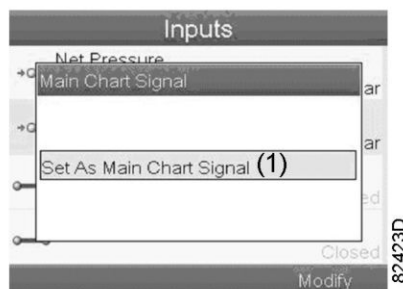

(1): Set as main chart signal

3.7 Outputs menu

Control panel

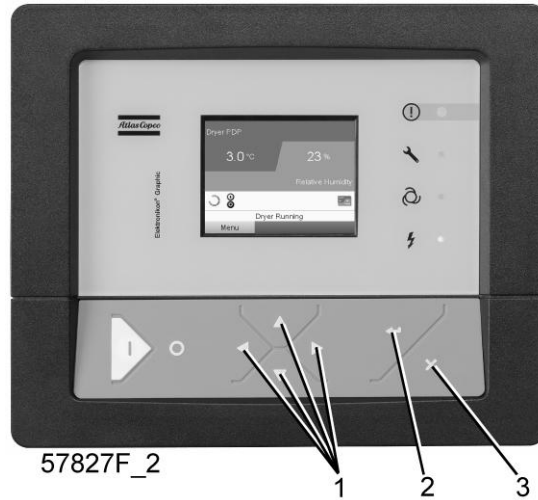

(1)	Scroll keys
(2)	Enter key
(3)	Escape key

Menu icon, Outputs



Function

To call up information regarding the actual status of some outputs such as the condition of the Fan overload contact (on air cooled compressors), the Emergency stop contact, etc.

Procedure

Starting from the Main screen,

- Move the cursor to the action button Menu and press the Enter key. Following screen appears:

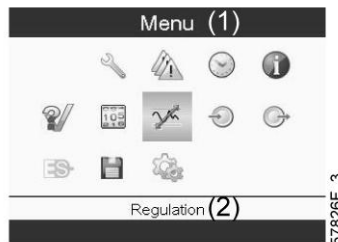

Text on figure

(1)	Menu
(2)	Regulation

- Move the cursor to the Outputs icon (see above, section Menu icon, using the Scroll keys).
- Press the Enter key. A screen similar to the one below appears:

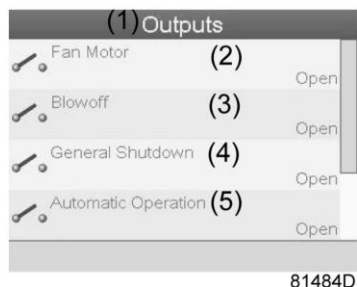

Outputs screen (typical)

Text on image

(1)	Outputs
(2)	Fan motor contact
(3)	Blow-off contact
(4)	General shutdown
(5)	Automatic operation

- The screen shows a list of all outputs with their corresponding icons and readings. If an output is in warning or shutdown, the original icon is replaced by the warning or shutdown icon respectively.

3.8 Counters

Control panel

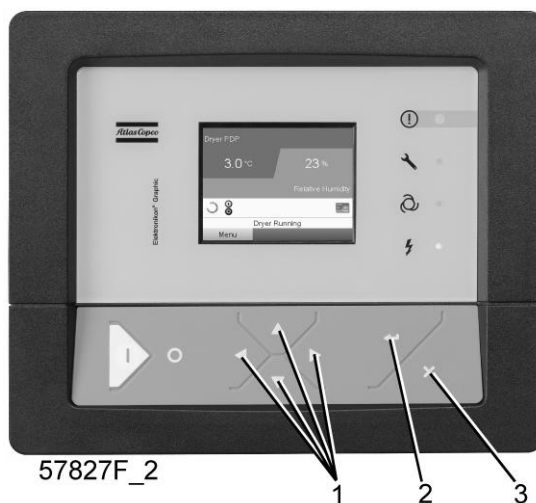

(1)	Scroll keys
(2)	Enter key
(3)	Escape key

Menu icon, Counters



Function

To call up:

- The running hours
- The loaded hours
- The number of motor starts
- The number of hours that the regulator has been powered
- The number of load cycles
- The number of recirculation cycles
- The number of recirculation cycle failures

Procedure

Starting from the Main screen (see [Main screen](#)),

- Move the cursor to the action button Menu and press the Enter key. Following screen appears:

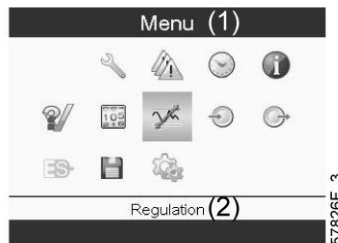

Text on figure

(1)	Menu
(2)	Regulation

- Using the Scroll keys, move the cursor to the Counters icon (see above, section Menu icon)
- Press the Enter key. Following screen appears:

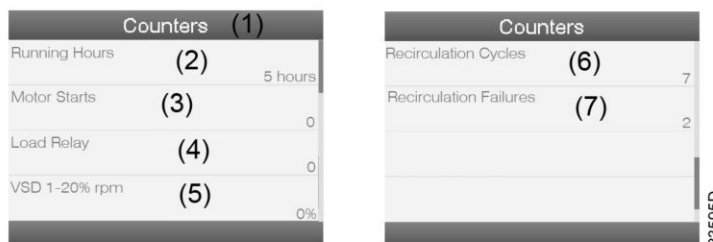

Text on figure

(1)	Counters
(2)	Running Hours
(3)	Motor Starts
(4)	Load Relay
(5)	VSD 1-20 % rpm in % (the percentage of the time during which the motor speed was between 1 and 20 %)
(6)	Recirculation Cycles
(7)	Recirculation Failures

The screen shows a list of all counters with their actual readings.

3.9 Control mode selection

Control panel

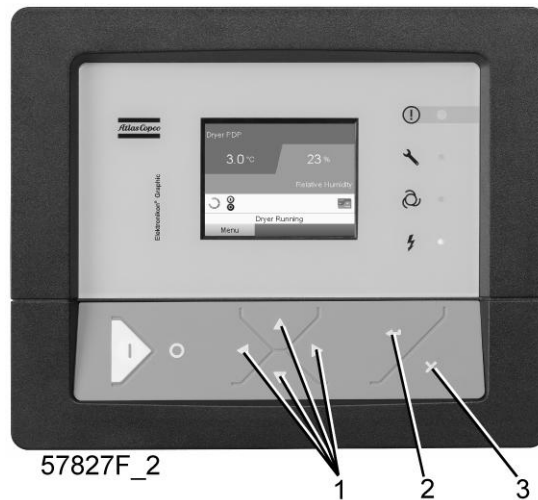

(1)	Scroll keys
(2)	Enter key
(3)	Escape key

Function

To select the control mode, i.e. whether the compressor is in local control, remote control or controlled via a local area network (LAN).

Procedure

Starting from the main screen, make sure the button Menu (1) is selected:

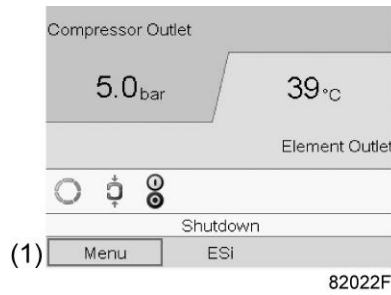

Next, use the scroll buttons to go to the regulation icon (2) and press the enter button:

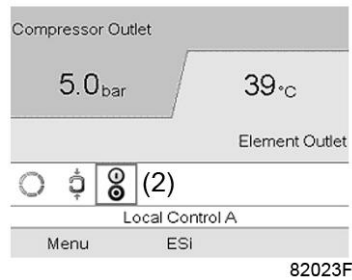

There are 3 possibilities:

- Local control
- Remote control
- LAN (network) control

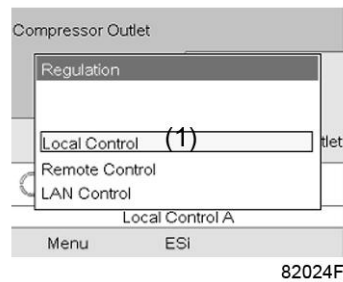

After selecting the required regulation mode, press the enter button on the controller to confirm your selection. The new setting is now visible on the main screen. See section [Icons used](#) for the meaning of the icons.

3.10 Service menu

Control panel

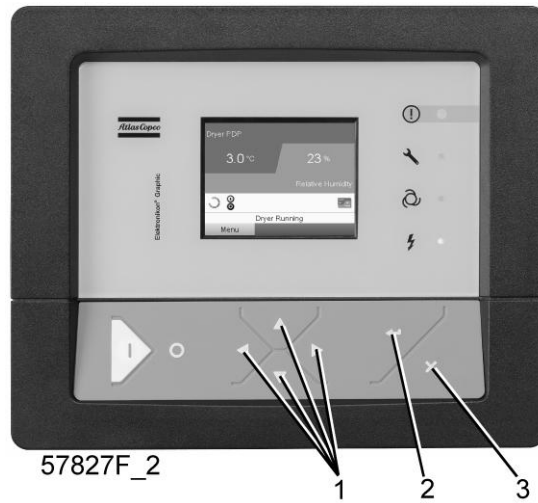

(1)	Scroll keys
(2)	Enter key
(3)	Escape key

Menu icon, Service



Function

- To reset the service plans which are carried out.
- To check when the next service plans are to be carried out.
- To find out which service plans were carried out in the past.
- To modify the programmed service intervals.

Procedure

Starting from the Main screen,

- Move the cursor to the action button Menu and press the Enter key. Following screen appears:

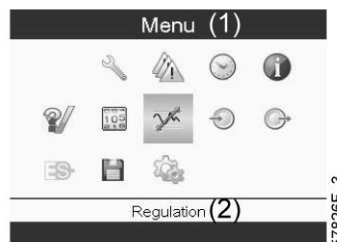

- Using the Scroll keys, move the cursor to the Service icon (see above, section Menu icon).

- Press the Enter key. Following screen appears:

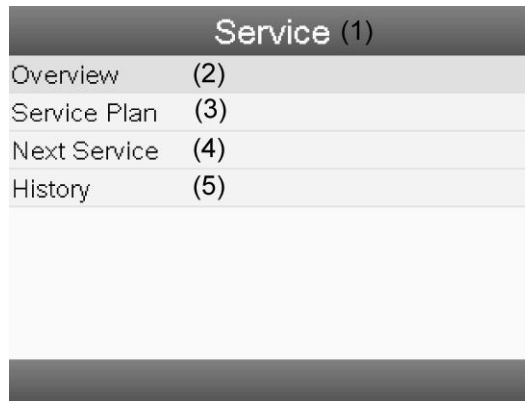

57847F_1

Text on image

(1)	Service
(2)	Overview
(3)	Service plan
(4)	Next service
(5)	History

- Scroll through the items to select the desired item and press the Enter key to see the details as explained below.

Overview



57848F

Text on image

(1)	Overview
(2)	Running Hours
(3)	Real Time hours
(4)	Reset

Example for service level (A):

The figures at the left are the programmed service intervals. For Service interval A, the programmed number of running hours is 4000 hours (upper row) and the programmed number of real time hours is 8760 hours, which corresponds to one year (second row). This means that the controller will launch a service warning when either 4000 running hours or 8760 real hours are reached, whichever comes first. Note that the real time hours counter keeps counting, also when the controller is not powered.

The figures within the bars are the number of hours to go till the next service intervention. In the example above, the compressor was just started up, which means it still has 4000 running hours or 8280 hours to go before the next Service intervention.

Service plans

A number of service operations are grouped (called Level A, Level B, etc...). Each level stands for a number of service actions to be carried out at the time intervals programmed in the Elektronikon® controller.

When a service plan interval is reached, a message will appear on the screen.

After carrying out the service actions related to the indicated levels, the timers must be reset.

From the Service menu above, select Service plan (3) and press Enter. Following screen appears:

Service Plan (1)		
(2) Level	(3) Running Hours	(4) Real Time
A	4000	8760
B	8000	17520
C		
D	24000	
E	32000	
		(5) Modify

57849F

Text on image

(1)	Service plan
(2)	Level
(3)	Running hours
(4)	Real time hours
(5)	Modify

Modifying a service plan

Dependant on the operating conditions, it can be necessary to modify the service intervals. To do so, use the Scroll keys to select the value to be modified. A screen similar to the one below appears:

Service Plan (1)		
(2) Level	(3) Running Hours	(4) Real Time
A	4000	8760
B	8000	17520
C		
D	24000	
E	32000	
		(5) Modify

57850F

Press the Enter key. Following screen appears:

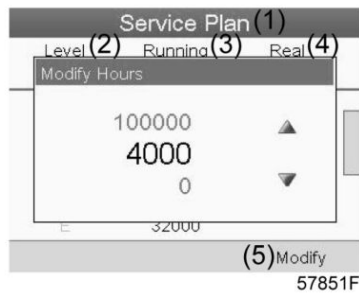

Modify the value as required using the ↑ or ↓ scroll key and press the Enter key to confirm.

Note: Running hours can be modified in steps of 100 hours, real time hours can be modified in steps of 1 hour.

Next Service

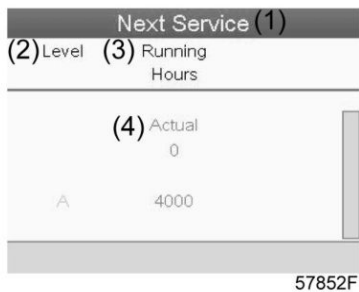

Text on image

(1)	Next service
(2)	Level
(3)	Running hours
(4)	Actual

In the example above, the A Service level is programmed at 4000 running hours, of which 0 hours have passed.

History

The History screen shows a list of all service actions done in the past, sorted by date. The date at the top is the most recent service action. To see the details of a completed service action (e.g. Service level, Running hours or Real time hours), use the Scroll keys to select the desired action and press the Enter key.

3.11 Modifying the setpoint

Control panel

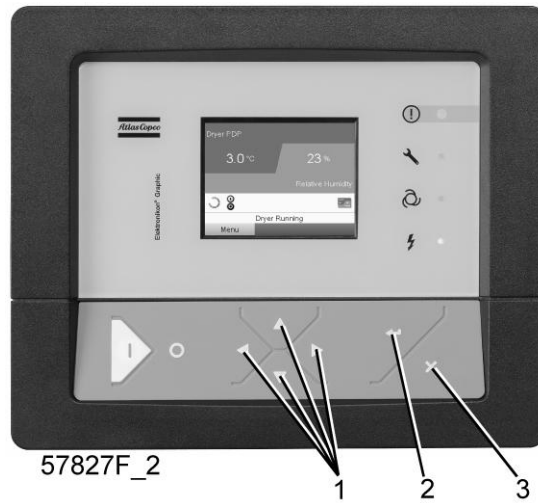

(1)	Scroll keys
(2)	Enter key
(3)	Escape key

Menu icon, Setpoint



Function

On compressors with a frequency converter driven main motor, it is possible to program two different setpoints. This menu is also used to select the active setpoint.

Procedure

Starting from the Main screen,

- Highlight the action key Menu using the Scroll keys and press the Enter key. Following screen appears:

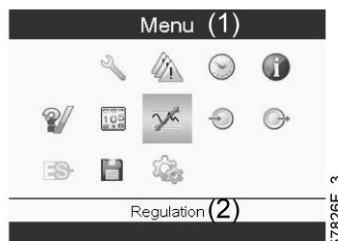

Text on image

(1)	Menu
(2)	Regulation

- Activate the menu by pressing the enter key. A screen similar to the one below appears:



Text on image

(1)	Regulation
(2)	Setpoint 1
(3)	Indirect stop level 1
(4)	Direct stop level 1
(5)	Setpoint 2
(6)	Modify

- The screen shows the actual settings. To modify the settings, move the cursor to the action button Modify and press the Enter key. Following screen appears:



- The first line of the screen is highlighted. Use the Scroll keys (1) to highlight the setting to be modified and press the Enter key (2). Following screen appears:

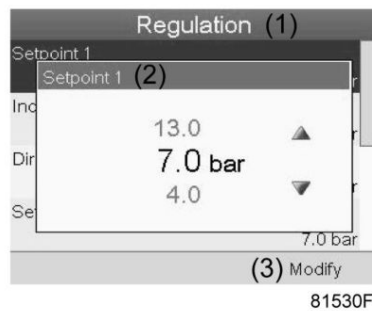

The upper and lower limit of the setting is shown in grey, the actual setting is shown in black. Use the ↑ or ↓ key of the Scroll keys to modify the settings as required and press the Enter key to accept.

If necessary, change the other settings as required in the same way as described above.

Indirect stop: occurs when the pressure rises to the pre-set Indirect stop setpoint (= setpoint plus Indirect stop level). The motor will decelerate to minimum speed and the compressor will switch to unloaded condition.

Direct stop: occurs when the compressor runs at a speed between minimum and maximum and the net pressure rises above the direct stop setpoint (= setpoint plus Direct stop level).

Both settings (Indirect stop level and Direct stop level) are programmable, see section Programmable settings.

3.12 Event history menu

Control panel

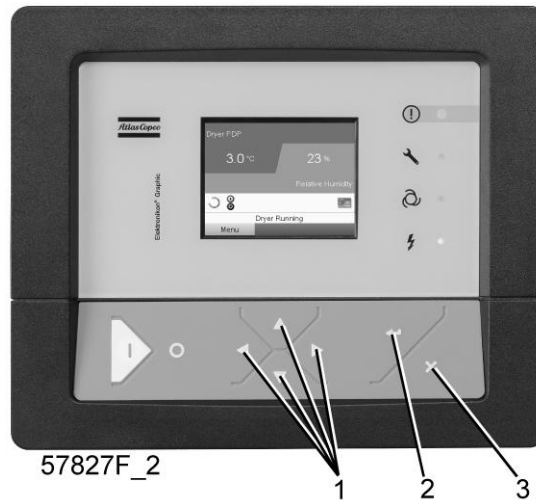

(1)	Scroll keys
(2)	Enter key
(3)	Escape key

Menu icon, Event History



Function

To call up the last shut-down and last emergency stop data.

Procedure

Starting from the Main screen,

- Move the cursor to the action button Menu and press the Enter key. Following screen appears:

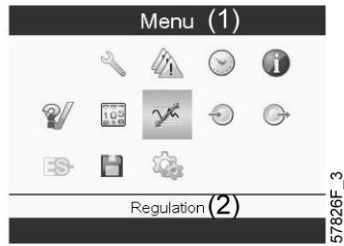

- Using the Scroll keys, move the cursor to the Event History icon (see above, section Menu icon)
- The list of last shut-down and emergency stop cases is shown.



Example of Event History screen

- Scroll through the items to select the desired shut-down or emergency stop event.
- Press the Enter key to find the date, time and other data reflecting the status of the compressor when that shut-down or emergency stop occurred.

3.13 Modifying general settings

Control panel

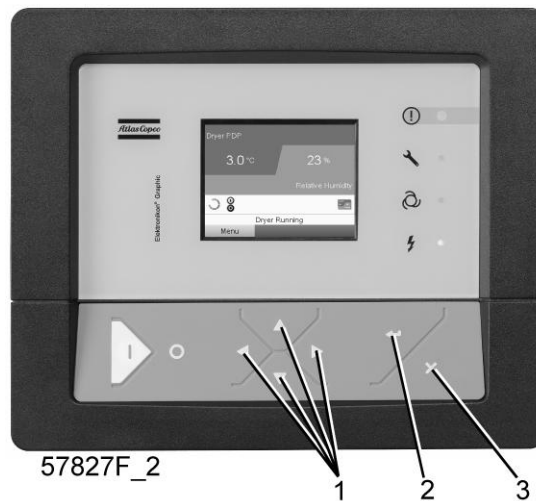

(1)	Scroll keys
(2)	Enter key
(3)	Escape key

Menu icon, Settings



Function

To display and modify a number of settings.

Procedure

Starting from the Main screen,

- Move the cursor to the action button Menu and press the Enter key. Following screen appears:

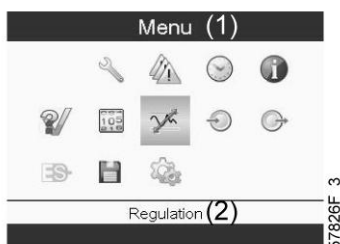

- Next, move the cursor to the Settings icon (see above, section menu icon).using the Scroll keys.
- Press the Enter key. Following screen appears:

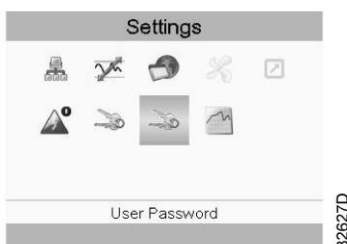

This screen shows again a number of icons. By default, the User Password icon is selected. The status bar shows the description that corresponds with the selected icon. Each icon covers one or more items , such as

- Access level
- Elements
- Dryer
- Fan
- Converter(s)
- Filter(s)
- Motor/Starter
- General
- Automatic restart after voltage failure (ARAF)
- Network
- Regulation
- Remote

For adapting certain parameters, a password may be necessary.

Example: Selecting the General Settings icon gives the possibility to change e.g. the language, the date, the date format, etc.:

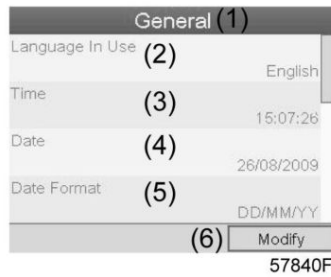

Text on image

(1)	General
(2)	Language used
(3)	Time
(4)	Date
(5)	Date format
(6)	Modify

- To modify, select the Modify button using the Scroll keys and press the Enter key.
- A screen similar to the one above is shown, the first item (Language) is highlighted. Use the ↓ key of the Scroll keys to select the setting to be modified and press the Enter key.
- A pop-up screen appears. Use the ↑ or ↓ key to select the required value and press the Enter key to confirm.

3.14 Info menu

Control panel

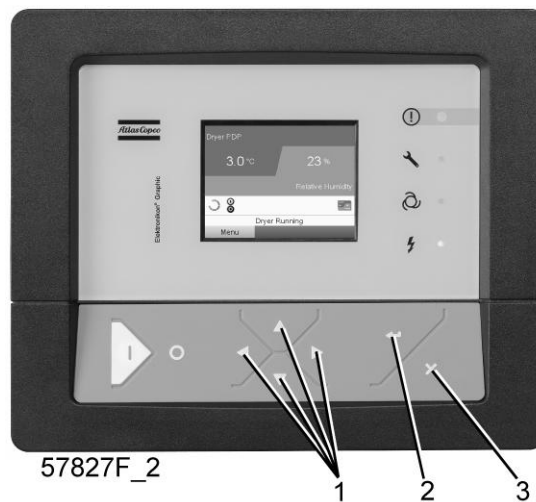

(1)	Scroll keys
(2)	Enter key
(3)	Escape key

Menu icon, Info



Function

To show the Atlas Copco internet address.

Procedure

Starting from the Main screen,

- Move the cursor to the action button Menu and press the Enter key. Following screen appears:

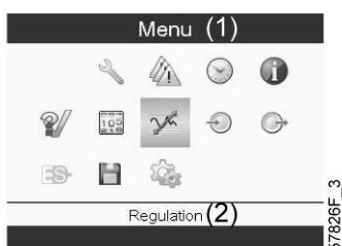

- Using the Scroll keys, move the cursor to the Info icon (see above, section Menu icon).
- Press the Enter key. The Atlas Copco internet address appears on the screen.

3.15 Week timer menu

Control panel

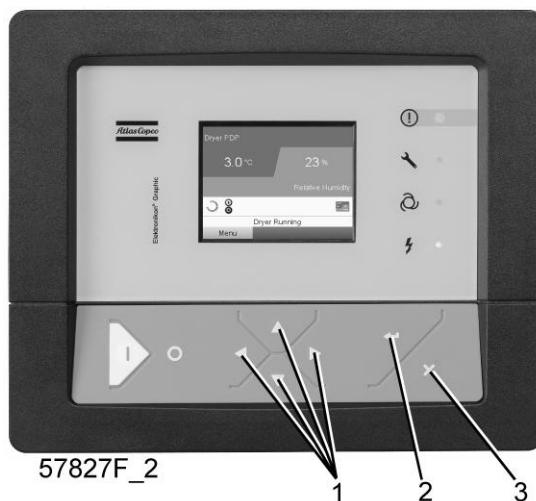

(1)	Scroll keys
(2)	Enter key
(3)	Escape key

Menu icon, Week timer



Function

- To program time-based start/stop commands for the compressor
- To program time-based change-over commands for the net pressure band
- Four different week schemes can be programmed.
- A week cycle can be programmed, a week cycle is a sequence of 10 weeks. For each week in the cycle, one of the four programmed week schemes can be chosen.

	<p>Important remark: In the Elektronikon you can select different timers on one day.(up to 8 actions). It is however not possible to program 2 actions at the same time. The solution: leave at least 1 minute in between 2 actions. Example: Start Compressor: 5.00 AM, Pressure Setpoint 2: 5.01 AM (or later).</p>
--	--

Procedure

Starting from the Main screen (see [Main screen](#)),

- Move the cursor to the action button Menu and press the Enter key. Use the Scroll buttons to select the Timer icon.

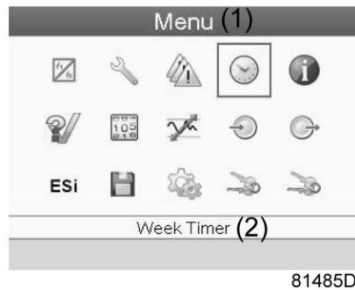

Text on figure

(1)	Menu
(2)	Week Timer

- Press the Enter key on the controller. Following screen appears:



(1)	Week Timer
(2)	Week Action Schemes
(3)	Week Cycle
(4)	Status
(5)	Week Timer Inactive
(6)	Remaining Running Time

The first item in this list is highlighted in red. Select the item requested and press the Enter key on the controller to modify.

Programming week schemes

- Select Week action schemes and press Enter. A new window opens. The first item in the list is highlighted in red. Press the Enter key on the controller to modify Week Action Scheme 1.

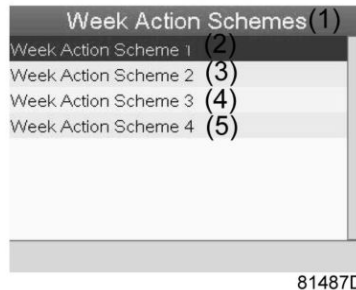

(1)	Week Action Schemes
(2)	Week Action Scheme 1
(3)	Week Action Scheme 2
(4)	Week Action Scheme 3
(5)	Week Action Scheme 4

- A weekly list is shown. Monday is automatically selected and highlighted in red. Press the Enter key on the controller to set an action for this day.

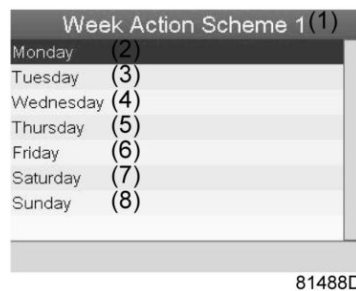

(1)	Week Action Scheme 1
(2)	Monday
(3)	Tuesday
(4)	Wednesday
(5)	Thursday

(6)	Friday
(7)	Saturday
(8)	Sunday

- A new window opens. The Modify action button is selected. Press the enter button on the controller to create an action.

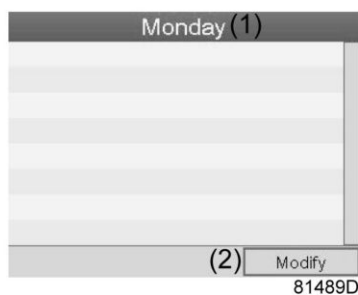

(1)	Monday
(2)	Modify

- A new pop-up window opens. Select an action from this list by using the Scroll keys on the controller. When ready press the Enter key to confirm.

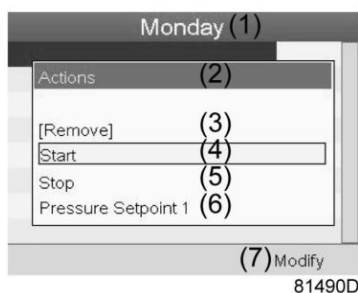

(1)	Monday
(2)	Actions
(3)	Remove
(4)	Start
(5)	Stop
(6)	Pressure Setpoint 1
(7)	Modify

- A new window opens. The action is now visible in the first day of the week.



(1)	Monday
(2)	Start
(3)	Save
(4)	Modify

- To adjust the time, use the Scroll keys on the controller and press the Enter key to confirm.



(1)	Monday
(2)	Start
(3)	Save
(4)	Modify

- A pop-up window opens. Use the ↑ or ↓ key of Scroll keys to modify the values of the hours. Use the ← or → Scroll keys to go to the minutes.

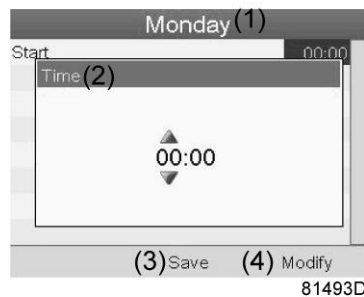

(1)	Monday
(2)	Time
(3)	Save
(4)	Modify

- Press the Escape key on the controller. The action button Modify is selected. Use the Scroll keys to select the action Save.

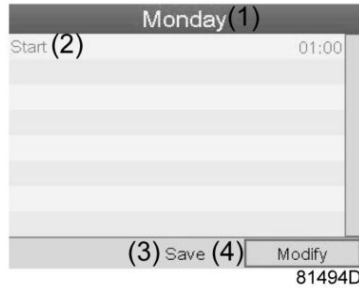

(1)	Monday
(2)	Start
(3)	Save
(4)	Modify

- A new pop-up window opens. Use the Scroll keys on the controller to select the correct actions. Press the Enter key to confirm.

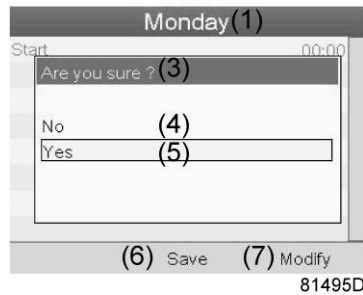

(1)	Monday
(3)	Are you sure?
(4)	No
(5)	Yes
(6)	Save
(7)	Modify

Press the Escape key to leave this window.

- The action is shown below the day the action is planned.

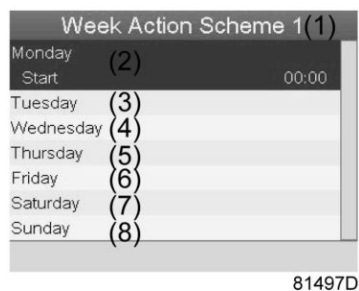

(1)	Week Action Scheme 1
(2)	Monday - Start
(3)	Tuesday
(4)	Wednesday
(5)	Thursday
(6)	Friday
(7)	Saturday
(8)	Sunday

Press the Escape key on the controller to leave this screen.

Programming the week cycle

A week cycle is a sequence of 10 weeks. For each week in the cycle, one of the four programmed week schemes can be chosen.

- Select Week Cycle from the main Week Timer menu list.

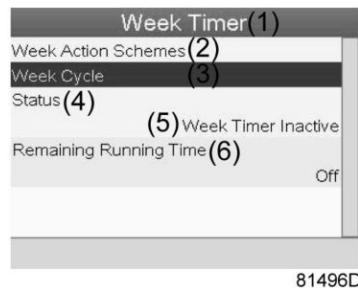

(1)	Week Timer
(2)	Week Action Schemes
(3)	Week Cycle
(4)	Status
(5)	Week Timer Inactive
(6)	Remaining Running Time

- A list of 10 weeks is shown.

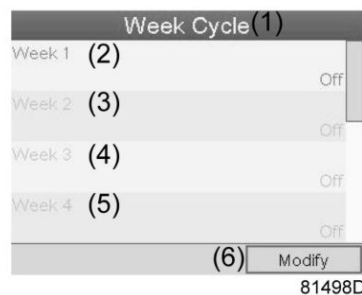

(1)	Week Cycle
(2)	Week 1

(3)	Week 2
(4)	Week 3
(5)	Week 4
(6)	Modify

Press twice the Enter key on the controller to modify the first week.

- A new window opens. Select the action, example: Week Action Scheme 1

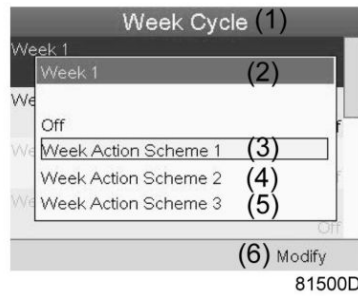

(1)	Week Cycle
(2)	Week 1
(3)	Week Action Scheme 1
(4)	Week Action Scheme 2
(5)	Week Action Scheme 3
(6)	Modify

- Check the status of the Week Timer
Use the Escape key on the controller to go back to the main Week Timer menu. Select the status of the Week Timer.



(1)	Week Timer
(2)	Week Action Schemes
(3)	Week Cycle
(4)	Status
(5)	Week Timer Inactive
(6)	Remaining Running Time

- A new window opens. Select Week 1 to set the Week Timer active.

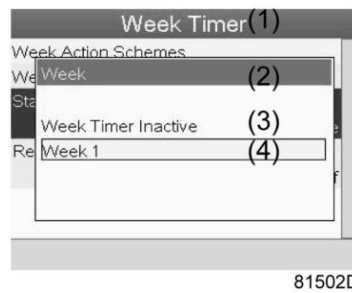

81502D

(1)	Week Timer
(2)	Week
(3)	Week Timer Inactive
(4)	Week 1

- Press the Escape key on the controller to leave this window. The status shows that week 1 is active.



81503D

(1)	Week Timer
(2)	Week Action Schemes
(3)	Week Cycle
(4)	Status
(5)	Remaining Running Time

- Press the Escape key on the controller to go to the main Week Timer menu. Select Remaining Running Time from the list and press the Enter key on the controller to Modify.

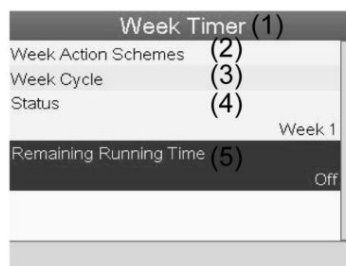

81504D

(1)	Week Timer
(2)	Week Action Schemes
(3)	Week Cycle
(4)	Status
(5)	Remaining Running Time

- This timer is used when the week timer is set and for certain reasons the compressor must continue working, for example, 1 hour, it can be set in this screen. This timer is prior to the Week Timer action.

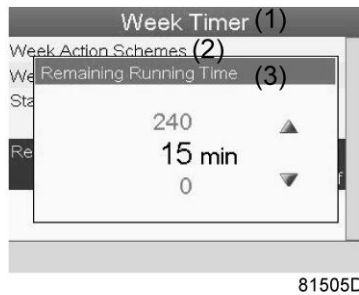

(1)	Week Timer
(2)	Week action schemes
(3)	Remaining Running Time

3.16 Test menu

Control panel

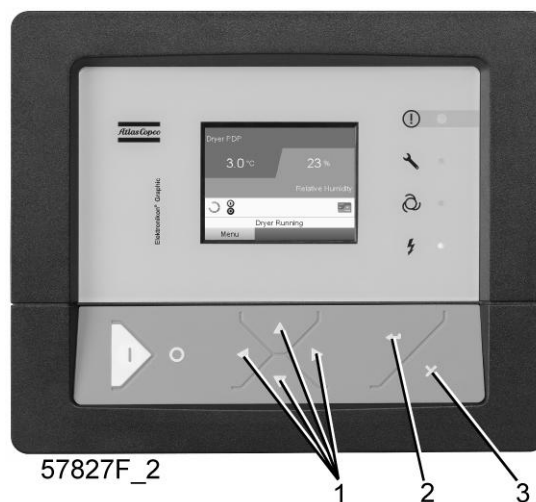

Menu icon, Test



or



82641D

Function

- To carry out a display test, i.e. to check whether the display and LEDs are still intact.

Procedure

Starting from the Main screen,

- Move the cursor to the action button Menu and press the enter key (2), following screen appears:

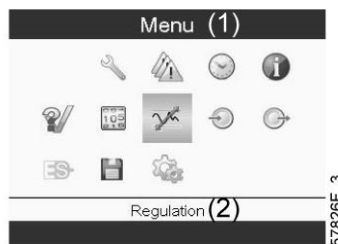

57826F_3

- Using the scroll keys (1), move the cursor to the test icon (see above, section Menu icon)
- Press the enter key (2), following screen appears:

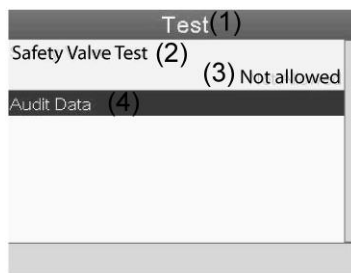

57866F

- The safety valve test can only be performed by authorized personnel and is protected by a security code.
- Select the item display test and press the enter key. A screen is shown to inspect the display, at the same time all LED's are lit.

3.17 User password menu

Control panel

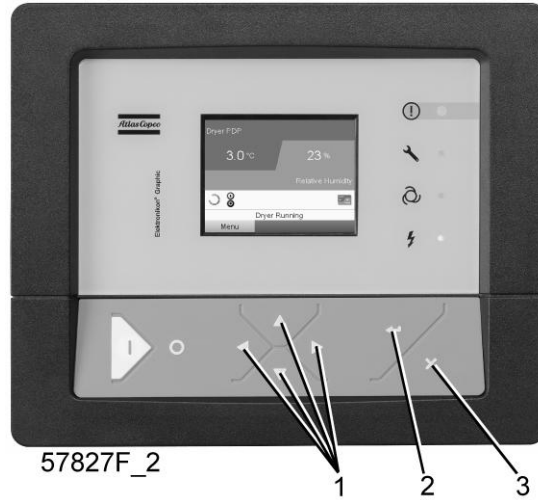

(1)	Scroll keys
(2)	Enter key
(3)	Escape key

Menu icon, Password



Function

If the password option is activated, it is impossible for not authorized persons to modify any setting.

Procedure

Starting from the Main screen (see [Main screen](#)),

- Move the cursor to <Menu> and press the Enter key (2). Following screen appears:

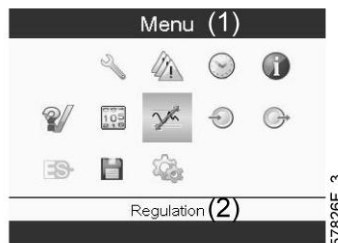

- Using the Scroll keys, select the <Settings> icon (see section [Modifying general settings](#))
- Press the Enter key. Following screen appears:

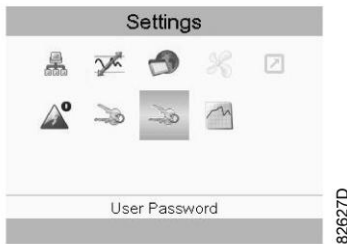

- Move the cursor to the Password icon (see above, section Menu icon)
- Select <Modify> using the Scroll keys and press the Enter key. Next, modify the password as required.

3.18 Web server

All Elektronikon controllers have a built-in web server that allows direct connection to the company network or to a dedicated PC via a local area network (LAN). This allows to consult certain data and settings via a PC instead of via the display of the controller.

Getting started

	<p>If the compressor is equipped with a SMARTBOX, the network connection of the Elektronikon is already in use. To allow the web server functionality, the network cable that is connected to the SMARTBOX should be unplugged and replaced by the cable of the company network.</p> <p>If both the web server functionality and SMARTBOX are required, please contact your Atlas Copco Customer Centre for support.</p>
---	---

Make sure you are logged in as administrator.

- Use the internal network card from your computer or a USB to LAN adapter (see picture below).



USB to LAN adapter

- Use a UTP cable (CAT 5e) to connect to the controller (see picture below).



Configuration of the network card

- Go to My Network places (1).

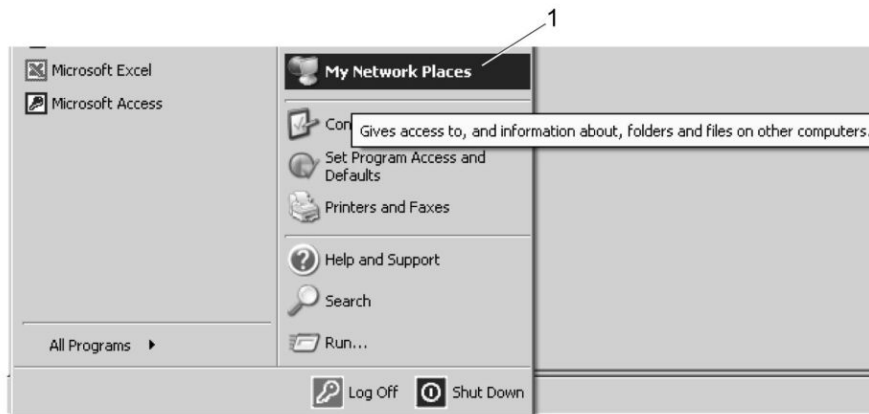

- Click on View Network connections (1).



- Select the Local Area connection (1), which is connected to the controller.

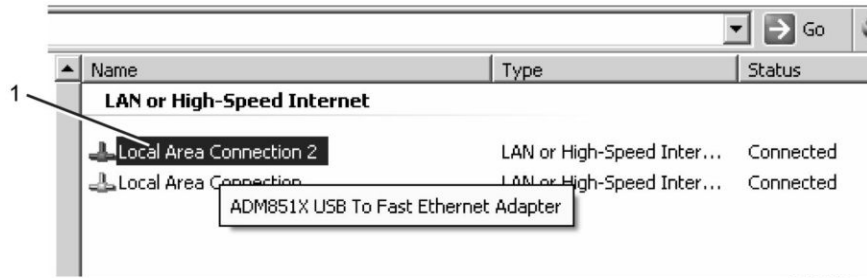

81511D

- Click with the right button and select properties (1).

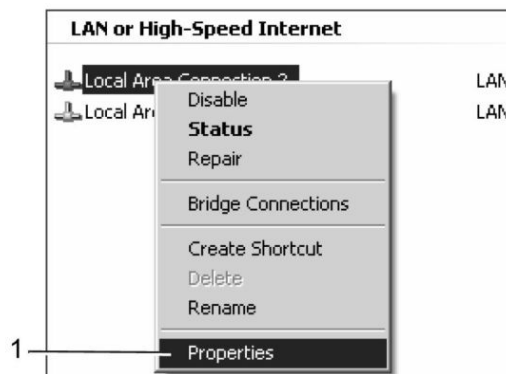

81512D

- Use the check box Internet Protocol (TCP/IP) (1) (see picture). To avoid conflicts, uncheck other properties if they are checked. After selecting TCP/IP, click on the Properties button (2) to change the settings.



81513D

- Use the following settings:
 - IP Address 192.168.100.200
 - Subnetmask 255.255.255.0
 Click OK and close network connections.

Configuration of the web server

Configure the web interface

	<p>The internal web server is designed and tested for Microsoft® Internet Explorer 6, 7 and 8. Other web browsers like Opera and Firefox do not support this internal web server. When using Opera or Firefox, a redirect page opens. Click on the hyperlink to connect to the download server from Microsoft® to download the latest version of Internet Explorer, and install this software.</p>
---	--

- When using Internet Explorer:
Open Internet Explorer and click on Tools - Internet options (2).



- Click on the Connections tab (1) and then click on the LAN settings button (2).

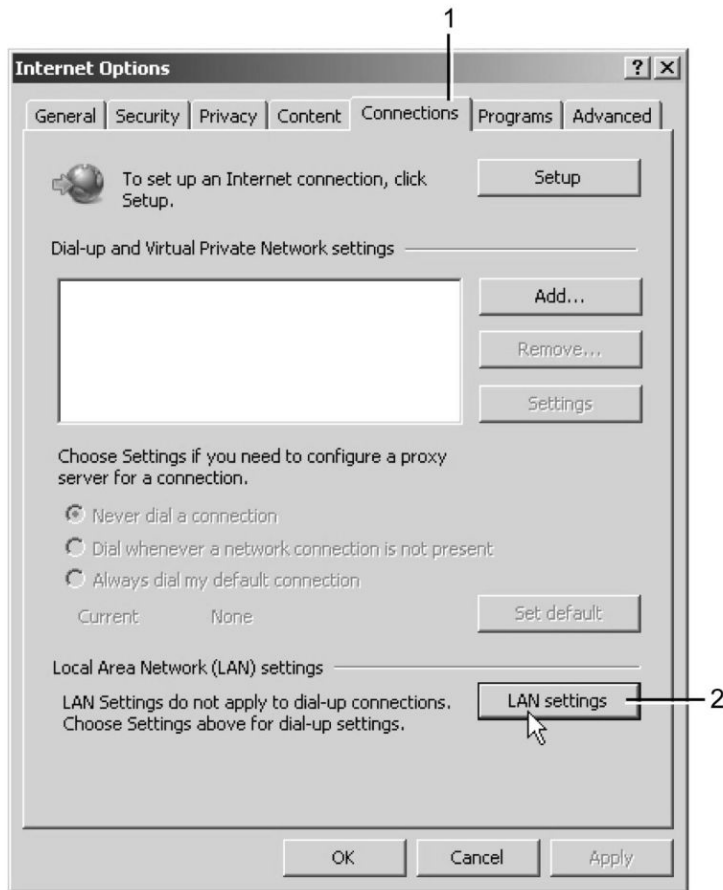

- In the Proxy server Group box, click on the Advanced button (1).

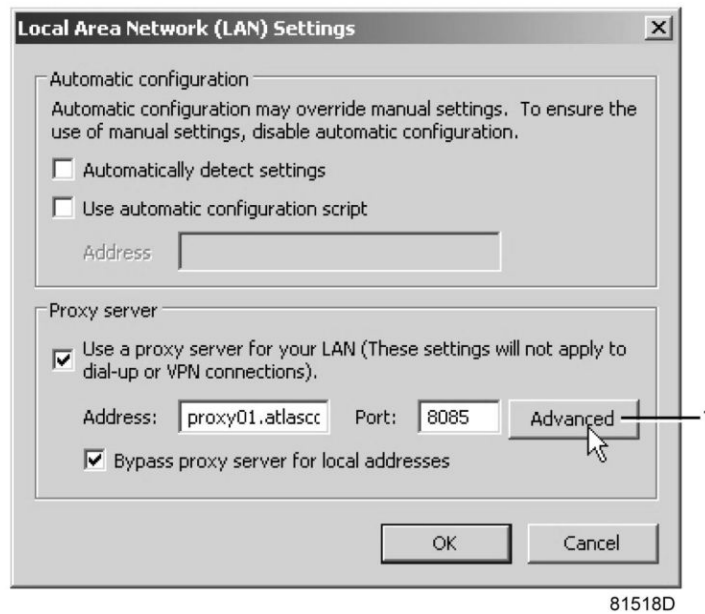

81518D

- In the Exceptions Group box, enter the IP address of your controller. Multiple IP addresses can be given but they must be separated with semicolons (;).
 Example: Suppose that you already added two IP addresses (192.168.100.1 and 192.168.100.2). Now you add 192.168.100.100 and separate the 3 IP addresses by putting semicolons between them (1) (see picture). Click OK (2) to close the window.

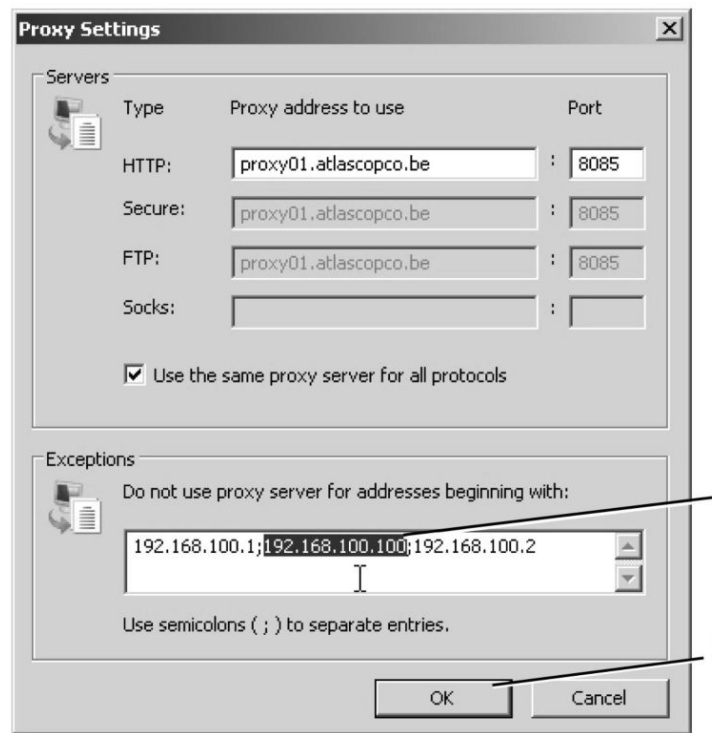

81519D

Viewing the controller data

 All screen shots are indicative. The number of displayed fields depends on the selected options.

- Open your browser and type the IP address of the controller you want to view in your browser (in this example http://192.168.100.100). The interface opens:

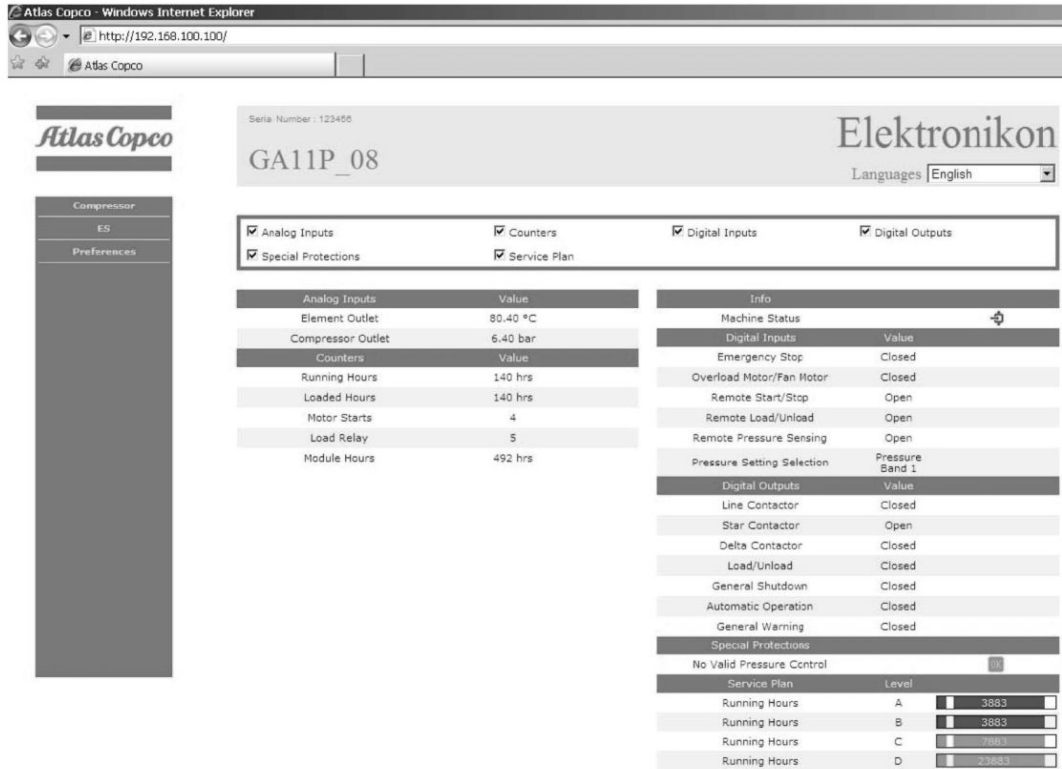

81520D

Navigation and options

- The banner shows the compressor type and the language selector. In this example, three languages are available on the controller.



81521D

- On the left side of the interface you can find the navigation menu (see picture below). If a license for ESi is foreseen, the menu contains 3 buttons.
 - Compressor (or machine): shows all compressor settings.
 - Es: shows the ESi status (if a license is provided).
 - Preferences: allows to change temperature and pressure units.



Compressor settings

All compressor settings can be displayed or hidden. Put a check mark in front of each point of interest and it will be displayed. Only the machine status is fixed and can not be removed from the main screen.

Analog inputs

Lists all current analog input values. The measurement units can be changed in the preference button from the navigation menu.

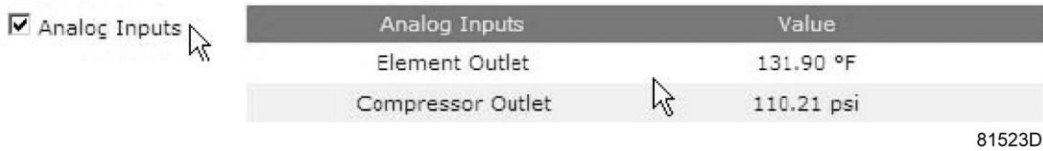

Counters

Lists all current counter values from controller and compressor.



Info status

Machine status is always shown on the web interface.

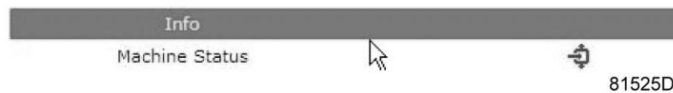

Digital inputs

Lists all Digital inputs and their status.

Digital Inputs

Digital Inputs	Value
Emergency Stop	Closed
Overload Motor/Fan Motor	Closed
Remote Start/Stop	Open
Remote Load/Unload	Open
Remote Pressure Sensing	Open
Pressure Setting Selection	Pressure Band 1

81526D

Digital outputs

Lists all Digital outputs and their status.

Digital Outputs

Digital Outputs	Value
Line Contactor	Closed
Star Contactor	Open
Delta Contactor	Closed
Load/Unload	Closed
General Shutdown	Closed
Automatic Operation	Closed
General Warning	Closed

81527D

Special protections

Lists all special protections of the compressor.



Service plan

Displays all levels of the service plan and their status. This screen shot underneath only shows the running hours. It is also possible to show the current status of the service interval.

Service Plan

Service Plan	Level	Running Hours
Running Hours	A	3971
Running Hours	B	3971
Running Hours	C	7971
Running Hours	D	23971

81529D

ES screen controller

If an ESi license is provided, the ES button is displayed in the navigation menu. At the left all compressors in the ES are shown. At the right the ES status is shown.

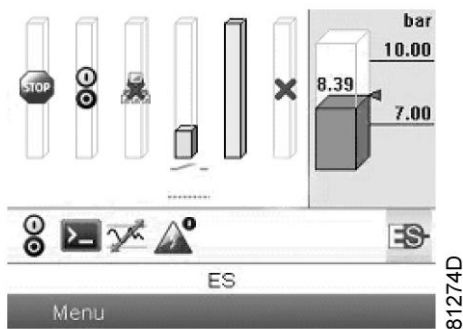

A possible ESi screen

3.19 Programmable settings

Compressor/motor

		Minimum setting	Factory setting	Maximum setting
Set-point 1 and 2, Workplace compressors	bar(e)	4	7	13
Set-point 1 and 2, Workplace compressors	psig	58	100	188
Set-point 1 and 2, Workplace Full-Feature compressors	bar(e)	4	6.8	12.8
Set-point 1 and 2, Workplace Full-Feature compressors	psig	58	99	186
Indirect stop level	bar	0.1	0.3	1
Indirect stop level	psi	1.45	4.35	14.5
Direct stop level	bar	0.3	1	1.5
Direct stop level	psi	4.35	14.5	21.8
Proportional band	%	6	10	15
Integration time	sec	5	6	10

Parameters

		Minimum setting	Factory setting	Maximum setting
Minimum stop time	sec	5	5	30
Power recovery time	sec	10	10	3600
Restart delay	sec	0	0	1200
Communication time-out	sec	10	30	60
Fan motor starts per day (air-cooled compressors)		1	240	240

Protections

		Minimum setting	Factory setting	Maximum setting
Compressor element outlet temperature (shut-down warning level)	°C	50	110	119
Compressor element outlet temperature (shut-down warning level)	°F	122	230	246
Compressor element outlet temperature (shut-down level)	°C	111	120	120
Compressor element outlet temperature (shut-down level)	°F	232	248	248

Specific protections for Full-Feature compressors:

		Minimum setting	Factory setting	Maximum setting
Dewpoint warning temperature	°C	10	25	99
Dewpoint warning temperature	°F	10	77	210

Service plan

The built-in service timers will give a Service warning message after their respective preprogrammed time interval has elapsed.

For specific data, see section Preventive Maintenance.

Consult Atlas Copco if a timer setting needs to be changed. The intervals must not exceed the nominal intervals and must coincide logically. See section [Modifying general settings](#).

Terminology

Term	Explanation
ARAVF	Automatic Restart After Voltage Failure. See section Elektronikon regulator .
Power recovery time	Is the period within which the voltage must be restored to have an automatic restart. Is accessible if the automatic restart is activated. To activate the automatic restart function, consult Atlas Copco.
Restart delay	This parameter allows to programme that not all compressors are restarted at the same time after a power failure (ARAVF active).
Compressor element outlet	The recommended minimum setting is 70 °C (158 °F). For testing the temperature sensor the setting can be decreased to 50 °C (122 °F). Reset the value after testing. The regulator does not accept inconsistent settings, e.g. if the warning level is programmed at 95 °C (203 °F), the minimum limit for the shut-down level changes to 96 °C (204 °F). The recommended difference between the warning level and shut-down level is 10 °C (18 °F).
Delay at signal	Is the time period during which the warning signal must exist before the warning message appears.
Delay at start	Is the time period after starting which must expire before generating a warning. The setting should be less than the setting for the delay at signal.
Minimum stop time	Once the compressor has automatically stopped, it will remain stopped for the minimum stop time, whatever happens with the net air pressure.

Term	Explanation
Proportional band and integration time	The settings for the Proportional band and integration time are determined by experiment. Altering these settings may damage the compressor. Consult Atlas Copco.

4 Installation

4.1 Dimension drawings

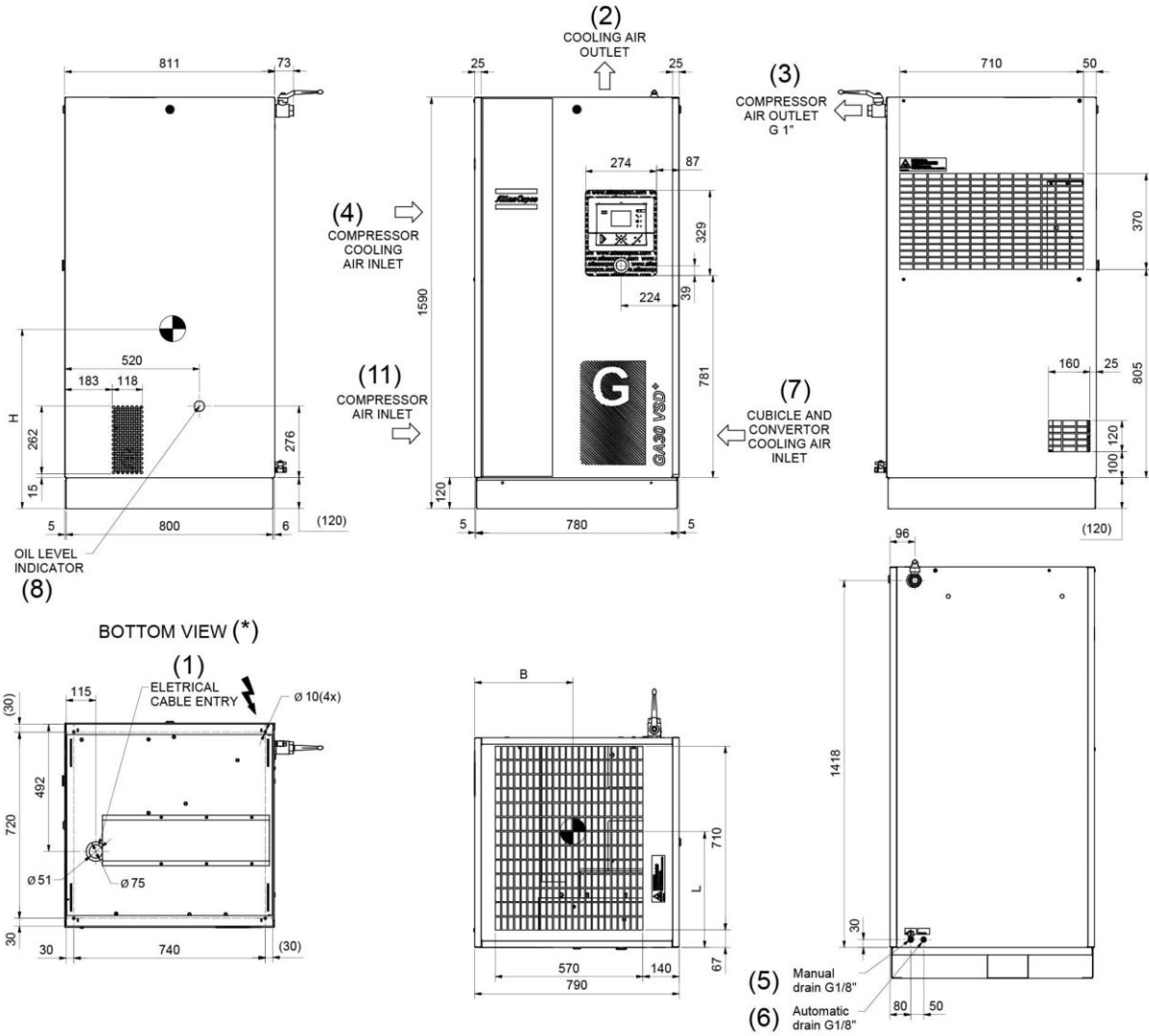

9820 7201 70
83575D

Centre of gravity and weight

Type	L (mm)	B (mm)	H (mm)	Weight (kg)
GA 18 VSD+ 380-460V	380	390	760	367
GA 22 VSD+ 380-460V	380	390	760	363
GA 26 VSD+ 380-460V	380	390	765	373
GA 30 VSD+ 380-460V	380	390	765	376
GA 37 VSD+ 380-460V	380	390	765	376

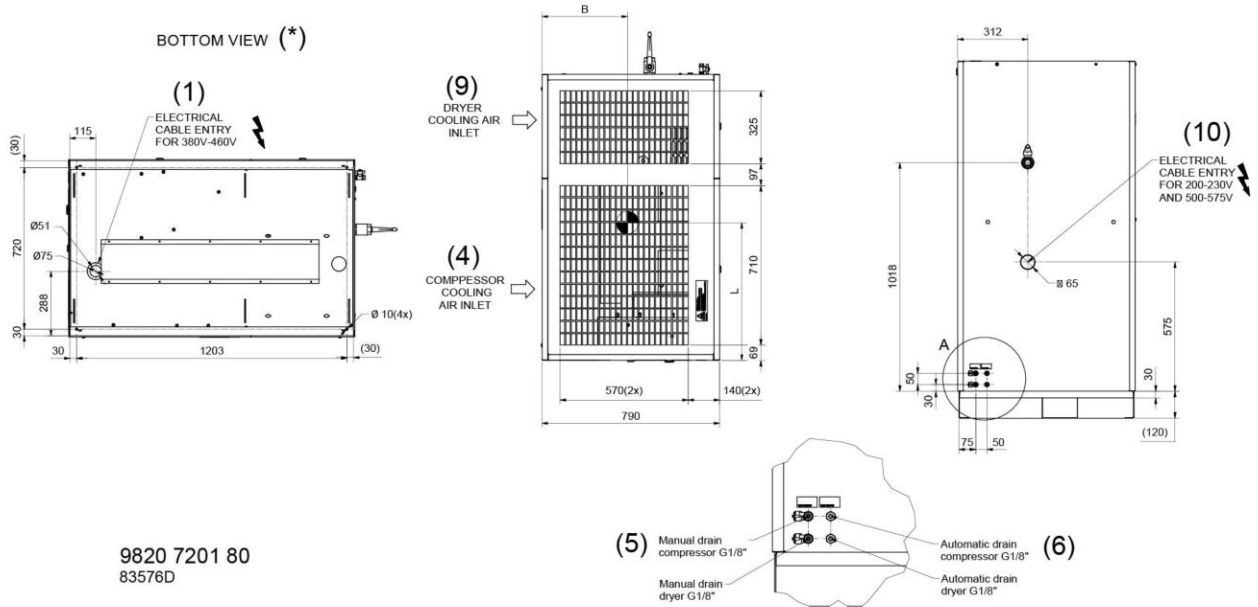
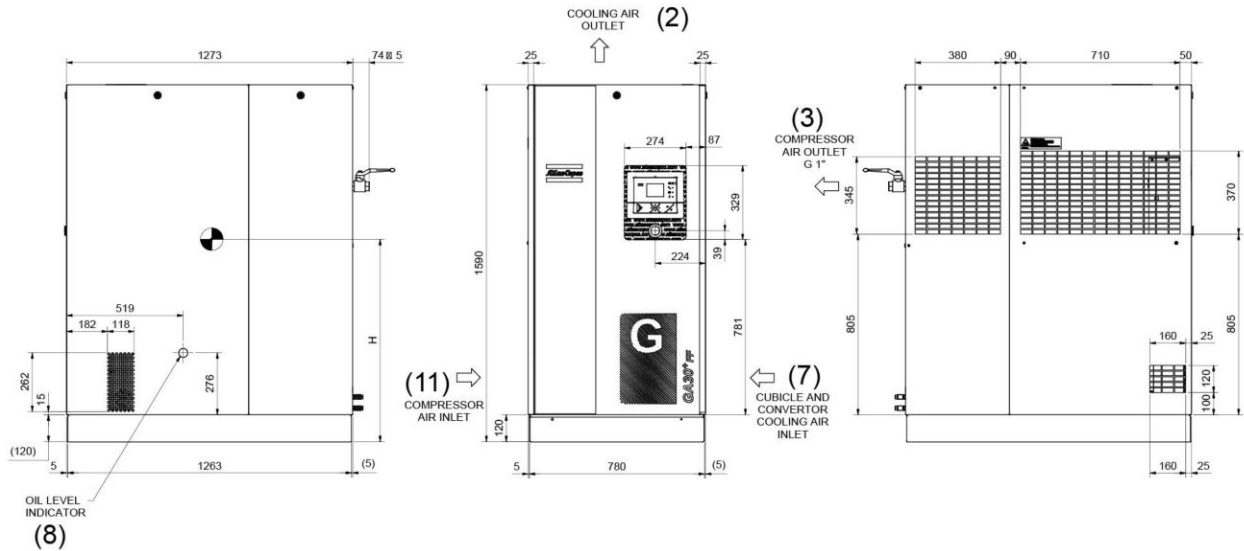

9820 7201 80
83576D

Centre of gravity and weight

Type	L (mm)	B (mm)	H (mm)	Weight (kg)
GA 18 VSD+ FF 380-460V	580	390	330	480
GA 18 VSD+ FF with trafo 200-230V	690	360	310	635
GA 18 VSD+ FF with trafo 500-575V	635	375	310	545
GA 18 VSD+ with trafo 200-230V	640	355	300	570
GA 18 VSD+ with trafo 500-575V	565	370	300	480
GA 22 VSD+ FF 380-460V	580	390	330	485
GA 22 VSD+ FF with trafo 200-230V	705	355	310	670
GA 22 VSD+ FF with trafo 500-575V	640	375	310	550
GA 22 VSD+ with trafo 200-230V	660	350	295	610
GA 22 VSD+ with trafo 500-575V	575	370	300	490
GA 26 VSD+ FF 380-460V	580	390	330	490
GA 26 VSD+ FF with trafo 200-230V	710	355	300	700
GA 26 VSD+ FF with trafo 500-575V	645	375	310	570
GA 26 VSD+ with trafo 200-230V	670	350	295	630
GA 26 VSD+ with trafo 500-575V	585	365	300	500
GA 30 VSD+ FF 380-460V	580	390	335	500
GA 30 VSD+ FF with trafo 200-230V	740	350	305	755
GA 30 VSD+ FF with trafo 500-575V	670	370	315	590
GA 30 VSD+ with trafo 200-230V	690	340	290	680
GA 30 VSD+ with trafo 500-575V	595	365	300	520
GA 37 VSD+ FF 380-460V	580	390	335	500
GA 37 VSD+ FF with trafo 200-230V	740	350	305	735
GA 37 VSD+ FF with trafo 500-575V	670	370	315	630
GA 37 VSD+ with trafo 200-230V	690	340	290	655
GA 37 VSD+ with trafo 500-575V	595	365	300	560

Dimensions +/- 10 mm

Weights (oil included) +/- 10 kg

Reference	Designation
1	Electric cable entry for 380 V - 460 V (use the cable tray inside the bottom of the frame)
2	Cooling air outlet
3	Compressor air outlet
4	Compressor cooling air inlet
5	Manual drain
6	Automatic drain
7	Cubicle and converter cooling air inlet
8	Oil level indicator
9	Dryer cooling air inlet
10	Electric cable entry for 200 - 230 V and 500 - 575 V
11	Compressor air inlet
*	Bottom view

4.2 Installation proposal

Compressor room example

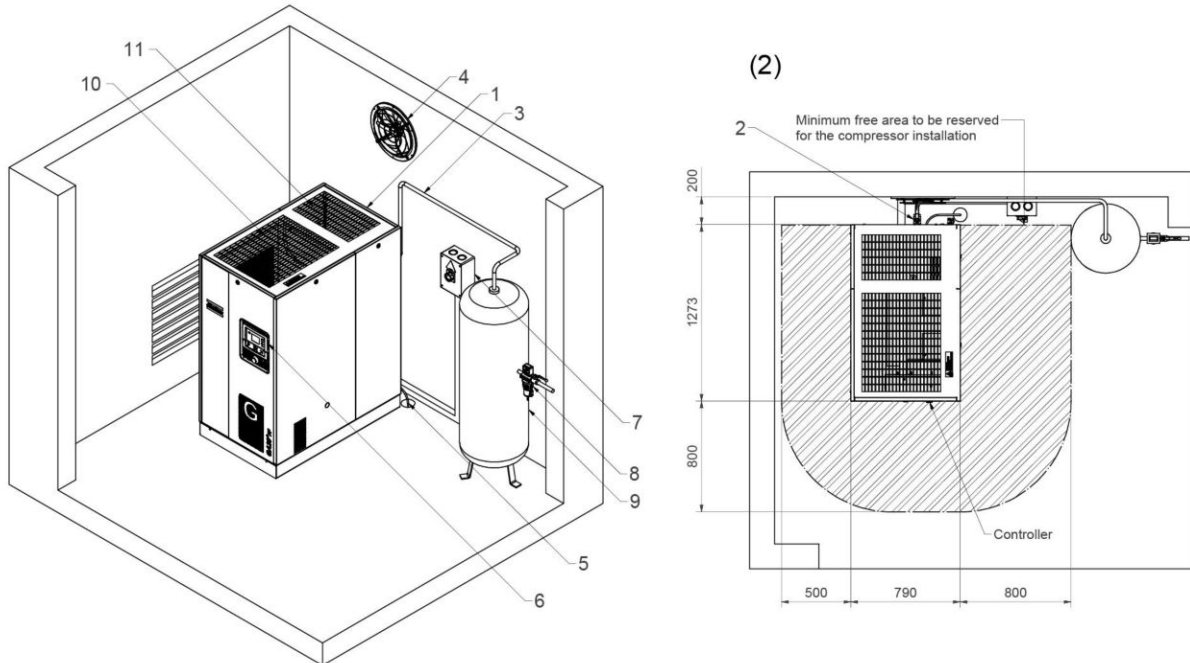

VENTILATION PROPOSALS (1)

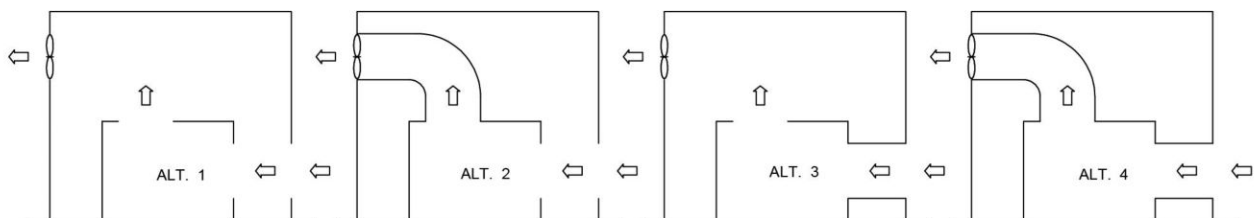

9820 7201 81
83577D

Compressor room example

Text on figure

1	Ventilation proposals
2	Minimum free area to be reserved for the compressor installation

Description

1	Compressor unit: Install the compressor unit on a solid, level floor suitable for taking the weight.
2	Position of the compressed air outlet valve.

3	<p>Delivery pipe: The pressure drop over the air delivery pipe can be calculated as follows: $\Delta p = (L \times 450 \times Q_c^{1.85}) / (d^5 \times P)$, with d = inner diameter of the pipe in mm Δp = pressure drop (recommended maximum: 0.1 bar (1.5 psi)) L = length of the pipe in m P = absolute pressure at the compressor outlet in bar(a) Q_c = free air delivery of the compressor in l/s Connect air outlet pipe of the compressor on top of the main air net pipe. In this way, there is a minimum carry-over of condensate residue.</p>
4	<p>Ventilation: When you install the inlet grids and ventilation fan, make sure that no re-circulation of cooling air into the compressor or into the dryer is possible. The maximum air velocity through the grids is 5 m/s (16.5 ft/s). The maximum air temperature at the compressor intake is 46 °C (115 °F). The minimum air temperature at the compressor intake is 0 °C (32 °F). Alternatives 1 and 3: the required ventilation to limit the compressor room temperature is calculated as follows:</p> <ul style="list-style-type: none"> • Q_v = 1.24 N/ΔT (for units without dryer) • Q_v = 1.29 N/ΔT (for units with dryer) <p>Q_v = Required ventilation capacity in m³/s N = Shaft input of compressor in kW ΔT = Temperature increase in compressor room in °C Alternatives 2 and 4: Make sure that the cooling air duct of the air/oil cooler is separated from the cooling air duct of the dryer. The maximum pressure drop over the additional air/oil ducts is limited to 20 Pa for the standard fans.</p>
5	<p>Drain pipes: Make sure that the drain pipes to the drain collector do not dip into the water of the drain collector. Atlas Copco has oil/water separators (type OSD or OSCi) to separate the major part of the oil from the condensate to ensure that the condensate meets the requirements of the environmental codes.</p>
6	<p>Control module with monitoring panel.</p>
7	 <p>Power supply cable: Have the power supply cable installed by a qualified electrician. In case of an IT network, consult Atlas Copco. To preserve the protection degree of the electric cubicle and to protect its components from dust from the environment, it is mandatory to use a proper cable gland when connecting the supply cable to the compressor.</p>
8	<p>Filter, type DD for general purposes The filter traps solid particles down to 1 micron with a max. oil carry-over of 0.5 mg/m³. A high-efficiency filter, type PD, may be installed downstream of a DD filter. This filter traps solid particles down to 0.01 micron with a max. oil carry-over of 0.01 mg/m³. If oil vapours and odours are undesirable, install a QD type filter downstream of the PD filter. Install bypass pipes over each filter together with ball valves. This ensures that service operations do not disturb the compressed air delivery .</p>
9	<p>Air tank: Install the air tank (optional) in a frost free room, on a solid level floor suitable for taking the weight. Install a safety valve on the air tank.</p>
10	<p>Outlet cooling air grating of the air cooler and the oil cooler.</p>
11	<p>Outlet cooling air grating of the dryer.</p>

Safety



Apply all relevant safety precautions, including those mentioned in this book.

Outdoor/altitude operation

The compressors are not designed for outdoor use.

The compressors can only be used in temperatures above 0 °C (+32 °F). If frost might occur, the appropriate measures should be taken to avoid damage to the machine and its ancillary equipment. In this case, consult Atlas Copco.

Also if operating above 1000 m (3300 ft), consult Atlas Copco.

Moving/lifting

The compressor can be moved by a lift truck using the slots in the frame. Take care not to damage the bodywork during lifting or transport. Before lifting, reinstall the transport securing bolts. Make sure that the forks protrude from the other side of the frame. The compressor can also be lifted after inserting beams in the slots. Make sure that the beams cannot slide and that they protrude from the frame equally. The chains must be held parallel to the bodywork by chain spreaders in order not to damage the compressor. The lifting equipment must be placed in such a way that the compressor is lifted perpendicularly. Lift gently and avoid twisting.



In case of units equipped with the Lifting Device Option, it is not allowed to lift the compressor if the canopy parts or lifting supports are not completely installed. When the compressor is being lifted, it is also forbidden to come under the load or to perform maintenance activities to it.

Acclimatization



When moving the compressor into an installation room, forming of condense can occur on some components. To avoid dew harming of electrical components, ensure at least 2 hours of acclimatization before switch on the compressor.

4.3 Electrical connections



Working with machinery controlled by a frequency converter requires special safety precautions. These safety precautions depend on the kind of network used (TN, TT, IT system). Consult Atlas Copco.



Most compressors are designed for use in TT/TN networks and are intended for industrial environments where the electrical supply is separated from the residential/commercial supply network. To use the machine in light industrial, commercial or residential environments with a shared supply network or in an IT network, extra measures can be required: contact Atlas Copco.

Electrical connections for GA 18 VSD+ up to GA 30 VSD+

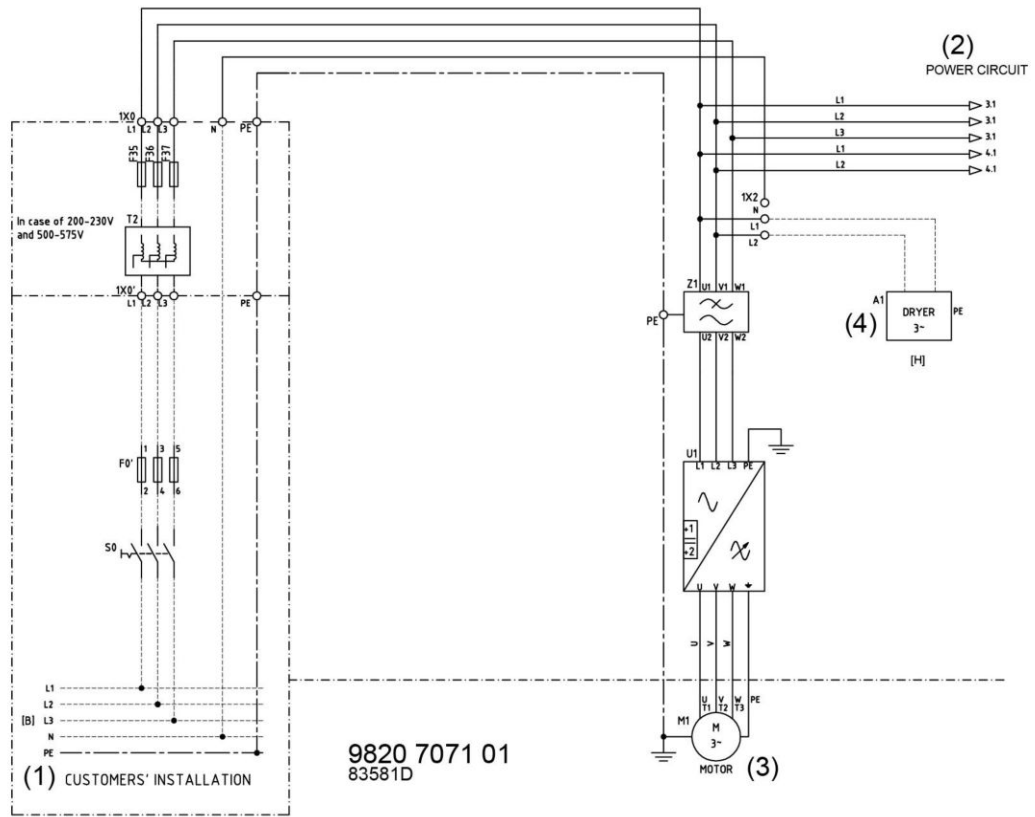

Electrical connections for GA 37 VSD+

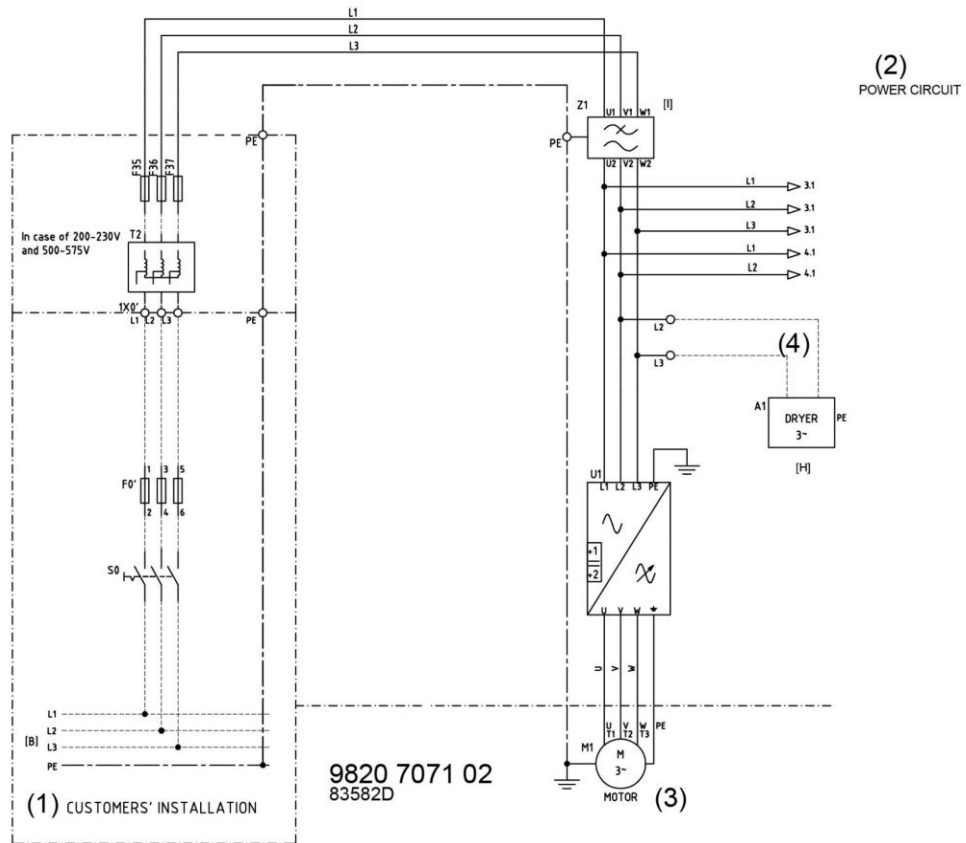

Electrical connections diagram, typical example

Reference	Designation
(1)	Customer's installation
(2)	Power circuit
(3)	Motor
(4)	Dryer

Note

The complete electrical diagram can be found in the electrical cubicle.

Description

	You find the correct position for the electrical connection on the Dimension drawings .
--	---

1. Provide an isolating switch.
2. Check that the motor cables and wires inside the electric cabinet are clamped tight to their terminals.
3. Check the fuses. See section [Electric cable size and fuses](#)
4. Connect the power supply cables to terminals EMC filter (Z1)
5. Connect the earth conductor to the earth bolt (PE).



To preserve the protection degree of the electric cubicle and to protect its components from dust from the environment, it is mandatory to use a proper cable gland when connecting the supply cable to the compressor.

Compressor control modes

See also section [Control mode selection](#).

The following control modes can be selected:

- **Local control:** The compressor will react to commands entered by means of the buttons on the control panel. Compressor start/stop commands via Clock function are active, if programmed.
- **Remote control:** The compressor will react to commands from external switches. Emergency stop remains active. Compressor start/stop commands via Clock function are still possible.



Have the modifications checked by Atlas Copco.
Stop the compressor and switch off the voltage before connecting external equipment.
Only potential-free contacts are allowed.

- **LAN control:** The compressor is controlled via a local network. Consult Atlas Copco.

Compressor status indication

The Elektronikon controller is provided with potential-free auxiliary NO contacts (NO = normally open) (K05, K07 and K08) for remote indication of:

- Manual or automatic operation (K07)
- Warning condition (K08)
- Shut-down condition (K05)

Maximum contact load: 10 A / 250 V AC.

Stop the compressor and switch off the voltage before connecting external equipment. Consult Atlas Copco.

4.4 Pictographs

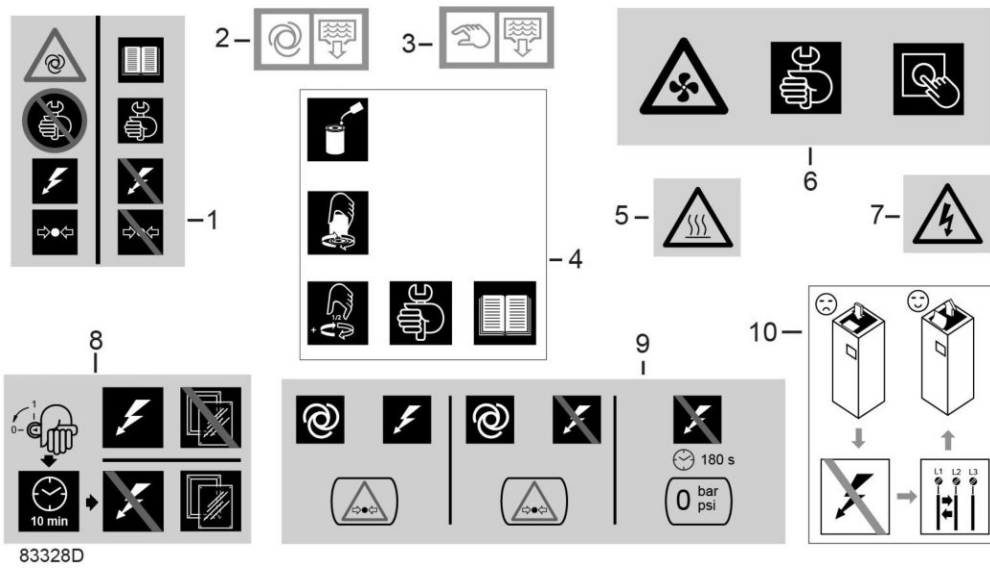



Pictographs

Reference	Designation
1	Switch off the voltage and depressurize the compressor before starting maintenance or repairs
2	Automatic condensate drain
3	Manual condensate drain
4	Lightly oil the gasket of the oil filter, screw it on and tighten by hand (approx. half a turn)
5	Warning, hot surface
6	Stop the compressor before cleaning the coolers
7	Warning, voltage
8	Switch off the voltage and wait at least 10 minutes before maintenance
9	Compressor remains pressurized for 180 seconds after switching off the voltage
10	If the rotation direction is wrong, open the isolating switch in the voltage supply line and reverse two incoming electric lines

5 Operating instructions

Initial start-up

	The operator must apply all relevant Safety precautions . Also consult section Problem solving .
---	--

	For the location of the air outlet valve and the drain connections, see sections Introduction and Condensate system .
---	---

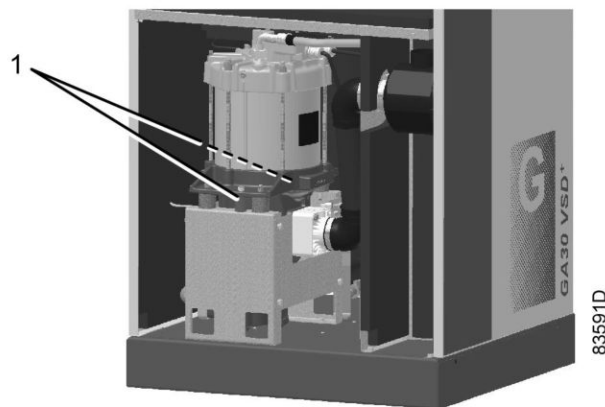

-	Remove the canopy panel(s) in order to get access to the internal components. Remove the red transport spacers and the related bolts under motor (1).
-	Check that the electrical connections correspond to the local codes and that all wires are clamped tight to their terminals. The installation must be earthed and protected against short circuits by fuses of the inert type in all phases. An isolating switch must be installed near the compressor.
-	Check the voltage selecting wires at the primary side of transformer T1.
-	Fit air outlet valve (AV); see section Introduction for the position of the valve. Close the valve. Connect the air net to the valve.
-	Fit the manual condensate drain valve (Dm). Close the valve.
-	Connect the condensate drain outlets to a drain collector. See section Condensate system for the position of the valves. The drain pipes to the drain collector must not dip into the water. For draining of pure condensate water, install an oil/water separator which is available from Atlas Copco as an option. If the pipes have been fitted outside the room where freezing is possible, they must be insulated.

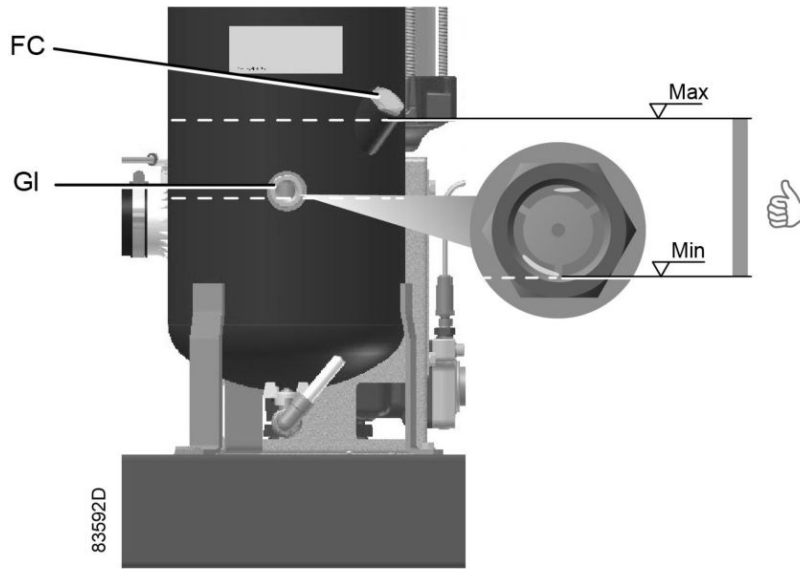

- Check the oil level, the oil level should reach the bottom of the oil filler neck (FC). Minimum level should reach the oil sight glass (GI) when the compressor is stopped. If needed, top up the oil. Take care that no dirt drops into the oil system. Refit and tighten the filler plug (FC).
- **Provide labels, warning the operator that:**
 - The compressor may automatically restart after voltage failure (if activated, consult Atlas Copco).
 - The compressor is automatically controlled and may be restarted automatically.
 - The compressor may be remotely controlled.

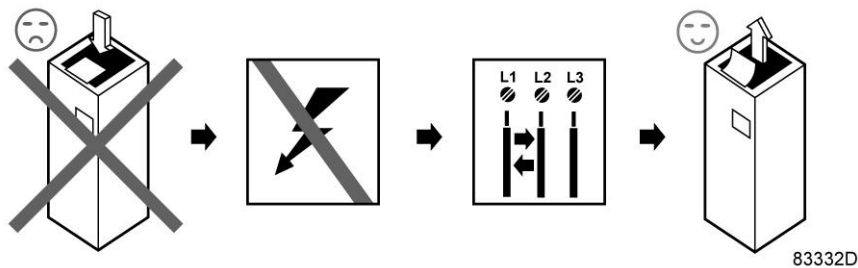

- Check the rotation direction of the axial fan motor. If the rotation direction is wrong, open the isolating switch in the voltage supply line and reverse two incoming electric lines.
- Check the programmed settings. Consult section [Programmable settings](#).
- Open the air outlet valve. Start and run the compressor for a few minutes. Check that the compressor operates normally.

Starting

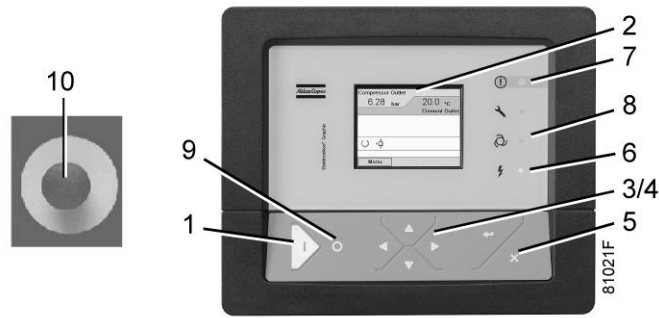

Control panel Elektronikon® Graphic

Step	Action
-	Open the air outlet valve.
-	Switch on the voltage. Check that voltage on LED (6) lights up.
-	Press start button (1) on the control panel. The compressor starts running and the automatic operation LED (8) lights up.

During operation

	Keep the panels closed during operation.
	When the motors are stopped and LED (8) (automatic operation) is alight, the motors may start automatically.
	When the automatic operation LED (8) is lit, the regulator is automatically controlling the compressor, i.e. loading, unloading, stopping of the motors and restarting!

Regularly check the oil level during operation.

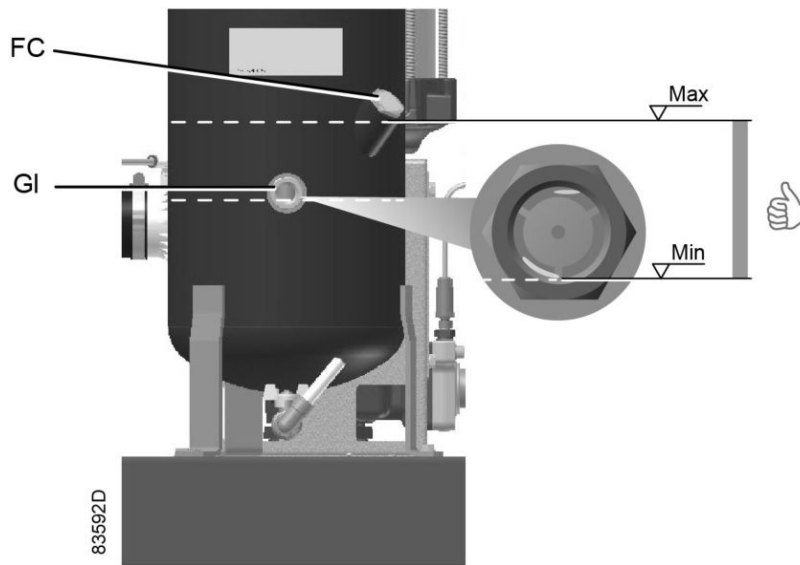

A few minutes after stopping, the oil level should reach the bottom of the oil filler neck (FC).

If the oil level is too low, wait until the compressor has depressurized. Push the emergency stop button (10) to avoid the compressor to start unexpectedly. Next, close the air outlet valve and open the manual drain valve (Dm) until the air system between oil separator/air receiver vessel and outlet valve is fully depressurized. See section [Condensate system](#) for location of the outlet valve and water drain.

Unscrew oil filler plug (FC) one turn to permit any pressure left in the system to escape. Wait a few minutes. Remove the plug and add oil until the level reaches the filler opening. Fit and tighten the plug (FC).

On compressors with an Elektronikon® Graphic controller, unlock the emergency stop button (10), select the STOP icon on the display and press reset before restarting.

Regularly check that condensate is discharged during operation. See section [Condensate system](#). The amount of condensate depends on environmental and working conditions.

Checking the display

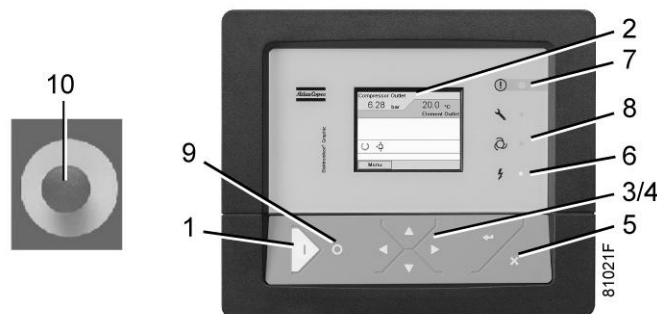

Control panel Elektronikon® Graphic

Check the display (2) regularly for readings and messages. The display normally shows the compressor outlet pressure, while the status of the compressor is indicated by means of a number of icons. Remedy the trouble if alarm LED (7) is lit or flashes, see section [Icons used](#). The display (2) will show a service message if a service plan interval has been exceeded or if a service level for a monitored component has been exceeded. Carry out the service actions of the indicated plans or replace the component and reset the relevant timer, see section [Service menu](#).

Stopping

-	Press stop button (9). Automatic operation LED (8) goes out and the compressor stops.
-	<p>To stop the compressor in the event of an emergency, press emergency stop button (10). Alarm LED flashes (7).</p> <ul style="list-style-type: none"> Remedy the problem cause, unlock the button by pulling it out. Navigate to the Stop icon on the display by means of the navigation keys (3/4) and press the Select key. Press Reset. <p>Do not use emergency stop button (10) for normal stopping!</p>
-	Close the air outlet valve.
-	Press the test button on top of the electronic water drain(s) to the depressurize the piping between air receiver and outlet valve, next open the manual drain valve (Dm). See section Condensate system . Switch off the voltage.

Taking out of operation

-	Disconnect the compressor from the mains.
-	Unscrew the oil filler plug only one turn to permit any pressure in the system to escape.
-	Shut off and depressurise the part of the air net which is connected to the outlet valve. Disconnect the compressor air outlet pipe from the air net.
-	Drain the oil.
-	Drain the condensate circuit and disconnect the condensate piping from the condensate net.

6 Maintenance

6.1 Preventive maintenance schedule

Control panel

Warning



Before carrying out any maintenance, repair work or adjustments, proceed as follows:

- Stop the compressor.
- Close the air outlet valve and open the condensate drain valve to depressurize the air system between air receiver and outlet valve.
- Press the emergency stop button (10).
- Switch off the voltage.
- Depressurise the compressor.

For detailed instructions, see section [Problem solving](#).

The operator must apply all relevant [Safety precautions](#).

Warranty - Product Liability

Use only authorised parts. Any damage or malfunction caused by the use of unauthorised parts is not covered by Warranty or Product Liability.

Service kits

For overhauling or carrying out preventive maintenance, service kits are available (see section [Service kits](#)).

Service contracts

Atlas Copco offers several types of service contracts, relieving you of all preventive maintenance work. Consult your Atlas Copco Customer Centre.

General

When servicing, replace all removed O-rings and washers.

Intervals

The local Atlas Copco Customer Centre may overrule the maintenance schedule, especially the service intervals, depending on the environmental and working conditions of the compressor.

The longer interval checks must also include the shorter interval checks.

Service plans for compressors with an Elektronikon® Graphic controller

Besides the daily and 3-monthly checks, preventive service operations are specified in the schedule below.

Each plan has a programmed time interval at which all service actions belonging to that plan are to be carried out. When reaching the interval, a message will appear on the screen indicating which service plans are to be carried out. After servicing, the intervals must be reset, see section [Service menu](#).

Preventive maintenance schedule

Daily and 3-monthly check list

Period	Operation
Daily	<p>Check oil level. If needed, top up the oil (see section Operations instructions / During operation)</p> <p>Check readings on display.</p> <p>Check that condensate is discharged during operation.</p> <p>Drain condensate.</p>
monthly	<p>Check that condensate is discharged when pressing the test button on top of the electronic water drain.</p>
3-monthly (1)	<p>Check coolers, clean if necessary.</p> <p>Remove the air filter element and inspect. Replace damaged or heavily contaminated elements.</p> <p>Check the filter elements of the electric cabinet. Replace if necessary</p>

Check list for compressors with dryer

Period	Operation
Daily	<p>Check that condensate is discharged during operation.</p>
Monthly (1)	<p>Drain inspection: Check that condensate is discharged when pressing the test button on top of the electronic water drain(s).</p> <p>Condenser cleaning:</p> <ul style="list-style-type: none"> • Stop the compressor, close the air outlet valve and switch off the voltage. • Remove any dirt on the condenser inlet with a vacuum cleaner. • Next, clean with an air jet in the reverse direction to normal flow. Use low pressure air. Keep the compressed air nozzle more than 30 cm away from the condenser to avoid damaging the of condenser fins. • Remove dust from inside the dryer, e.g. with a vacuum cleaner. <p>Do not use water or solvents to clean the condenser.</p>

(1): More frequently when operating in a dusty atmosphere.

Preventive Maintenance schedule programmed in the Elektronikon

Running hours	Operation
4000 (1)	Change oil and oil filter. (not for Roto-Xtend Duty Fluid) Replace the air filter element. Replace the oil separator element. Check condition of the air intake hose between air filter and compressor element (where applicable). Check pressure and temperature readings. Check operation of cooling fans of converter. Check blow-off solenoid valve after stopping and pressing the emergency stop button. Clean coolers. Check and clean cooling fan assembly.
8000 (2)(3)	All the actions for 4000 hrs. Change oil and oil filter. Replace the filter elements of the electric cabinet. Replace the non return valve of the scavenge line and blow out the restriction nozzle. Replace the minimum pressure valve, and replace the thermostatic valve. Remove carefully. Replace the electronic drain valve. Carry out a LED/display test. Check for possible air and oil leakages. Have safety valve tested.

(1): or yearly, whichever comes first

(2): or every 2 years, whichever comes first

(3): For all 8000 hours actions, contact Atlas Copco.

The indicated oil exchange intervals are valid for standard operating conditions (see section [Reference conditions and limitations](#)) and nominal operating pressure (see section Compressor data). Exposure of the compressor to external pollutants, operation at high humidity combined with low duty cycles or operation at higher temperatures may require a shorter oil exchange interval. Contact Atlas Copco if in doubt.

Roto-Inject Fluid

Ambient temperature	Element outlet temperature	Exchange interval *	Maximum time interval *
up to 25 °C	up to 90 °C	4000 hours	1 year
from 25 °C up to 35 °C	from 90 °C up to 100 °C	3000 hours	1 year
more than 35 °C	more than 100 °C	2000 hours	1 year

Roto-Xtend Duty Fluid

Ambient temperature	Element outlet temperature	Exchange interval *	Maximum time interval *
up to 40 °C	up to 110 °C	8000 hours	2 year
more than 40°C	more than 110 °C	6000 hours	2 year

Roto-Foodgrade Fluid

Ambient temperature	Element outlet temperature	Exchange interval *	Maximum time interval *
up to 25 °C	up to 90 °C	4000 hours	1 year
from 25 °C up to 35 °C	from 90 °C up to 100 °C	3000 hours	1 year
more than 35 °C	more than 100 °C	2000 hours	1 year

* Whichever comes first.

Important

	<ul style="list-style-type: none"> • Always consult Atlas Copco if a timer setting has to be changed. • For the change interval of oil and oil filter in extreme conditions of temperature, humidity or cooling air, consult your Atlas Copco Customer Centre. • Any leakage should be attended to immediately. Damaged hoses or flexible joints must be replaced.
---	---

6.2 Oil specifications

It is strongly recommended to use genuine Atlas Copco Lubricants. They are the result of years of field experience and research. See section Preventive maintenance schedule for the advised replacement intervals and consult your Spare Parts list for part number information.

	<p>Avoid mixing lubricants of different brands or types as they may not be compatible and the oil mix may have inferior properties. A label, indicating the type of oil filled ex factory, is stuck on the air receiver/oil tank.</p>
---	---

Roto-Inject Fluid

Atlas Copco's Roto-Inject Fluid is a specially developed lubricant for use in single stage oil-injected screw compressors. Its specific composition keeps the compressor in excellent condition. Roto-Inject Fluid can be used for compressors operating at ambient temperatures between 0 °C (32 °F) and 40 °C (104 °F). If the compressor is regularly operating in ambient temperatures above 35 °C (95 °F), oil lifetime is reduced significantly. In such case use Roto-Xtend Duty Fluid for a longer interval for oil exchange.

If the compressor is regularly operating in ambient temperatures above 35 °C (95 °F), oil lifetime is reduced (see table oil lifetime [Preventive maintenance schedule](#)).

Roto-Xtend Duty Fluid

Atlas Copco's Roto-Xtend Duty Fluid is a high quality synthetic lubricant for oil-injected screw compressors which keeps the compressor in excellent condition. Because of its excellent oxidation stability, Roto-Xtend Duty Fluid can be used for compressors operating at ambient temperatures between 0 °C (32 °F) and 46 °C (115 °F).

If the compressor is regularly operating in ambient temperatures above 40 °C (104 °F), oil lifetime is reduced (see table oil lifetime [Preventive maintenance schedule](#)).

Roto-Foodgrade Fluid

Special oil, delivered as an option.

Atlas Copco's Roto-Foodgrade Fluid is a unique high quality synthetic lubricant, specially created for oil-injected screw compressors that provide air for the food industry. This lubricant keeps the compressor in excellent condition. Roto-Foodgrade Fluid can be used for compressors operating at ambient temperatures between 0 °C (32 °F) and 40 °C (104 °F).

If the compressor is regularly operating in ambient temperatures above 35 °C (95 °F), oil lifetime is reduced (see table oil lifetime [Preventive maintenance schedule](#)).

6.3 Drive motor

Bearing maintenance

The motor bearing is lubricated by oil injection. Re-greasing is not necessary.

6.4 Air filter

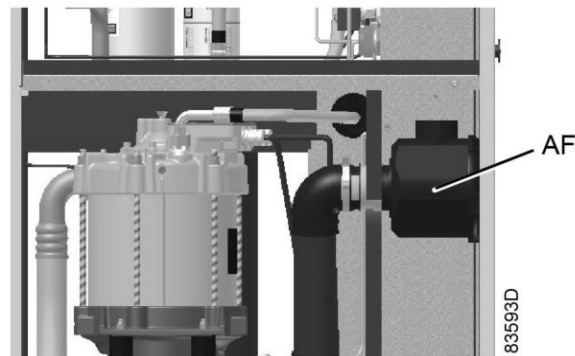

Location of air filter

Procedure

1. Stop the compressor. Switch off the voltage.
2. Remove the cover of the air filter (AF) by turning it anti clockwise. Remove the filter element.
3. Fit the new element and the cover.
4. Reset the air filter service warning.

For compressors equipped with an Elektronikon® Graphic regulator, see section [Service menu](#).

6.5 Oil, oil filter and oil separator change

Warning



The operator must apply all relevant [Safety precautions](#). Always drain the compressor oil at all drain points. Used oil left in the compressor can contaminate the oil system and can shorten the lifetime of the new oil. Never mix lubricants of different brands or types as they may not be compatible and the oil mix will have inferior properties. A label, indicating the type of oil filled ex-factory, is stuck on the air receiver/oil tank.

Procedure

- Run the compressor until warm and stop the compressor.
 - Close the air outlet valve and switch off the voltage.
 - Wait 3 minutes for the compressor to depressurise the vessel.
 - Open the condensate drain valve to depressurise the cooler. (see condensate system) and close again.
 - Unscrew the oil filler plug (FC) just one turn to permit any remaining pressure in the system to escape.
 - Cover the duct of the heat sink on the electric cabinet.
2. Remove the vent plug (VP) of the oil cooler.

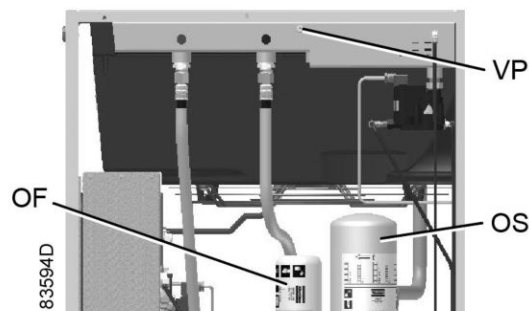

Vent plug, oil cooler

- Open the oil drain valve (Do).
 - Hold the oil drain hose (1) downward to drain the oil.

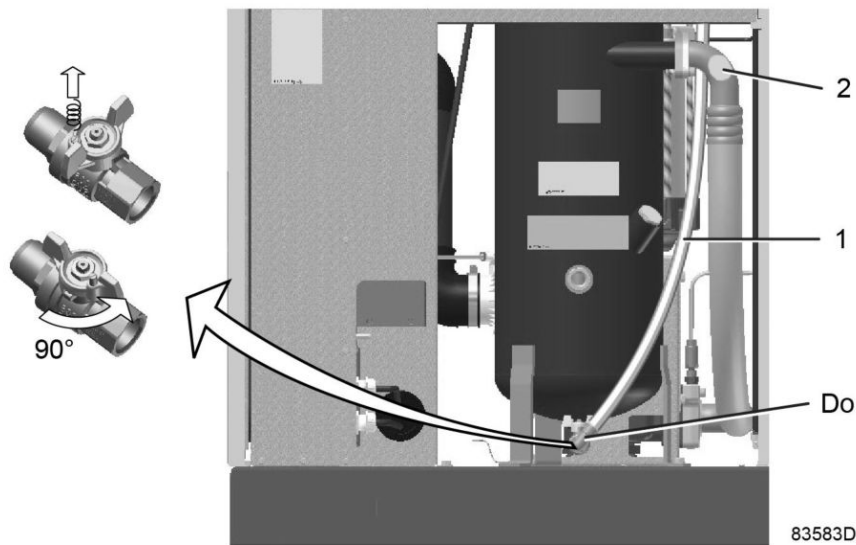

4.
 - Disconnect the air hose (2) at the top on the vessel.
 - Move the hose downward to drain the oil from the element.
 - Remove the oil filter (OF). **Be aware that this filter has a left thread connection.**
 - Remove the oil separator (OS). **Be aware that this filter has a left thread connection.**

Collect the oil in a collector and deliver it to the local collection service. Refit the vent plugs after draining.
5.
 - Close the oil drain valve (Do).
 - Refit the drain hose at the top of the air receiver.
6.
 - Clean the seat on the manifold. Lubricate the gasket of the new oil filter and screw it into place. Tighten firmly by hand.
 - Clean the seat on the manifold. Lubricate the gasket of the new oil separator and screw it into place. Tighten firmly by hand.
7. Remove filler plug (FC).
Fill the air receiver with oil until the level reaches the filler neck.

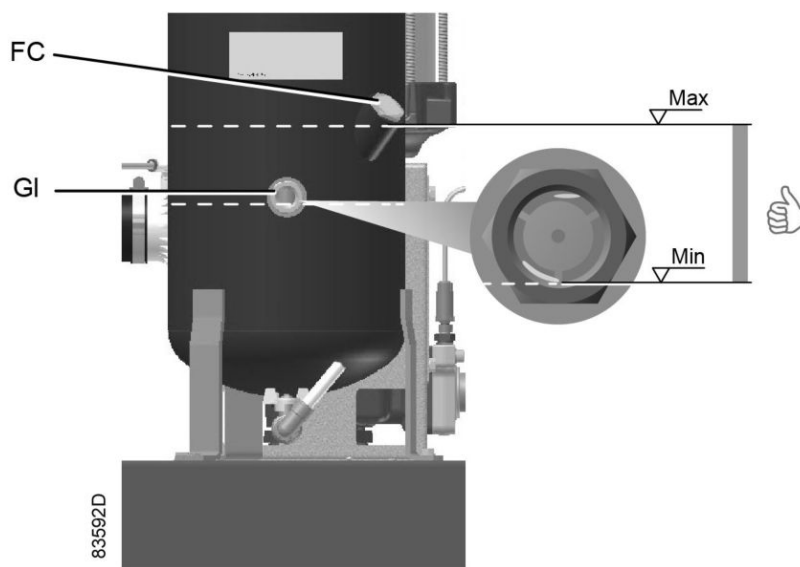

- Take care that no dirt drops into the system. Refit and tighten filler plug (FC).
8. Run the compressor loaded for a few minutes. Stop the compressor.
 9.
 - Close the air outlet valve and switch off the voltage.
 - Wait 3 minutes for the compressor to depressurise the vessel.

- Open the condensate drain valve (Dm) to depressurise the cooler. (see [Condensate system](#)) and close again.
 - Unscrew the oil filler plug (FC) just one turn to permit any remaining pressure in the system to escape.
10. • Fill the air receiver (AR) with oil until the level reaches the filler neck. (see [Operating instructions / During operation](#))
- Refit and tighten filler plug (FC).
- When the oil level is too low, go back to step 7.

6.6 Coolers

General

Keep the coolers clean to maintain their efficiency.

Procedure

- Stop the compressor, close the air outlet valve and switch off the voltage.
- Cover all parts under the coolers.
- Remove the service plate (1) at the fan compartment.

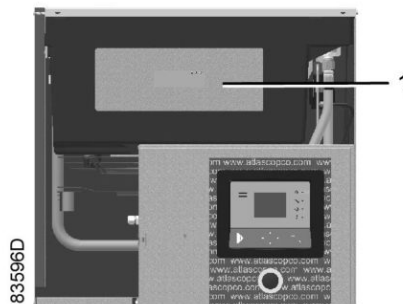

- Remove dirt from the coolers with a fibre brush. Brush in the direction of the cooling fins. Remove dirt from the fan with a fibre brush.
- Clean with an air jet in the reverse direction to normal flow.
- If it is necessary to wash the coolers with a cleaning agent, consult Atlas Copco.

	<p>After maintenance on the fan and on the coolers: Remove the loose parts that are used as cover.</p>
--	--

- Mount the service plate (1) at the fan compartment.

Procedure for compressors with dryer.

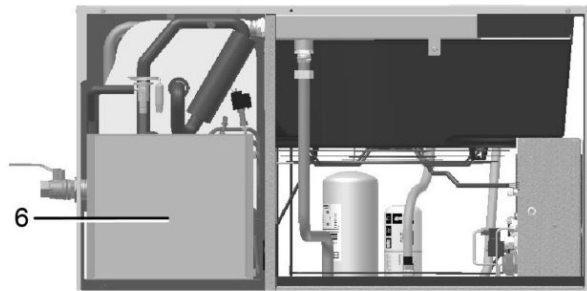

Location of the condenser of the dryer

- Remove dirt on the inlet of the condenser (6) with a fibre brush.
- Clean with an air jet in the reverse direction to normal flow.
- Clean the condenser area with a fibre brush.

6.7 Dryer maintenance instructions

Safety precautions

Refrigeration dryers of ID type contain refrigerant HFC.

When handling refrigerant, all applicable [safety precautions](#) must be observed. Please be specifically aware of the following points:

- Contact of refrigerant with the skin will cause freezing. Special gloves must be worn. If contacted with the skin, the skin should be rinsed with water. On no account may clothing be removed.
- Fluid refrigerant will also cause freezing of the eyes; always wear safety glasses.
- Refrigerant is harmful. Do not inhale refrigerant vapours. Check that the working area is adequately ventilated.

Be aware that certain components such as the refrigerant compressor and the discharge pipe can become quite hot (up to 110 °C - 230 °F). Therefore, wait until the dryer has cooled down before removing the panels.

Before starting any maintenance or repair work, switch off the voltage and close the air inlet and outlet valves.

Local legislation

Local legislation may stipulate that:

- Work on the refrigerant circuit of the cooling dryer or on any equipment which influences its function must be undertaken by an authorised control body.
- The installation should be checked once a year by an authorised control body.

6.8 Safety valves

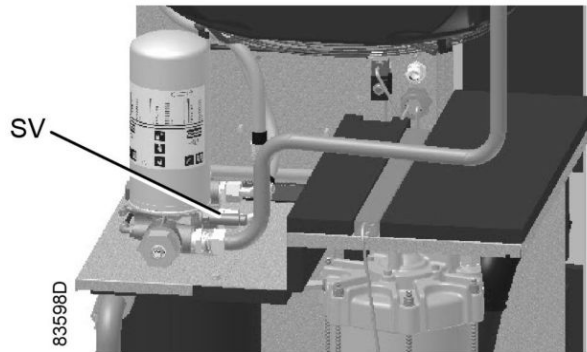

Location of safety valve

Testing



The safety valve (SV) test can only be performed by authorized personnel and is protected by a security code.
Refer to Elektronikon® Graphic controller, [Test menu](#)

If the safety valve does not open at the set pressure stamped on the valve, it needs to be replaced.

Warning



No adjustments are allowed. Never run the compressor without safety valve.

6.9 Service kits

Service kits

For overhauling and for preventive maintenance, a wide range of service kits is available. Service kits comprise all parts required for servicing the component and offer the benefits of genuine Atlas Copco parts while keeping the maintenance budget low.

Also a full range of extensively tested lubricants, suitable for your specific needs is available to keep the compressor in excellent condition.

Consult the Spare Parts List for part numbers.

6.10 Storage after installation

Procedure

Run the compressor regularly, e.g. twice a week, until warm.



If the compressor is going to be stored without running from time to time, protective measures must be taken. Consult your supplier.

6.11 Disposal of used material

Used filters or any other used material (e.g. desiccant, lubricants, cleaning rags, machine parts, etc.) must be disposed of in an environmentally friendly and safe manner, and in line with the local recommendations and environmental legislation.



Be careful when removing the electric motor. The rotor contains magnetic parts.

7 Problem solving

Warning

	<p>Before carrying out any maintenance, repair work or adjustment, stop compressor, wait 3 minutes and close the air outlet valve.</p> <p>Press the test button on top of the electronic water drain until the air system between the air receiver and outlet valve is fully depressurized.</p> <p>Press the emergency stop button and switch off the voltage.</p> <p>Depressurise the compressor by opening the oil filler plug one turn.</p> <p>For location of components, see sections:</p> <ul style="list-style-type: none"> • Introduction. • Condensate system. • Operation instructions • Maintenance.
	Open and lock the isolating switch.
	<p>Lock the air outlet valve during maintenance or repair as follows:</p> <ul style="list-style-type: none"> • Close the valve. • Remove the screw fixing the handle with the wrench delivered with the compressor. • Lift the handle and turn it until the slot of the handle fits over the blocking edge on the valve body. • Fit the screw.
	The operator must apply all relevant Safety precautions .

Before electrical maintenance

	<p>Wait for at least 10 minutes before starting any electrical repairs as dangerous high voltage remains on the capacitors of the start and speed regulation unit during some minutes after switching off the voltage.</p>
---	--

Faults and remedies, compressor

If the alarm LED is lit or flashes, consult sections [Event history menu](#) or [Service menu](#).

Condition	Fault	Remedy
Condensate is not discharged from condensate separator during loading	Discharge flexible clogged	Check and correct as necessary

Condition	Fault	Remedy
Fan out of order	Fan overload	On GA 18 up to GA 30 VSD+, Replace fan On GA 37 VSD+, Reset the fan switch (Q15) in electrical cabinet. Replace fan if necessary

Condition	Fault	Remedy
Compressor air output or pressure below normal	Air consumption exceeds air delivery of compressor	Check equipment connected

Condition	Fault	Remedy
	Choked air filter element	Replace filter element
	Solenoid valve malfunctioning	Replace valve
	Oil separator clogged	Have element replaced
	Air leakage	Have leaks repaired
	Safety valve leaking	Have valve replaced
	Compressor element out of order	Consult Atlas Copco

Condition	Fault	Remedy
Safety valve blows	Minimum pressure valve malfunctioning	Check and have defective parts replaced
	Oil separator clogged	Have element replaced
	Safety valve out of order	Have valve checked. Replace if necessary
	On Full-Feature compressors, dryer piping clogged due to formation of ice	Have system checked by Atlas Copco

Condition	Fault	Remedy
Compressor element outlet temperature or delivery air temperature above normal	Oil level too low	Check and correct, see Operation instructions / During operation
	On air-cooled compressors, insufficient cooling air or cooling air temperature or relative humidity is too high	Check for cooling air restriction or improve ventilation of the compressor room. Avoid recirculating of cooling air. If installed, check capacity of compressor room fan
	Oil cooler clogged	Clean cooler
	By-pass valve malfunctioning	Have valve tested
	Air cooler clogged	Clean cooler
	Compressor element out of order	Consult Atlas Copco
	Degraded oil	Check service intervals, see Preventive maintenance schedule

Condition	Fault	Remedy
Low Load Alarm triggered: Compressor running with too low oil temperature over a longer period of time	Solenoid valve malfunctioning	Replace valve
	Extreme low usage of compressor	Increase loading profile (longer and/or more load cycles required) If not possible, consult Atlas Copco

Converter fault codes

If a problem is detected by the converter, a specific code (Main motor converter alarm) will appear on the Elektronikon display, together with a fault code. Below table lists the most important error codes. If another code appears, please contact Atlas Copco.

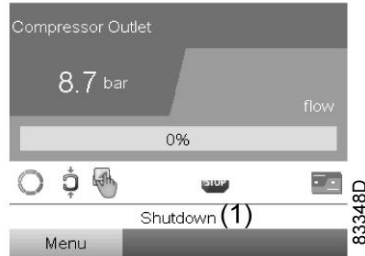

Typical display when the compressor is stopped by a shutdown

(1)	Shutdown
-----	----------

Navigate to the Stop icon or to the Protections icon and press Enter.

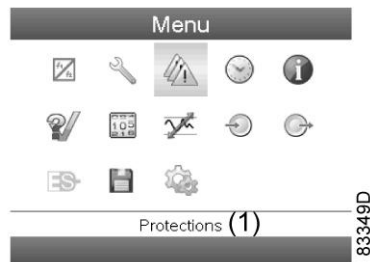

(1)	Protections
-----	-------------

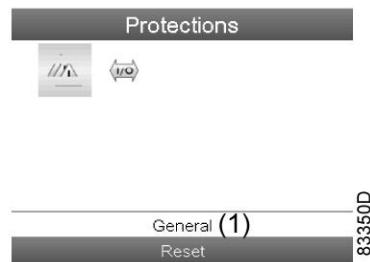

(1)	General
-----	---------

The display shows the problem (Main Motor Converter Alarm) and a fault code (31 in this case).

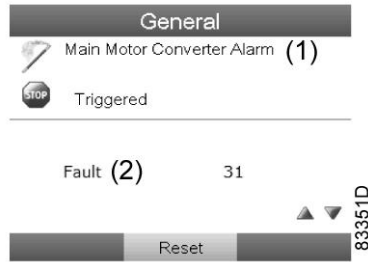

(1)	Main Motor Converter Alarm
(2)	Fault

Fault code	Cause	Actions
1	Overcurrent	Contact Atlas Copco
	Ground fault	Contact Atlas Copco
2	Too high voltage. The voltage on the converter is above the specifications.	Check the supply voltage Contact Atlas Copco.
3	Too low voltage. The voltage on the converter is below the specifications. Power quality faults	Check the supply voltage Contact Atlas Copco
		Check for loose wiring/wiring errors Check supply voltage during start up Check fuses transformer (200V, 230V, 500V and 575V units only)
4	Drive overload	Contact Atlas Copco
8	Converter overheating (heat sink)	Check the ambient temperature Check the cubicle cooling Check airflow around drive Check cooling fan and cooler contamination Contact Atlas Copco
256	Hardware fault	Contact Atlas Copco
512	Motor overload	Contact Atlas Copco
	Drive overload	Contact Atlas Copco
	Over-torque detection	Contact Atlas Copco
	Under-torque detection	Contact Atlas Copco
1024	Over-speed	Contact Atlas Copco
	Safe torque off	Check for loose wiring at inverter - Push emergency stop button Check temperature switch
8192	Output phase loss	Contact Atlas Copco
	Input phase loss	Check supply voltage Check for loose wiring/wiring errors Check supply voltage during start-up Check fuses transformer (200V, 230V, 500V and 575V units only)
16384	Communication error	Contact Atlas Copco

Fault code	Cause	Actions
TIME-OUT	Time-out communication error between Elektronikon and Inverter	Contact Atlas Copco

Faults and remedies, dryer

For all references hereafter, consult section [Air dryer](#).

Condition	Fault	Remedy
Pressure dew point too high	Air inlet temperature too high	Check and correct; if necessary, clean the aftercooler of the compressor
	Ambient temperature too high	Check and correct; if necessary, draw cooling air via a duct from a cooler place or relocate the compressor
	Shortage of refrigerant	Have circuit checked for leaks and recharged
	Refrigerant compressor does not run	See below
	Evaporator pressure too high	See below
	Condenser pressure too high	See below
Condenser pressure too high or too low	Fan control switch out of order	Replace
	Fan blades or fan motor out of order	Have checked fan/fan motor, if necessary replace
	Ambient temperature too high	Check and correct; if necessary, draw cooling air via a duct from a cooler place or relocate the compressor
	Condenser externally clogged	Clean condenser
Compressor stops or does not start	Electric power supply to compressor is interrupted	Check and correct as necessary
	Thermal protection of refrigerant compressor motor has tripped	Motor will restart when motor windings have cooled down
Electronic condensate drain remains inoperative	Electronic drain system clogged	Have system inspected Clean the filter of the automatic drain by opening the manual drain valve. Check functioning of the drain by pushing the test button
Condensate trap continuously discharges air and water	Automatic drain out of order	Have system checked. If necessary, replace the automatic drain
Evaporator pressure is too high or too low at unload	Hot gas bypass valve incorrectly set or out of order	Have hot gas bypass valve adjusted
	Condenser pressure too high or too low	See above
	Shortage of refrigerant	Have circuit checked for leaks and recharged if necessary

8 Technical data

8.1 Readings on display



Elektronikon® Graphic controller

Important



The readings mentioned below are valid under the reference conditions (see section [Reference conditions and limitations](#)).

Reference	Reading
Air outlet pressure	Depends on the setpoint (desired net pressure).
Compressor element outlet temperature	Approx. 80 °C (176 °F) (ambient temperature 20 °C + 60 °C)
Dewpoint temperature (on Full-Feature compressors)	Approx. 4 °C (39 °F).

8.2 Electric cable size and fuses

Important



- The voltage on the compressor terminals must not deviate more than 10% of the nominal voltage.
It is however highly recommended to keep the voltage drop over the supply cables at nominal current below 5% of the nominal voltage (IEC 60204-1).
- If cables are grouped together with other power cables, it may be necessary to use cables of a larger size than those calculated for the standard operating conditions.
- Use the original cable entry. See section [Dimension drawings](#).
To preserve the IP protection degree of the electric cubicle and to protect its components from dust from the environment, it is mandatory to use a proper cable gland when connecting the supply cable to the compressor.
- Local regulations remain applicable if they are stricter than the values proposed below.
- **Caution:**
 - Always double-check the fuse size versus the calculated cable size. If required, reduce fuse size or enlarge cable size.
 - Cable length should not exceed the maximum length according to IEC60204 table 10

Leakage breaker (optional)

If the installation requires a leakage breaker, always use an all current sensitive leakage breaker, RCM or RCD Type B (according to IEC/EN 60755) with a sufficient trip level.

Currents and fuses

IEC approval

Compressor type	V	I _{max} (1) A	Max fuse (1)	I _{max} (2) A	Max fuse (2)
			gL/gG A		gL/gG A
GA 18 VSD+	200	88.1	100	94.2	100
GA 18 VSD+	230	88.9	100	94.9	100
GA 18 VSD+	380	44.5	50	49.1	50
GA 18 VSD+	400	44.1	50	48.6	50
GA 18 VSD+	400+N	44.1	50	48.6	50
GA 18 VSD+	460	44.4	50	49	50
GA 18 VSD+	500	35.2	40	37.2	40

Compressor type	V	I _{max} (1) A	Max fuse (1)	I _{max} (2) A	Max fuse (2)
			gL/gG A		gL/gG A
GA 22 VSD+	200	118.1	125	124.3	125
GA 22 VSD+	230	118.7	125	125	125
GA 22 VSD+	380	59.5	63	64.2	80
GA 22 VSD+	400	59	63	63.7	80

Compressor type		I_{max} (1)	Max fuse (1)	I_{max} (2)	Max fuse (2)
		V	A	A	A
			gL/gG		gL/gG
GA 22 VSD+	400+N	59	63	63.7	80
GA 22 VSD+	460	59.4	63	64.1	80
GA 22 VSD+	500	47.2	50	49.7	50

Compressor type		I_{max} (1)	Max fuse (1)	I_{max} (2)	Max fuse (2)
		V	A	A	A
			gL/gG		gL/gG
GA 26 VSD+	200	118.8	125	125.1	125
GA 26 VSD+	230	118.7	125	125	125
GA 26 VSD+	380	59.5	63	64.2	80
GA 26 VSD+	400	59.4	63	64.1	80
GA 26 VSD+	400 + N	59.4	63	64.1	80
GA 26 VSD+	460	59.4	63	64.1	80
GA 26 VSD+	500	47.5	50	50	50

Compressor type		I_{max} (1)	Max fuse (1)	I_{max} (2)	Max fuse (2)
		V	A	A	A
			gL/gG		gL/gG
GA 30 VSD+	200	144.9	160	152.5	160
GA 30 VSD+	230	144.8	160	152.4	160
GA 30 VSD+	380	72.5	80	78.2	80
GA 30 VSD+	400	72.5	80	78.2	80
GA 30 VSD+	400 + N	72.5	80	78.2	80
GA 30 VSD+	460	72.4	80	78.1	80
GA 30 VSD+	500	57.9	63	60.9	63

Compressor type		I_{max} (1)	Max fuse (1)	I_{max} (2)	Max fuse (2)
		V	A	A	A
			gL/gG		gL/gG
GA 37 VSD+	200	174.5	200	183.1	200
GA 37 VSD+	230	174.5	200	183.1	200
GA 37 VSD+	380	87.7	100	93.4	100
GA 37 VSD+	400	87.7	100	93.4	100
GA 37 VSD+	400 + N	87.7	100	93.4	100
GA 37 VSD+	460	87.7	100	93.4	100
GA 37 VSD+	500	70.2	80	73.2	100

UL/cUL approval

Compressor type		I_{max} (1)	Max fuse (1)	I_{max} (2)	Max fuse (2)
			K5/ HRC form II		K5/ HRC form II
	V	A	A	A	A
GA 18 VSD+	200	88.1	90	94.2	100
GA 18 VSD+	230	88.9	90	94.9	100
GA 18 VSD+	460	44.4	50	49	50
GA 18 VSD+	575	35.5	40	37.9	40

Compressor type		I_{max} (1)	Max fuse (1)	I_{max} (2)	Max fuse (2)
			K5/ HRC form II		K5/ HRC form II
	V	A	A	A	A
GA 22 VSD+	200	118.1	125	124.3	125
GA 22 VSD+	230	118.7	125	125	125
GA 22 VSD+	460	59.4	60	64.1	70
GA 22 VSD+	575	47.5	50	50	50

Compressor type		I_{max} (1)	Max fuse (1)	I_{max} (2)	Max fuse (2)
			K5/ HRC form II		K5/ HRC form II
	V	A	A	A	A
GA 26 VSD+	200	118.8	125	125.1	125
GA 26 VSD+	230	118.7	125	125	125
GA 26 VSD+	460	59.4	60	64.1	70
GA 26 VSD+	575	47.5	50	50	50

Compressor type		I_{max} (1)	Max fuse (1)	I_{max} (2)	Max fuse (2)
			K5/ HRC form II		K5/ HRC form II
	V	A	A	A	A
GA 30 VSD+	200	144.9	175	152.5	175
GA 30 VSD+	230	144.8	175	152.4	175
GA 30 VSD+	460	72.4	80	78.1	80
GA 30 VSD+	575	57.9	70	60.9	70

Compressor type		I_{max} (1)	Max fuse (1)	I_{max} (2)	Max fuse (2)
			K5/ HRC form II		K5/ HRC form II
	V	A	A	A	A
GA 37 VSD+	200	175.4	175	183.1	200
GA 37 VSD+	230	175.4	175	183.1	200
GA 37 VSD+	460	87.7	90	93.4	100
GA 37 VSD+	575	70.2	70	73.2	80

I: current in the supply lines at maximum load and nominal voltage

(1): compressors without integrated dryer

(2): compressors with integrated dryer

Setting for circuit breakers

Q1	1 A
Q15	0.5 A

Fuse calculations for IEC are done according to 60364-4-43 electrical installations of buildings, part 4: protection for safety- section 43: protection against overcurrent. Fuse sizes are calculated in order to protect the cable against short circuit.

Fuse calculations for cUL and UL: The indicated fuse size is the maximum fuse size in order to protect the motor against short circuit. For cUL fuse HRC form II, for UL fuse class K5

Earthing

The earthing cable connected to the compressor (PE) should be minimum 10 mm² (according to EN 60204-1 section 828).

Cable sizing according IEC

The tables below indicate the current carrying capacities of cables for 3 commonly used installation methods, calculated according to standard 60364-5-52 - electrical installations of buildings part 5 - selection and erection equipment and section 52 - current carrying capacities in wiring systems.

The allowed currents are valid for PVC insulated cables with three loaded copper conductors (maximum conductor temperature 70 °C).

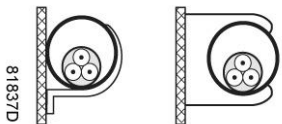
	<p>Installation method B2 according table B.52.1. Multi-core cable in conduit on a wooden wall</p>
---	--

Maximum allowed current in function of the ambient temperature for installation method B2

Cable section	Ambient temperature				
	30 °C	40 °C	45 °C	50 °C	55 °C
4 mm ²	< 27 A	< 23 A	< 21 A	< 19 A	< 16 A

Cable section	Ambient temperature				
	30 °C	40 °C	45 °C	50 °C	55 °C
6 mm ²	< 34 A	< 30 A	< 27 A	< 24 A	< 21 A
10 mm ²	< 46 A	< 40 A	< 36 A	< 33 A	< 28 A
16 mm ²	< 62 A	< 54 A	< 49 A	< 44 A	< 38 A
25 mm ²	< 80 A	< 70 A	< 63 A	< 57 A	< 49 A
35 mm ²	< 99 A	< 86 A	< 78 A	< 70 A	< 60 A
50 mm ²	< 118 A	< 103 A	< 93 A	< 84 A	< 72 A
70 mm ²	< 149 A	< 130 A	< 118 A	< 106 A	< 91 A
95 mm ²	< 179 A	< 156 A	< 141 A	< 127 A	< 109 A
120 mm ²	< 206 A	< 179 A	< 163 A	< 146 A	< 126 A

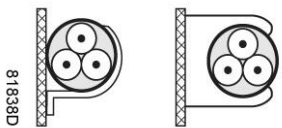

Installation method C according table B.52.1.
Single-core or multi-core cable on a wooden wall

Maximum allowed current in function of the ambient temperature for installation method C

Cable section	Ambient temperature				
	30 °C	40 °C	45 °C	50 °C	55 °C
4 mm ²	< 32 A	< 28 A	< 25 A	< 23 A	< 20 A
6 mm ²	< 41 A	< 36 A	< 32 A	< 29 A	< 25 A
10 mm ²	< 57 A	< 50 A	< 45 A	< 40 A	< 35 A
16 mm ²	< 76 A	< 66 A	< 60 A	< 54 A	< 46 A
25 mm ²	< 96 A	< 84 A	< 76 A	< 68 A	< 59 A
35 mm ²	< 119 A	< 104 A	< 94 A	< 84 A	< 73 A
50 mm ²	< 144 A	< 125 A	< 114 A	< 102 A	< 88 A
70 mm ²	< 184 A	< 160 A	< 145 A	< 131 A	< 112 A
95 mm ²	< 223 A	< 194 A	< 176 A	< 158 A	< 136 A
120 mm ²	< 259 A	< 225 A	< 205 A	< 184 A	< 158 A

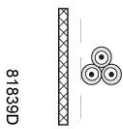

Installation method F according table B.52.1.
Single-core cables, touching in free air
Clearance to wall not less than one cable diameter

Maximum allowed current in function of the ambient temperature for installation method F

Cable section	Ambient temperature				
	30 °C	40 °C	45 °C	50 °C	55 °C
25 mm ²	< 110 A	< 96 A	< 87 A	< 78 A	< 67 A
35 mm ²	< 137 A	< 119 A	< 108 A	< 97 A	< 84 A

Cable section	Ambient temperature				
	30 °C	40 °C	45 °C	50 °C	55 °C
50 mm ²	< 167 A	< 145 A	< 132 A	< 119 A	< 102 A
70 mm ²	< 216 A	< 188 A	< 171 A	< 153 A	< 132 A
95 mm ²	< 264 A	< 230 A	< 209 A	< 187 A	< 161 A
120 mm ²	< 308 A	< 268 A	< 243 A	< 219 A	< 188 A

Calculation method for IEC:

- Single supply cables (3 phases + PE - configuration (1)):
 - Add 10 % to the total compressor current ($I_{tot}Pack$ or $I_{tot}FF$ from the tables)
 - Install the prescribed fuse on each cable
- Parallel supply cable (2 x 3 phases + PE - configuration (2)):
 - Add 10 % to the total compressor current ($I_{tot}Pack$ or $I_{tot}FF$ from the tables) and divide by 2
 - Multiply the ampacity of the cables with 0.8 (see table A.52.17 (52-E1))
 - Install fuses of half the size of the recommended maximum fuse size on each cable.
- When using 2 x 3 phases + PE as in (3):
 - Add 10 % to the total compressor current ($I_{tot}Pack$ or $I_{tot}FF$ from the tables) and divide by $\sqrt{3}$
 - Multiply the ampacity of the cables with 0.8 (see table A.52.17 (52-E1))
 - Fuse size: the recommended maximum fuse size divided by $\sqrt{3}$ on each cable.
- Size of the PE cable:
 - For supply cables up to 35 mm²: same size as supply cables
 - For supply cables larger than 35 mm²: half the size of the supply wires

Always check the voltage drop over the cable (less than 5 % of the nominal voltage is recommended).

Example: $I_{tot} = 89$ A, maximum ambient temperature is 45 °C, recommended fuse = 100 A

- Single supply cables (3 phases + PE - configuration (1)):
 - $I = 89 \text{ A} + 10 \% = 89 \times 1.1 = 97.9 \text{ A}$
 - The table for B2 and ambient temperature = 45 °C allows a maximum current of 93 A for a 50 mm² cable. For a cable of 70 mm², the maximum allowed current is 118 A, which is sufficient. Therefore, use a 3 x 70 mm² + 35 mm² cable.
If method C is used, 50 mm² is sufficient. (35 mm² for method F) => cable 3 x 50 mm² + 25 mm².
- Parallel supply cable (2 x 3 phases + PE - configuration (2)):
 - $I = (89 \text{ A} + 10 \%)/2 = (89 \times 1.1)/2 = 49 \text{ A}$
 - For a cable of 25 mm², B2 at 45 °C, the maximum current is 63 A x 0.8 = 50.4 A. So 2 parallel cables of 3 x 25 mm² + 25 mm² are sufficient.
 - Install 50 A fuses on each cable instead of 100 A.

Cable sizing according UL/cUL

Calculation method according UL 508A, table 28.1 column 5: allowable ampacities of insulated copper conductors (75 °C (167 °F)).

Maximum allowed current in function of the wire size

AWG or kcmil	Maximum current
10	< 30 A
8	< 50 A
6	< 65 A
4	< 85 A

AWG or kcmil	Maximum current
3	< 100 A
2	< 115 A
1	< 130 A
1/0	< 150 A
2/0	< 175 A
3/0	< 200 A

Calculation method for UL:

- Single supply cables (3 phases + 1 PE - configuration (1)):
 - Add 25 % to the total current from the tables (see UL 508A 28.3.2: "Ampacity shall have 125 % of the full load current")
 - Install the prescribed maximum fuse on each cable
- Parallel supply cable (2 x 3 phases + 2 PE - configuration (2)):
 - Add 25 % to the total current from the tables and divide by 2
 - Multiply the ampacity of the cables with 0.8 (see UL 508A table 28.1 continued)
 - Install fuses of half the size of the recommended maximum fuse size on each cable.
- When using 2 x 3 phase + 2 PE as in (3):
 - Add 25 % to the total current from the tables and divide by $\sqrt{3}$
 - Multiply the ampacity of the cables with 0.8 (see UL 508A table 28.1 continued)
 - Fuse size: the recommended maximum fuse size divided by $\sqrt{3}$ on each cable.
- Size PE cable:
 - For supply cables up to AWG8: same size as the supply cables
 - For supply cables larger than AWG8: use maximum allowed ampacity of the selected supply cables and compare with value in table below (see CEC Part 1 table 17)

< 100 A: use AWG8
< 200 A: use AWG6
< 300 A: use AWG4

Always check the voltage drop over the cable (less than 5 % of the nominal voltage is recommended).

Example of supply cable calculation: $I_{tot} = 128$ A, maximum ambient temperature is 45 °C, recommended fuse = 150 A

- Single supply cables (3 phases + 1 PE - configuration (1)):
 - $I = 128$ A + 25 % = $128 \times 1.25 = 160$ A
 - For AWG2/0, the maximum current is 175 A, which is sufficient => use AWG2/0
 - Install the prescribed maximum fuse (150 A) on each cable
- Parallel supply cable (2 x 3 phases + 2 PE - configuration (2)):
 - $I = (128$ A + 25%)/2 = $(128 \times 1.25)/2 = 80$ A
 - For a AWG4, the maximum current is 85 A x 0.8 = 68 A, which is insufficient. For an AWG3, the maximum current is 100 x 0.8 = 80 A. So 2 parallel cables of 3 x AWG3 + 2 x AWG8 are sufficient.
 - Install 80 A fuses on each cable.

8.3 Reference conditions and limitations

Reference conditions

Air inlet pressure (absolute)	bar	1
Air inlet pressure (absolute)	psi	14.5
Air inlet temperature	°C	20
Air inlet temperature	°F	68
Relative humidity	%	0
Working pressure		See section Compressor data.

Limitations

Maximum working pressure		See section Compressor data.
Minimum working pressure	bar(e)	4
Minimum working pressure	psig	58
Maximum air inlet temperature	°C	46
Maximum air inlet temperature	°F	115
Minimum ambient temperature	°C	1
Minimum ambient temperature	°F	34

8.4 Compressor data

Reference conditions

	All data specified below apply under reference conditions, see section Reference conditions and limitations .
---	---

Common compressor data

	Unit	
Number of compression stages		1
Temperature of the air leaving the outlet valve (approx.), Workplace	°C	30
Temperature of the air leaving the outlet valve (approx.), Workplace	°F	86
Temperature of the air leaving the outlet valve (approx.), Workplace Full-Feature	°C	30
Temperature of the air leaving the outlet valve (approx.), Workplace Full-Feature	°F	86
Refrigerant type, Workplace Full-Feature		R410a

GA 18 VSD+

Normal effective working pressure	bar(e)	4	7	9.5	12.5
-----------------------------------	--------	---	---	-----	------

Normal effective working pressure	psig	58	102	138	181
Maximum effective working pressure, Workplace	bar(e)	13	13	13	13
Maximum effective working pressure, Workplace	psig	189	189	189	189
Maximum effective working pressure, Workplace Full-Feature	bar(e)	12.75	12.75	12.75	12.75
Maximum effective working pressure, Workplace Full-Feature	psig	185	185	185	185
Maximum motor shaft speed	rpm	4800	4800	4100	3500
Minimum motor shaft speed	rpm	1300	1300	1400	1500

Nominal motor power	kW	18
Nominal motor power	hp	24.1
Total amount of refrigerant, Workplace Full-Feature	kg	0.95
Total amount of refrigerant, Workplace Full-Feature	lb	2.09
Oil capacity	l	14.1
Oil capacity	US gal	3.72
Oil capacity	Imp. gal	3.1
Oil capacity	cu. ft.	0.50
Sound pressure level (according to ISO 2151 (2004))	dB(A)	64

GA 22 VSD+

Normal effective working pressure	bar(e)	4	7	9.5	12.5
Normal effective working pressure	psig	58	102	138	181
Maximum effective working pressure, Workplace	bar(e)	13	13	13	13
Maximum effective working pressure, Workplace	psig	189	189	189	189
Maximum effective working pressure, Workplace Full-Feature	bar(e)	12.75	12.75	12.75	12.75
Maximum effective working pressure, Workplace Full-Feature	psig	185	185	185	185
Maximum motor shaft speed	rpm	5700	5700	5000	4200
Minimum motor shaft speed	rpm	1300	1300	1400	1500

Nominal motor power	kW	22
Nominal motor power	hp	29.5
Total amount of refrigerant, Workplace Full-Feature	kg	0.95
Total amount of refrigerant, Workplace Full-Feature	lb	2.09
Oil capacity	l	14.7
Oil capacity	US gal	3.88
Oil capacity	Imp. gal	3.23

Oil capacity	cu. ft.	0.52
Sound pressure level (according to ISO 2151 (2004))	dB(A)	67

GA 26 VSD+

Normal effective working pressure	bar(e)	4	7	9.5	12.5
Normal effective working pressure	psig	58	102	138	181
Maximum effective working pressure, Workplace	bar(e)	13	13	13	13
Maximum effective working pressure, Workplace	psig	189	189	189	189
Maximum effective working pressure, Workplace Full-Feature	bar(e)	12.75	12.75	12.75	12.75
Maximum effective working pressure, Workplace Full-Feature	psig	185	185	185	185
Maximum motor shaft speed	rpm	6500	6500	5800	5000
Minimum motor shaft speed	rpm	1300	1300	1400	1500

Nominal motor power	kW	26
Nominal motor power	hp	34.9
Total amount of refrigerant, Workplace Full-Feature	kg	1.1
Total amount of refrigerant, Workplace Full-Feature	lb	2.43
Oil capacity	l	15.5
Oil capacity	US gal	4.09
Oil capacity	Imp. gal	3.41
Oil capacity	cu. ft.	0.55
Sound pressure level (according to ISO 2151 (2004))	dB(A)	67

GA 30 VSD+

Normal effective working pressure	bar(e)	4	7	9.5	12.5
Normal effective working pressure	psig	58	102	138	181
Maximum effective working pressure, Workplace	bar(e)	13	13	13	13
Maximum effective working pressure, Workplace	psig	189	189	189	189
Maximum effective working pressure, Workplace Full-Feature	bar(e)	12.75	12.75	12.75	12.75
Maximum effective working pressure, Workplace Full-Feature	psig	185	185	185	185
Maximum motor shaft speed	rpm	7400	7400	6500	5500
Minimum motor shaft speed	rpm	1300	1300	1400	1500

Nominal motor power	kW	30
---------------------	----	----

Nominal motor power	hp	40.2
Total amount of refrigerant, Workplace Full-Feature	kg	1.1
Total amount of refrigerant, Workplace Full-Feature	lb	2.43
Oil capacity	l	16
Oil capacity	US gal	4.23
Oil capacity	Imp. gal	3.52
Oil capacity	cu. ft.	0.57
Sound pressure level (according to ISO 2151 (2004))	dB(A)	67

GA 37 VSD+

Normal effective working pressure	bar(e)	4	7	9.5	12.5
Normal effective working pressure	psig	58	102	138	181
Maximum effective working pressure, Workplace	bar(e)	13	13	13	13
Maximum effective working pressure, Workplace	psig	189	189	189	189
Maximum effective working pressure, Workplace Full-Feature	bar(e)	12.75	12.75	12.75	12.75
Maximum effective working pressure, Workplace Full-Feature	psig	185	185	185	185
Maximum motor shaft speed	rpm	9000	9000	8000	6800
Minimum motor shaft speed	rpm	1300	1300	1400	1500

Nominal motor power	kW	37
Nominal motor power	hp	49.6
Total amount of refrigerant, Workplace Full-Feature	kg	1.1
Total amount of refrigerant, Workplace Full-Feature	lb	2.43
Oil capacity	l	16
Oil capacity	US gal	4.23
Oil capacity	Imp. gal	3.52
Oil capacity	cu. ft.	0.57
Sound pressure level (according to ISO 2151 (2004))	dB(A)	67

8.5 Technical data Elektronikon® controller

General

Supply voltage	24 V AC /16 VA 50/60Hz (+40%/-30%) 24 V DC/0.7 A
Type of protection	IP54 (front) IP21 (back)

Ambient and temperature conditions	IEC60068-2
<ul style="list-style-type: none"> Operating temperature range Storage temperature range 	<ul style="list-style-type: none"> -10°C.....+60°C (14 °F140 °F) -30°C.....+70°C (-22 °F158 °F)
Permissible humidity	Relative humidity 90% No condensation
Noise emission	IEC61000-6-3
Noise immunity	IEC61000-6-2
Mounting	Cabinet door

Digital outputs

Number of outputs	9 (Elektronikon® Graphic controller - p.n. 1900 5200 10 1900 5200 19)
Type	Relay (voltage free contacts)
Rated voltage AC	250 V AC / 10 A max.
Rated voltage DC	30 V DC / 10 A max.

Digital inputs

Number of inputs	10 (Elektronikon® Graphic controller - p.n. 1900 5200 10 1900 5200 19)
Supply by controller	24 V DC
Supply protection	Short circuit protected to ground
Input protection	Not isolated

Analog inputs

Number of pressure inputs	2 (Elektronikon® Graphic controller - p.n. 1900 5200 10 1900 5200 19)
Number of temperature inputs	5 (Elektronikon® Graphic controller - p.n. 1900 5200 10 1900 5200 19)

9 Instructions for use

Air/oil separator vessel

-	This vessel can contain pressurised air; this can be potentially dangerous if the equipment is misused.
-	This vessel must only be used as a compressed air/oil separator and must be operated within the limits specified on the data plate.
-	No alterations must be made to this vessel by welding, drilling or any other mechanical methods without the written permission of the manufacturer.
-	The safety valve must correspond with pressure surges of 1.1 times the maximum allowable operating pressure. It should guarantee that the pressure will not permanently exceed the maximum allowable operating pressure of the vessel.
-	Use only oil as specified by the manufacturer.
-	This vessel has been designed and built to guarantee an operational lifetime in excess of 20 years. The vessel needs a yearly visual inspection. National legislation may require in service inspection.

10 Guidelines for inspection

Guidelines

On the Declaration of Conformity / Declaration by the Manufacturer, the harmonised and/or other standards that have been used for the design are shown and/or referred to.

The Declaration of Conformity / Declaration by the Manufacturer is part of the documentation that is supplied with this compressor.

Local legal requirements and/or use outside the limits and/or conditions as specified by the manufacturer may require other inspection periods as mentioned below.

11 Pressure equipment directives

Components subject to 97/23/EC Pressure Equipment Directive

The following table contains the necessary information for the inspection of all pressure equipment of category II and higher according to the Pressure Equipment Directive 97/23/EC and all pressure equipment according to the Simple Pressure Vessel Directive 2009/105/EC.

Compressor type	Component	Description	Volume	Design pressure	Minimum and maximum design temperature	PED Class
GA 18 VSD+ up to GA 37 VSD+	1625 4815 01	Vessel	29 l	15 bar(e)	-8 °C/ 120 °C	-
	0830 1010 03	Safety valve	-	-	-	IV
	0830 1009 98	Safety valve	-	-	-	IV

Compressor type	Component	Description	Number of cycles (1)	Minimum wall thickness	Visual inspection frequency (2)	Hydrostatic inspection frequency (2)
GA 18 VSD+ and GA 37 VSD+	1625 4815 01	Vessel	2 x 10 ⁶	2 mm	1 year	10 years
	0830 1010 03	Safety valve	-	-	-	-
	0830 1009 98	Safety valve	-	-	-	-

The compressors conform to PED smaller than category II.

(1) The number of cycles refers to the number of cycles from 0 bar(e) to maximum pressure.

(2) Other inspection techniques such as ultrasonic or X-ray are equivalent to hydrostatic testing for this equipment.

12 Declaration of conformity

EC DECLARATION OF CONFORMITY

- 1
- 2 We, ⁽¹⁾ declare under our sole responsibility, that the product
- 3 Machine name
- 4 Machine type
- 5 Serial number
- 6 Which falls under the provisions of article 12.2 of the EC Directive 2006/42/EC on the approximation of the laws of the Member States relating to machinery, is in conformity with the relevant Essential Health and Safety Requirements of this directive.

The machinery complies also with the requirements of the following directives and their amendments as indicated.

7	Directive on the approximation of laws of the Member States relating to	Harmonized and/or Technical Standards used	Att' mnt
a.	Pressure equipment	97/23/EC	
b.	Machinery safety	2006/42/EC	EN ISO 12100 – 1 EN ISO 12100 – 2 EN 1012 – 1
c.	Simple pressure vessel	2009/105/EC	
d.	Electromagnetic compatibility	2004/108/EC	EN 61000-6-2 EN 61000-6-4
e.	Low voltage equipment	2006/95/EC	EN 60034 EN 60204-1 EN 60439
f.	Outdoor noise emission	2000/14/EC	
g.	Equipment and protective systems in potentially explosive atmospheres	94/9/EC	
h.	Medical devices General	93/42/EEC	EN ISO 13845 EN ISO 14971 EN 737-3
i.			

8.a The harmonized and the technical standards used are identified in the attachments hereafter

8.b (Product company) is authorized to compile the technical file.

9		Conformity of the specification to the directives	Conformity of the product to the specification and by implication to the directives
10			

11	Issued by	Product engineering	Manufacturing
12			
13			
14	Name		

15 Signature

16 Date

Typical example of a Declaration of Conformity document

(1): Contact address:

Atlas Copco Airpower n.v.

P.O. Box 100

B-2610 Wilrijk (Antwerp)

Belgium

81679D

On the Declaration of Conformity / Declaration by the Manufacturer, the harmonised and/or other standards that have been used for the design are shown and/or referred to.

The Declaration of Conformity / Declaration by the Manufacturer is part of the documentation that is supplied with this device.

In order to be First in Mind—First in Choice® for all your quality compressed air needs, Atlas Copco delivers the products and services that help to increase your business' efficiency and profitability.

Atlas Copco's pursuit of innovation never ceases, driven by our need for reliability and efficiency. Always working with you, we are committed to providing you the customized quality air solution that is the driving force behind your business.

