

Ai Extreme Rage

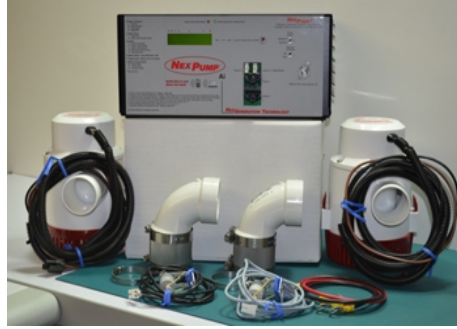

Standard Features

- Self Testing every 12 hours: Components checked and pumps exercised for proper operation
- Dual Sensors: Redundancy. High water alert system only with NexPump.
- Advanced Real-time Diagnostics: Logic detects plumbing problems, sensor errors, and more...
- Dual Batteries: Will support dual battery connection for twice the running time
- Displayed Full Text Error Messages: Built for easy diagnosing
- Pump Hour tracking/stats: Only NexPump tells you how long your pumps have run
- Plumbing Error Detection: Detects Vapor Locks, Clogs
- Operates on Electricity: Or Battery when electricity fails
- High-Tech Battery Life Monitoring System: Let's you know battery life in hours during power failures
- User Friendly LCD Display: Easy to Read to know status at a glance
- Comprehensive Menu: Easy to Use Menu System to change system features
- Audible Alarm: Let's you know issues with an alarm over 100db
- Advanced Logic Design: Built in features only available on the NexPump
- Advanced Microprocessor controlled: High-Tech microprocessor with advanced computer code

Optional Features

- Notification Modules: Phone Line Connection, Wired Internet Connection, Wireless Internet Connection
- 24/7 Notification System: Receive phone calls, email or text alerts to let you know of possible failures or alerts
- 24/7 Internet Connectivity: Status, Battery Life, Commands, Configuration from any Computer or Smartphone
- 24/7 Monitoring: Vacationing or working, NexPump will keep you informed

Model Features

- Dual Pump: Typical discharge rate of **107 GPM at 10 Feet** (with Quiet Check Valve Installed)
- 20-amp Battery Charger: Smart Multi-Stage, AGM compatible
- Limited 3 Year Warranty: Better than Industry Standard
- Recommend Backup System: Use with another primary pump

Available Models

Ai Rage (*without notification*)

Ai Rage-AN (*Notification for Phone line*)

Ai Rage-ANi (*Notification for Wired Internet Connection*)

Ai Rage-ANiw (*Notification for Wireless Internet Connection*)

Discharge Rates

Extreme Series System Discharge Rates at 10 Feet Head

| | |
|---------------------------|----------------|
| Ai Rage (Open Flow) | 6840 (114 GPM) |
| Ai Rage (w/Check Valves) | 6420 (107 GPM) |
| Ai Turbo (Open Flow) | 5580 (93 GPM) |
| Ai Turbo (w/Check Valves) | 5160 (86 GPM) |
| Ai Jet (Open Flow) | 3420 (57 GPM) |
| Ai Jet (w/Check Valves) | 3240 (54 GPM) |

Standard Series System Discharge Rates at 10 Feet Head

| | |
|----------------------------|---------------|
| Ai Dual (Open Flow) | 4320 (72 GPM) |
| Ai Dual (w/Check Valves) | 3960 (66 GPM) |
| Ai Single (Open Flow) | 2160 (36 GPM) |
| Ai Single (w/Check Valves) | 1980 (33 GPM) |

Other Information

| | |
|---------------------------------------|-------------------------------------------------------|
| Made in USA: | Yes |
| Pump Housing : | ABS |
| Float Type: | Stem w/Internal Electronics (Rated 50 Million Cycles) |
| Power Cord Length: | 6 Ft. |
| Thermal Protection: | Yes, Controller Monitored |
| Oil-Free Motor: | Yes |
| Solid Handling: | No |
| Manual Override: | Yes, 100% Manual Override |
| Built-in Check Valve: | No |
| Discharge Port Size: | 1-1/2" |
| Sump Basin Size: | *Standard 18" |
| Motor Amps: | High Capacity 16 Amps DC Ultra Capacity 22 Amps DC |
| Float On/Off or Pumping Differential: | Electronic Virtual Pump Sensing |

Discharge Graphs

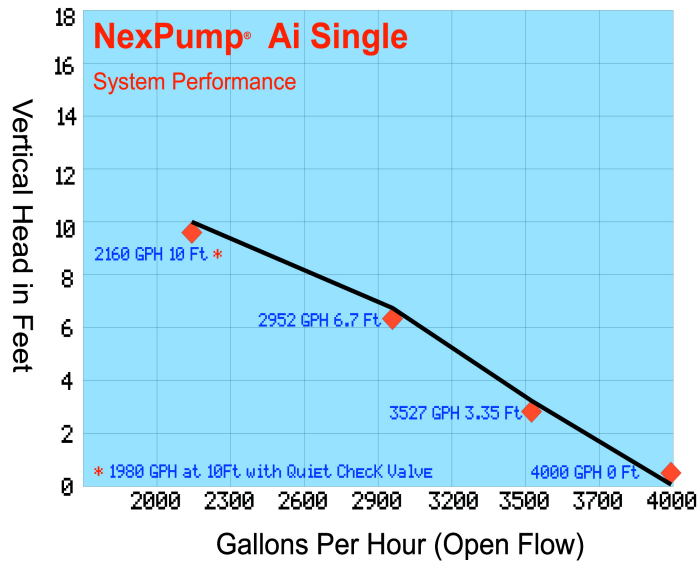
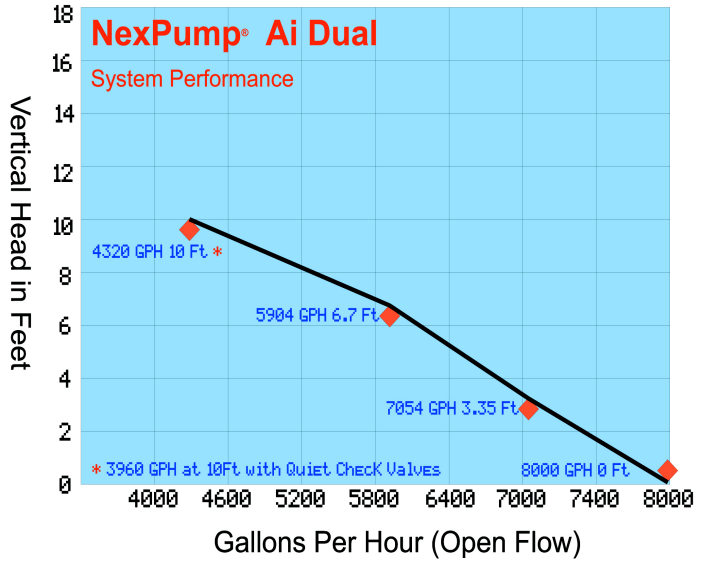
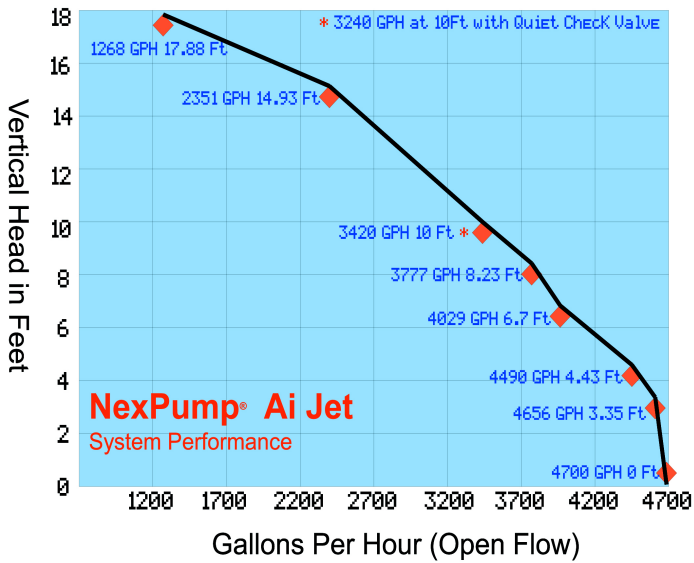
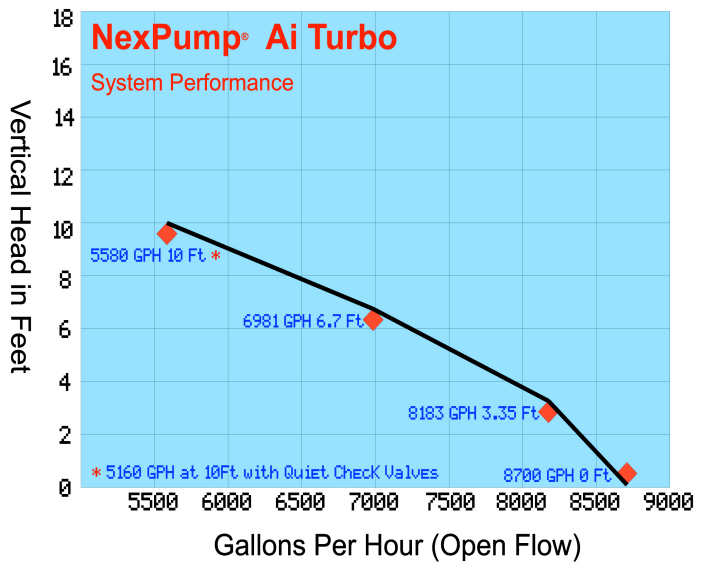
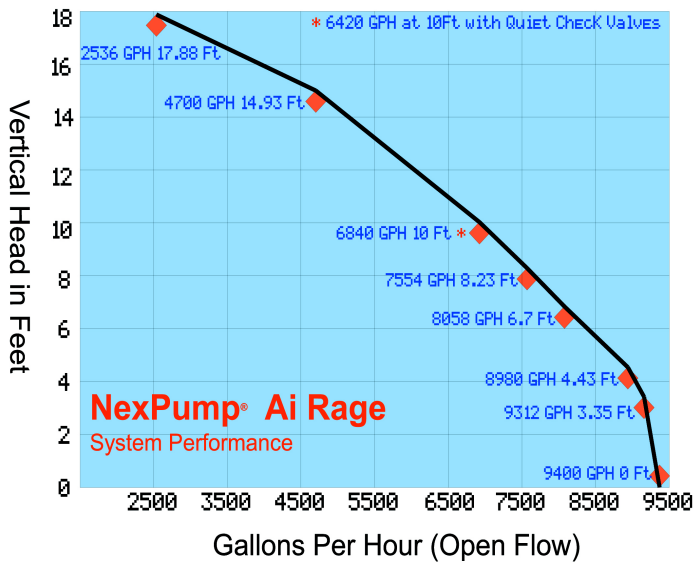

Notification System

The "Ai Notification System" is the ONLY Sump Pump in the World with not only a totally integrated Notification System but also a total comprehensive coupled Notification System. Totally integrated and comprehensive means it's sole purpose is to couple to the "NexPump Advanced Diagnostics" and relay information to you via Phone Calls and E-Mails, Text Messages, so you can always have the "Peace of Mind" that you are going to stay dry. The "Ai Notification System" can relay Thirty Eight (38) critical points that are monitored by the "NexPump Advanced Logic".

From AC Power Loss, Sensor, Pump, Battery or Internal Electronics Issues you will be informed. But it doesn't end with just a Notification. The "NexPump Advanced Logic", hence the name "Ai" (Artificial Intelligence) is always operating and making Millions of decisions per second. Sensor Issues, we have built in logic to automatically enter our exclusive "Emergency Mode" to operate Pumps as needed. If there is water to Pump out, your NexPump will Pump it out. No water, the Pumps will just turn on then off, as the "NexPump Advanced Logic" is able to detect water from the Pumps themselves. Internal Electronic Issues, we have "Backup Electronics" to take over automatically to ensure your NexPump is still able to operate. We can operate indefinitely in the "Emergency Mode" or under the "Backup Electronics". Best of all, we make you aware of any issue, so we can take care of any problems, with the best support ever offered. One Note, if you have a Model without the "Ai Notification System" you will still be informed of any alerts via the NexPumps built in alarm.

The "Ai Notification System" is available in three (3) options for it's communication medium. One option is the "Phone Line Module" that uses a Standard Phone Line. Another option is the "Wired Internet Module", this Module uses your existing Internet Router or Hub. The last available option is the "Wireless Internet Module" that also uses your existing Internet Connection through a Wireless Router. Any of these options will allow the "Ai Notification System" to relay any alerts to you via Phone Calls and E-Mails, Text Messages. Both "NexPump Internet Modules" will also allow you remote connections to check status, configuration and more.

Want more good news, there are **NO RECURRING** fees for the Notification System. Once you purchase the "**Ai Notification System**" you won't have to worry about paying an annual fee or ANY FEE. All NexPump Models are available with the Notification Option. Models with a suffix of "-AN" are for Phone Line, "-ANi" are "Wired Internet Models" and "ANiw" are "Wireless Internet Models". The "**Ai Notification System**" once registered will allow you to enter two (2) Phone Numbers and up to four (4) E-Mail Addresses. These numbers or addresses can be changed anytime just with access to the Internet on the NexPump Website. You can also use the E-Mail Addresses to add your contractors so they are on the alert list.

Internet Screens Examples



[Status](#) | [Web Configuration](#) | [Command Console](#)

NexPump Stats and Informational Page (SN:'NPB01000100')

| | | | | | |
|--------------------------------|--|--------------------|-------------------------------|--|----------------------------------|
| Pump 1: | | Status: OK | Pump 2: | | Status: OK |
| Stats: 15 Hours (0), Type: 'U' | | | Stats: 2 Hours (0), Type: 'U' | | |
| Sensor 1: | | Status: Connected | Sensor 2: | | Status: Connected |
| Electricity: | | Status: OK | Battery: AGM 240 A/H | | Status:OK (Replace in 1547 Days) |
| Charger: | | Status: Charge Off | Case Fan: | | Status: OK |
| VRef: | | Status: OK | EEProm: | | Status: OK |
| Alarm: | | Status: Enabled | Operating Mode: | | Mode:Primary |
| LAN Monitor: | | Status: ON | Link: | | Status: Connected |
| IP Config: | | Status: Unlocked | Update Mode: | | Status: ON |



[Status](#) | [Web Configuration](#) | [Command Console](#)

NexPump Command Console Page (SN:'NPB01000100')

Command:

Command Value:

Command Status: Ready!

Command Last Error: None

*Some commands are available only under certain conditions and may not always be listed!

*This NexPump is in the Demo Mode. Some features may be disabled when operating in this mode!

[NexPump Website](#)

Copyright © 2003-2012, NexPump Inc.

Web Image V4.04.0011

Installation Diagrams

Dual NexPump (Ai Rage, Ai Turbo, Ai Dual) as Backup Pump

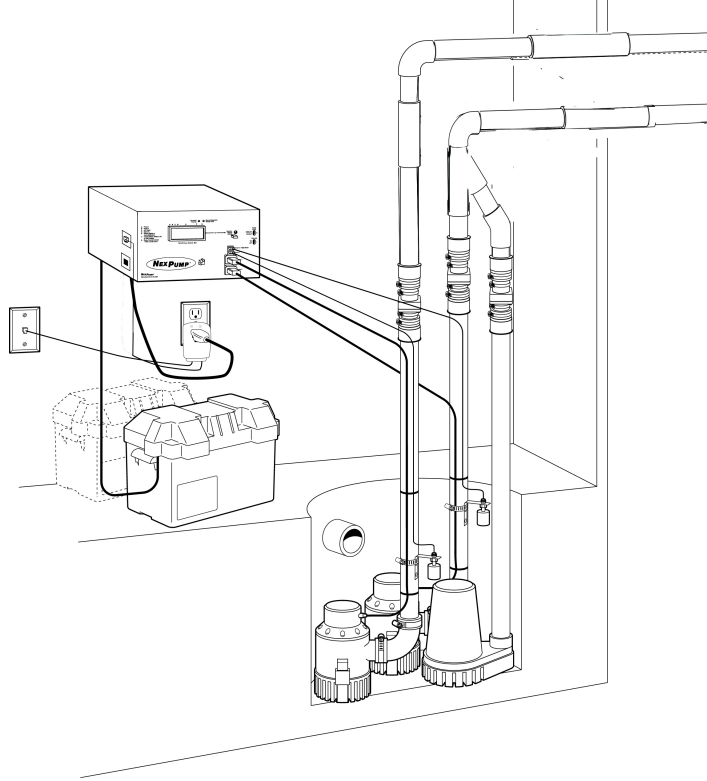

Dual NexPump (Ai Turbo, Ai Dual) as Primary Pump

