

Job Name/Location:

Tag No:

Date:

For:	File	Resubmit
	Approval	Other_____

PO No.:

Architect:

GC:

Engr:

Mech:

Rep:

(Company)

(Project Manager)

## LMCN078HV

Multi F Ceiling Cassette Indoor Unit  
7,000 Btu/h



### Performance:

Nominal Cooling Capacity (Btu/h)	7,000
Nominal Heating Capacity (Btu/h)	8,100

Cooling Nominal Test Conditions:

Indoor: 80°F DB / 67°F WB  
Outdoor: 95°F DB / 75°F WB

Heating Nominal Test Conditions:

Indoor: 70°F DB / 60°F WB  
Outdoor: 47°F DB / 43°F WB

### Electrical:

Power Supply (V/Hz/Ø)	208-230/60/1
Rated Amps (A)	0.25

### Piping:

Installed Liquid Pipe (in., O.D.)	Ø1/4
Installed Vapor Pipe (in., O.D.)	Ø3/8
Liquid Connection (in., O.D.)	Ø1/4
Vapor Connection (in., O.D.)	Ø3/8
Drain (in., O.D. / I.D.)	1-1/4, 1
Temperature Sensor	Thermistor

### Controls Features:

- Two thermistor control
- 24-Hour on / off timer
- Auto operation
- Auto restart
- Chaos swing
- Control lock function
- Drain pump
- Group control
- Inverter (variable speed fan)
- Jet cool
- Compatible with accessory Wi-Fi module

### Included Accessories:

- Wireless Remote Controller — AKB73757604 (Also referenced by Model No. PQWRHQ0FDB)

### Required Accessories:

- Grille Kit (24-13/32" x 24-13/32") - PT-QAGWO

### Optional Accessories:

- MultiSITE™ CRC1 Controller - PREMTBVC2
- MultiSITE™ CRC1+ Controller - PREMTBVC3
- MultiSITE CRC2+Z Controller - PREMTBVC4
- Simple Remote Controller - PREMTCC00U
- Standard III Remote Controller (White Housing) – PREMTB100
- Standard III Remote Controller (Black Housing) – PREMTBB10
- Remote Temperature Button Sensor - ZRTBS01
- Simple Dry Contact (1 contact, 24 VAC external power) - PDRYCB100
- Dry Contact for Third Party Thermostat - PDRYCB320
- Dry Contact for Economizer - PDRYCB400
- Auxiliary Heater Kit - PRARH1
- Wi-Fi Module - PWFMD200

### Entering Mixed Air:

Cooling (°F DB)	57 ~ 77
Heating (°F WB)	59 ~ 81

### Unit Data:

Refrigerant Type	R410A
Refrigerant Control	EEV
Sound Pressure (H/M/L) dB(A) <sup>2</sup>	31 / 27 / 24
Primary Filter <sup>3</sup>	Washable Pre-filter
Net Weight (lbs.)	26
Shipping Weight (lbs.)	31
Grille Net Weight (lbs.)	7
Grille Shipping Weight (lbs.)	9

### Fan:

Type	Turbo
Quantity	1
Motor/Drive	Brushless Digitally Controlled/Direct
Air Flow H/M/L (CFM)	265 / 212 / 177

### Notes:

1. Acceptable operating voltage: 187V-253V.
2. Sound Pressure levels are tested in an anechoic chamber under ISO Standard 3745.
3. Removable Washable Filter size: 14" x 14" x 1".
4. See Engineering Manual for sensible and latent capacities.
5. All communication / connection (power) cable from the outdoor unit to the indoor unit is field supplied and must be a minimum of four-conductor, 14 AWG, stranded, shielded or unshielded (if shielded, it must be grounded to the chassis of the outdoor unit only), and must comply with applicable local and national codes.
6. Power wiring cable size must comply with the applicable local and national codes.
7. The indoor unit comes with a dry helium charge.
8. Corresponding refrigerant piping length is in accordance with standard length of each outdoor unit and the level difference is 0 ft. All capacities are net with a combination ratio between 95 - 105%.
9. Must follow installation instructions in the applicable LG installation manual.

162279



# LMCN078HV

## Multi F Ceiling Cassette Indoor Unit

7,000 Btu/h

Unit: Inch

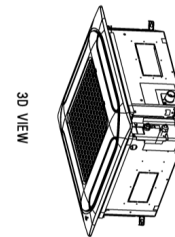
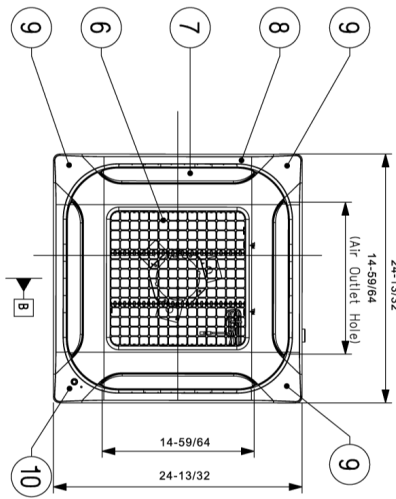
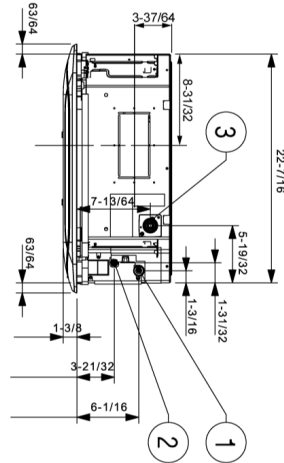
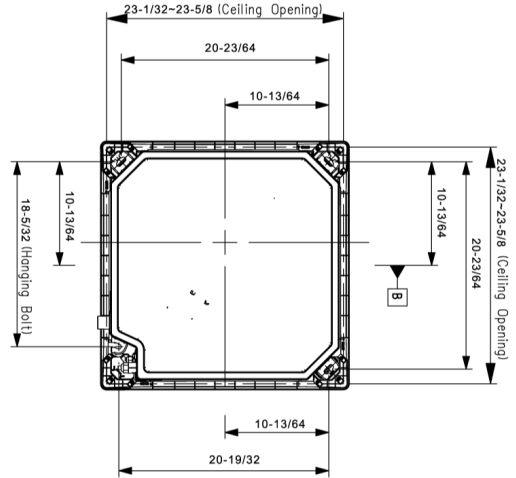
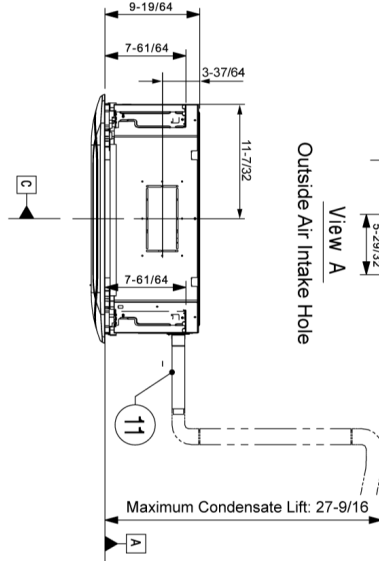
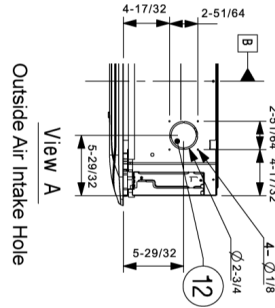
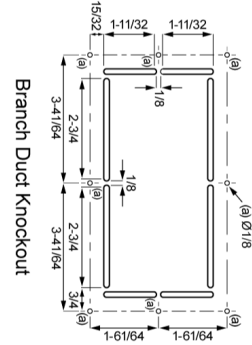

3D VIEW

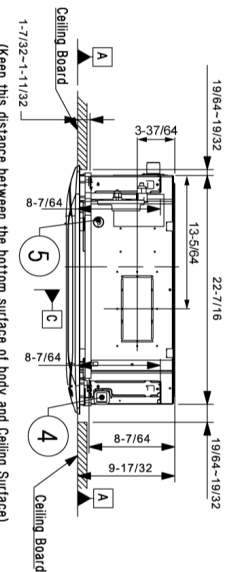

### Symbols

- ↔ View Direction
- ◻ Datum line
- ↔ Refrigerant/Drain Piping Direction

### Note:

1. Unit should be installed in compliance with the installation manual.
2. Unit should be grounded in accordance with the local regulations or applicable national codes.
3. All electrical components and materials to be supplied from the site must comply with the local regulations or international codes.

12	Outside Air Intake Hole	Knock-out type
11	Flexible Drain Hose	Supplied with product
10	Decoration Corner Display Cover	Supplied with panel
9	Decoration Corner Cover	Supplied with panel
8	Decoration Panel (Accessory)	PT-QAGW0
7	Air Outlet	-
6	Air Intake	-
5	Wired remote controller wire routing hole	-
4	Power and Communication cable routing hole	-
3	Drain Pipe Connection	-
2	Liquid Pipe Connection	-
1	Vapor Pipe Connection	-
No.	Part Name	Description