

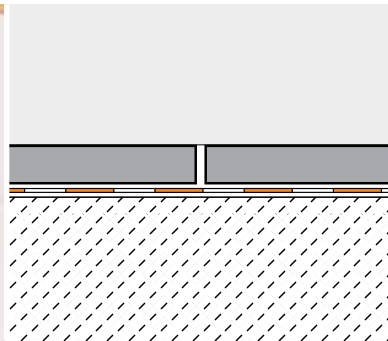

Schluter®-Shower System Installation Handbook 2018



Bonded Waterproofing System for Tiled Showers,
Steam Showers, Steam Rooms, and Bathtub Surrounds



Schluter®-Shower System

Bonded Waterproofing System for Tiled Showers, Steam Showers, Steam Rooms, and Bathtub Surrounds

Ceramic and stone tiles are durable, easy to maintain, and hygienic, representing the ideal surface coverings, particularly in wet areas such as showers and bathtub surrounds. These coverings are not inherently waterproof, however, and must be installed in conjunction with a waterproofing system that effectively manages moisture to protect moisture-sensitive building materials and control mold growth.

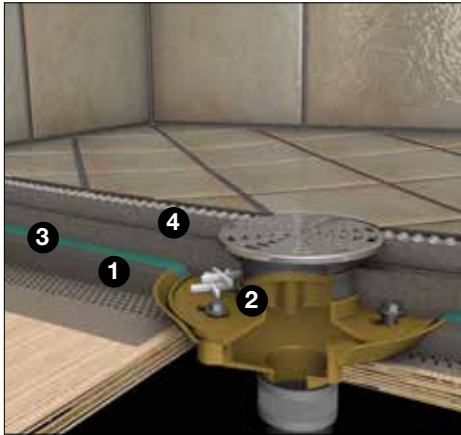

- 1 Pre-slope
- 2 Weep holes
- 3 Pan liner
- 4 Mortar bed

The Traditional Tiled Shower System

The traditional method for installing tiled showers is time and labor intensive and creates a “water in/water out” system. First, a mortar bed is sloped to the weep holes in the drain. The waterproofing membrane, called a pan liner, is placed over this “pre-slope” and clamped into the drain. Pan liners do not allow for the direct application of ceramic or stone tile. Thus, another mortar bed must be installed to provide load distribution and a bonding surface for the floor tile. Finally, a moisture barrier typically must be included behind the solid backing on the walls (e.g., mortar, cement backerboard, etc.) and lapped over the pan liner to protect the wall cavities from moisture penetration and divert that moisture into the pan.

Contrary to popular belief, the tile covering itself is not waterproof. Moisture will infiltrate the mortar bed and solid backing on the walls. This moisture must percolate through the mortar bed to the sloped pan liner and exit through the weep holes in the drain. With regular use of the shower the mortar bed can remain saturated, particularly if pre-slope installation is ignored or the weep holes become clogged, thus increasing the potential for efflorescence and mold growth within the system.

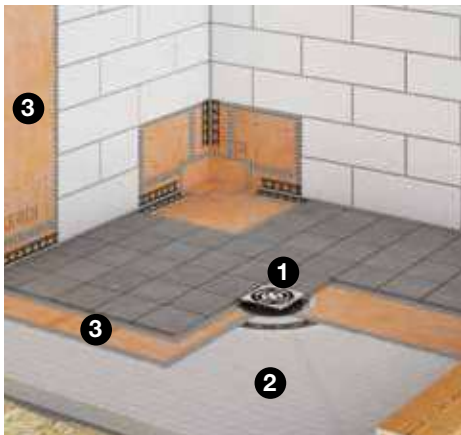

- 1 Schluter®-KERDI-DRAIN
- 2 Sloped mortar bed or Schluter®-KERDI-SHOWER-ST prefabricated foam tray
- 3 Schluter®-KERDI waterproofing membrane

Schluter®-Shower System

The Schluter®-Shower System is an integrated family of products that creates a “sealed” system. First, the Schluter®-KERDI-DRAIN is installed in conjunction with either a sloped mortar bed or the Schluter®-KERDI-SHOWER-ST prefabricated foam tray. The KERDI-DRAIN provides a simple and secure connection to the Schluter®-KERDI waterproofing membrane at the top of the assembly via the unique integrated bonding flange. Unlike shower pan liners in traditional assemblies, KERDI is a bonded waterproofing membrane that allows for the direct application of tile with thin-set mortar. KERDI is bonded to the mortar bed or tray and the surface of the KERDI-DRAIN's integrated bonding flange. In addition, KERDI is installed over the solid backing (e.g., gypsum board, cement backerboard, etc.) on walls, creating a fully waterproof and vapor-tight enclosure.

The resulting assembly provides superior moisture management as it does not permit moisture to penetrate into the mortar bed or solid backing, allowing the assembly to dry completely between uses. The integrated Schluter®-Shower System eliminates leaks, reduces the potential for efflorescence and mold growth in the system, and dramatically reduces total installation time to ensure success and make shower installation easier than ever.

Schluter®-Systems' written installation instructions shall have precedence over referenced industry standard guidelines and installation procedures insofar as referenced information may contain overlapping or conflicting requirements. Type, thickness, and format of the tile or stone surface covering must be suitable for the intended application.

CONTENTS

SHOWER SELECTION GUIDE	4	
SHOWER ASSEMBLY	6	Schluter®-KERDI waterproofing membrane
	8	Schluter®-KERDI-BOARD waterproof building panel
	10	Schluter®-DITRA-HEAT shower application
	12	Curbless showers
STEAM SHOWER ASSEMBLY	14	Schluter®-KERDI waterproofing membrane and Schluter®-KERDI-BOARD waterproof building panel
STEAM ROOM ASSEMBLY	16	Schluter®-KERDI-DS waterproofing membrane
BATHTUB SURROUND	18	Bathtub surround assembly
INSTALLATION	20	Walls and ceilings
	21	Schluter®-KERDI-BOARD-SN shower niche
	22	Shower base with Schluter®-KERDI-DRAIN
	26	Shower base with Schluter®-KERDI-LINE
	32	Bathtub surround
CURBLESS SHOWERS	34	Accessibility and style
THE WATERPROOF BATHROOM	35	Security and utility
PROFILES	36	Details make the difference
TILE SELECTION CONSIDERATIONS	37	Discussion of different tile types in shower applications
THIN-SET FACTS	39	Discussion on thin-set mortar types to be used with Schluter®-KERDI
TESTING, LISTINGS, & APPROVALS	41	Products and system evaluation
MOLD	42	The importance of mold control
VAPOR	43	The importance of water vapor management
PRODUCT & ORDERING INFO	44	
WARRANTIES	54	

SHOWER SELECTION GUIDE

Beautiful, durable, functional

The Schluter®-Shower System is versatile to fit the needs of the installer. The Shower Selection Guide describes the available options to help you determine which products will best fit your shower application.



KERDI



KERDI-BOARD

Waterproofing options

Schluter®-KERDI waterproofing membrane over solid backing

- Thickness: 8 mil (0.2 mm)
- Pliable, easy to install, and guarantees uniform thickness for reliable performance
- Suitable for use in showers, bathtub surrounds, and intermittent-use steam showers

Schluter®-KERDI-DS waterproofing membrane over solid backing

- Thickness: 20 mil (0.5 mm)
- Provides improved vapor permeance as compared to KERDI
- Suitable for use in continuous-use steam rooms

Schluter®-KERDI-BOARD waterproof building panel

- Lightweight, easy to cut and install XPS foam panel
- Combines substrate installation and waterproofing
- Suitable for use in showers, bathtub surrounds, and intermittent-use steam showers



KERDI-DRAIN

Drain options

- Integrated bonding flange ensures waterproof connection at top of assembly
- Can be installed with prefabricated foam shower trays or mortar bases
- Simple connection to standard drain outlets for new construction or renovation
- Grate assemblies accommodate a wide range of tile thicknesses

Schluter®-KERDI-DRAIN

- Fully adjustable square grate assemblies minimize and simplify tile cuts
- Available with 2" or 3" (50 mm or 75 mm) outlets
- Adaptor kits allow for conversion of existing clamping ring drain to KERDI-DRAIN

Schluter®-KERDI-LINE

- Accommodates single-plane slope and large-format tile installation
- Can be installed adjacent to walls or at intermediate locations



KERDI-LINE



KERDI-SHOWER-ST



Mortar Bed

Shower base options

Schluter prefabricated shower trays

- Lightweight, easy to install
- Reduces installation time
- Available in a variety of formats to suit your installation needs
- Can be cut to size or extended using dry pack mortar

Portland cement mortar bed

- Base can be built for custom shower, fits any shape
- Especially suited for off-set drain placement

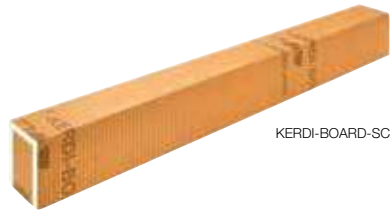

KERDI-BOARD-SC



KERDI-SHOWER-SC



KERDI-BOARD



Built-up Curb



KERDI-BOARD-SB



KERDI-SHOWER-SB



KERDI-BOARD



Curb options

Schluter®-KERDI-BOARD-SC curb

- Waterproof and ready for tile
- Lightweight, stable, and load bearing
- Can be cut to length
- Can be used with Schluter prefabricated shower trays or mortar base applications

Schluter®-KERDI-SHOWER-SC curb

- Preformed, lightweight and easy to install
- Can be cut to length
- Can be used with Schluter prefabricated shower trays or mortar base applications

Schluter®-KERDI-BOARD curb

- Customizable to fit any application
- Build as desired (e.g., length, width, height)
- Can be installed over various materials (e.g., masonry, wood)

Built-up curb

- Customizable to fit any application
- Can be built as desired (e.g., length, width, height)

Bench options

Schluter®-KERDI-BOARD-SB bench

- Waterproof and ready for tile
- Lightweight, stable, and load bearing
- Available in triangular and rectangular shapes in various sizes
- Triangular benches include KERDI-KERECK and KERDI-KERS-B preformed waterproofing corners
- Rectangular benches include KERDI-KERECK preformed waterproofing corners

Schluter®-KERDI-SHOWER-SB bench

- Preformed, lightweight, easy to install
- Available in triangular and rectangular shapes in various sizes

Schluter®-KERDI-BOARD bench

- Customizable to fit any application, can be built as desired
- Combines substrate installation and waterproofing

Built-up bench

- Customizable to fit any application
- Can be built as desired (e.g., length, width, height)

Shower niche

Schluter®-KERDI-BOARD-SN shower niche

- Prefabricated shower niche made of KERDI-BOARD
- Preformed, lightweight, easy to install
- Various sizes available

SHOWER ASSEMBLY

Showers – Ceramic or stone tile

Schluter®-KERDI waterproofing membrane

K-SH-K-18

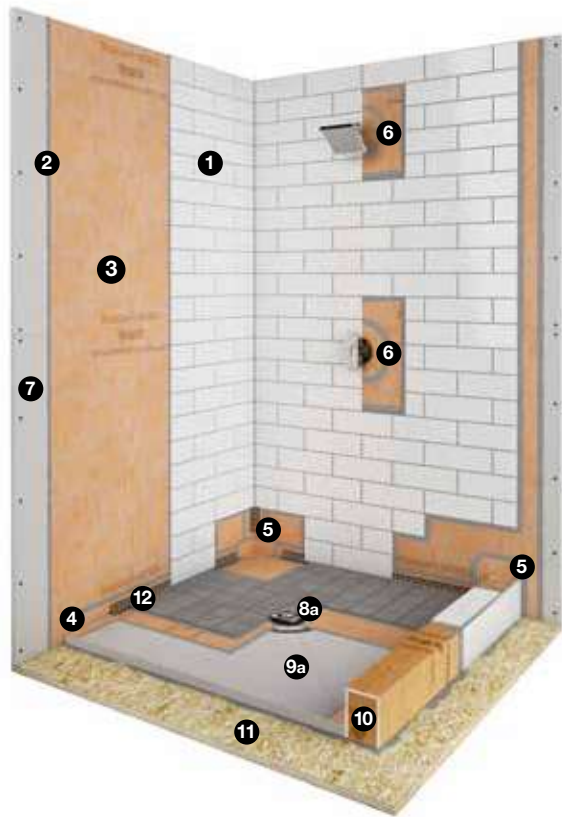

❶ Ceramic or stone tile

❷ Schluter **SET™**, Schluter **ALL-SET™**, Schluter **FAST-SET™** or unmodified thin-set mortar

❸ Schluter®-**KERDI** waterproofing membrane

❹ Schluter®-**KERDI-BAND** waterproofing strips

❺ Schluter®-**KERDI-KERECK-F** waterproofing corners

❻ Schluter®-**KERDI-SEAL-PS/-MV** seals or Schluter®-**KERDI-FIX** sealant and bonding compound

❼ Solid backing

❽ Drain:

- a. Schluter®-**KERDI-DRAIN**
- b. Schluter®-**KERDI-LINE**

❾ Base:

- a. Schluter®-**KERDI-SHOWER-ST**
- b. Schluter®-**KERDI-SHOWER-L/-LS**

Alternative (not shown):

- Mortar bed

❿ Schluter®-**KERDI-BOARD-SC** curb

Alternatives (not shown):

- Schluter®-**KERDI-SHOWER-SC** curb
- Schluter®-**KERDI-BOARD** waterproof building panel
- Built-up curb

⓫ Wood or concrete subfloor

⓬ Schluter®-**DILEX** profile (optional)

Bench (not shown):

- Schluter®-**KERDI-BOARD-SB** bench (optional)
- Schluter®-**KERDI-SHOWER-SB** bench (optional)
- Schluter®-**KERDI-BOARD** bench (optional)

Niche (not shown):

- Schluter®-**KERDI-BOARD-SN** niche (optional)

Schluter®-KERDI waterproofing membrane

K-SH-K-18

Areas of Application

- ▲ Interior showers.
- ▲ Over wood or concrete subfloors. See the Base information under Requirements (below) for details.
- ▲ Areas requiring disabled access/curbless applications; see detail K-SHBF on page 12.

Limitations

- ▲ Certain glass tiles may not be compatible with bonded waterproof membranes and/or may require special setting materials. Consult glass tile manufacturer and Schluter®-Systems for more information.
- ▲ Certain moisture sensitive stones, e.g., green marble, or resin-backed tiles may not be appropriate for use in wet areas such as showers or may require special setting materials. Consult stone supplier and Schluter®-Systems for more information.
- ▲ Do not use sawn lumber curbs on concrete subfloors subject to moisture migration.

Requirements

- ▲ Plywood, OSB, or concrete subfloor must be clean, even, and load bearing.
- ▲ Solid backing – gypsum wallboard, cementitious backer unit, fiber-cement underlayment, fiber-reinforced water-resistant gypsum backerboard/underlayment, coated glass mat water-resistant gypsum backerboard, Portland cement mortar bed, concrete, or masonry.
- ▲ Base – KERDI-SHOWER-ST/-L/-LS or Portland cement mortar bed.
- ▲ Curb – KERDI-BOARD-SC, KERDI-SHOWER-SC, KERDI-BOARD, concrete, masonry block, or sawn lumber sheathed with solid backing (see above).
- ▲ Bench – KERDI-BOARD-SB, KERDI-SHOWER-SB, KERDI-BOARD, concrete, masonry block, or sawn lumber sheathed with solid backing (see above).
- ▲ KERDI-DRAIN/-LINE shall be properly supported.
- ▲ KERDI-DRAIN/-LINE shall be connected to the waste line; use ABS cement for ABS drains, PVC cement for PVC drains, a no-hub coupling for stainless steel drains with no-hub outlets, and thread sealing compound or tape for stainless steel drains with threaded outlets.
- ▲ KERDI waterproofing membrane shall be installed up to the height of the showerhead at minimum.
- ▲ In enclosed shower areas, install KERDI waterproofing membrane on all surfaces, including the ceiling, door jambs and the door header.
- ▲ Any protrusions through the KERDI membrane (e.g., showerhead, mixing valve, etc.) must be treated with KERDI-SEAL-PS/-MV seals, KERDI-FIX or suitable sealant.
- ▲ When using the stainless steel KERDI-DRAIN bonding flange, use KERDI-FIX to bond KERDI to the drain.
- ▲ All horizontal surfaces (e.g., benches, curbs, window sills, shelves, etc.) must be sloped toward the shower drain. This can be done by sloping the substrate or the tile.

Substrate Preparation

- ▲ Verify that subfloor panels and solid backing are properly fastened to framing members.
- ▲ Any leveling of the subfloor must be done prior to installing KERDI-SHOWER-ST/-L/-LS/-SB/-SC/-SR and KERDI-BOARD-SC/-SB.

Solid Backing Materials

- ▲ Gypsum wallboard – ASTM C1396/C1396M
- ▲ Cementitious backer unit – ANSI A118.9 or ASTM C1325
- ▲ Fiber-cement underlayment – ASTM C1288
- ▲ Fiber-reinforced water-resistant gypsum backerboard/underlayment – ASTM C1278
- ▲ Coated glass mat water-resistant gypsum backerboard – ASTM C1178
- ▲ Portland cement mortar – ANSI A108.1B
- ▲ Concrete
- ▲ Masonry

Setting and Grouting Materials

- ▲ Unmodified thin-set mortar – ANSI A118.1
- ▲ Grout – ANSI A118.3, A118.6, A118.7

Installation Specifications

- ▲ Solid backing panels – follow manufacturer's instructions
- ▲ Portland cement mortar bed – ANSI A108.1B
- ▲ Tile – ANSI A108.5
- ▲ Grout – ANSI A108.6, A108.10

Other Considerations

- ▲ When KERDI-SHOWER-ST/-L/-LS tray dimensions do not match the dimensions of the shower compartment, the tray may be cut or extended with dry pack mortar.
- ▲ When KERDI and tile are installed on the ceiling, the solid backing and fasteners must be able to support the load of the tile and setting and grouting materials.
- ▲ A water test is strongly recommended before setting tile to verify a successful installation. Wait 24 hours minimum after the membrane installation is complete to allow for final set of thin-set mortar and ensure waterproof performance at seams and connections. Refer to local plumbing codes for any specific requirements in your area.
- ▲ Schluter®-Systems profiles may be used to finish and protect outside corners and eliminate the use of sealant at inside corners; see page 36.
- ▲ Schluter®-SHOWERPROFILE-S/-R profiles eliminate the need for cutting wedges of tile by covering the exposed wall area where the floor slopes to KERDI-LINE.

SHOWER ASSEMBLY

Showers – Ceramic or stone tile

Schluter®-KERDI-BOARD waterproof building panel

K-SH-KB-18

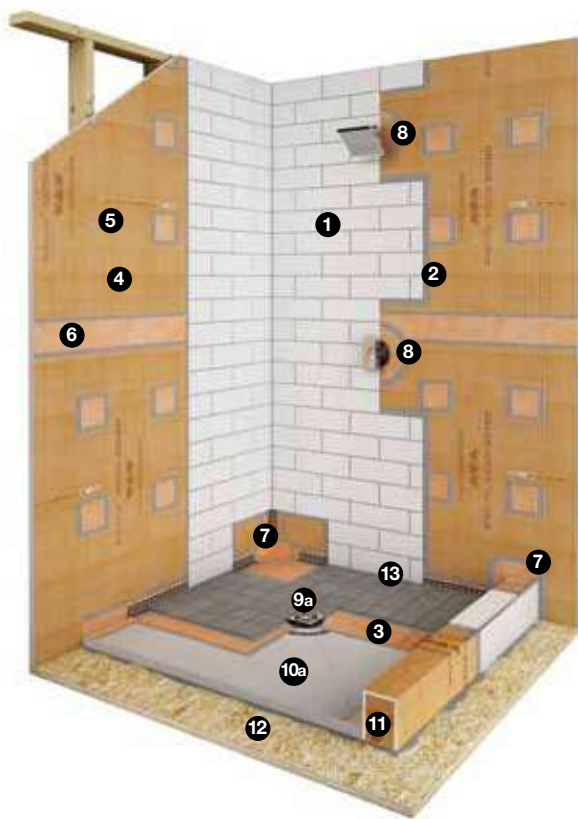

- 1 Ceramic or stone tile
- 2 Schluter **SET™**, Schluter **ALL-SET™**, Schluter **FAST-SET™** or unmodified thin-set mortar
- 3 Schluter®-**KERDI** waterproofing membrane
- 4 Schluter®-**KERDI-BOARD** waterproof building panel
- 5 Schluter®-**KERDI-BOARD-ZT** washers
- 6 Schluter®-**KERDI-BAND** waterproofing strips
- 7 Schluter®-**KERDI-KERECK-F** waterproofing corners
- 8 Schluter®-**KERDI-SEAL-PS/-MV** seals or Schluter®-**KERDI-FIX** sealant and bonding compound
- 9 Drain:
 - a. Schluter®-**KERDI-DRAIN**
 - b. Schluter®-**KERDI-LINE**
- 10 Base:
 - a. Schluter®-**KERDI-SHOWER-ST**
 - b. Schluter®-**KERDI-SHOWER-L/-LS**

Alternative (not shown):

 - Mortar bed
- 11 Schluter®-**KERDI-BOARD-SC** curb

Alternatives (not shown):

 - Schluter®-**KERDI-SHOWER-SC** curb
 - Schluter®-**KERDI-BOARD** waterproofing panel
 - Built-up curb
- 12 Wood or concrete subfloor
- 13 Schluter®-**DILEX** profile (optional)

- Bench (not shown):

 - Schluter®-**KERDI-BOARD-SB** bench (optional)
 - Schluter®-**KERDI-SHOWER-SB** bench (optional)
 - Schluter®-**KERDI-BOARD** bench (optional)

- Niche (not shown):

 - Schluter®-**KERDI-BOARD-SN** niche (optional)

Schluter®-KERDI-BOARD waterproof building panel

K-SH-KB-18

Areas of Application

- ▲ Interior showers.
- ▲ Over wood or concrete subfloors. See the Base information under Requirements (below) for details.
- ▲ Areas requiring disabled access/curbless applications; see detail K-SHBF on page 12.

Limitations

- ▲ Certain glass tiles may not be compatible with bonded waterproof membranes and/or may require special setting materials. Consult glass tile manufacturer and Schluter®-Systems for more information.
- ▲ Certain moisture-sensitive stones, e.g., green marble, or resin-backed tiles, may not be appropriate for use in wet areas such as showers or may require special setting materials. Consult stone supplier and Schluter®-Systems for more information.
- ▲ Do not use sawn lumber curbs on concrete subfloors subject to moisture migration.

Requirements

- ▲ Plywood, OSB, or concrete subfloor must be clean, even, and load bearing.
- ▲ Base – KERDI-SHOWER-ST/-L/-LS or Portland cement mortar bed.
- ▲ Curb – KERDI-BOARD-SC, KERDI-SHOWER-SC, KERDI-BOARD, concrete, masonry block, or sawn lumber sheathed with solid backing (see below).
- ▲ Bench – KERDI-BOARD-SB, KERDI-SHOWER-SB, KERDI-BOARD, concrete, masonry block, or sawn lumber sheathed with solid backing (see below).
- ▲ Solid backing – gypsum wallboard, cementitious backer unit, fiber-cement underlayment, fiber-reinforced water-resistant gypsum backerboard/underlayment, coated glass mat water-resistant gypsum backerboard, Portland cement mortar bed, concrete, or masonry.
- ▲ KERDI-DRAIN/-LINE shall be properly supported.
- ▲ KERDI-DRAIN/-LINE shall be connected to the waste line; use ABS cement for ABS drains, PVC cement for PVC drains, a no-hub coupling for stainless steel drains with no-hub outlets, and thread sealing compound or tape for stainless steel drains with threaded outlets.
- ▲ Minimum KERDI-BOARD thickness – 1/2" (12.5 mm) for studs spaced at 16" (40.6 cm) o.c. and 3/4" (19 mm) for studs spaced at 24" (61.0 cm) o.c.
- ▲ KERDI-BOARD shall be fastened to wood or metal framing with appropriate screws (i.e., coarse thread wood screw for wood studs and self-tapping for metal studs) and corresponding KERDI-BOARD-ZT washers. Screws must reach a depth of at least 3/4" (20 mm) in wood studs and 3/8" (10 mm) in metal studs. Maximum allowable on-center fastener spacing is 12" (30 cm) for walls and 6" (15 cm) for ceilings.
- ▲ KERDI-BOARD shall be installed up to the height of the showerhead at minimum.
- ▲ In enclosed shower areas, install KERDI waterproofing membrane on all surfaces, including the ceiling, door jambs and the door header.
- ▲ Any protrusions through the KERDI-BOARD (e.g., showerhead, mixing valve, etc.) must be treated with KERDI-SEAL-PS/-MV seals, KERDI-FIX or suitable sealant.
- ▲ When using the stainless steel KERDI-DRAIN bonding flange, use KERDI-FIX to bond KERDI to the drain.
- ▲ All horizontal surfaces (e.g., benches, curbs, window sills, shelves, etc.) must be sloped toward the shower drain. This can be done by sloping the substrate or the tile.

Substrate Preparation

- ▲ Verify that subfloor panels are properly fastened to framing members.
- ▲ Any leveling of the subfloor must be done prior to installing KERDI-SHOWER-ST/-L/-LS/-SB/-SC/-SR or KERDI-BOARD-SC/-SB.

Solid Backing Materials

- ▲ Gypsum wallboard – ASTM C1396/C1396M
- ▲ Cementitious backer unit – ANSI A118.9 or ASTM C1325
- ▲ Fiber-cement underlayment – ASTM C1288
- ▲ Fiber-reinforced water-resistant gypsum backerboard/underlayment – ASTM C1278
- ▲ Coated glass mat water-resistant gypsum backerboard – ASTM C1178
- ▲ Portland cement mortar – ANSI A108.1B
- ▲ Concrete
- ▲ Masonry

Setting and Grouting Materials

- ▲ Unmodified thin-set mortar – ANSI A118.1
- ▲ Grout – ANSI A118.3, A118.6, A118.7

Installation Specifications

- ▲ Portland cement mortar bed – ANSI A108.1B
- ▲ Tile – ANSI A108.5
- ▲ Grout – ANSI A108.6, A108.10

Other Considerations

- ▲ When KERDI-SHOWER-ST/-L/-LS tray dimensions do not match the dimensions of the shower compartment, the tray may be cut or extended with dry pack mortar.
- ▲ Shower grab bars must be anchored in the structure or solid blocking behind KERDI-BOARD.
- ▲ When KERDI-BOARD and tile are installed on the ceiling, the fasteners must be able to support the load of the tile and setting and grouting materials.
- ▲ A water test is strongly recommended before setting tile to verify a successful installation. Wait 24 hours minimum after the membrane installation is complete to allow for final set of thin-set mortar and ensure waterproof performance at seams and connections. Refer to local plumbing codes for any specific requirements in your area.
- ▲ Schluter®-Systems profiles may be used to finish and protect outside corners and eliminate the use of sealant at inside corners; see page 36.
- ▲ Schluter®-SHOWERPROFILE-S/-R profiles eliminate the need for cutting wedges of tile by covering the exposed wall area where the floor slopes to KERDI-LINE.

SHOWER ASSEMBLY

Showers – Ceramic or stone tile

Schluter®-DITRA-HEAT Shower Application

DH-SH-18

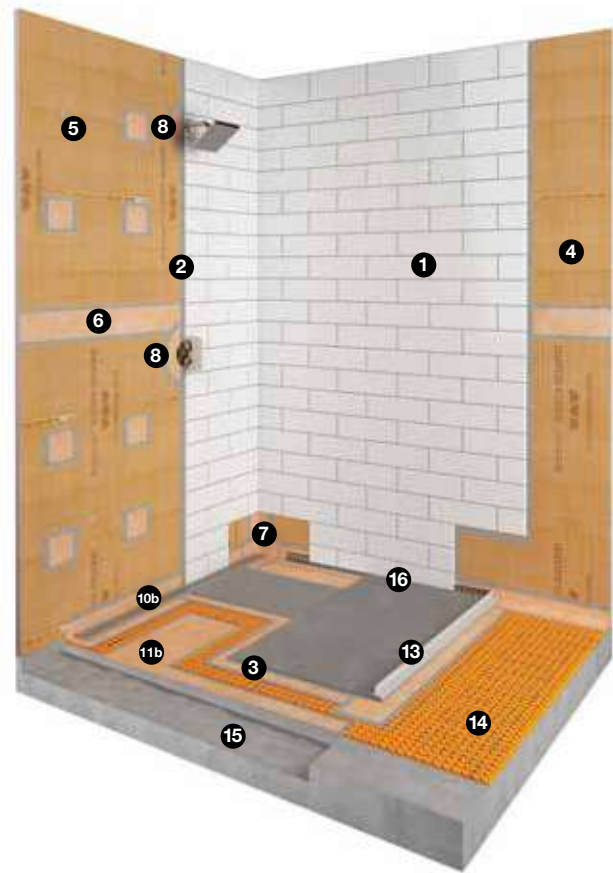

- 1 Ceramic or stone tile
- 2 Schluter **SET™**, Schluter **ALL-SET™**, Schluter **FAST-SET™** or unmodified thin-set mortar
- 3 Schluter®-**KERDI** waterproofing membrane
- 4 Schluter®-**KERDI-BOARD** waterproof building panel
- 5 Schluter®-**KERDI-BOARD-ZT/-ZS** washers and screws
- 6 Schluter®-**KERDI-BAND** waterproofing strips
- 7 Schluter®-**KERDI-KERECK-F** waterproofing corners
- 8 Schluter®-**KERDI-SEAL-PS/-MV** seals or Schluter®-**KERDI-FIX** sealant and bonding compound
- 9 Solid backing
- 10 Drain:
 - a. Schluter®-**KERDI-DRAIN**
 - b. Schluter®-**KERDI-LINE**
- 11 Base:
 - a. Schluter®-**KERDI-SHOWER-ST**
 - b. Schluter®-**KERDI-SHOWER-L/-LS**

Alternative (not shown):

 - Mortar bed
- 12 Schluter®-**KERDI-BOARD-SC** curb

Alternatives (not shown):

 - Schluter®-**KERDI-SHOWER-SC** curb
 - Schluter®-**KERDI-BOARD** waterproof building panel
 - Built-up curb
- 13 Schluter®-**SHOWERPROFILE-WSK/-WSL** Shower profile

Alternative (not shown):

 - Schluter®-**SHOWERPROFILE-WS/-WSC**
- 14 Schluter®-**DITRA-HEAT** or Schluter®-**DITRA-HEAT-DUO** Electric floor warming and uncoupling membrane
- 15 Wood or concrete subfloor
- 16 Schluter®-**DILEX** profile (optional)

Bench (not shown, optional):

 - Schluter®-**KERDI-BOARD-SB** bench
 - Schluter®-**KERDI-SHOWER-SB** bench
 - Schluter®-**KERDI-BOARD** bench

Niche (not shown, optional):

 - Schluter®-**KERDI-BOARD-SN** niche

Schluter®-DITRA-HEAT Shower Application

DH-SH-18

Areas of Application

- ▲ Interior showers with or without curbless applications.
- ▲ Interior intermittent use steam showers (e.g., residential applications). See detail K-SHH-18 in the Schluter®-Shower System Installation Handbook for more information.
- ▲ Over wood or concrete subfloors. See the Base information under Requirements (below) for details.

Limitations

- ▲ Certain glass tiles may not be compatible with bonded waterproof membranes and/or may require special setting materials. Consult glass tile manufacturer and Schluter®-Systems for more information.
- ▲ Certain moisture sensitive stones, e.g., green marble, or resin-backed tiles may not be appropriate for use in wet areas such as showers or may require special setting materials. Consult stone supplier and Schluter®-Systems for more information.
- ▲ Do not use sawn lumber curbs on concrete subfloors subject to moisture migration.

Requirements

- ▲ Plywood, OSB, or concrete subfloor must be clean, even, and load bearing.
- ▲ For wood substrates, subfloor/underlayment configuration according to detail DH-W16-T, DH-W19-T, DH-W24-T, or DH-W-S.
- ▲ For curbless applications: Recessing the floor of a bathroom must be done in a way that preserves the structural integrity and safety of the construction. This may require the services of a qualified design professional (e.g., architect, engineer, etc.).
- ▲ Solid backing – gypsum wallboard, cementitious backer unit, fiber-cement underlayment, fiber-reinforced water-resistant gypsum backerboard/underlayment, coated glass mat water-resistant gypsum backerboard, Portland cement mortar bed, concrete, or masonry.
- ▲ Minimum KERDI-BOARD thickness – 1/2" (12.5 mm) for studs spaced at 16" (40.6 cm) o.c. and 3/4" (19 mm) for studs spaced at 24" (61.0 cm) o.c.
- ▲ KERDI-BOARD shall be fastened to wood or metal framing with appropriate screws (i.e., coarse thread wood screw for wood studs and self-tapping for metal studs) and corresponding KERDI-BOARD-ZT washers. Screws must reach a depth of at least 3/4" (20 mm) in wood studs and 3/8" (10 mm) in metal studs. Maximum allowable on-center fastener spacing is 12" (30 cm) for walls and 6" (15 cm) for ceilings.
- ▲ KERDI or KERDI-BOARD shall be installed up to the height of the showerhead at minimum. In enclosed shower areas, install KERDI waterproofing membrane on all surfaces, including the ceiling, door jams and the door header.
- ▲ Any protrusions through the KERDI or KERDI-BOARD (e.g., showerhead, mixing valve, etc.) must be treated with KERDI-SEAL-PS/-MV seals, KERDI-FIX or suitable sealant.
- ▲ Base – KERDI-SHOWER-ST/-L/-LS or Portland cement mortar bed.
- ▲ Ramp – KERDI-SHOWER-SR or Portland cement mortar bed.
- ▲ Curb – KERDI-SHOWER-SC, KERDI-BOARD-SC, KERDI-BOARD, concrete, masonry block, or sawn lumber sheathed with solid backing (see above).
- ▲ Bench – KERDI-BOARD-SB, KERDI-SHOWER-SB, KERDI-BOARD, concrete, masonry block, or sawn lumber sheathed with solid backing (see above).
- ▲ All horizontal surfaces (e.g., benches, curbs, window sills, shelves, etc.) must be sloped toward the shower drain. This can be done by sloping the substrate or the tile.
- ▲ KERDI-DRAIN/-LINE shall be properly supported. Additional thin-set mortar may be needed to bed the KERDI-DRAIN for this detail.
- ▲ KERDI-DRAIN/-LINE shall be connected to the waste line; use ABS cement for ABS drains, PVC cement for PVC drains, a no-hub coupling for stainless steel drains with no-hub outlets, and thread sealing compound or tape for stainless steel drains with threaded outlets.
- ▲ When using the stainless steel KERDI-DRAIN bonding flange, use KERDI-FIX to bond KERDI to the drain.
- ▲ DITRA-HEAT heating cables must be installed in the DITRA-HEAT or DITRA-HEAT-DUO membrane. KERDI must be installed over the heating cables and DITRA-HEAT/-DUO in the shower.
- ▲ Due to the installation of the DITRA-HEAT membrane on top of the shower tray, it is necessary to raise the height of the KERDI-DRAIN/LINE. Installation of DITRA-HEAT membrane on the substrate under the detachable center section for KERDI-DRAIN or under the KERDI-LINE channel body support will provide the proper height adjustment.
- ▲ When a curb is used, the heating cables must be installed over the curb in a 3/4" wide x 1/4" deep routed section and encased in thin-set mortar. **DO NOT install the heating cable under the curb or go through the curb, as this could cause damage to the heating cable and curb. After the heating cable is installed, apply KERDI over the routed section of the KERDI-BOARD-SC curb.**
- ▲ A dedicated heating cable is recommended in the shower area to allow for simple disconnection without an impact on the bathroom floor heating in the event that the shower heating cable is damaged. Multiple heating cables may be installed on a single thermostat, up to the 15 amp limit.

Note: Please refer to the Schluter®-DITRA-HEAT Installation Handbook for installation instructions and warranty criteria for the Schluter®-DITRA-HEAT floor warming system.

- ▲ Heating cables must be installed 3 studs from the edge of the KERDI-LINE flange and 2 studs from the edge of the KERDI-DRAIN flange.

Safety

- ▲ Repairs to the DITRA-HEAT heating cable in the shower may not be approved. Verify with the local inspector or authority having jurisdiction (AHJ). Flood testing the shower is recommended before re-tiling.
- ▲ Heating cable factory splice (i.e., cold lead splice) must not be installed in the shower area.

Substrate Preparation

- ▲ Verify that subfloor panels and solid backing are properly fastened to framing members.
- ▲ Any leveling of the subfloor must be done prior to installing KERDI-SHOWER-ST/-L/-LS/-SC/-SB/-SR, KERDI-BOARD-SC/-SB, DITRA-HEAT, and DITRA-HEAT-DUO membranes.

Solid Backing Materials

- ▲ Gypsum wallboard – ASTM C1396/C1396M
- ▲ Cementitious backer unit – ANSI A118.9 or ASTM C1325
- ▲ Fiber-cement underlayment – ASTM C1288
- ▲ Fiber-reinforced water-resistant gypsum backerboard/underlayment – ASTM C1278
- ▲ Coated glass mat water-resistant gypsum backerboard – ASTM C1178
- ▲ Portland cement mortar – ANSI A108.1B
- ▲ Concrete
- ▲ Masonry

Setting and Grouting Materials

- ▲ Unmodified thin-set mortar – ANSI A118.1
- ▲ Grout – ANSI A118.3, A118.6, A118.7

Installation Specifications

- ▲ Solid backing panels – follow manufacturer's instructions
- ▲ Portland cement mortar bed – ANSI A108.1B
- ▲ Tile – ANSI A108.5
- ▲ Grout – ANSI A108.6, A108.10

Other Considerations

- ▲ Acceptance of electric floor warming in a shower and this detail must be verified by the local inspector or authority having jurisdiction (AHJ).
- ▲ KERDI is required on top of DITRA-HEAT installations in the shower. Schluter®-Systems chooses to be conservative and to ensure everything is protected. Note: DITRA-HEAT-E-HK heating cables are rated for wet applications per CAN/CSA-C22.2 No.130-03.DITRA-HEAT membranes have been found to meet or exceed the requirements of ANSI A118.10.
- ▲ Curbless tiled showers rely on the slope of the floor to effectively contain water in the immediate shower area and direct water to the drain. Given the wide range of potential configurations, it isn't possible to address them all in this Handbook.
- ▲ For curbless applications: waterproofing must be installed in all areas subject to water exposure.
- ▲ Schluter®-SHOWERPROFILE-WS/-WSK system profiles can be used to form a splashguard at the entrance of curbless showers.
- ▲ Various building codes and other sources, such as the Americans with Disabilities Act, include specific requirements for disabled access in public buildings and must be consulted when applicable. Areas of interest may include degree of slope, clearance, and supporting structures such as grab bars.
- ▲ Shower grab bars must be anchored in the structure or solid blocking behind KERDI-BOARD.
- ▲ When KERDI-SHOWER-ST/-L/-LS tray dimensions do not match the dimensions of the shower compartment, the tray may be cut or extended with dry pack mortar.
- ▲ When KERDI or KERDI-BOARD and tile are installed on the ceiling, the solid backing and fasteners must be able to support the load of the tile and setting and grouting materials.
- ▲ A water test is strongly recommended before setting tile to verify a successful installation. Wait 24 hours minimum after the membrane installation is complete to allow for final set of thin-set mortar and ensure waterproof performance at seams and connections. Refer to local plumbing codes for any specific requirements in your area. For curbless showers a temporary dam (e.g., a 2x4 and silicone sealant, plastic sheeting and sand, etc.) must be provided at the threshold to perform the water test.
- ▲ Schluter®-Systems profiles may be used to finish and protect outside corners and eliminate the use of sealant at inside corners.
- ▲ Schluter®-SHOWERPROFILE-S/-R profiles eliminate the need for cutting wedges of tile by covering the exposed wall area where the floor slopes to KERDI-LINE.

SHOWER ASSEMBLY

Curbless Showers – Ceramic or stone tile

Schluter®-KERDI waterproofing membrane or Schluter®-KERDI-BOARD waterproof building panel

K-SHBF-18

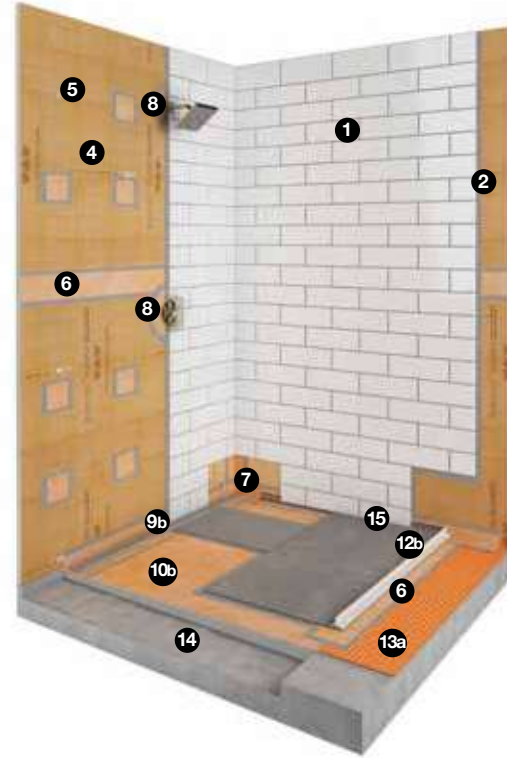
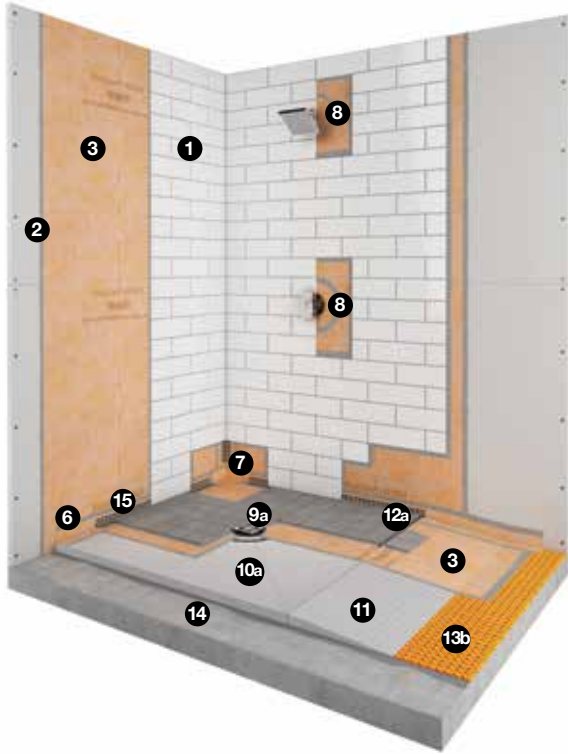

- ❶ Ceramic or stone tile
- ❷ Schluter **SET™**, Schluter **ALL-SET™**, Schluter **FAST-SET™** or unmodified thin-set mortar
- ❸ Schluter®-**KERDI** waterproofing membrane
- ❹ Schluter®-**KERDI-BOARD** waterproof building panel
- ❺ Schluter®-**KERDI-BOARD-ZT** washers
- ❻ Schluter®-**KERDI-BAND** waterproofing strips
- ❼ Schluter®-**KERDI-KERECK-F** waterproofing corners
- ❽ Schluter®-**KERDI-SEAL-PS/-MV** seals or Schluter®-**KERDI-FIX** sealant and bonding compound
- ❾ Drain:
 - a. Schluter®-**KERDI-DRAIN**
 - b. Schluter®-**KERDI-LINE**
- ❿ Base:
 - a. Schluter®-**KERDI-SHOWER-ST**
 - b. Schluter®-**KERDI-SHOWER-L/-LS**

Alternative (not shown):

 - Mortar bed
- ⓫ Schluter®-**KERDI-SHOWER-SR** ramp

Alternative (not shown):

 - Mortar ramp
- ⓬ Shower profiles:
 - a. Schluter®-**SHOWERPROFILE-WS/-WSC**
 - b. Schluter®-**SHOWERPROFILE-WSK/-WSL**
- ⓭ Uncoupling membrane:
 - a. Schluter®-**DITRA** uncoupling membrane
 - b. Schluter®-**DITRA-HEAT** electric floor warming and uncoupling membrane

Alternative (not shown):

 - Schluter®-**KERDI** waterproofing membrane
- ⓮ Wood or concrete subfloor
- ⓯ Schluter®-**DILEX** profile (optional)

- Bench (not shown):

 - Schluter®-**KERDI-BOARD-SB** bench (optional)
 - Schluter®-**KERDI-SHOWER-SB** bench (optional)
 - Schluter®-**KERDI-BOARD** bench (optional)

- Niche (not shown):

 - Schluter®-**KERDI-BOARD-SN** niche (optional)

Schluter®-KERDI waterproofing membrane or Schluter®-KERDI-BOARD waterproof building panel

K-SHBF-18

Areas of Application

- ▲ Interior showers with curbless access.
- ▲ Over wood or concrete subfloors. See the Base information under Requirements (below) for details.

Limitations

- ▲ Certain glass tiles may not be compatible with bonded waterproof membranes and/or may require special setting materials. Consult glass tile manufacturer and Schluter®-Systems for more information.
- ▲ Certain moisture sensitive stones, e.g., green marble, or resin-backed tiles may not be appropriate for use in wet areas such as steam showers or may require special setting materials. Consult stone supplier and Schluter®-Systems for more information.

Requirements

- ▲ Plywood, OSB, or concrete subfloor must be clean, even, and load bearing.
- ▲ Recessing the floor of a bathroom must be done in a way that preserves the structural integrity and safety of the construction. This may require the services of a qualified design professional (e.g., architect, engineer, etc.).
- ▲ Solid backing – gypsum wallboard, cementitious backer unit, fiber-cement underlayment, fiber-reinforced water-resistant gypsum backerboard/underlayment, coated glass mat water-resistant gypsum backerboard, Portland cement mortar bed, concrete, or masonry.
- ▲ Base – KERDI-SHOWER-ST/-L/-LS or Portland cement mortar bed.
- ▲ Ramp – KERDI-SHOWER-SR or Portland cement mortar bed.
- ▲ Bench – KERDI-BOARD-SB, KERDI-SHOWER-SB, KERDI-BOARD, concrete, masonry block, or sawn lumber sheathed with solid backing (see above).
- ▲ KERDI-DRAIN/-LINE shall be properly supported.
- ▲ KERDI-DRAIN/-LINE shall be connected to the waste line; use ABS cement for ABS drains, PVC cement for PVC drains, a no-hub coupling for stainless steel drains with no-hub outlets, and thread sealing compound or tape for stainless steel drains with threaded outlets.
- ▲ Minimum KERDI-BOARD thickness – 1/2" (12.5 mm) for studs spaced at 16" (40.6 cm) o.c. and 3/4" (19 mm) for studs spaced at 24" (61.0 cm) o.c.
- ▲ KERDI-BOARD shall be fastened to wood or metal framing with appropriate screws (i.e., coarse thread wood screw for wood studs and self-tapping for metal studs) and corresponding KERDI-BOARD-ZT washers. Screws must reach a depth of at least 3/4" (20 mm) in wood studs and 3/8" (10 mm) in metal studs. Maximum allowable on-center fastener spacing is 12" (30 cm) for walls and 6" (15 cm) for ceilings.
- ▲ KERDI or KERDI-BOARD shall be installed up to the height of the showerhead at minimum.
- ▲ In enclosed shower areas, install KERDI or KERDI-BOARD on all surfaces, including the ceiling, door jambs and the door header.
- ▲ KERDI, DITRA or DITRA-HEAT shall be installed in all floor areas subject to water exposure (i.e., wet area and drying area). Floor/wall connections shall be sealed with KERDI-BAND.
- ▲ Any protrusions through the KERDI or KERDI-BOARD (e.g., showerhead, mixing valve, etc.) must be treated with KERDI-SEAL-PS/-MV seals, KERDI-FIX or suitable sealant.
- ▲ When using the stainless steel KERDI-DRAIN bonding flange, use KERDI-FIX to bond KERDI to the drain.
- ▲ All horizontal surfaces (e.g. benches, window sills, shelves, etc.) must be sloped toward the shower drain. This can be done by sloping the substrate or the tile.

Substrate Preparation

- ▲ Verify that subfloor panels and solid backing are properly fastened to framing members.
- ▲ Any leveling of the subfloor must be done prior to installing KERDI-SHOWER-ST/-L/-LS/-SB/-SR and KERDI-BOARD-SB prefabricated substrates.

Solid Backing Materials

- ▲ Gypsum wallboard – ASTM C1396/C1396M
- ▲ Cementitious backer unit – ANSI A118.9 or ASTM C1325
- ▲ Fiber-cement underlayment – ASTM C1288
- ▲ Fiber-reinforced water-resistant gypsum backerboard/underlayment – ASTM C1278
- ▲ Coated glass mat water-resistant gypsum backerboard – ASTM C1178
- ▲ Portland cement mortar – ANSI A108.1B
- ▲ Concrete
- ▲ Masonry

Setting and Grouting Materials

- ▲ Unmodified thin-set mortar – ANSI A118.1
- ▲ Grout – ANSI A118.3, A118.6, A118.7

Installation Specifications

- ▲ Solid backing panels – follow manufacturer's directions
- ▲ Portland cement mortar bed – ANSI A108.1B
- ▲ Tile – ANSI A108.5
- ▲ Grout – ANSI A108.6, A108.10

Other Considerations

- ▲ Curbless tiled showers rely on the slope of the floor to effectively contain water in the immediate shower area and direct water to the drain. Given the wide range of potential configurations, it isn't possible to address them all in this Handbook.
- ▲ Waterproofing must be installed in all areas subject to water exposure. Install KERDI over mortar beds and Schluter® prefabricated EPS foam substrates. Use the DITRA or DITRA-HEAT uncoupling membrane over plywood/OSB or concrete subfloors. All seams are sealed using KERDI-BAND. Please refer to the Schluter®-DITRA or Schluter®-DITRA-HEAT Installation Handbooks for complete details and warranty criteria.
- ▲ If KERDI-LINE is placed at shower entrance, it is recommended that grate assembly A, Pure, or the covering support (D) is chosen and that the drainage openings span the maximum width of the entrance to limit potential overflow; secondary drainage (e.g., KERDI-DRAIN) may be required in the drying area.
- ▲ Schluter®-SHOWERPROFILE-WS/-WSK system profiles can be used to form a splashguard at the entrance of curbless showers. See page 33.
- ▲ Various building codes and other sources, such as the Americans with Disabilities Act, include specific requirements for disabled access in public buildings and must be consulted when applicable. Areas of interest may include degree of slope, clearance, and supporting structures such as grab bars.
- ▲ Shower grab bars must be anchored in the structure or solid blocking behind KERDI-BOARD.
- ▲ When KERDI-SHOWER-ST/-L/-LS tray dimensions do not match the dimensions of the shower compartment, the tray may be cut or extended with dry pack mortar.
- ▲ When KERDI or KERDI-BOARD and tile are installed on the ceiling, the solid backing and fasteners must be able to support the load of the tile and setting and grouting materials.
- ▲ A water test is strongly recommended before setting tile to verify a successful installation. Wait 24 hours minimum after the membrane installation is complete to allow for final set of thin-set mortar and ensure waterproof performance at seams and connections. Refer to local plumbing codes for any specific requirements in your area. For curbless showers a temporary dam (e.g., a 2x4 and silicone sealant, plastic sheeting and sand, etc.) must be provided at the threshold to perform the water test.
- ▲ Schluter®-Systems profiles may be used to finish and protect outside corners and eliminate the use of sealant at inside corners; see page 36.
- ▲ Schluter®-SHOWERPROFILE-S/-R profiles eliminate the need for cutting wedges of tile by covering the exposed wall area where the floor slopes to KERDI-LINE.

STEAM SHOWER ASSEMBLY

Intermittent Use Steam Showers – Ceramic or stone tile

Schluter®-KERDI waterproofing membrane or
Schluter®-KERDI-BOARD waterproof building panel

K-SSH-18

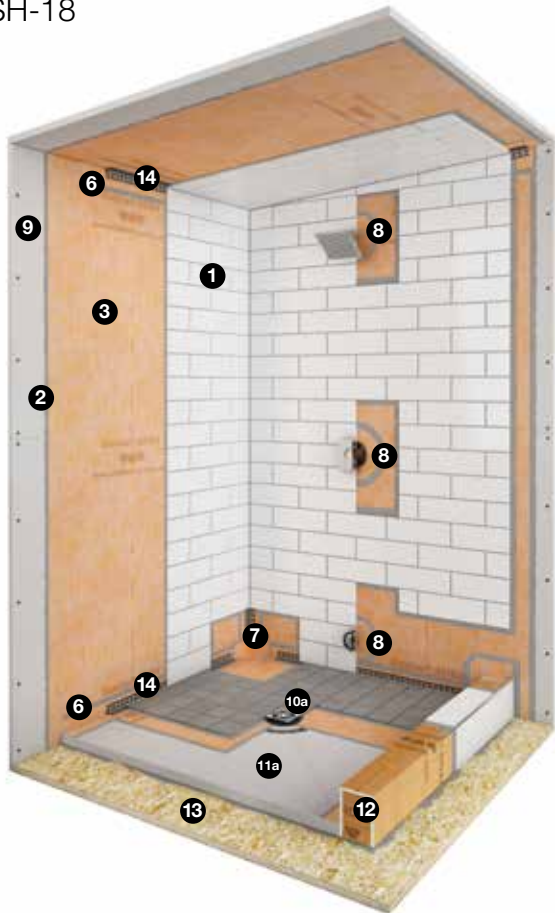

- 1 Ceramic or stone tile
- 2 Schluter SET™, Schluter ALL-SET™, Schluter FAST-SET™ or unmodified thin-set mortar
- 3 Schluter®-KERDI waterproofing membrane
- 4 Schluter®-KERDI-BOARD waterproof building panel
- 5 Schluter®-KERDI-BOARD-ZT washers
- 6 Schluter®-KERDI-BAND waterproofing strips
- 7 Schluter®-KERDI-KERECK-F waterproofing corners
- 8 Schluter®-KERDI-SEAL-PS/-MV seals or Schluter®-KERDI-FIX sealant and bonding compound
- 9 Solid backing
- 10 Drain:
 - a. Schluter®-KERDI-DRAIN
 - b. Schluter®-KERDI-LINE
- 11 Base:
 - a. Schluter®-KERDI-SHOWER-ST
 - b. Schluter®-KERDI-SHOWER-L/-LS

Alternative (not shown):

 - Mortar bed
- 12 Schluter®-KERDI-BOARD-SC curb

Alternatives (not shown):

 - Schluter®-KERDI-SHOWER-SC curb
 - Schluter®-KERDI-BOARD waterproofing panel
 - Built-up curb
- 13 Wood or concrete subfloor
- 14 Schluter®-DILEX profile (optional)

Bench (not shown):

- Schluter®-KERDI-BOARD-SB bench (optional)
- Schluter®-KERDI-SHOWER-SB bench (optional)
- Schluter®-KERDI-BOARD bench (optional)

Niche (not shown):

- Schluter®-KERDI-BOARD-SN niche (optional)

Schluter®-KERDI waterproofing membrane or Schluter®-KERDI-BOARD waterproof building panel

K-SSH-18

Areas of Application

- ▲ Interior intermittent use steam showers (e.g., residential applications).
- ▲ Over wood or concrete subfloors. See the Base information under Requirements (below) for details.
- ▲ Areas requiring disabled access/curbless applications; see detail K-SHBF on page 12.

Limitations

- ▲ Not intended for continuous use steam rooms (e.g., applications in spas, fitness centers, etc.); see detail K-SR on page 16.
- ▲ Certain glass tiles may not be compatible with bonded waterproof membranes and/or may require special setting materials. Consult glass tile manufacturer and Schluter®-Systems for more information.
- ▲ Certain moisture sensitive stones, e.g., green marble, or resin-backed tiles may not be appropriate for use in wet areas such as steam showers or may require special setting materials. Consult stone supplier and Schluter®-Systems for more information.
- ▲ Do not use sawn lumber curbs on concrete subfloors subject to moisture migration.

Requirements

- ▲ Plywood, OSB, or concrete subfloor must be clean, even, and load bearing.
- ▲ Provide insulation in wall and ceiling cavities to reduce moisture condensation on the tiled surface.
- ▲ Base – KERDI-SHOWER-ST/-L/-LS or Portland cement mortar bed
- ▲ Curb – KERDI-BOARD-SC, KERDI-SHOWER-SC, KERDI-BOARD, concrete, masonry block, or sawn lumber sheathed with solid backing (see below).
- ▲ Bench – KERDI-BOARD-SB, KERDI-SHOWER-SB, KERDI-BOARD, concrete, masonry block, or sawn lumber sheathed with solid backing (see below).
- ▲ Solid backing – gypsum wallboard, cementitious backer unit, fiber-cement underlayment, fiber-reinforced water-resistant gypsum backerboard/underlayment, coated glass mat water-resistant gypsum backerboard, Portland cement mortar bed, concrete, or masonry.
- ▲ KERDI-DRAIN/-LINE shall be properly supported.
- ▲ KERDI-DRAIN/-LINE shall be connected to the waste line; use ABS cement for ABS drains, PVC cement for PVC drains, a no-hub coupling for stainless steel drains with no-hub outlets, and thread sealing compound or tape for stainless steel drains with threaded outlets.
- ▲ Slope ceilings 2" (50 mm) per foot minimum to avoid condensation from dripping onto occupants (may be sloped to center to minimize rundown on walls).
- ▲ Install KERDI waterproofing membrane on base and curb and KERDI-BOARD waterproof building panel or KERDI waterproofing membrane on walls and ceiling. For enclosed areas, also install on door jamps, door header and past the door frame gasket, as applicable.
- ▲ Minimum KERDI-BOARD thickness – 1/2" (12.5 mm) for studs spaced at 16" (40.6 cm) o.c. and 3/4" (19 mm) for studs spaced at 24" (61.0 cm) o.c.
- ▲ KERDI-BOARD shall be fastened to wood or metal framing with appropriate screws (i.e., coarse thread wood screw for wood studs and self-tapping for metal studs) and corresponding KERDI-BOARD-ZT washers. Screws must reach a depth of at least 3/4" (20 mm) in wood studs and 3/8" (10 mm) in metal studs. Maximum allowable on-center fastener spacing is 12" (30 cm) for walls and 6" (15 cm) for ceilings.
- ▲ Any protrusions through the KERDI or KERDI-BOARD (e.g., steam inlets, lights, etc.) must be treated with KERDI-SEAL-PS/-MV seals, room temperature vulcanizing sealant or other suitable sealant with a working temperature over 250 - 300 deg F (120 - 150 deg C).
- ▲ When using the stainless steel KERDI-DRAIN bonding flange, use KERDI-FIX to bond KERDI to the integrated bonding flange.

- ▲ Movement joints shall be provided at all changes in plane, including floor/wall, wall/wall, and wall/ceiling transitions. Schluter®-Systems prefabricated movement joint profiles (e.g., DILEX-EKE) provide a maintenance-free alternative to sealant; see page 36.
- ▲ All horizontal surfaces (e.g., benches, curbs, window sills, shelves, etc.) must be sloped toward the shower drain. This can be done by sloping the substrate or the tile.

Substrate Preparation

- ▲ Verify that subfloor panels are properly fastened to framing members.
- ▲ Any leveling of the subfloor must be done prior to installing KERDI-SHOWER-ST/-L/-LS/-SB/-SC/-SR and KERDI-BOARD-SC/-SB.

Solid Backing Materials

- ▲ Gypsum wallboard – ASTM C1396/C1396M
- ▲ Cementitious backer unit – ANSI A118.9 or ASTM C1325
- ▲ Fiber-cement underlayment – ASTM C1288
- ▲ Fiber-reinforced water-resistant gypsum backerboard/underlayment – ASTM C1278
- ▲ Coated glass mat water-resistant gypsum backerboard – ASTM C1178
- ▲ Portland cement mortar – ANSI A108.1B
- ▲ Concrete
- ▲ Masonry

Setting and Grouting Materials

- ▲ Unmodified thin-set mortar – ANSI A118.1
- ▲ Grout – ANSI A118.3, A118.6, A118.7

Installation Specifications

- ▲ Solid backing panels – follow manufacturer's directions
- ▲ Portland cement mortar bed – ANSI A108.1B
- ▲ Tile – ANSI A108.5
- ▲ Grout – ANSI A108.6, A108.10

Other Considerations

- ▲ When KERDI-SHOWER-ST/-L/-LS tray dimensions do not match the dimensions of the shower compartment, the tray may be cut or extended with dry pack mortar.
- ▲ Shower grab bars must be anchored in the structure or solid blocking behind KERDI-BOARD.
- ▲ When KERDI and tile are installed on the ceiling, the solid backing and fasteners must be able to support the load of the tile and setting and grouting materials. When KERDI-BOARD and tile are installed on the ceiling, the fasteners must be able to support the load of the tile and setting and grouting materials.
- ▲ A water test is strongly recommended before setting tile to verify a successful installation. Wait 24 hours minimum after the membrane installation is complete to allow for final set of thin-set mortar and ensure waterproof performance at seams and connections. Refer to local plumbing codes for any specific requirements in your area.
- ▲ Schluter®-Systems profiles may be used to finish and protect outside corners and eliminate the use of sealant at inside corners; see page 36.
- ▲ Schluter®-SHOWERPROFILE-S/-R profiles eliminate the need for cutting wedges of tile by covering the exposed wall area where the floor slopes to KERDI-LINE.

STEAM ROOM ASSEMBLY

Continuous Use Steam Rooms – Ceramic or stone tile

Schluter®-KERDI-DS waterproofing membrane

K-SR-18



1 Ceramic or stone tile

2 Schluter SET™, Schluter ALL-SET™, Schluter FAST-SET™ or unmodified thin-set mortar

3 Schluter®-KERDI-DS waterproofing membrane

4 Schluter®-KERDI-BAND waterproofing strips

5 Schluter®-KERDI-KERECK-F waterproofing corners

6 Schluter®-KERDI-SEAL-PS seals or Schluter®-KERDI-FIX sealant and bonding compound

7 Solid backing

8 Schluter®-KERDI-DRAIN

Alternative (not shown):

- Schluter®-KERDI-LINE

9 Mortar bed

10 Schluter®-KERDI-BOARD-SC curb

Alternatives (not shown):

- Schluter®-KERDI-SHOWER-SC curb
- Schluter®-KERDI-BOARD waterproofing panel
- Built-up curb

11 Schluter®-KERDI-BOARD bench (optional)

Alternative (not shown):

- Schluter®-KERDI-BOARD-SB bench (optional)
- Schluter®-KERDI-SHOWER-SB bench (optional)

12 Wood or concrete subfloor

13 Schluter®-DILEX profile (optional)

Schluter®-KERDI-DS waterproofing membrane

K-SR-18

Areas of Application

- ▲ Interior continuous use steam rooms (e.g., applications in spas, fitness centers, etc.).
- ▲ Over wood or concrete subfloors. See the Base information under Requirements (below) for details.
- ▲ Areas requiring disabled access/curbless applications; see detail K-SHBF on page 12.

Limitations

- ▲ Certain glass tiles may not be compatible with bonded waterproof membranes and/or may require special setting materials. Consult glass tile manufacturer and Schluter®-Systems for more information.
- ▲ Certain moisture sensitive stones, e.g., green marble, or resin-backed tiles may not be appropriate for use in wet areas such as steam showers or may require special setting materials. Consult stone supplier and Schluter®-Systems for more information.
- ▲ When KERDI-BOARD is used, steam room must be operated in a manner such that the maximum service temperature of KERDI-BOARD 158°F (70 °C) is not exceeded.
- ▲ Gypsum-based solid backing panels shall be limited in use to intermittent use steam showers (e.g., residential applications)
- ▲ Do not use sawn lumber curbs on concrete subfloors subject to moisture migration.

Requirements

- ▲ Plywood, OSB, or concrete subfloor must be clean, even, and load bearing.
- ▲ Provide insulation in wall and ceiling cavities to reduce moisture condensation on the tiled surface.
- ▲ Solid backing – KERDI-BOARD, cementitious backer unit, fiber-cement underlayment, Portland cement mortar bed, concrete, or masonry.
- ▲ Base – Portland cement mortar bed.
- ▲ Curb – KERDI-BOARD-SC, KERDI-SHOWER-SC, KERDI-BOARD, concrete, masonry block, or sawn lumber sheathed with solid backing (see above).
- ▲ Bench – KERDI-BOARD, KERDI-SHOWER-SB, KERDI-BOARD-SB, concrete, masonry block, or sawn lumber sheathed with solid backing (see above).
- ▲ KERDI-DRAIN/-LINE shall be properly supported.
- ▲ KERDI-DRAIN/-LINE shall be connected to the waste line; use ABS cement for ABS drains, PVC cement for PVC drains, a no-hub coupling for stainless steel drains with no-hub outlets, and thread sealing compound or tape for stainless steel drains with threaded outlets.
- ▲ Slope ceilings 2" (50 mm) per foot minimum to avoid condensation from dripping onto occupants (may be sloped to center to minimize rundown on walls).
- ▲ Minimum KERDI-BOARD thickness – 1/2" (12.5 mm) for studs spaced at 16" (40.6 cm) o.c. and 3/4" (19 mm) for studs spaced at 24" (61.0 cm) o.c.
- ▲ KERDI-BOARD shall be fastened to wood or metal framing with appropriate screws (i.e., coarse thread wood screw for wood studs and self-tapping for metal studs) and corresponding KERDI-BOARD-ZT washers. Screws must reach a depth of at least 3/4" (20 mm) in wood studs and 3/8" (10 mm) in metal studs. Maximum allowable on-center fastener spacing is 12" (30 cm) for walls and 6" (15 cm) for ceilings.
- ▲ Install KERDI-DS waterproofing membrane on all surfaces, including the ceiling. For enclosed areas, also install on door jambs, door header and past the door frame gasket, as applicable.
- ▲ Any protrusions through the KERDI-DS membrane (e.g., steam inlets, lights, etc.) must be treated with KERDI-SEAL-PS, room temperature vulcanizing sealant or other suitable sealant with a working temperature over 250 - 300 deg F (120 - 150 deg C).
- ▲ When using the stainless steel KERDI-DRAIN bonding flange, use KERDI-FIX to bond KERDI-DS to the drain.
- ▲ Movement joints shall be provided at all changes in plane, including floor/wall, wall/wall, and wall/ceiling transitions. Schluter®-Systems prefabricated movement joint profiles (e.g., DILEX-EKE) provide a maintenance-free alternative to sealant; see page 36.

- ▲ All horizontal surfaces (e.g., benches, curbs, window sills, shelves, etc.) must be sloped toward the shower drain. This can be done by sloping the substrate or the tile.

Substrate Preparation

- ▲ Verify that subfloor panels and solid backing are properly fastened to framing members.
- ▲ Any leveling of the subfloor must be done prior to installing KERDI-SHOWER-SB/-SC/-SR and KERDI-BOARD-SC/-SB.

Solid Backing Materials

- ▲ KERDI-BOARD
- ▲ Cementitious backer unit – ANSI A118.9 or ASTM C1325
- ▲ Fiber-cement underlayment – ASTM C1288
- ▲ Portland cement mortar – ANSI A108.1B
- ▲ Concrete
- ▲ Masonry

Setting and Grouting Materials

- ▲ Unmodified thin-set mortar – ANSI A118.1
- ▲ Grout – ANSI A118.3, A118.6, A118.7

Installation Specifications

- ▲ Solid backing panels – follow manufacturer's directions
- ▲ Portland cement mortar bed – ANSI A108.1B
- ▲ Tile – ANSI A108.5
- ▲ Grout – ANSI A108.6, A108.10

Other Considerations

- ▲ Shower grab bars must be anchored in the structure or solid blocking behind KERDI-BOARD.
- ▲ When KERDI-DS and tile are installed on the ceiling, the solid backing and fasteners must be able to support the load of the tile and setting and grouting materials.
- ▲ A water test is strongly recommended before setting tile to verify a successful installation. Wait 24 hours minimum after the membrane installation is complete to allow for final set of thin-set mortar and ensure waterproof performance at seams and connections. Refer to local plumbing codes for any specific requirements in your area.
- ▲ Schluter®-Systems profiles may be used to finish and protect outside corners and eliminate the use of sealant at inside corners; see page 36.
- ▲ Schluter®-SHOWERPROFILE-S/-R profiles eliminate the need for cutting wedges of tile by covering the exposed wall area where the floor slopes to KERDI-LINE.

BATHTUB SURROUND

Bathtub Surround – Ceramic or stone tile

Schluter®-KERDI waterproofing membrane or
Schluter®-KERDI-BOARD waterproof building panel

K-TS-18



1 Ceramic or stone tile

2 Schluter SET™, Schluter ALL-SET™, Schluter FAST-SET™ or unmodified thin-set mortar

3 Waterproofing:

a. Schluter®-KERDI waterproofing membrane

b. Schluter®-KERDI-BOARD waterproof building panel

4 Schluter®-KERDI-BOARD-ZT washers

5 Schluter®-KERDI-BAND waterproofing strips

6 Schluter®-KERDI-KERECK-F waterproofing corners

7 Schluter®-KERDI-SEAL-PS/-MV seals or Schluter®-KERDI-FIX sealant and bonding compound

8 Schluter®-KERDI-FIX sealant and bonding compound

9 Solid backing

10 Schluter®-DILEX profile (optional)

Niche (not shown):

- Schluter®-KERDI-BOARD-SN niche (optional)

Schluter®-KERDI waterproofing membrane or Schluter®-KERDI-BOARD waterproof building panel

K-TS-18

Areas of Application

- ▲ Interior bathtub surrounds.

Limitations

- ▲ Certain glass tiles may not be compatible with bonded waterproof membranes and/or may require special setting materials. Consult glass tile manufacturer and Schluter®-Systems for more information.
- ▲ Certain moisture sensitive stones, e.g., green marble, or resin-backed tiles may not be appropriate for use in wet areas such as bathtub surrounds or may require special setting materials. Consult stone supplier and Schluter®-Systems for more information.

Requirements

- ▲ Solid backing – gypsum wallboard, cementitious backer unit, fiber-cement underlayment, fiber-reinforced water-resistant gypsum backerboard/underlayment, coated glass mat water-resistant gypsum backerboard, Portland cement mortar bed, concrete, or masonry.
- ▲ Solid backing panels or KERDI-BOARD shall either be installed flush with the tub flange or over the tub flange leaving a minimum space of 1/4" (6 mm) between the board and the tub deck.
- ▲ Minimum KERDI-BOARD thickness – 1/2" (12.5 mm) for studs spaced at 16" (40.6 cm) o.c. and 3/4" (19 mm) for studs spaced at 24" (61 cm) o.c.
- ▲ KERDI-BOARD shall be fastened to wood or metal framing with appropriate screws (i.e., coarse thread wood screw for wood studs and self-tapping for metal studs) and corresponding KERDI-BOARD-ZT washers. Screws must reach a depth of at least 3/4" (20 mm) in wood studs and 3/8" (10 mm) in metal studs. Maximum allowable on-center fastener spacing is 12" (30 cm) for walls and 6" (15 cm) for ceilings.
- ▲ KERDI waterproofing membrane or KERDI-BOARD waterproof building panel shall be installed up to the height of the showerhead at minimum.
- ▲ In enclosed shower areas, install KERDI or KERDI-BOARD on all surfaces, including the ceiling, door jambs and the door header.
- ▲ Any protrusions through the KERDI membrane or KERDI-BOARD panel (e.g., showerhead, mixing valve, etc.) must be treated with KERDI-SEAL-PS/-MV seals, KERDI-FIX or suitable sealant.
- ▲ All horizontal surfaces (e.g., window sills, shelves, etc.) must be sloped toward the bathtub drain. This can be done by sloping the substrate or the tile.

Substrate Preparation

- ▲ When using KERDI waterproofing membrane, verify that solid backing is properly fastened to framing members.

Solid Backing Materials

- ▲ Gypsum wallboard – ASTM C1396/C1396M
- ▲ Cementitious backer unit – ANSI A118.9 or ASTM C1325
- ▲ Fiber-cement underlayment – ASTM C1288
- ▲ Fiber-reinforced water-resistant gypsum backerboard/underlayment – ASTM C1278
- ▲ Coated glass mat water-resistant gypsum backerboard – ASTM C1178
- ▲ Portland cement mortar – ANSI A108.1B
- ▲ Concrete
- ▲ Masonry

Setting and Grouting Materials

- ▲ Unmodified thin-set mortar – ANSI A118.1
- ▲ Grout – ANSI A118.3, A118.6, or A118.7

Installation Specifications

- ▲ Solid backing panels – follow manufacturer's instructions
- ▲ Portland cement mortar bed – ANSI A108.1B
- ▲ Tile – ANSI A108.5
- ▲ Grout – ANSI A108.6, A108.10

Other Considerations

- ▲ When KERDI or KERDI-BOARD and tile are installed on the ceiling, the solid backing and fasteners must be able to support the load of the tile and setting and grouting materials.
- ▲ Shower grab bars must be anchored in the structure or solid blocking behind KERDI-BOARD.
- ▲ Schluter®-Systems profiles may be used to finish and protect outside corners and eliminate the use of sealant at inside corners; see page 36.

INSTALLATION

Walls and Ceilings

Please refer to Schluter®-Systems' installation videos in addition to reading the instructions below.

Shower walls may be made waterproof using KERDI/KERDI-DS or KERDI-BOARD prior to construction of the shower base. The waterproofing is carried to the height of the showerhead (at minimum). KERDI or KERDI-BOARD application on ceiling is optional for showers. For continuous-use steam rooms, KERDI-DS is applied to walls and ceilings. For intermittent use steam showers, KERDI or KERDI-BOARD is applied to walls and ceilings.

Schluter®-KERDI or Schluter®-KERDI-DS over solid backing

The thin-set mortar used for bonding KERDI/KERDI-DS to walls and ceilings must be appropriate for the substrate and must penetrate and engage the membrane fleece. The mortar must be mixed to a fairly fluid consistency, but still able to hold a notch.



1 Clean any dust or other debris from the surface of the solid backing. Dampen particularly dry and porous substrates in order to help prevent premature drying or skinning of the thin-set mortar.



2 Apply Schluter SET™, ALL-SET™, FAST-SET™, or unmodified thin-set mortar using a 1/4" x 3/16" (6 mm x 5 mm) V-notched trowel or the KERDI-TROWEL. Embed KERDI or KERDI-DS in the mortar and work the membrane onto the entire surface to ensure full coverage and remove air pockets.



3 Seams in the membrane are constructed by overlapping the edges by 2" (50 mm) or by abutting adjacent sheets and installing KERDI-BAND, centered over the joint. Any protrusions through the membrane (e.g., mixing valve, shower head, etc.) must be sealed with KERDI-SEAL-PS/-MV, KERDI-FIX, or other suitable sealant.

Schluter®-KERDI-BOARD over wood or metal framing

Grab bars, wall-mounted toilets, or other heavy objects must be anchored in the structure or solid blocking behind KERDI-BOARD. Installation instructions for other applications of KERDI-BOARD (e.g. fully embedded or spot-bonded over solid backing) can be found in the 12.1 Schluter®-KERDI-BOARD technical data sheet.



1 KERDI-BOARD can be mounted vertically or horizontally on framing with appropriate screws (i.e., coarse thread wood screw for wood studs and self-tapping for metal studs) and corresponding KERDI-BOARD-ZT washers. Minimum board thickness = 1/2" (12.5 mm) for studs spaced at 16" (40.6 cm) o.c.; 3/4" (19 mm) for studs spaced at 24" (61.0 cm) o.c. Screws must reach a depth of at least 3/4" (20 mm) in wood studs and at least 3/8" (10 mm) in metal studs.



2 Abut panels over the center of the studs. Screws may be placed between adjacent panels such that the washers fasten both panel edges. The maximum allowable on-center fastener spacing is 12" (30 cm) for walls and 6" (15 cm) for ceilings.

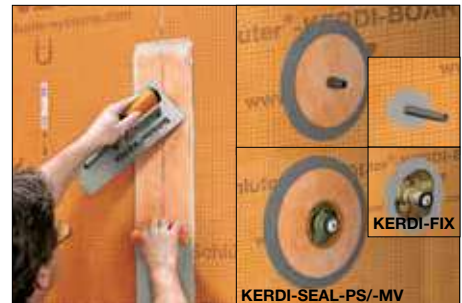

3 KERDI-BOARD joints, corners, and fastener penetrations are sealed with KERDI-BAND and KERDI-KERECK corners, ensuring a minimum 2" (50 mm) overlap. Apply Schluter SET™, ALL-SET™, FAST-SET™, or unmodified thin-set mortar using a 1/4" x 3/16" (6 mm x 5 mm) V-notched trowel or the KERDI-TROWEL. Embed KERDI-BAND/-KERECK in the mortar and work the membrane onto the surface to ensure full coverage and remove air pockets. Any protrusions through the panel (e.g., mixing valve, shower head, etc.) must be sealed with KERDI-SEAL-PS/-MV, KERDI-FIX, or other suitable sealant.

INSTALLATION

Schluter®-KERDI-BOARD-SN Shower Niche

Please refer to Schluter®-Systems' installation videos in addition to reading the instructions below.

The exact order of installation can vary from that shown below, provided all fastening and waterproofing measures are performed properly. The following represents Schluter®-Systems' recommendations for simple and reliable installation.

Schluter®-KERDI over solid backing



- 1 Determine desired location and trace around the outside of the KERDI-BOARD-SN flange, making sure the lines are level and plumb. Cut and remove the wallboard such that the niche will be supported on both sides by the studs or other wall framing.

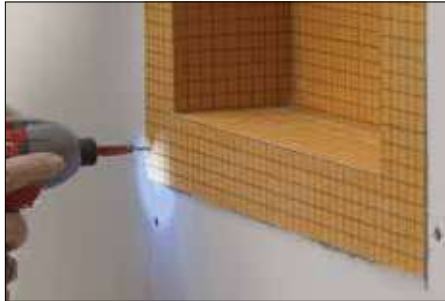

- 2 Insert the niche and fasten to the studs using wood or metal screws, placing the fasteners approximately 1/4" (6 mm) from the edges of the niche. Fasten all corners and limit fastener spacing to 12" (30 cm) o.c.

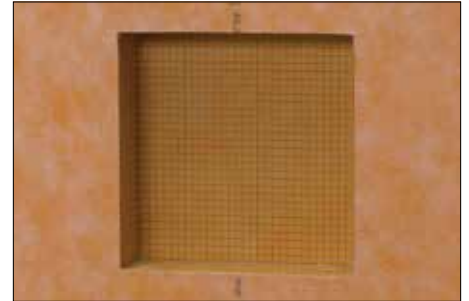

- 3 Apply the KERDI membrane over the wall surface as described on page 20. Once the membrane is solidly embedded, cut the membrane to match the niche opening.

Schluter®-KERDI-BOARD over wood or metal framing



- 1 Determine desired location and trace around the outside of the KERDI-BOARD-SN flange, making sure the lines are level and plumb. Cut and remove the KERDI-BOARD such that the niche will be supported on both sides by the studs or other wall framing.

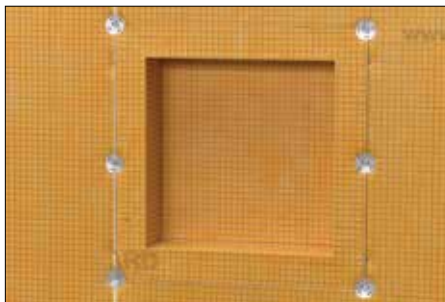

- 2 Insert the niche and fasten to the studs using wood or metal screws and KERDI-BOARD-ZT washers, placing the fasteners along the seam between the KERDI-BOARD and the niche. Fasten all corners and limit fastener spacing to 12" (30 cm) o.c.

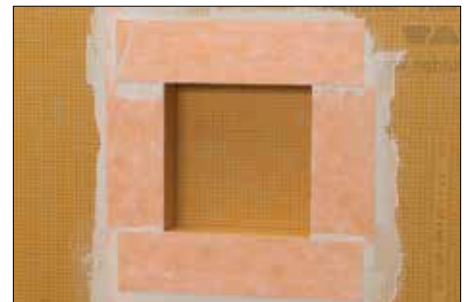

- 3 Seal the seams between the niche and walls using KERDI-BAND with Schluter SET™, ALL-SET™, FAST-SET™, or unmodified thin-set mortar ensuring a 2" (50 mm) overlap in all directions.

Note: When using the prefabricated shelf, determine the desired height of the shelf and mark with a level line. Set tile up to that line on the back and sides of the niche. Butter the sides and back of the shelf with Schluter SET™, ALL-SET™, FAST-SET™, or unmodified thin-set mortar and solidly embed it in the niche, resting on the previously installed tile. The shelf may be raised at the back to create a slope, or the tile may be set on a slope, to prevent water from pooling in the finished application.

INSTALLATION

Shower Base with Schluter®-KERDI-DRAIN

Please refer to Schluter®-Systems' installation videos in addition to reading the instructions below.

Preparation

Locate and cut a hole in the substrate for the drain outlet and coupling to the waste line using the template provided. Limit the diameter of the hole to 5" (125 mm) maximum to ensure proper support for the tile assembly.

Note: Fill in box-outs in concrete floors with dry-pack mortar or concrete. A pipe coupling or similar can be used as a form around the waste line.

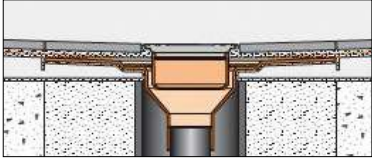

Schluter®-KERDI-DRAIN with Schluter®-KERDI-SHOWER-ST prefabricated shower tray

The substrate must be clean, even, and load bearing. Any leveling must be done prior to shower tray installation. If necessary, cut the tray to size prior to application; ideally, the tray is cut equally on all sides to ensure a consistent perimeter height. The base can also be extended beyond the tray using dry-pack mortar.

Plumbing Access: If there is access to the plumbing from below and the waste line can be connected after installing KERDI-DRAIN, the tray can be installed prior to the drain.



1 Apply Schluter SET™, ALL-SET™, FAST-SET™, or unmodified thin-set mortar to the substrate using a 1/4" x 3/8" (6 mm x 10 mm) square- or U-notched trowel. **Note:** The thin-set mortar used in this step is to bed and support the tray only.



2 Place the KERDI-SHOWER-ST tray and solidly embed in the mortar. Check the underside of the tray to ensure full coverage and support are achieved.



3 Completely fill the step in the shower tray with thin-set mortar. Press KERDI-DRAIN firmly into the mortar to ensure full support of the bonding flange.

No Plumbing Access: When there is no access to the plumbing from below, KERDI-DRAIN is installed to the appropriate height and connected to the waste line prior to the installation of the shower tray.



1 Begin by dry-fitting the components. Measure and cut a section of pipe to connect KERDI-DRAIN to the odor trap using the detachable center section of the tray or foam spacers included with the drain as a spacer. Prepare the odor trap, pipe, and KERDI-DRAIN with cleaner, primer and ABS or PVC cement per the solvent cement manufacturer's instructions and connect.



2 Apply Schluter SET™, ALL-SET™, FAST-SET™, or unmodified thin-set mortar to the substrate and to the top and bottom of the detached center section of the KERDI-SHOWER-ST tray. Slide the center section into place below the drain to ensure solid and uniform support of the bonding flange.



3 Apply Schluter SET™, ALL-SET™, FAST-SET™, or unmodified thin-set mortar to the substrate using a 1/4" x 3/8" (6 mm x 10 mm) square- or U-notched trowel. Place the KERDI-SHOWER-ST tray and solidly embed in the mortar. Check the underside of the tray to ensure full coverage and support are achieved.

Clamping Ring Drain Installed: If a clamping ring drain is installed, replace with KERDI-DRAIN or convert using the KERDI-DRAIN adaptor kit.



1 Remove the clamping ring from the installed drain and save the bolts. Align the bolt pattern of the clamping ring with the adaptor ring and punch the matching inserts through the adaptor ring.



2 Apply a 1/4" - 3/8" (6 mm - 10 mm) bead of KERDI-FIX to the installed drain flange. Place the adaptor ring on the installed drain, re-insert the bolts, and tighten evenly. Make bolts finger-tight plus 1/4 turn; over tightening may warp the ring and result in leaks.



3 Slide the adaptor flange into the adaptor ring and ensure full support underneath with mortar or the detachable center section of the foam tray. Depending on the installed drain elevation, it may be necessary to install a polystyrene foam panel, tile backerboard, etc. prior to the tray. Install the tray as per the instructions on page 22.

Note: Schluter®-Systems strongly recommends a leak test be performed on the connection between the drain and the waste line prior to continuing with the remainder of the installation whenever possible. Refer to local plumbing and/or building codes for any specific requirements in your area.

Schluter®-KERDI-DRAIN with mortar bed

Plumbing Access: If there is access to the plumbing from below and the waste line can be connected after installing KERDI-DRAIN, the drain can be installed in conjunction with the mortar bed.



1 Place a ring of loose mortar up to the inlet hole in the floor and firmly press the drain into the mortar and level. The bonding flange must be fully supported to prevent damage to the tile assembly (e.g., cracked grout around drain). When installing KERDI-DRAIN over wood substrates, the minimum thickness of mortar required at the perimeter of the bonding flange is 1" (25 mm).



2 The screed is then placed flush with the top of the bonding flange of the KERDI-DRAIN. Slope the mortar bed at 1/4" (6 mm) per 12" (305 mm) using the bonding flange and a perimeter screed as guides.

No Plumbing Access: When there is no access to the plumbing from below, KERDI-DRAIN is installed to the appropriate height and connected to the waste line prior to the installation of the shower base.

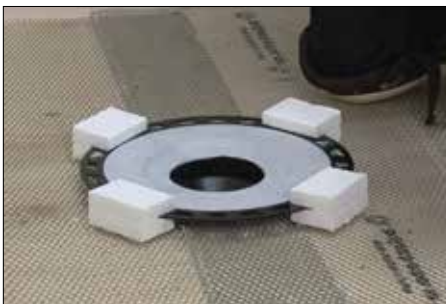

1 Measure and cut a section of pipe to connect KERDI-DRAIN to the odor trap using the foam spacers included with the drain as a spacer. When installing KERDI-DRAIN over wood substrates, the minimum thickness of mortar required at the perimeter of the bonding flange is 1" (25 mm). Prepare the odor trap, cut section of pipe, and KERDI-DRAIN with cleaner, primer and ABS or PVC cement per the solvent cement manufacturer's instructions and connect.



2 Pack loose mortar under the drain up to the inlet hole to ensure solid and uniform support of the bonding flange and level. The mortar bed is then placed according to the instructions above.

Clamping Ring Drain Installed: If a clamping ring drain is installed, replace with KERDI-DRAIN or convert using the KERDI-DRAIN adaptor kit.



1 Remove the clamping ring from the installed drain and save the bolts. Align the bolt pattern of the clamping ring with the adaptor ring and punch the matching inserts through the adaptor ring.



2 Apply a 1/4" - 3/8" (6 mm - 10 mm) bead of KERDI-FIX to the installed drain flange. Place the adaptor ring on the installed drain, re-insert the bolts, and tighten evenly. Make bolts finger-tight plus 1/4 turn; over tightening may warp the ring and result in leaks.



3 Slide the adaptor flange into the adaptor ring and ensure full support under the adaptor flange with mortar. The mortar bed is then placed according to the instructions on page 25.

Note: Schluter®-Systems strongly recommends a leak test be performed on the connection between the drain and the waste line prior to continuing with the remainder of the installation whenever possible. Refer to local plumbing and/or building codes for any specific requirements in your area.

Schluter®-KERDI-BOARD-SB bench



1 Apply Schluter SET™, ALL-SET™, FAST-SET™, or unmodified thin-set mortar to the floor and walls using a 1/4" x 3/8" (6 mm x 10 mm) square- or U-notched trowel.



2 Press the bench firmly into place and check the underside and backsides to ensure that full coverage and support are achieved. Verify that the slope on the surface of the bench is directed toward the shower base.



3 Install KERDI-BAND and KERDI-KERECK and KERDI-KERS-B (for triangular bench) to cover all seams and corners, ensuring a minimum 2" (50 mm) overlap, and work the membrane into the mortar to achieve full coverage and remove air pockets.

Schluter®-KERDI-BOARD-SC curb and Schluter®-KERDI-SHOWER-SC/-SR curb or ramp

If necessary, cut the KERDI-BOARD-SC to length using a utility knife and KERDI-SHOWER-SC/-SR using a handsaw.



1 Apply Schluter SET™, ALL-SET™, FAST-SET™, or unmodified thin-set mortar to the floor and to the edge of the shower base and walls using a 1/4" x 3/8" (6 mm x 10 mm) square- or U-notched trowel.



2 Press the curb or ramp firmly into place. Check the underside of the curb or ramp to ensure that full coverage and support is achieved. **Note:** When setting tile on the curb, the surface must be sloped towards the shower drain.



Note: Schluter®-KERDI-BOARD can be used to build custom curbs.

Waterproofing the shower base

The KERDI or KERDI-DS waterproofing membranes can be installed over the KERDI-SHOWER-ST tray immediately or over a mortar bed as soon as the mortar bed can be walked upon using Schluter SET™, ALL-SET™, FAST-SET™, or unmodified thin-set mortar. A pre-cut section of KERDI matching the dimensions of the tray is included with the KERDI-SHOWER-ST for convenience. The thin-set mortar must be mixed to a fairly fluid consistency, but still able to hold a notch.



- 1 Apply Schluter SET™, ALL-SET™, FAST-SET™, or unmodified thin-set mortar to the bonding flange and surrounding shower base with a 1/4" x 3/16" (6 mm x 5 mm) V-notched trowel or the KERDI-TROWEL. **Note:** When using the stainless steel drain, the membrane is adhered to the bonding flange with **KERDI-FIX**; clean the bonding flange prior to KERDI-FIX application.



- 2 Embed KERDI or KERDI-DS in the bond coat and work the membrane onto the KERDI-DRAIN bonding flange and shower base to ensure full coverage and remove air pockets. The membrane is carried to the step in the bonding flange (template provided) and to the edges of the shower base.



- 3 When using KERDI-SHOWER-SC/-SR, repeat the process to install the membrane over the curb or ramp. Seams in the membrane are constructed by overlapping the edges by 2" (50 mm) or by abutting adjacent sheets and installing KERDI-BAND centered over the joint. Install KERDI-KERECK at all inside and outside corners. When using KERDI-BOARD-SC, seal the curb to the base and walls using KERDI-KERECK and KERDI-BAND.

Grate assembly

Grate:



- 1 Place the height adjustment collar inside the lateral adjustment ring and snap the grate into place. **Note:** For the 6" (150 mm) grates, the height adjustment collar is integrated with the grate. For the residential adaptor kit, there is no lateral adjustment ring.



- 2 Fill the step in the bonding flange with thin-set mortar and back-butter the underside of the grate to ensure full support. Place the assembly into the mortar and install the surrounding tiles, ensuring full coverage.



- 3 Position the grate to match the joint pattern of the tile covering and press flush with the tile surface. Remove all excess setting material immediately. **Note:** Protect the visible surface of the grate from contact with setting and grouting materials. In particular, anodized aluminum is sensitive to alkaline materials.

Tileable Covering Support:



- 1 Fill the step in the bonding flange with thin-set mortar. Place the tile spacer in the lateral adjustment ring and press the assembly into the mortar. Install tiles up to the tile spacer, ensuring full coverage. Embed the tiles on the integrated tabs on the lateral adjustment ring, which provide for a flush transition to the covering support. Position the tile spacer to match the joint pattern of the tile covering. The tiles may be held back from the spacer as required to match the layout. Remove all excess setting material.



- 2 Apply tile to the top of the covering support using Schluter SET™, ALL-SET™, FAST-SET™, or unmodified thin-set mortar. The tile may overhang the covering support provided that a drainage opening of at least 3/16" (5 mm) is provided.



- 3 After the tile is set and grouted, remove the tile spacer and insert the tiled covering support into the lateral adjustment ring.

INSTALLATION

Shower base with Schluter®-KERDI-LINE

Please refer to Schluter®-Systems installation videos in addition to reading the instructions below.

Preparation

Locate and cut a hole in the substrate for the drain outlet and coupling to the waste line using the template provided. Limit the diameter of the hole to 5" (125 mm) maximum to ensure proper support for the tile assembly. When installing KERDI-LINE against a wall, be sure to factor in the wall board thickness before cutting the hole in the substrate. **Note:** Fill in box-outs in concrete floors with dry-pack mortar or concrete. A pipe coupling or similar can be used as a form around the waste line.

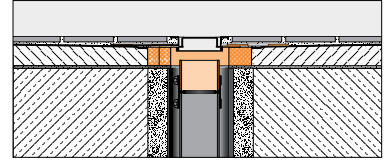

Schluter®-KERDI-LINE channel body installation

Plumbing Access: When there is access to the plumbing from below and the waste line can be connected after installing KERDI-LINE, the channel body may be set without making a connection to the waste line simultaneously.



1 Apply Schluter SET™, ALL-SET™, FAST-SET™, or unmodified thin-set mortar to the substrate where the drain is to be placed with a notched trowel and solidly embed the channel support in the mortar.



2 Apply Schluter SET™, ALL-SET™, FAST-SET™, or unmodified thin-set mortar to the top of the channel support and press the channel body firmly into the mortar, ensuring full support of the bonding flange. Check to make sure the KERDI-LINE is level.

No Plumbing Access: When there is no access to the plumbing from below, the channel body must be set and connected to the waste line simultaneously.



1 Begin the drain installation by dry fitting the components. Measure and cut a section of pipe to connect the coupling to the odor trap below the floor, using the channel support as a spacer.



2 Apply Schluter SET™, ALL-SET™, FAST-SET™, or unmodified thin-set mortar to the top of the channel support with a notched trowel and press the channel support firmly onto the underside of the channel body. Attach the mechanical coupling to the drain outlet and the cut section of the pipe per the coupling manufacturer's instructions.



3 Apply Schluter SET™, ALL-SET™, FAST-SET™, or unmodified thin-set mortar to the substrate where the drain is to be placed with a notched trowel. Prepare the cut section of pipe and odor trap with cleaner, primer and ABS or PVC cement per the solvent cement manufacturer's instructions.



4 Solidly embed the channel support and KERDI-LINE into the mortar on the floor and connect the cut section of pipe to the odor trap. Check to make sure the KERDI-LINE is level.

Note: KERDI-FIX or other adhesives that are compatible with EPS foam can be used to install the channel support and channel body as an alternative to thin-set mortar. Apply a generous bead of KERDI-FIX to the top and bottom of the channel support. The use of KERDI-FIX limits the ability to level KERDI-LINE.

Note: Schluter®-Systems strongly recommends a leak test be performed on the connection between the drain and the waste line prior to continuing with the remainder of the installation whenever possible. Refer to local plumbing and/or building codes for any specific requirements in your area.

Clamping Ring Drain Installed: If a clamping ring drain is already installed, the drain must be replaced with KERDI-LINE.

Schluter®-KERDI-LINE with Schluter®-SHOWER-L/-LS prefabricated tray



- 1 Any leveling of the floor must be done prior to the installation of the shower tray. If necessary, cut the tray to size prior to application. The shower base can also be extended beyond the tray using dry-pack mortar, which is in turn covered with the KERDI membrane.



- 2 Cut the flat end of the KERDI-SHOWER-L/-LS tray to fit around the channel support. Apply Schluter SET™, ALL-SET™, FAST-SET™, or unmodified thin-set mortar to the substrate using a 1/4" x 3/8" (6 mm x 10 mm) square- or U-notched trowel. Slide the KERDI-SHOWER-L/-LS under the edge of the channel body flush with the surface of the channel support, making certain to solidly embed the tray in the mortar. Check the underside of the tray to ensure that full coverage is achieved.
Note: The thin-set mortar used in this step is to bed and support the tray only.



Note: When KERDI-LINE is placed at an intermediate location (e.g., center of shower), it is recommended that the KERDI SHOWER-L tray be cut by equal amounts from the ends to ensure a consistent height of the first course of tile. When KERDI-LINE is placed adjacent to a wall, cut the KERDI-SHOWER-L tray from the thicker end to ensure a flush transition at the drain.

Schluter®-KERDI-LINE with mortar base



- 1 Place a mortar screed opposite the installed KERDI-LINE channel body.



- 2 Fill the remainder of the shower base with mortar and slope the mortar bed at 1/4" (6 mm) per 12" (305 mm) using the bonding flange and a perimeter screed as guides.



- 3 As soon as the mortar bed can be walked upon, waterproofing with the KERDI membrane can begin.

Schluter®-KERDI-BOARD-SB bench



- 1 Apply Schluter SET™, ALL-SET™, FAST-SET™, or unmodified thin-set mortar to the floor and walls using a 1/4" x 3/8" (6 mm x 10 mm) square- or U-notched trowel.



- 2 Press the bench firmly into place and check the underside and backsides to ensure that full coverage and support are achieved. Verify that the slope on the surface of the bench is directed toward the shower base.



- 3 Install KERDI-BAND and KERDI-KERECK and KERDI-KERS-B (for triangular bench) to cover all seams and corners, ensuring a minimum 2" (50 mm) overlap, and work the membrane into the mortar to achieve full coverage and remove air pockets.

Schluter®-KERDI-BOARD-SC curb and Schluter®-KERDI-SHOWER-SC/-SR curb or ramp

If necessary, cut the KERDI-BOARD-SC to length using a utility knife and KERDI-SHOWER-SC/-SR using a handsaw.



1 Apply Schluter SET™, ALL-SET™, FAST-SET™, or unmodified thin-set mortar to the floor and to the edge of the shower base and walls using a 1/4" x 3/8" (6 mm x 10 mm) square- or U-notched trowel.



2 Press the curb or ramp firmly into place. Check the underside of the curb or ramp to ensure that full coverage and support is achieved. **Note:** When setting tile on the curb, the surface must be sloped towards the shower drain.



Note: KERDI-BOARD can be used to build custom curbs.

Waterproofing the shower base

The KERDI-SHOWER-L/-LS trays are provided with integral waterproofing. When using a mortar bed, the shower base must be made waterproof using the KERDI or KERDI-DS waterproofing membrane. The membranes can be installed as soon as the mortar bed can be walked upon.



1 Apply Schluter SET™, ALL-SET™, FAST-SET™, or unmodified thin-set mortar to the shower base with a 1/4" x 3/16" (6 mm x 5 mm) V-notched trowel or the KERDI-TROWEL. The thin-set mortar must be mixed to a fairly fluid consistency, but still able to hold a notch.



2 Embed KERDI or KERDI-DS in the bond coat and work the membrane onto the entire surface to ensure full coverage and remove air pockets. The membrane is carried to the stainless steel bonding flange and to the edges of the shower base.



3 The KERDI collar on KERDI-LINE is integrated with the adjoining waterproofing assembly using Schluter SET™, ALL-SET™, FAST-SET™, or unmodified thin-set mortar. The KERDI collar must be cut and folded where the KERDI-LINE is installed adjacent to walls.



4 Seams in the membrane are constructed by overlapping the edges by 2" (50 mm) with Schluter SET™, ALL-SET™, FAST-SET™, or unmodified thin-set mortar or by abutting adjacent sheets and installing KERDI-BAND with unmodified thin-set mortar, centered over the joint.



5 When using KERDI-SHOWER-SC/-SR, repeat the process to install the membrane over the curb or ramp. Seams in the membrane are constructed by overlapping the edges by 2" (50 mm) or by abutting adjacent sheets and installing KERDI-BAND centered over the joint. Install KERDI-KERECK at all inside and outside corners. When using KERDI-BOARD-SC, seal the curb to the base and walls using KERDI-KERECK and KERDI-BAND.

Grate assembly

Grate



- 1 Apply Schluter SET™, ALL-SET™, FAST-SET™, or unmodified thin-set mortar to the underside of the grate frame and place it in the channel body ensuring full coverage and support of the frame. Insert the foam spacers in the grate frame to reinforce it during the remainder of the installation.



- 2 Slide the plastic height adjustment spacers with threaded bolts onto the tabs along the inside of the grate frame to adjust the elevation of the frame. The spacers may be adjusted simply by turning the bolts by hand. The elevation should be set such that the frame will be flush with the surface of the tile covering.



- 3 Install the tiles on the shower base using Schluter SET™, ALL-SET™, FAST-SET™, or unmodified thin-set mortar, ensuring full coverage. Make final adjustments to ensure the grate frame is flush with surrounding tiles. Remove foam tile spacers and plastic height adjustment spacers with threaded bolts following tile installation.

Note: Protect the visible surfaces of the grate frame and grate from contact with setting and grouting materials. Setting and grouting materials must be removed immediately.

Tileable Covering Support (Grate D)



- 1 Peel the protective foil off the cover strip and adhere the strip to the bonding flange adjacent to the wall(s). Position the strip along the edge of the channel. The cover strip hides and protects the KERDI surface under the tile installed in step 3.

When the shower base will be tiled beyond the ends of the channel, the cover strip is not required at these locations.



- 2 Insert the tile spacers into the channel body. Install the surrounding tile on the adjoining walls and shower base up to the spacers using Schluter SET™, ALL-SET™, FAST-SET™, or unmodified thin-set mortar, ensuring full coverage. Remove all excess setting material.



- 3 Tile is bonded to the covering support using Schluter SET™, ALL-SET™, FAST-SET™, or unmodified thin-set mortar. The tile is installed flush with the front side of the covering support to provide the drainage opening and overhanging the back side of the covering support to cover the bonding flange along the wall. When the ends of the channel body are located adjacent to walls, the tile is installed overhanging the end of the support to cover the bonding flange along the walls. Measure and cut the tile such that an approximate 1/16" (1 mm) gap is left at the walls.

Note: When the shower base is tiled beyond the ends of the channel, the tile on the ends of the covering support can be cut to either match the grout joints of the surrounding floor covering or to provide a perimeter drainage opening.

Tiles



- 1 Once all seams and corners have been completely sealed, the assembly is waterproofed and ready to be tiled. Apply a uniform layer of Schluter SET™, Schluter ALL-SET™, Schluter FAST-SET™, or unmodified thin-set mortar and comb using a trowel that is appropriate for the size of the tile. Be sure the trowel groves in the thin-set are all going the same direction, as shown in the photo above.

Note: A water test is strongly recommended before setting tile to verify a successful installation. Wait 24 hours minimum after the membrane installation is complete to allow for final set of thin-set mortar and ensure waterproof performance at seams and connections. Refer to local plumbing codes for any specific requirements in your area.



- 2 Solidly embed the tiles in the setting material, making sure to observe the open time of the bonding mortar. If the mortar skins over prior to tile installation, remove and reapply.



- 3 Periodically remove and check a tile to ensure that full coverage is being attained.

Note: Coverage may vary with mortar consistency, angle at which the trowel is held, substrate flatness, etc. If full coverage is not achieved, remove and reapply, making sure to verify proper mortar consistency and application. For large-format tiles, e.g., 12" x 12" (305 mm x 305 mm) and larger, back-buttering the tiles with a skim coat of thin-set mortar is a useful way to help ensure proper coverage. The skim coat can fill in the concave area on the back of the tile (ceramic tiles are not perfectly flat) and improve contact with the mortar combed on the substrate.

Optional Schluter®-SHOWERPROFILE-S/-R system profiles

Select SHOWERPROFILE-S according to shower base tile thickness and the height and length of the wall area to be covered. Select SHOWERPROFILE-R according to the height of the wall area to be covered.

SHOWERPROFILE-S



- 1 Measure the height of the area to be covered at the lowest point. Next, measure the length of the area and mark the profile where it is to be cut at both ends. Remove the protective foil and cut the tapered profile and support section to length.



- 2 Place the tapered profile into the support section and apply Schluter SET™, ALL-SET™, FAST-SET™, or unmodified thin-set mortar to the fleece on the back side of the profile.



- 3 Press the profile into place and align it flush with the wall tile. Immediately clean away any excess setting material. Install adjacent tiles on the shower base.

SHOWERPROFILE-R



- 1 Measure the length of the area to be covered. Remove the protective foil and cut the profile to length.



- 2 Connect the two components of SHOWERPROFILE-R to achieve the desired height. Small pieces of tape can be used to help maintain the position of the components during installation.



- 3 Apply Schluter SET™, ALL-SET™, FAST-SET™, or unmodified thin-set mortar to the fleece on the back side of the profile. Press the profile into place and align it flush with the wall tile. Immediately clean away any excess setting material.

Note: The Schluter®-PROCUT-TSM cutting wheel can be used with an angle grinder set to low speed to cut the stainless steel profiles. The SHOWERPROFILE-S support section can be cut with snips. Please read and follow all safety instructions from the grinder manufacturer to prevent injury.

Schluter®-KERDI-LINE-FC

KERDI-LINE-FC may be used with tiles that are 1/4" (6 mm) thick or greater, to connect adjacent KERDI-LINE grates A and B.

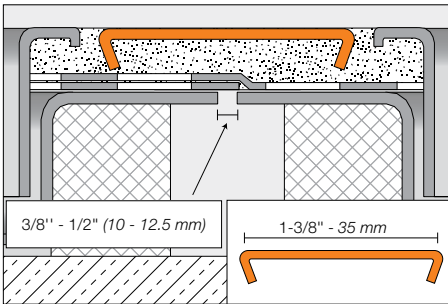

- 1 Install KERDI-LINE channel bodies end-to-end and overlap the KERDI collars using Schluter SET™, ALL-SET™, FAST-SET™, or unmodified thin-set mortar to ensure a waterproof connection.



- 2 Apply a sufficient amount of thin-set mortar to the substrate and/or the back of KERDI-LINE-FC and press the profile into the mortar until its surface is flush with the adjacent tile and grate assembly. Leave a space of approximately 1/16" – 1/8" (1.5 – 3 mm). Fill the joints completely with grout or setting material.

Schluter®-SHOWERPROFILE-WS

SHOWERPROFILE-WS can be used in conjunction with tiles that are 5/16" (8 mm) thick or greater.



- 1 Install the tile covering up to where the profile will be installed.
- 2 Apply a sufficient amount of thin-set mortar to this area and to the back of the profile to achieve full coverage. Press the profile into the mortar until its surface is flush with the tile.
- 3 Set adjacent rows of tile, leaving a space of approximately 1/16" - 1/8" (1.5 - 3 mm) between the profile and tile.
- 4 Cut the SHOWERPROFILE-WSL/-WSC insert to length and insert into the profile.

Schluter®-SHOWERPROFILE-WSK

SHOWERPROFILE-WSK is applied to the floor covering using Schluter®-KERDI-FIX, silicone, or similar adhesive. Prior to applying the adhesive, make sure the surfaces are free from any adhesion-inhibiting substances such as oil or grease.



- 1 Apply a bead of adhesive to the underside of the profile legs where contact is made with the floor, and set the profile. **Note:** End caps are used when the profile does not abut a vertical surface. Install end caps with Schluter®-KERDI-FIX, silicone, or a similar adhesive before installing the profile.
- 2 Use a suitable cleaning agent to remove any excess adhesive after placement of the profile.
- 3 Cut the SHOWERPROFILE-WSL/-WSC insert to length and insert into the profile.

INSTALLATION

Bathtub surround

Please refer to Schluter®-Systems' installation videos in addition to reading the instructions below.

The waterproofing is carried to the height of the showerhead (at minimum). KERDI or KERDI-BOARD application on ceiling is optional for bathtub surrounds.

Schluter®-KERDI over solid backing

The thin-set mortar used for bonding KERDI to walls and ceilings must be appropriate for the substrate and must penetrate and engage the membrane fleece. The mortar must be mixed to a fairly fluid consistency, but still able to hold a notch.



1 Clean any dust or other debris from the surface of the solid backing. Dampen particularly dry and porous substrates in order to help prevent premature drying or skinning of the thin-set mortar.



2 Place painter's tape to protect the tub deck. Apply Schluter SET™, ALL-SET™, FAST-SET™, or unmodified thin-set mortar to the solid backing using a 1/4" x 3/16" (6 mm x 5 mm) V-notched trowel or the KERDI-TROWEL. Completely fill the 1/4" (6 mm)-wide gap between the solid backing and tub with KERDI-FIX or other suitable sealant.
Note: When the solid backing is installed above the tub flange, apply KERDI-FIX to the tub flange and spread using a small notched trowel.



3 Apply KERDI-BAND waterproofing strips or 5" (125 mm)-wide cut sections of KERDI waterproofing membrane. Solidly embed the membrane in the mortar and KERDI-FIX to ensure full coverage and remove air pockets.



4 Apply Schluter SET™, ALL-SET™, FAST-SET™, or unmodified thin-set mortar to the solid backing and previously applied KERDI-BAND. Embed the KERDI in the thin-set mortar and work the membrane onto the entire surface to ensure full coverage and remove air pockets.



5 Seams in the membrane are constructed by overlapping the edges of KERDI by 2" (50 mm) or by abutting adjacent sheets of KERDI and installing KERDI-BAND, centered over the joint.



6 Any protrusions through the KERDI membrane (e.g., mixing valve, shower head, etc.) must be sealed with KERDI-SEAL-PS/-MV, KERDI-FIX, or other suitable sealant.

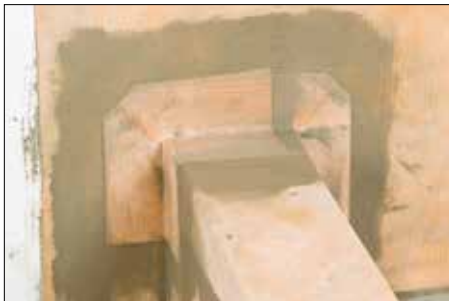

7 Seal connections to knee walls using KERDI-KERECK-F preformed corners and Schluter SET™, ALL-SET™, FAST-SET™, or unmodified thin-set mortar.

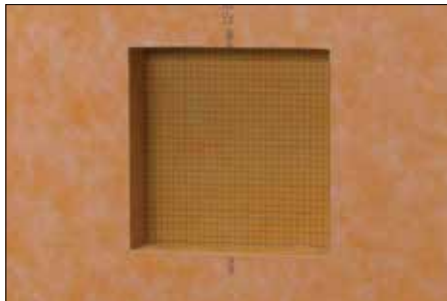

Note: See page 21 for KERDI-BOARD-SN shower niche installation instructions.



8 Once the entire membrane, including seams, corners, and knee walls have been completely bonded and, therefore, waterproofed, the assembly is ready to be tiled. For tile installation instructions, see page 29.

Schluter®-KERDI-BOARD over wood or metal framing

Grab bars or other heavy objects must be anchored in the structure or solid blocking behind KERDI-BOARD. Installation instructions for other applications of KERDI-BOARD (e.g. fully embedded or spot-bonded over solid backing) can be found in the 12.1 Schluter®-KERDI-BOARD technical data sheet.



- 1 KERDI-BOARD can be mounted vertically or horizontally on framing with appropriate screws (e.g., coarse thread wood screw for wood studs and self-tapping for metal studs) and corresponding KERDI-BOARD-ZT washers. Minimum board thickness = 1/2" (12.5 mm) for studs spaced at 16" (40.6 cm) o.c.; 3/4" (19 mm) for studs spaced at 24" (61.0 cm) o.c. Screws must reach a depth of at least 3/4" (20 mm) in wood studs and at least 3/8" (10 mm) in metal studs.



- 2 Abut panels over the center of the studs or other solid backing. Screws may be placed between adjacent panels such that the washers fasten both panel edges. The maximum allowable on-center fastener spacing is 12" (30 cm) for walls and 6" (15 cm) for ceilings.



- 3 Place painter's tape to protect the tub deck. Apply Schluter SET™, ALL-SET™, FAST-SET™, or unmodified thin-set mortar to the KERDI-BOARD using a 1/4" x 3/16" (6 mm x 5 mm) V-notched trowel or the KERDI-TROWEL. Completely fill the 1/4" (6 mm)-wide gap between the KERDI-BOARD and tub with KERDI-FIX or other suitable sealant.

Note: When KERDI-BOARD is installed above the tub flange, apply KERDI-FIX to the tub flange and spread using a small notched trowel.



- 4 Apply KERDI-BAND waterproofing strips. Solidly embed the membrane in the mortar and KERDI-FIX to ensure full coverage and remove air pockets.



- 5 KERDI-BOARD joints, corners, and fastener penetrations are sealed with KERDI-BAND, ensuring a minimum 2" (50 mm) overlap.

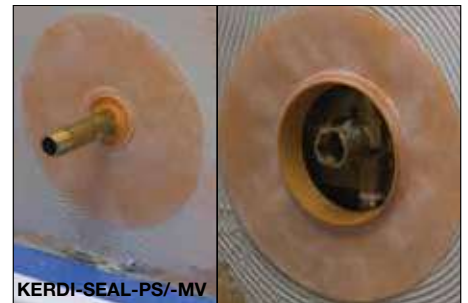

- 6 Any protrusions through the panel (e.g., mixing valve, shower head, etc.) must be sealed with KERDI-SEAL-PS/-MV, KERDI-FIX, or other suitable sealant.



- 7 Seal connections to knee walls using KERDI-KERECK-F preformed corners and Schluter SET™, ALL-SET™, FAST-SET™, or unmodified thin-set mortar.

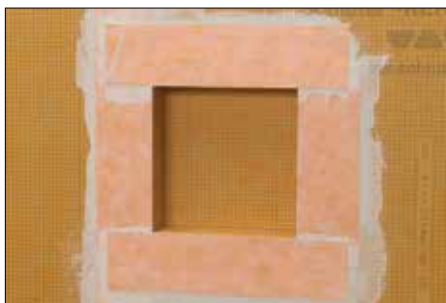

Note: See page 21 for KERDI-BOARD-SN shower niche installation instructions.



- 8 Once all seams, corners, and knee walls have been completely sealed, the assembly is waterproofed and ready to be tiled.

CURBLESS SHOWERS

Accessibility and style

As our population ages, there is increasing demand for accessible living spaces. Tiled showers typically feature curbs to retain water in the stall, which can make entry difficult for those with limited mobility, including individuals who need the assistance of wheelchairs. Curbless tiled showers eliminate the use of a curb and rely on the slope of the floor to keep water inside the stall, thus improving accessibility. These showers have also become increasingly popular for their aesthetic benefits, as they can integrate seamlessly with surrounding tiled surfaces to enhance an already luxurious environment.



DESIGN AND INSTALLATION CONSIDERATIONS

The Schluter®-Shower System provides a simple and effective means of waterproofing curbless installations. The key to this is that the KERDI waterproofing membrane is typically applied. Once the slope to the drain is established, KERDI and tile are installed, thus minimizing the thickness of the assembly.

Curbless tiled showers rely on the slope of the floor to effectively contain water in the immediate shower area and direct water to the drain. Given the wide range of potential configurations, it isn't possible to address them all in this Handbook. However, the following guidelines will assist in planning any curbless installation.

Ideally, the floor will be recessed before installing a sloped mortar bed or the KERDI-SHOWER prefabricated shower trays to allow an even transition at the door threshold. This can be relatively straightforward in new construction and can also be accomplished in renovations. When recessing the floor is not an option, it is necessary to provide a ramp up into the shower area. The KERDI-SHOWER prefabricated trays and ramp can be useful tools in such applications as well. Please note that recessing the floor of a bathroom must be done in a way that preserves the structural integrity and safety of the construction. This may require the services of a qualified design professional (e.g., architect, engineer, etc.).

Waterproofing must be installed in all areas subject to water exposure. Ideally, the entire floor is protected. Install KERDI over mortar beds and Schluter®-Systems prefabricated EPS foam substrates. Use the DITRA or DITRA-HEAT uncoupling membrane over plywood/OSB or concrete subfloors. All seams are sealed using KERDI-BAND. The SHOWERPROFILE-WS/-WSK splash guard profiles may be used at the entrance of curbless showers. Secondary drainage may be required in the drying area for any overflow. Please see detail K-SHBF on page 12 for further discussion.

Note on Accessibility Guidelines:

Various building codes and other sources, such as the Americans with Disabilities Act, include specific requirements for disabled access in public buildings and should be consulted when applicable. Areas of interest may include degree of slope, clearance, and supporting structures such as grab bars.

THE WATERPROOF BATHROOM

Security and utility

Bathrooms are a primary focus of today's building and remodeling projects and are becoming more and more luxurious, complete with steam showers, oversized bathtubs, and the latest in fixtures and lighting. As such, tiled showers, bathtub surrounds, floors, walls, and vanities are in high demand. Tile and stone are beautiful, durable, and available in a wide range of formats, colors, and textures, allowing limitless design options. Tile and stone offer unmatched utility and high-end appeal, making them the ideal surface coverings for bathrooms. Given the substantial investments made in these projects and nature of use, long-term durability is a high priority.



Waterproofing is the foundation of successful tiled bathrooms. Moisture-sensitive construction materials (e.g., wood framing, plywood and OSB sheathing, gypsum wallboard, etc.) are common in the North American building environment and must be protected in wet areas. Wet areas also bring the potential for mold growth if effective moisture management is not provided. The key to mold control is moisture control.

In addition to showers and tub surrounds, bathroom floors surrounding these fixtures are routinely subjected to water exposure during use. Bathroom floors may also, through unexpected circumstances, become exposed to significant amounts of water; for example, an overflowed toilet or ruptured sink supply, which can result in flooding. Waterproofing these floors can save an owner from replacing the tile assembly and substructure in the event of a leak.

Schluter®-Systems offers simple and effective solutions to protect moisture-sensitive substrates, prevent mold growth, and preserve the integrity of the tiled surface throughout the bathroom. The Schluter®-Shower System is an integrated family of products that together form a fully bonded, watertight assembly for tiled showers and bathtub surrounds. DITRA is an uncoupling membrane that protects the tiled floors from damage by neutralizing differential movement stresses between the substrate and tile and provides reliable waterproofing. Since both of these systems are based on topically-applied, bonded waterproof membranes, they can be combined simply and easily to provide waterproofing throughout the bathroom.

Floors can be made fully waterproof with DITRA. Since the membrane is made of waterproof polyethylene, the only extra step necessary is to seal the seams and floor/wall connections with KERDI-BAND. The same practice is used to integrate the DITRA with the KERDI used to waterproof the shower or tub surround. The result is a comprehensive waterproofing system that protects against moisture penetration. For added luxury, the DITRA-HEAT electric floor warming system with integrated uncoupling technology ensures that floors are both comfortable, and resistant to cracked tiles and grout. Cables can be placed wherever heat is desired for customized heating zones, and no leveling compounds are required, making for a quick and easy installation.

Please consult the Schluter®-DITRA and Schluter®-DITRA-HEAT Installation Handbooks for comprehensive installation guidelines and warranty criteria.



Schluter®-DITRA and Schluter®-DITRA-HEAT Installation Handbooks

Complete details and illustrations for tile installations over various substrates, and supplementary information on topics such as waterproofing, movement joints, and thin-set mortars.

To obtain or download a free copy of the DITRA or DITRA-HEAT Installation Handbook, visit www.schluter.com or call **800-472-4588 (US)** or **800-667-8746 (CAN)**.

PROFILES

Details make the difference

Ceramic and stone tiles are durable, easy to maintain, and hygienic, representing the ideal surface coverings for showers and bathtub surrounds. Exposed tile edges, however, are unsightly and prone to cracking and chipping. While ceramic trim pieces such as bullnose or quarter round have traditionally been used to finish and protect tile edges at the outside corners and perimeters of an installation, ceramic trim availability can be limited, particularly in imported tile lines, which can in turn limit overall tile selection.

Ceramic cove base represents a neat, hygienic method for treating transitions at inside corners by providing a curved surface that prevents the collection of dirt and is easy to clean. However, the limited availability of ceramic trim pieces has resulted in the use of sealant and caulk to treat such transitions. These joints must be continually maintained throughout the life of the installation. This may include replacing the joints, which requires cutting the sealant out and possibly compromising the waterproofing membrane.



Finishing and edge protection

Schluter®-Systems offers various finishing and edge-protection profiles for outside corners and other tiled edges that can be used with any field tile, thus reducing dependence on ceramic trim and increasing design options. These profiles are available in a wide range of materials and finishes such as stainless steel, anodized aluminum, brass, and colored PVC to produce a variety of looks, including bold contrasts, discreet color matches to the grout, and complements to plumbing fixtures.

Schluter®-RONDEC

Provides a symmetrically rounded edge for a smooth design.

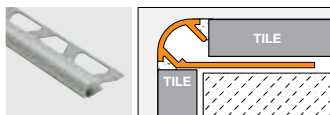

Schluter®-QUADEC

Provides a square edge for a contemporary and sleek design.

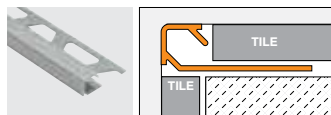

Maintenance-free inside corners

Schluter®-Systems offers various cove-shaped profiles to address the need to finish inside corners. These profiles can be used with any field tile to produce permanent, easy to clean, and maintenance-free floor/wall transitions and inside wall corners.

Schluter®-DILEX-AHK

Allows for easy cleaning and will not trap debris. Anodized and Tuscan color-coated aluminum finishes.

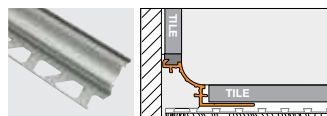

Schluter®-DILEX-PHK

Allows for easy cleaning and will not trap debris. PVC profile.

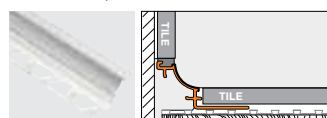

Schluter®-DILEX-HKU

Allows for easy cleaning, will not trap debris. Stainless steel finish.

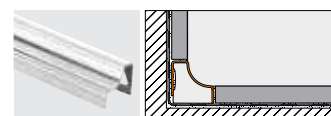

Schluter®-DILEX-EKE

Provides a straight and discreet joint that eliminates sealant at inside corners.

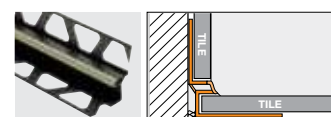

Please refer to our Illustrated Price List or our website at www.schluter.com for details on the complete line of Schluter profiles and accessories available.

TILE SELECTION CONSIDERATIONS

Discussion of different tile types in shower applications

The Schluter®-Shower System is an integrated family of products that creates a sealed system for showers, steam showers, steam rooms, and bathtub surrounds. The Schluter®-KERDI/-KERDI-DS membranes and Schluter®-KERDI-BOARD substrates are waterproof and provide a bonding surface for tile coverings. Typical covering materials include ceramic, porcelain, and natural stone tiles. The following information is intended to be used as input for tile selection in shower applications.

Ceramic and Porcelain

In general, ceramic and porcelain tiles are excellent choices for shower applications. They are not adversely affected by moisture and are easily cleaned. Furthermore, they can be installed using unmodified thin-set mortar within the Schluter®-Shower System. However, some specific categories of these materials require special consideration.

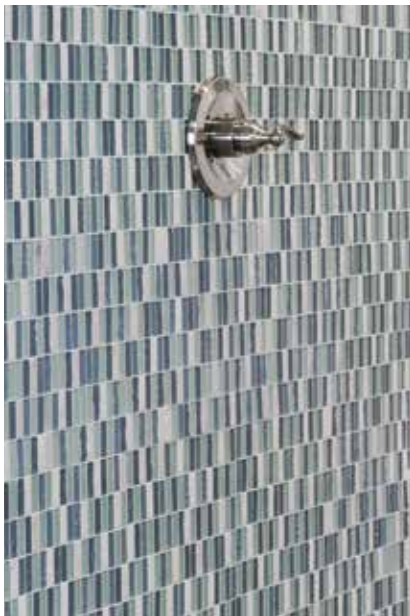

Mounted Mosaic Tiles

Schluter Systems does not specify a minimum tile format for use over the KERDI-SHOWER series of prefabricated foam trays, but when using small tiles with heavy loads a mortar base is recommended.

Mosaic tile are typically mounted and sold as sheets for ease of handling and installation. There are various methods used to mount the tiles, some of which can present installation or application challenges.

Back-mounted and edge-mounted tile assemblies may have paper, mesh, resin, polyurethane, or other bonding material on the back or edges of each tile, which becomes part of the tile assembly. In some cases, the adhesive used to mount the tiles is moisture sensitive and may lead to debonding once the shower is put into service. According to the TCNA Handbook for Ceramic, Glass, and Stone Tile Installation, mounted tile assemblies must feature sufficient exposure of the bonding surface of the tile to allow for 95% contact with the setting material in wet areas. Confirm with the tile manufacturer that the back- or edge-mounted tile is suitable for use in wet areas and never use paper back-mounted mosaics in shower applications.

Face-mounted tiles may use a clear film that is removed after final set or paper that is removed during the installation process before adjustments are made and final set is reached. In general, this approach is superior because the back of the tile is in full contact with the bond coat.



Pebbles

Pebble tiles have been used on shower floors for years, but due to their irregular shape there are some items to address with installation. For example, rounded pebble tiles can create barriers to drainage in showers since the grout is typically not flush with the surface of the pebbles. Maintaining sufficient slope for drainage is essential, perhaps even in excess of the typical 1/4" per foot. Rounded pebble tiles may also require a relatively thick bond coat to ensure proper coverage and bond to the shower base. Pebble tiles with flat surfaces can be easier to install with respect to the issues described above. Grout joints in pebble tile applications are typically wider than those in square or rectangular tile applications. Follow the tile and setting material manufacturer's instructions for grout selection.

Large Porcelain Tile Panels

Large porcelain tile panels are growing in availability and interest in North America. Some of these tile panels feature resin or urethane backings, which require special setting materials, such as modified thin-set mortars or epoxy adhesives. Panel manufacturers may require modified thin-set mortars to install panels without backings as well. Often, these manufacturers have tested and recommend specific mortars to install the panels, not just any mortar within a category or meeting an ANSI specification. Contact the panel manufacturer and setting material manufacturer to obtain a recommendation for a specific setting material to install the panel over a bonded waterproofing system.



Natural Stone

Natural stone tiles are a product of nature and have various characteristics that provide beauty and features not found in manufactured tile products. According to the Dimension Stone Design Manual published by the Marble Institute of America (MIA), selection of stone for a shower is critical since the impact of water on certain stones (e.g. polished marble, limestone, etc.) may cause deterioration (e.g., surface dulling, warpage, etc.) over time. Selection of a dense, moisture-resistant stone will provide the best results in a shower.

Moisture-Sensitive Stone

According to the TCNA Handbook for Ceramic, Glass, and Stone Tile Installation, many green-colored marbles and serpentines warp when exposed to water, including the water mixed in cement-based setting materials. Such stones may not be suitable for use in shower applications and/or may require special setting materials. Schluter Systems recommends consulting with the stone supplier to help determine if a particular material is suitable for use in wet areas and that a 100% solids epoxy tile adhesive is used to install the stone.

Fiberglass Mesh Reinforced Stone

According to the TCNA Handbook for Ceramic, Glass, and Stone Tile Installation, many stone products have mesh reinforcement attached to the back surface of the tile, typically using an epoxy or polyester-based adhesive. Cement-based setting materials will not bond to these backings and Schluter Systems recommends using a 100% solids epoxy tile adhesive to install the stone.

Mounted Mosaic Stone Tiles

Similar challenges as ceramic and porcelain mounted mosaic tiles. See mounted mosaic tiles section under ceramic and porcelain tile.



Glass

Glass tile is available in a wide variety of types (e.g., cast, fused, sintered, etc.) and formats. Entire tiles may be imbued with color, while in other cases layers of clear glass are combined with different backings of different color that show through. Some backings are dusted with quartz (sand) to provide texture to improve bonding characteristics. However, other backings are smooth and glossy, making it difficult to achieve a bond.

Furthermore, some glass tile manufacturers do not recommend use of their clear glass tile directly over bonded waterproofing membranes. They want the substrate to be able to wick water away from the bond coat (e.g., CBU or mortar walls) to help maintain a uniform bond coat appearance. Confirm with the glass tile manufacturer that the glass tile is suitable for use in wet areas and can be installed directly over a bonded waterproofing membrane such as KERDI.

Check with the glass tile manufacturer and setting materials manufacturer for setting materials recommendations.

Mounted Mosaic Glass Tiles

Similar challenges as ceramic and porcelain mounted mosaic tiles. See mounted mosaic tiles section under ceramic and porcelain tile.

THIN-SET FACTS

Discussion on thin-set mortars and Schluter®-KERDI installations



Schluter®-Systems offers thin-set mortars designed for use with Schluter® membranes and boards. All Schluter®-Systems' thin-set mortars, including the ALL-SET™ and FAST-SET™ modified varieties, can be used to set tile over Schluter®-DITRA, DITRA-HEAT, KERDI, KERDI-BOARD, etc. non absorptive substrates. If Schluter® thin-set mortars are not used, we require unmodified thin-set mortar when setting ceramic or porcelain tile over KERDI.

QUESTION: Should a latex-modified thin-set mortar or an unmodified thin-set mortar be used to install Schluter®-KERDI?

ANSWER:

The type of bonding mortar used to apply KERDI must be suitable for the substrate and mechanically anchor the fleece on the KERDI. For all the substrates listed in this Handbook (e.g., gypsum board, cement backerboard, etc.), Schluter SET™, ALL-SET™, FAST-SET™ or an unmodified thin-set mortar is recommended. When installing KERDI with unmodified thin-set mortar over particularly dry and porous substrates, it is recommended to wet the substrate first, in order to help prevent premature drying or skinning of the thin-set mortar. Schluter SET™, ALL-SET™, FAST-SET™ or an unmodified thin-set mortar must be used to construct all KERDI seams to ensure watertight performance of the system. Learn more below.

QUESTION: Can ceramic tile, including porcelain tile, be set on Schluter®-KERDI with unmodified thin-set mortar?

ANSWER: YES. In general, we recommend it. Here's why:

Portland cement-based unmodified thin-set mortars are dependent on the presence of moisture for hydration in order to gain strength. Since KERDI is impervious, it does not deprive the mortar of its moisture. This allows the cement to properly hydrate, resulting in a strong, dense bond coat. In fact, after the mortar has reached final set (usually within 24 hours), unmodified thin-set mortars achieve higher strengths when cured in continually moist conditions.

QUESTION: Can ceramic tile, including porcelain tile, be set on Schluter®-KERDI with latex-modified thin-set mortar?

ANSWER: In general, We DON'T recommend it. Here's why:

Latex-modified mortars must dry for the polymers to coalesce and form a hard film in order to gain strength. When sandwiched between two impervious materials such as KERDI and ceramic tile, including porcelain tile, drying takes place very slowly through the open joints in the tile covering. [According to the Tile Council of North America's Handbook for Ceramic, Glass, and Stone Tile Installation, this drying period can fluctuate from 14 days to over 60 days, depending on the geographic location, the climatic conditions, and whether the installation is interior or exterior]. Therefore, extended cure times could be required before grouting if using modified thin-set mortars between KERDI and ceramic tile, including porcelain tile. If extended cure times were not observed, the results could be unpredictable. This is even more important to consider in wet areas such as showers, as there is the additional concern of latex leaching.

QUESTION: How do I know if the thin-set mortar is modified or unmodified?

ANSWER:

In general, unmodified thin-set mortar is a blend of Portland cement, sand, and water retention agents that is mixed with water by the user. The applicable product standard for unmodified thin-set mortars is ANSI A118.1. Look for this standard on the packaging (e.g., product meets ANSI A118.1 when mixed with water). Unmodified thin-set mortar may also be referred to as dry-set mortar by the manufacturer. Modified thin-set mortars are similar to unmodified thin-set mortars, but include additional polymers such as latex. The additional polymers are introduced in either liquid or powder form. In the first case, the user mixes an unmodified or dry-set mortar powder with a liquid polymer additive instead of water. In the second case, the polymers are added by the manufacturer to the dry blend in powder form. The user then mixes the powder with water. The applicable product standards for modified thin-set mortars include ANSI A118.4 and ANSI A118.11.

QUESTION: Can Schluter ALL-SET™ and FAST-SET™ modified thin-set mortars be used to set tile over Schluter boards and membranes?

ANSWER: Yes.

All Schluter® thin-set mortars, including the ALL-SET™ and FAST-SET™ modified varieties can be used to set tile over DITRA, DITRA-HEAT, KERDI, KERDI-BOARD, etc. non absorptive substrates.

QUESTION: How is this possible?

ANSWER: The key is predictability.

Schluter Systems' modified thin-set mortars have been specifically formulated to set and gain strength in a timeframe that fits typical installation practice, even when sandwiched between Schluter® membranes or boards and porcelain tile. The proportions of cement, water-retention agents, polymers, and other components in the mixtures were balanced to ensure that extended dry times are not required. This was validated through both laboratory and practical testing. Now, the installer can select from either unmodified or modified thin-set mortar to install tiles within our systems according to his or her preference.

QUESTION: Why did Schluter Systems change its position on thin-set mortar?

ANSWER:

We haven't changed our position on thin-set mortar use within our systems. Developing our own setting materials has given us the ability to guarantee consistently positive results. And since we control the formulas, we can be sure no changes will be made that have a negative impact on setting times and strength gain in these environments.

QUESTION: Does this mean I can use other manufacturers' modified thin-set mortars to install tile over Schluter boards and membranes?

ANSWER: No.

Our position on thin-set mortar use within our systems in general has not changed. We have no control over the formulation of other manufacturers' products and therefore cannot guarantee consistently positive results with their modified thin-set mortars.

QUESTION: Can I still use other manufacturers' unmodified thin-set mortars to install tile over Schluter boards and membranes?

ANSWER: Yes.

We still warrant the use of unmodified thin-set mortar meeting ANSI A118.1 to install tile within our systems because we have confidence in the performance of this product category. This is based on the science of cement hydration and years of positive testing and field experience.

Please note, if Schluter® thin-set mortars are used with Schluter® membranes an extended system warranty is available. For full warranty details, please visit schluter.com/warranty.

ADDITIONAL NOTES

- Remember, all thin-set mortars have an acceptable temperature range that must be observed during application and curing.
- Pre-mixed thin-set mortars and mastics are not suitable for use in conjunction with the Schluter®-Shower System.

TESTING, LISTINGS, & APPROVALS

Products and system evaluation

Schluter®-Systems is committed to providing reliable installation systems for tile and stone. As part of this commitment, we have invested considerable resources in testing our products and obtaining listings and approvals through various certification organizations to provide our customers and local code officials with relevant data that supports the efficacy of our system.

TEST DATA

KERDI, KERDI-DS, DITRA, DITRA-XL, DITRA-HEAT, and DITRA-HEAT-DUO have been independently tested and found to meet or exceed the requirements of the American National Standard Specifications for Load Bearing, Bonded, Waterproof Membranes for Thin-set Ceramic Tile and Dimension Stone Installation A118.10. Data for KERDI and KERDI-DS are presented in the table below.

Property	Requirement	Performance	
		KERDI	KERDI-DS
Fungus and micro-organism resistance	The membrane shall not support mold growth	Pass	Pass
Seam strength	16 lb/2 in width	36 lb/2 in width	37 lb/2 in width
Breaking strength	170 psi	1084 psi	1275 psi
Dimensional stability	0.7% maximum length change	Pass	Pass
Waterproofness	No moisture penetration	Pass	Pass
7-day shear strength	50 psi	87 psi	87 psi
7-day water immersion shear strength	50 psi	77 psi	99 psi
4-week shear strength	50 psi	96 psi	93 psi
12-week shear strength	50 psi	90 psi	87 psi
100-day water immersion shear strength	50 psi	120 psi	116 psi

KERDI, KERDI-DS, and KERDI-BOARD have also been independently tested to determine the water vapor permeance of the products. Please see further discussion on the importance of water vapor permeance on page 43.

Product	Test method	Performance
KERDI	ASTM E96*	0.90 perms
KERDI-DS		0.19 perms
KERDI-BOARD 1/2" (12.5 mm)		0.36 perms

* Using the desiccant method at 100°F (38°C) and 90% RH

KERDI and KERDI-DS have been evaluated according to the "Standard Method for the Testing and Evaluation of Volatile Organic Chemical Emissions from Indoor Sources Using Environmental Chambers, Version 1.1" for California Specification 01350 and found to comply with the VOC requirements. California Specification 01350 is referenced by various green building standards and rating systems.

PRODUCT EVALUATIONS AND LISTINGS

Schluter®-Shower System (Membranes and Drains)

- ICC-ES PMG Report No. PMG-1204

Membranes (KERDI/DITRA/DITRA-XL/DITRA-HEAT/DITRA-HEAT-DUO)

- ICC-ES Report No. ESR-2467
- cUPC® listed to meet ANSI A118.10
- Los Angeles Research Report

DITRA-HEAT and DITRA-HEAT-DUO membranes are not included in the Los Angeles Research Report.

Drains (KERDI-DRAIN and KERDI-LINE)*

- UPC® listed to meet IAPMO IGC 195
- Certified by CSA to meet CSA B79
- Certified by NSF as special engineered product to meet applicable requirements of ASME A112.6.3
- Los Angeles Research Report

*KERDI-DRAIN and KERDI-LINE are available in various configurations. Please refer to pages 47 to 49 for information regarding which configurations are listed and certified.

APPROVALS

Schluter®-Shower System

- Massachusetts
- Michigan
- Kentucky
- Wisconsin

Copies of the aforementioned test reports, listings, and approvals are available upon request. Listings and approvals may also be accessed via our website at www.schluter.com.

MOLD

The importance of mold control

The term “mold” is used to describe visible fungal growth. Mildew is another common term which refers to the type of fungi found growing on window sills and in bathrooms. Fungi are everywhere in our environment and are found both indoors and outdoors. However, the type and amount found in the home can be an important health issue. Understanding how to effectively control mold growth is very important.

What is Mold?

Fungi are different from plants and animals. Fungi cannot produce their own nutrients as plants do and reproduce differently than both plants and animals. Molds reproduce by making spores which travel through the air to deposit on surfaces. If the conditions are right for reproduction they can grow and continue to multiply. The filamentous parts of mold attach to nutrients and form networks called mycelia. It is these networks that are visible to us in the indoor environment. Molds come in a variety of colors, but we commonly see them as green or black.

Over 1000 different species of mold have been identified in homes, but they are not all toxic to humans. Molds growing inside a home may release chemicals and spores and some may even produce mycotoxins. The chemicals released by fungi are called volatile organic compounds (VOC). For example, ethanol is a common VOC that is responsible for the distinctive musty or earthy odor associated with mold.

Health Effects

Mold can cause damage to building materials and may have adverse health effects on some individuals. The susceptibility of people to develop symptoms depends on the nature of the fungal material, genetic predisposition, age, state of health, and extent of exposure. Although there is insufficient evidence in the scientific community to determine with certainty the association between mold exposure and the effect on human health, it is of course recommended to control mold exposure in the home and workplace. Common health effects associated with exposure to mold are a variety of upper and lower respiratory tract symptoms: cough; nose, throat and eye irritation; rhinitis; sneezing; and wheezing. These symptoms are similar to allergies and associated with asthma. Mycotoxins are fungal metabolites that have a toxic effect on humans. Toxic effects are associated with symptoms such as fever, nausea, headaches, and skin irritations.

Factors for Mold Growth

Fungi need a source of moisture, organic material to serve as a source of nutrients, and a warm environment with a temperature range from 50 to 107 °F (10 to 42 °C) to grow. For most species of fungi, a neutral to acidic pH is preferred, with a high pH level indicating an alkaline environment that is generally not conducive to mold growth. Mold will reproduce in such conditions as long as moisture is present. Once the area is dry, the mold may stop reproducing but can continue to be allergenic to susceptible people. If moisture is reintroduced, the mold will again start the reproduction cycle and grow.

Controlling Mold Growth

As stated above, four conditions must be satisfied to support mold growth.

1. Mold spores
2. Food source (organic material)
3. Warm temperatures: 50 to 107 °F (10 to 42 °C)
4. Moisture

Mold spores travel through the air indoors and outdoors and are impossible to eliminate. The use of organic materials in construction is common in today's building environment. Examples include wood framing members (e.g., studs, joists, I-joists, and trusses), plywood or OSB subfloors, paper-faced gypsum boards on walls and ceilings, etc. Room temperature falls within the temperature range suitable for mold growth. Therefore, the control of moisture, including liquid water and water vapor, is the only viable method for controlling mold growth in the indoor environment.

Showers are critical areas with respect to mold and moisture control. They are commonly exposed to thousands of gallons of water per year and high humidity levels. The tile covering alone will not prevent water and moisture penetration. As such, it is essential that an effective moisture management system be designed and installed properly to protect surrounding building materials and prevent mold growth.

The traditional method for installing tiled shower assemblies creates a water in/ water out system. Since shower pan liners are placed below the mortar setting bed in these assemblies, moisture is allowed to saturate the mortar bed before exiting the system through the weep holes in the drain. When the pan liner is placed on a level substrate instead of a sloped surface, a relatively common error, moisture in the system will have no means to exit through the weep holes in the drain and the mortar bed will remain saturated for extended periods of time. The continued presence of moisture, combined with organic materials carried into the mortar bed by the rinse water, warm temperatures, and reduced pH as soluble salts are washed out of the mortar bed, increases the risk of mold growth within the system.

The Schluter®-Shower System is an integrated family of products that creates a sealed system. KERDI is a bonded waterproof membrane that is installed on top of the mortar bed and solid backing on walls. Tile is installed directly over the membrane using thin-set mortar. The KERDI-DRAIN was designed specifically to ensure a simple and secure connection to bonded waterproof membranes, such as KERDI, at the top of the assembly rather than below it. The resulting assembly does not permit moisture penetration into the solid backing or mortar bed, thus limiting the amount of water behind the tile covering and allowing the shower to dry out between uses. Furthermore, KERDI is a vapor retarder that protects wall cavities from water vapor penetration. Thus, the Schluter®-Shower System provides superior moisture management and reduces the potential for mold growth within the system.

Regardless of the system used to waterproof a tiled shower, it is important to provide adequate ventilation (e.g., exhaust fans) in the bathroom to effectively manage water vapor and reduce condensation on all bathroom surfaces.

Further discussion and recommendations for mold remediation can be found in various sources, including the following.

- “A Brief Guide to Mold, Moisture, and Your Home” – U.S. Environmental Protection Agency (EPA)
- “Mold Remediation in Schools and Commercial Buildings” – U.S. Environmental Protection Agency (EPA)
- “Mould Guidelines for the Canadian Construction Industry” – Canadian Construction Association

VAPOR

The importance of water vapor management



Why is water vapor management important?

It is important to consider that water exists as both liquid and vapor in showers, and must be managed in both forms. The prime example of this is the steam shower. Steam showers that are not designed to manage water vapor have caused mold growth in wall cavities, rot in wood framing, and damage to moisture-sensitive wall coverings on the opposite side of the stud cavities.

Do all waterproofing membranes manage water vapor?

The ANSI A118.10 standard for bonded waterproof membranes was developed to provide a framework for determining the suitability of these products to serve as barriers to liquid water only. As such, the standard does not include a minimum criterion to establish the ability of products to limit vapor transmission. Thus, simply selecting a membrane that meets the requirements of the ANSI A118.10 standard for a steam shower application is not enough. The ability of the product to limit vapor transmission must be considered as well.

How can I identify a waterproofing membrane that manages water vapor?

Water vapor permeance is a measure of how quickly water vapor is transmitted through a material and can be determined according to the ASTM E96 Standard Test Method for Water Vapor Transmission of Materials. The higher the vapor permeance, the less effective a material is at slowing vapor transmission.

There is no universal requirement for vapor permeance of membranes in the building industry. The environmental conditions (i.e., differences in temperature and relative humidity), building materials, etc., and relevant field experience will determine the appropriate membrane performance for a given application. The consensus within the tile industry in North America has been that a vapor permeance of 1.0 perm or less will manage vapor effectively in showers and intermittent use steam shower applications.

The TCNA Handbook for Ceramic, Glass, and Stone Tile Installation and the TTMAC Specification Guide 09 30 00 Tile Installation Manual specify a water vapor permeance of 0.5 perms or less for bonded waterproofing membranes used in continuous use steam rooms (e.g., those found in health clubs, spas, etc.) when tested using the desiccant method at 100°F (38°C) and 90% RH.

Does the Schluter®-Shower System manage water vapor?

Schluter®-Systems has tested the various options within the Schluter®-Shower System for moisture management, including KERDI, KERDI-DS, and KERDI-BOARD in the more aggressive conditions referenced above. The table below summarizes Schluter®-Systems' recommendations for the use of these products and respective water vapor permeance values.

Product	Recommended Applications	Water Vapor Permeance (perms) ¹
KERDI	Showers, intermittent use steam showers, and bathtub surrounds	0.90
KERDI-DS	Continuous use steam rooms	0.19
KERDI-BOARD	Showers, intermittent use steam showers, and bathtub surrounds	0.36 ²

¹Tested according to ASTM E96, using the desiccant method at 100°F (38°C) and 90% RH

²1/2" – 12.5 mm-thick KERDI-BOARD tested

While the water vapor permeance of KERDI-BOARD meets the water vapor permeance recommendations for continuous use steam rooms in tile industry standard guidelines, Schluter®-Systems has chosen to require the KERDI-DS membrane for these demanding applications in an effort to be conservative and provide the best possible solution for our customers.

Thus, the Schluter®-Shower System has solutions that provide superior moisture management for virtually any tile application.

PRODUCT & ORDERING INFO

Ordering information for the **Schluter®-Shower System** and **DITRA** components outlined in this Handbook is located below. For technical support, our Illustrated Price List, or additional information on our complete product line, please call **800-472-4588 (USA)** or **800-667-8746 (Canada)**, or visit our comprehensive website at **www.schluter.com**.

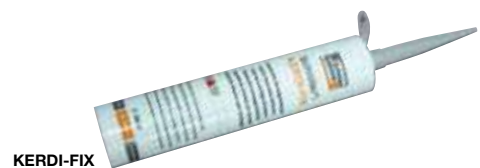
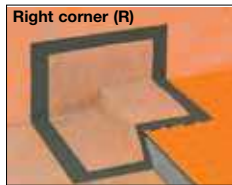
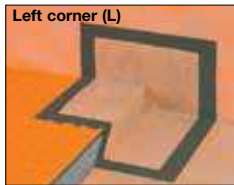
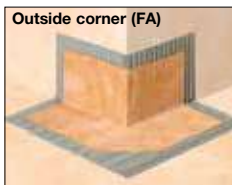
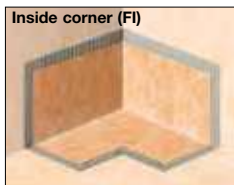
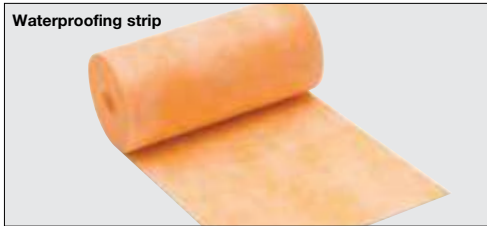

*Color codes: **BW** - Bright white, **G** - Grey

Note: 1 mil = 1 one-thousandth of an inch.

KERDI is listed by cUPC® and evaluated by ICC-ES (Report Nos. ESR-2467 and PMG-1204).

Schluter®-KERDI

KERDI is a pliable sheet-applied polyethylene waterproofing membrane and vapor retarder that guarantees uniform thickness. It is covered on both sides with a fleece webbing to anchor the membrane in thin-set mortar.

KERDI waterproofing membrane		
Item No.	Dimensions	Thickness
KERDI 200/5M	3' 3" x 16' 5" = 54 ft ² (1 m x 5 m = 5 m ²)	8 mil
KERDI 200/7M	3' 3" x 23' = 75 ft ² (1 m x 7 m = 7 m ²)	8 mil
KERDI 200/10M	3' 3" x 33' = 108 ft ² (1 m x 10 m = 10 m ²)	8 mil
KERDI 200/20M	3' 3" x 65' 7" = 215 ft ² (1 m x 20 m = 20 m ²)	8 mil
KERDI 200	3' 3" x 98' 5" = 323 ft ² (1 m x 30 m = 30 m ²)	8 mil
KERDI-DS waterproofing membrane		
KERDI-DS	3' 3" x 98' 5" = 323 ft ² (1 m x 30 m = 30 m ²)	20 mil
KERDI-BAND waterproofing strip		
KEBA 100/125/5M	5" x 16' 5" (125 mm x 5 m)	4 mil
KEBA 100/125/10M	5" x 33' (125 mm x 10 m)	4 mil
KEBA 100/185/5M	7-1/4" x 16' 5" (185 mm x 5 m)	4 mil
KEBA 100/250/5M	10" x 16' 5" (250 mm x 5 m)	4 mil
KEBA 100/125	5" x 98' 5" (125 mm x 30 m)	4 mil
KEBA 100/185	7-1/4" x 98' 5" (185 mm x 30 m)	4 mil
KEBA 100/250	10" x 98' 5" (250 mm x 30 m)	4 mil
KERDI-KERECK-F waterproofing corners		
Item No.	Type/Quantity	Thickness
KERECK/FI 2	Inside corner / 2 units	4 mil
KERECK/FI 10	Inside corner / 10 units	4 mil
KERECK/FA 2	Outside corner / 2 units	4 mil
KERECK/FA 10	Outside corners / 10 units	4 mil
KERDI-KERECK-F 135° inside and bench corners		
Item No.	Packaging	Thickness
KERSB135K	Bench/neo-angle package 1 left and 1 right bench corner, 2 135° inside corners	
KERECK135FI2	135° inside corners / 2 units	4 mil
KERECK135FI10	135° inside corners / 10 units	4 mil
KERSB135KLR	1 left and 1 right bench corner	4 mil
KERSB135K5LR	5 left and 5 right bench corner	4 mil
KERDI-KERS waterproofing corners		
Item No.	Type/Size	Thickness
KERS20L	Left: 3/4" (20 mm)	4 mil
KERS28L	Left: 1-1/8" (28 mm)	4 mil
KERS20R	Right: 3/4" (20 mm)	4 mil
KERS28R	Right: 1-1/8" (28 mm)	4 mil
KERDI-SEAL-PS pipe seal with gasket		
Item No.	Opening diameter/Quantity	Thickness
KMS185/12	1/2" (12.5 mm) / 1 unit	4 mil
KMS185/20	3/4" (20 mm) / 1 unit	4 mil
KMS10185/12	1/2" (12.5 mm) / 10 units	4 mil
KMS10185/20	3/4" (20 mm) / 10 units	4 mil
KERDI-KM pipe seal		
KM5117/22	7/8" (22 mm) / 5 units	4 mil
KERDI-SEAL-MV mixing valve seal with gasket		
KMSMV235/114	4-1/2" (114 mm) / 1 unit	4 mil
KMSMV10235/114	4-1/2" (114 mm) / 10 units	4 mil
KERDI-FIX adhesive/sealant		
Item No.	Volume	
KERDIFIX 100G	100 ml	
KERDIFIX/color*	290 ml	











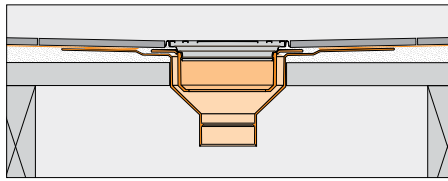



Schluter®-KERDI-DRAIN

KERDI-DRAIN is a floor drain designed with a sloped, integrated bonding flange to provide a secure connection to KERDI and other bonded waterproof membranes at the top of the assembly.







Unique Features and Benefits:

- Appropriate for both mortar bed and KERDI-SHOWER-ST tray installations.
- Features a fully adjustable grate (available in stainless steel and aluminum in various finishes) that accommodates a wide range of tile thicknesses: 1/4" to 1-1/4" (6 mm to 32 mm); or a tileable covering support that accommodates any tile thickness and creates a virtually invisible drainage line.
- Ideal for new construction and renovation work.
- Saves installation time and labor, as it eliminates the prep work required for a traditional two-step mortar pan.
- Integrated bonding flange ensures secure connection to KERDI at top of the assembly.



4" Grate Options			6" Grate Options	
Tileable Covering Support	Anodized Aluminum	Stainless Steel	Stainless Steel	
 <p>Tileable (ECS) Patent pending</p>	 <p>Brushed nickel (ATGB)</p>  <p>Brushed copper (AKGB)</p>  <p>Brushed brass (AMGB)</p>	 <p>Stainless steel (E)</p>  <p>Chrome (EP)</p>  <p>Oil-rubbed bronze (EOB)</p>	 <p>(6E)</p>  <p>(6RE)</p>	
		 <p>Pure</p>  <p>Curve</p>  <p>Floral</p>		

KERDI-DRAIN - Components - ABS, PVC or stainless steel flange

ABS or PVC flange	Stainless steel flange	Includes	Description	Quantity
		1 KERDI-DRAIN	Drain with integrated bonding flange in ABS, PVC or stainless steel, and grate assembly	1
		2 KERDI-KERECK-F	Pre-formed waterproofing corners	4 inside 2 outside
		3 KERDI-SEAL-PS	Pipe seal (3/4" - 20 mm)	1
		4 KERDI-SEAL-MV	Mixing valve seal	1
		5 KERDI-FIX	Sealing and bonding compound (100 ml) (Included with stainless steel flange only)	1

2" (50 mm) drain outlet

	ABS flange	PVC flange	Stainless steel flange
4" (100 mm) Square Grate			
Stainless steel (E)	KD2/ABS/E ¹	KD2/PVC/E ¹	KD2/E/E ¹
Chrome (EP)	KD2/ABS/EP ¹	KD2/PVC/EP ¹	KD2/E/EP ¹
Oil-rubbed bronze stainless steel (EOB)	KD2/ABS/EOB	KD2/PVC/EOB	KD2/E/EOB
Brushed brass anod. alu. (AMGB)	KD2/ABS/AMGB ¹	KD2/PVC/AMGB ¹	KD2/E/AMGB ¹
Brushed copper/ bronze anod. alu. (AKGB)	KD2/ABS/AKGB ¹	KD2/PVC/AKGB ¹	KD2/E/AKGB ¹
Brushed nickel anod. alu. (ATGB)	KD2/ABS/ATGB ¹	KD2/PVC/ATGB ¹	KD2/E/ATGB ¹
Tileable (ECS)	KD2/ABS/ECS ¹	KD2/PVC/ECS ¹	KD2/E/ECS ¹
6" (150 mm) Square or Round Grate			
Square Grate stainless steel (E)	KD2/ABS/6E ¹	KD2/PVC/6E ¹	KD2/E/6E ¹
Round Grate stainless steel (E)	KD2/ABS/6RE ¹	KD2/PVC/6RE ¹	KD2/E/6RE ¹

3" (75 mm) drain outlet

	ABS flange	PVC flange	Stainless steel flange
6" (150 mm) Square or Round Grate			
Square Grate stainless steel (E)	KD3/ABS/6E ¹	KD3/PVC/6E ¹	KD3/E/6E ¹
Round Grate stainless steel (E)	KD3/ABS/6RE ¹	KD3/PVC/6RE ¹	KD3/E/6RE ¹

2" (50 mm) drain outlet

	Item No.
4" (100 mm) Square Grate	
Curve	KDGIF10EBD6/GR
Floral	KDGIF10EBD5/GR
Pure	KDGIF10EBD8/GR

Also available:

Stainless steel flange with 2" (50 mm) threaded outlet.
Listed by ICC-ES (Report No. PMG-1204), UPC®, CSA, and NSF.

¹ Listed by ICC-ES (Report No. PMG-1204), UPC®, CSA, and NSF.



Residential



Commercial

Schluter®-KERDI-DRAIN - Adaptor Kits

KERDI-DRAIN ADAPTOR KITS are used to convert traditional clamping ring drains to integrated bonding flange drains when removal of the clamping ring drain is not practical.

Schluter®-KERDI-DRAIN with residential adaptor ring and ABS flange

	Includes	Description	Quantity	
	1	KERDI-DRAIN	Drain, with integrated bonding flange and grate assembly	1
	2	Adaptor ring**	For residential clamping ring drains	1
	3	KERDI-KERECK-F	Preformed waterproofing corners	4 inside and 2 outside
	4	KERDI-SEAL-PS	Pipe seal (3/4" - 20 mm)	1
	5	KERDI-SEAL-MV	Mixing valve seal	1
	6	KERDI-FIX	Sealing and bonding compound (100 ml)	1

** © Schluter®-Systems L.P., U.S. patent No. D593,641, other patents pending.

Schluter®-KERDI-DRAIN with commercial adaptor ring and ABS flange

	Includes	Description	Quantity	
	1	KERDI-DRAIN	Drain, with integrated bonding flange in ABS or stainless steel, and grate assembly	1
	2	Adaptor ring**	For commercial clamping ring drains	
3	KERDI-FIX	Sealing and bonding compound (100 ml)		

** © Schluter®-Systems L.P., U.S. patent No. D593,641, other patents pending.

Residential	
	Adaptor kit with standard ABS bonding flange
4" (100 mm) Square Grate	
Stainless steel (E)	KDAR/ABS/E
Chrome (EP)	KDAR/ABS/EP
Oil-rubbed bronze stainless steel (EOB)	KDAR/ABS/EOB
Brushed brass anod. alu. (AMGB)	KDAR/ABS/AMGB
Brushed copper/ bronze anod. alu. (AKGB)	KDAR/ABS/AKGB
Brushed nickel anod. alu. (ATGB)	KDAR/ABS/ATGB

Commercial			
	Standard ABS bonding flange	Extended ABS bonding flange	Stainless steel bonding flange
4" (100 mm) Square Grate			
Stainless steel (E)	KDA/ABS/E	KDA/ABSL/E	KDA/E/E
Chrome (EP)	KDA/ABS/EP	KDA/ABSL/EP	KDA/E/EP
Oil-rubbed bronze stainless steel (EOB)	KDA/ABS/EOB	KDA/ABSL/EOB	KDA/E/EOB
Brushed brass anod. alu. (AMGB)	KDA/ABS/AMGB	KDA/ABSL/AMGB	KDA/E/AMGB
Brushed copper/ bronze anod. alu. (AKGB)	KDA/ABS/AKGB	KDA/ABSL/AKGB	KDA/E/AKGB
Brushed nickel anod. alu. (ATGB)	KDA/ABS/ATGB	KDA/ABSL/ATGB	KDA/E/ATGB
Tileable grate (ECS)	KDA/ABS/ECS	KDA/ABSL/ECS	KDA/E/ECS
6" (150 mm) Square or Round Grate			
Square Grate stainless steel (E)	KDA/ABS/6E	KDA/ABSL/6E	KDA/E/6E
Round Grate stainless steel (E)	KDA/ABS/6RE	KDA/ABSL/6RE	KDA/E/6RE

Schluter®-KERDI-LINE



KERDI-LINE is a low profile linear floor drain specifically designed for bonded waterproofing assemblies. KERDI-LINE can be installed adjacent to walls or at intermediate locations in showers, wet rooms, and other applications that require waterproofing and drainage. The floor can be sloped on a single plane to KERDI-LINE, which enables the use of large-format tiles and creates interesting design opportunities.

The KERDI-LINE channel body is made of formed stainless steel and features a collar made of Schluter-KERDI for a secure waterproof connection. The grate assembly is available in three design options. Grate and frame assemblies (A and B) are available in brushed stainless steel, or stainless steel with chrome finish, and can be adjusted for use with tile coverings from 1/8" to 1" (3 mm to 25 mm)-thick. The tileable covering can accommodate any thickness of tile covering.

Note: There are multiple selections to be made for this product. Start by selecting the appropriate flange length then proceed to grate selection accordingly, keeping in mind there are two frame height options and three grate options.

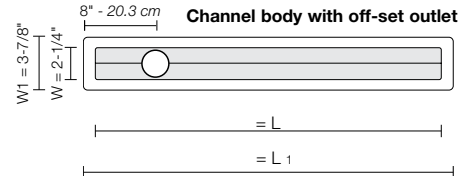
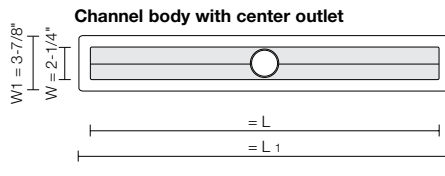
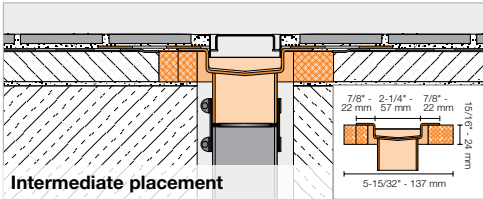
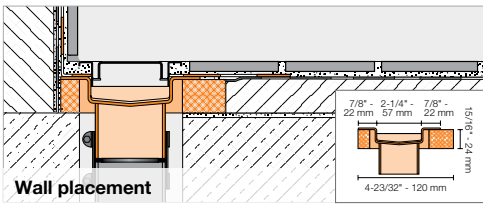

Closed (A) – Brushed stainless steel



Closed (A) – Chrome

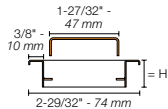

Perforated (B) – Brushed stainless steel



Perforated (B) – Chrome

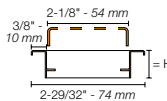

Curve



Floral

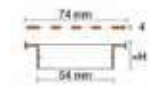

Frameless Tileable (D)



Pure



KERDI-LINE linear floor drain			
Channel body - stainless steel			
L = in. - cm	L ₁ = in. - cm	Center outlet	Off-set outlet
19-11/16 - 50	21-11/16 - 55	KLV 60 E 50	-
23-5/8 - 60	25-5/8 - 65	KLV 60 E 60	-
27-9/16 - 70	29-9/16 - 75	KLV 60 E 70	KLVO 60 E 70
31-1/2 - 80	33-1/2 - 85	KLV 60 E 80	KLVO 60 E 80
35-7/16 - 90	37-7/16 - 95	KLV 60 E 90	KLVO 60 E 90
39-3/8 - 100	41-3/8 - 105	KLV 60 E 100	KLVO 60 E 100
43-5/16 - 110	45-5/16 - 115	KLV 60 E 110	KLVO 60 E 110
47-1/4 - 120	49-1/4 - 125	KLV 60 E 120	KLVO 60 E 120
51-3/16 - 130	53-3/16 - 135	KLV 60 E 130	-
55-1/8 - 140	57-1/8 - 145	KLV 60 E 140	-
59-1/16 - 150	61-1/16 - 155	KLV 60 E 150	-
62-15/16 - 160	64-15/16 - 165	KLV 60 E 160	-
66-7/8 - 170	68-7/8 - 175	KLV 60 E 170	-
70-13/16 - 180	72-13/16 - 185	KLV 60 E 180	-

KERDI-LINE linear floor drain			
Length = in. - cm	Curve	Floral	Pure
	Frame = 29/32" - 23 mm	Frame = 29/32" - 23 mm	Frame = 29/32" - 23 mm
19-11/16 - 50	KLIFF 23 EB 50	KLIFE 23 EB 50	KLIFG 23 EB 50
23-5/8 - 60	KLIFF 23 EB 60	KLIFE 23 EB 60	KLIFG 23 EB 60
27-9/16 - 70	KLIFF 23 EB 70	KLIFE 23 EB 70	KLIFG 23 EB 70
31-1/2 - 80	KLIFF 23 EB 80	KLIFE 23 EB 80	KLIFG 23 EB 80
35-7/16 - 90	KLIFF 23 EB 90	KLIFE 23 EB 90	KLIFG 23 EB 90
39-3/8 - 100	KLIFF 23 EB 100	KLIFE 23 EB 100	KLIFG 23 EB 100
43-5/16 - 110	KLIFF 23 EB 110	KLIFE 23 EB 110	KLIFG 23 EB 110
47-1/4 - 120	KLIFF 23 EB 120	KLIFE 23 EB 120	KLIFG 23 EB 120

KERDI-LINE linear floor drain								
L = in. - cm	Grate A - Brushed stainless steel		Grate A - Chrome	Grate B - Brushed stainless steel		Grate B - Chrome	Grate D	
	Frame = 3/4" - 19 mm	Frame = 1-1/8" - 30 mm	Frame = 3/4" - 19 mm	Frame = 3/4" - 19 mm	Frame = 1-1/8" - 30 mm	Frame = 3/4" - 19 mm	For use with channel body with center outlet	For use with channel body with off-set outlet
19-11/16 - 50	KLAR 19 EB 50	KLAR 30 EB 50	KLAR 19 EP 50	KLB 19 EB 50	KLB 30 EB 50	KLB 19 EP 50	KLDRE 50	-
23-5/8 - 60	KLAR 19 EB 60	KLAR 30 EB 60	KLAR 19 EP 60	KLB 19 EB 60	KLB 30 EB 60	KLB 19 EP 60	KLDRE 60	-
27-9/16 - 70	KLAR 19 EB 70	KLAR 30 EB 70	KLAR 19 EP 70	KLB 19 EB 70	KLB 30 EB 70	KLB 19 EP 70	KLDRE 70	KLDRO E 70
31-1/2 - 80	KLAR 19 EB 80	KLAR 30 EB 80	KLAR 19 EP 80	KLB 19 EB 80	KLB 30 EB 80	KLB 19 EP 80	KLDRE 80	KLDRO E 80
35-7/16 - 90	KLAR 19 EB 90	KLAR 30 EB 90	KLAR 19 EP 90	KLB 19 EB 90	KLB 30 EB 90	KLB 19 EP 90	KLDRE 90	KLDRO E 90
39-3/8 - 100	KLAR 19 EB 100	KLAR 30 EB 100	KLAR 19 EP 100	KLB 19 EB 100	KLB 30 EB 100	KLB 19 EP 100	KLDRE 100	KLDRO E 100
43-5/16 - 110	KLAR 19 EB 110	KLAR 30 EB 110	KLAR 19 EP 110	KLB 19 EB 110	KLB 30 EB 110	KLB 19 EP 110	KLDRE 110	KLDRO E 110
47-1/4 - 120	KLAR 19 EB 120	KLAR 30 EB 120	KLAR 19 EP 120	KLB 19 EB 120	KLB 30 EB 120	KLB 19 EP 120	KLDRE 120	KLDRO E 120
51-3/16 - 130	KLAR 19 EB 130	-	-	KLB 19 EB 130	-	-	KLDRE 130	-
55-1/8 - 140	KLAR 19 EB 140	-	-	KLB 19 EB 140	-	-	KLDRE 140	-
59-1/16 - 150	KLAR 19 EB 150	-	-	KLB 19 EB 150	-	-	KLDRE 150	-
62-15/16 - 160	KLAR 19 EB 160	-	-	KLB 19 EB 160	-	-	KLDRE 160	-
66-7/8 - 170	KLAR 19 EB 170	-	-	KLB 19 EB 170	-	-	KLDRE 170	-
70-13/16 - 180	KLAR 19 EB 180	-	-	KLB 19 EB 180	-	-	KLDRE 180	-

KERDI-LINE is listed by ICC-ES (Report No. PMG-1204), UPC®, CSA, and NSF. **Note:** Purchase bonding flange and grate assembly separately.

Schluter®-KERDI Prefabricated Substrates

Prefabricated substrates are made of expanded polystyrene foam, for use in conjunction with the KERDI waterproofing membrane. KERDI-BOARD prefabricated substrates are made of KERDI-BOARD, and are waterproof and ready for tile. A pre-cut section of KERDI matching the dimensions of the tray is included with the KERDI-SHOWER-ST for convenience. Prefabricated substrates provide an alternative to shower bases constructed of mortar and other shower elements constructed of framing and solid backing. KERDI-BOARD-SB prefabricated triangular benches include KERDI-KERECK and KERDI-KERS-B preformed waterproofing corners. KERDI-BOARD-SB rectangular benches include KERDI-KERECK preformed waterproofing corners.

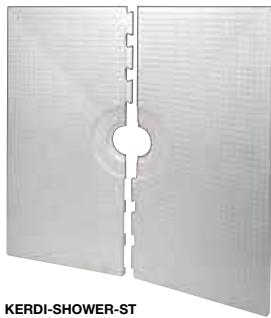

KERDI-SHOWER-ST shower tray



KERDI-SHOWER-L/-LS shower trays



KERDI-BOARD Benches



KERDI-SHOWER Benches



Curbs



Ramp



Niches

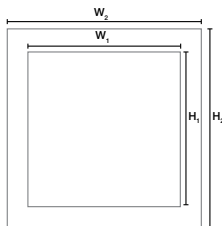

KERDI-SHOWER-ST shower tray for use with KERDI-DRAIN

Item No.	Dimensions	Drain Placement
ST-97	38" x 38" (97 cm x 97 cm)	Center
ST 122	48" x 48" (122 cm x 122 cm)	Center
ST-122/183	48" x 72" (122 cm x 183 cm)	Center
ST-183	72" x 72" (183 cm x 183 cm)	Center
ST-81/152	32" x 60" (81 cm x 152 cm)	Center
ST-81/152 BR	32" x 60" (81 cm x 152 cm)	Off-center

KERDI-SHOWER-L/-LS shower tray for use with KERDI-LINE

KSL 1000 S	39" x 39" (100 cm x 100 cm)	Wall
KSL 1400 S	55" x 55" (140 cm x 140 cm)	Wall
KSL 1000	39" x 39" (100 cm x 100 cm)	Center
KSL 1400	55" x 55" (140 cm x 140 cm)	Center

KERDI-BOARD-SB shower bench

Item No.	Dimensions	Shape
KB SB 410TA	22-5/8" x 16" x 20" (57.5 cm x 41 cm x 51 cm)	Triangular
KB SB 610TA	34" x 24" x 20" (86 cm x 61 cm x 51 cm)	Triangular
KB SB 290 970 RA	38" x 11-1/2" x 20" (97 cm x 29 cm x 51 cm)	Rectangular
KB SB 410 1220 RA	48" x 16" x 20" (122 cm x 41 cm x 51 cm)	Rectangular

KERDI-SHOWER-SB shower bench

Item No.	Dimensions	Shape
SB 41	16" x 16" x 20" (41 cm x 41 cm x 51 cm)	Triangular
SB 2981	32" x 11-1/2" x 20" (81 cm x 29 cm x 51 cm)	Rectangular
SB 29107	42" x 11-1/2" x 20" (107 cm x 29 cm x 51 cm)	Rectangular
SB 29122	48" x 11-1/2" x 20" (122 cm x 29 cm x 51 cm)	Rectangular
SB 4181	32" x 16" x 20" (81 cm x 41 cm x 51 cm)	Rectangular
SB 41122	48" x 16" x 20" (122 cm x 41 cm x 51 cm)	Rectangular

KERDI-BOARD-SC shower curb

Item No.	Dimensions
KB SC 115 150 970	4-1/2" x 38" x 6" (11.5 cm x 97 cm x 15 cm)
KB SC 115 150 1220	4-1/2" x 48" x 6" (11.5 cm x 122 cm x 15 cm)

KERDI-SHOWER-SC shower curb

Item No.	Dimensions
SC 122	4-1/2" x 48" x 6" (11.5 cm x 122 cm x 15 cm)

KERDI-SHOWER-SR shower ramp

Item No.	Dimensions
SR 122	48" x 15-7/8" (122 cm x 40 cm)

KERDI-BOARD-SN prefabricated shower niche

Item No.	W_1	H_1	W_2	H_2	Depth	Shelf
KB 12 SN 305 152 A	12" (305 mm)	6" (152 mm)	16" (406 mm)	10" (250 mm)	3-1/2" (8.9 cm)	-
KB 12 SN 305 305 A	12" (305 mm)	12" (305 mm)	16" (406 mm)	16" (406 mm)	3-1/2" (8.9 cm)	-
KB 12 SN 305 508 A1	12" (305 mm)	20" (508 mm)	16" (406 mm)	24" (610 mm)	3-1/2" (8.9 cm)	1
KB 12 SN 305 711 A1	12" (305 mm)	28" (711 mm)	16" (406 mm)	32" (810 mm)	3-1/2" (8.9 cm)	1

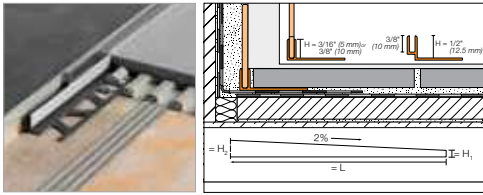

SHOWERPROFILE-S

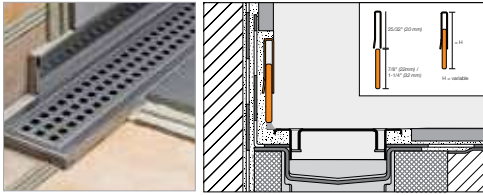

SHOWERPROFILE-R

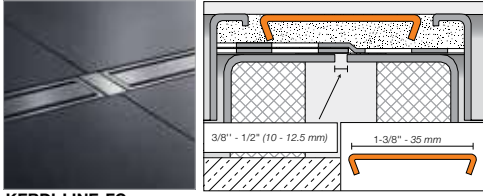

KERDI-LINE-FC

Schluter®-Systems Shower Profiles

SHOWERPROFILE-S tapered edging profile				
Item No.	H	H ₁	H ₂	Length
SPSA 50 EB/120	3/16" (5 mm)	1/4" (6 mm)	1-3/16" (30 mm)	47-1/4" (1.2 m)
SPSA 50 EB/160	3/16" (5 mm)	1/4" (6 mm)	1-1/2" (38 mm)	63" (1.6 m)
SPSA 50 EB/200	3/16" (5 mm)	1/4" (6 mm)	1-13/16" (46 mm)	78-3/4" (2 m)
SPSB 100 EB/120	3/8" (10 mm)	3/8" (10 mm)	1-11/32" (34 mm)	47-1/4" (1.2 m)
SPSB 100 EB/160	3/8" (10 mm)	3/8" (10 mm)	1-1/2" (38 mm)	63" (1.6 m)
SPSB 100 EB/200	3/8" (10 mm)	3/8" (10 mm)	2" (50 mm)	78-3/4" (2 m)
SPSB 125 EB/120	1/2" (12.5 mm)	3/8" (10 mm)	1-11/32" (34 mm)	47-1/4" (1.2 m)
SPSB 125 EB/160	1/2" (12.5 mm)	3/8" (10 mm)	1-1/2" (38 mm)	63" (1.6 m)
SPSB 125 EB/200	1/2" (12.5 mm)	3/8" (10 mm)	2" (50 mm)	78-3/4" (2 m)
SHOWERPROFILE-R edging profile				
Item No.	Height		Length	
SPRA 23 EB/100	29/32" - 1-3/8" (23 mm - 35 mm)		39" (1 m)	
SPRA 23 EB/140	29/32" - 1-3/8" (23 mm - 35 mm)		55" (1.4 m)	
SPRA 33 EB/100	1-5/16" - 1-25/32" (33 mm - 45 mm)		39" (1 m)	
SPRA 33 EB/140	1-5/16" - 1-25/32" (33 mm - 45 mm)		55" (1.4 m)	
KERDI-LINE-FC cover plate				
Item No.	Width			
V / KLEB 35	1-3/8" (35 mm)			

Schluter®-SHOWERPROFILE-WS



SHOWERPROFILE-WS + -WSL



SHOWERPROFILE-WS + -WSC

Schluter®-SHOWERPROFILE-WS	
Satin anodized aluminum support profile	
H = in. - mm	Item No.
L = 39" - 1 m	
5/16 - 8	SPWS 19 AE / 100
L = 8' 2-1/2" - 2.5 m	
5/16 - 8	SPWS 19 AE

Schluter®-SHOWERPROFILE-WSL	
Straight lip	
H = in. - mm	Item No.
L = 39" - 1 m	
5/16 - 8	SPWSL 30 T / 100
L = 8' 2-1/2" - 2.5 m	
5/16 - 8	SPWSL 30 T

Schluter®-SHOWERPROFILE-WSC	
Semi-circular lip	
H = in. - mm	Item No.
L = 39" - 1 m	
5/16 - 8	SPWSC 16 GS / 100
L = 8' 2-1/2" - 2.5 m	
5/16 - 8	SPWSC 16 GS

ADA-Compliant

Note: SHOWERPROFILE-WS with the WSL straight lip insert is not ADA-compliant.

Schluter®-SHOWERPROFILE-WSK

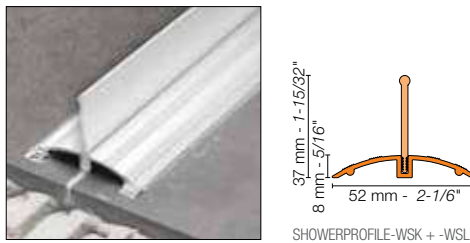

SHOWERPROFILE-WSK + -WSL

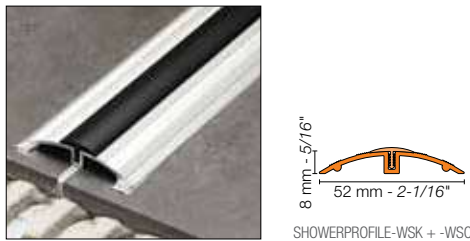

SHOWERPROFILE-WSK + -WSC

Schluter®-SHOWERPROFILE-WSK	
Satin anodized aluminum support profile	
H = in. - mm	Item No.
L = 39" - 1 m	
5/16 - 8	SPWSK 52 AE / 100
L = 8' 2-1/2" - 2.5 m	
5/16 - 8	SPWSK 52 AE

Schluter®-SHOWERPROFILE-WSL	
Straight lip	
H = in. - mm	Item No.
L = 39" - 1 m	
5/16 - 8	SPWSL 30 T / 100
L = 8' 2-1/2" - 2.5 m	
5/16 - 8	SPWSL 30 T

Schluter®-SHOWERPROFILE-WSC	
Semi-circular lip	
H = in. - mm	Item No.
L = 39" - 1 m	
5/16 - 8	SPWSC 16 GS / 100
L = 8' 2-1/2" - 2.5 m	
5/16 - 8	SPWSC 16 GS

Schluter®-SHOWERPROFILE-WSK-EK	
End cap	
H = in. - mm	Item No.
5/16 - 8	EK / SPWSK 52 AE

ADA-Compliant

Note: SHOWERPROFILE-WSK with the WSL straight lip insert is not ADA-compliant.



SHOWERPROFILE-WSK-EK

Schluter®-KERDI-SHOWER-KIT

The **KERDI-SHOWER-KIT** is an all-inclusive package containing the components required to create a watertight shower assembly without a mortar bed.



Schluter®-KERDI-SHOWER-KIT		Quantity				
Includes	Description					
		48" x 48"	72" x 72"	32" x 60"	38" x 38"	48" x 72"
1	KERDI-SHOWER-ST Shower Tray	1	1	1	1	1
2	KERDI-SHOWER-SC Shower Curb 48" x 6" x 4-1/2"	1	2	2	1	2
3	KERDI 5 M Waterproofing membrane 3' 3" x 16' 5" = 54 ft²					1
	KERDI 10 M Waterproofing membrane 3' 3" x 33' = 108 ft²			1	1	1
	KERDI 12 M Waterproofing membrane 3' 3" x 39' 4" = 128 ft²	1				
	KERDI 20 M Waterproofing membrane 3' 3" x 65' 7" = 215 ft²		1			
4	KERDI-BAND Waterproofing strip 5" x 33'	1	2	1	1	2
5	KERDI-DRAIN Drain, with integrated bonding flange with 2" (50 mm) outlet	1	1	1	1	1
6	KERDI-KERECK-F Preformed waterproofing corners	4 inside and 2 outside				
7	KERDI-SEAL-PS Pipe seal (3/4" - 20 mm)		1		1	1
8	KERDI-SEAL-MV Mixing valve seal		1		1	1

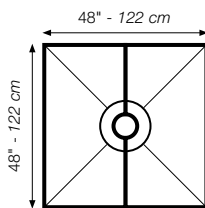

48" x 48" (122 cm x 122 cm) Kit		
Select material for drain (ABS or PVC) and grate finish		
Item No.	Drain Material	Grate finish
KK 122 ABS E	ABS	Stainless steel 304 (1.4301 = V2A)
KK 122 ABS EP	ABS	Chrome
KK 122 PVC E	PVC	Stainless steel 304 (1.4301 = V2A)
KK 122 PVC EP	PVC	Chrome

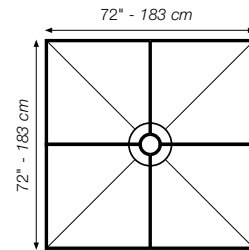

72" x 72" (183 cm x 183 cm) Kit		
Select material for drain (ABS or PVC) and grate finish		
Item No.	Drain Material	Grate finish
KK 183 ABS E	ABS	Stainless steel 304 (1.4301 = V2A)
KK 183 ABS EP	ABS	Chrome
KK 183 PVC E	PVC	Stainless steel 304 (1.4301 = V2A)
KK 183 PVC EP	PVC	Chrome

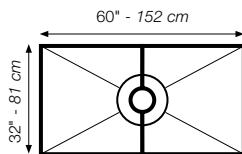

32" x 60" (81 cm x 152 cm) Kit		
Select material for drain (ABS or PVC) and grate finish		
Item No.	Drain Material	Grate finish
KK 81152 ABS E	ABS	Stainless steel 304 (1.4301 = V2A)
KK 81152 ABS EP	ABS	Chrome
KK 81152 PVC E	PVC	Stainless steel 304 (1.4301 = V2A)
KK 81152 PVC EP	PVC	Chrome

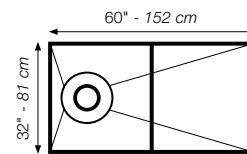

32" x 60" (81 cm x 152 cm) Kit		
Select material for drain (ABS or PVC) and grate finish		
Item No.	Drain Material	Grate finish
KKB 81152 ABS E	ABS	Stainless steel 304 (1.4301 = V2A)
KKB 81152 ABS EP	ABS	Chrome
KKB 81152 PVC E	PVC	Stainless steel 304 (1.4301 = V2A)
KKB 81152 PVC EP	PVC	Chrome

Note: Tray features off-center drain placement: 10" (25.4 cm) o.c. from end of tray.

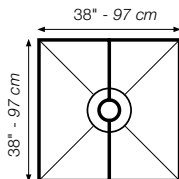

38" x 38" (97 cm x 97 cm) Kit		
Select material for drain (ABS or PVC) and grate finish		
Item No.	Drain Material	Grate finish
KK 97 ABS E	ABS	Stainless steel 304 (1.4301 = V2A)
KK 97 ABS EP	ABS	Chrome
KK 97 PVC E	PVC	Stainless steel 304 (1.4301 = V2A)
KK 97 PVC EP	PVC	Chrome

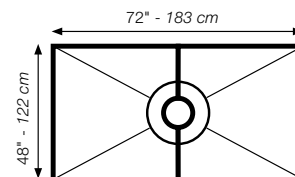

48" x 72" (122 cm x 183 cm) Kit		
Select material for drain (ABS or PVC) and grate finish		
Item No.	Drain Material	Grate finish
KK 122183 ABS E	ABS	Stainless steel 304 (1.4301 = V2A)
KK 122183 ABS EP	ABS	Chrome
KK 122183 PVC E	PVC	Stainless steel 304 (1.4301 = V2A)
KK 122183 PVC EP	PVC	Chrome

Note: The KERDI-SHOWER-KIT is also available without the drain. This kit contains the same components as the complete KERDI-SHOWER-KIT, except the KERDI-DRAIN which must be purchased separately. This kit allows you to select the drain that is best suited to your application (i.e. KERDI-DRAIN with 3" outlet or KERDI-DRAIN with adaptor ring).

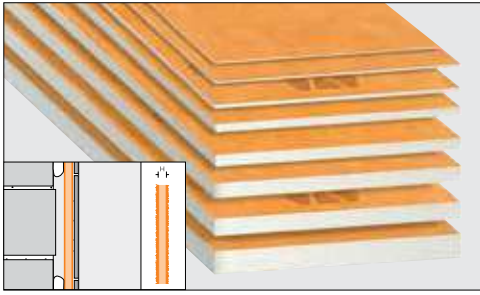

Schluter®-KERDI-BOARD

KERDI-BOARD is a multifunctional tile substrate and building panel, which can also be used for creating bonded waterproofing assemblies with tile coverings. It consists of an extruded polystyrene foam panel, with a special reinforcement material on both sides and fleece webbing for effective anchoring in thin-set mortar.

The boards are simply cut to size with a utility knife. The gridlines, which are printed on the surface, are helpful for neat and quick cuts and installation. Tiles can be installed directly over KERDI-BOARD using the thin-set method.

Additional panels and accessories

Please refer to our Illustrated Price List for details.

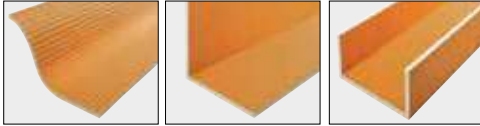

Grooved panels

L-shaped panels

U-shaped panels



Profiles

Anchors

Washers, screws
and adhesive tape

Schluter®-KERDI-BOARD	
Substrate and building panel	
H =	Item No.
Panel dimension: 32" x 48" (81 cm x 122 cm)	
1/2" (12.5 mm)	KB 12 1220 812
Panel dimension: 48" x 64" (122 cm x 162.5 cm)	
3/16" (5 mm)	KB 5 1220 1625
3/8" (9 mm)	KB 9 1220 1625
1/2" (12.5 mm)	KB 12 1220 1625
Panel dimension: 48" x 96" (122 cm x 244 cm)	
3/16" (5 mm)	KB 5 1220 2440
3/8" (9 mm)	KB 9 1220 2440
1/2" (12.5 mm)	KB 12 1220 2440
5/8" (15 mm)	KB 15 1220 2440
Panel dimension: 24-1/2" x 96" (62.5 cm x 244 cm)	
3/4" (19 mm)	KB 19 625 2440
1" (25 mm)	KB 25 625 2440
1-1/2" (38 mm)	KB 38 625 2440
2" (50 mm)	KB 50 625 2440
Panel dimension: 48" x 120" (122 cm x 305 cm)	
5/8" (15 mm)	KB 15 1220 3050



DITRA and DITRA-XL are listed by cUPC® and evaluated by ICC-ES (Report Nos. ESR-2467 and PMG-1204).

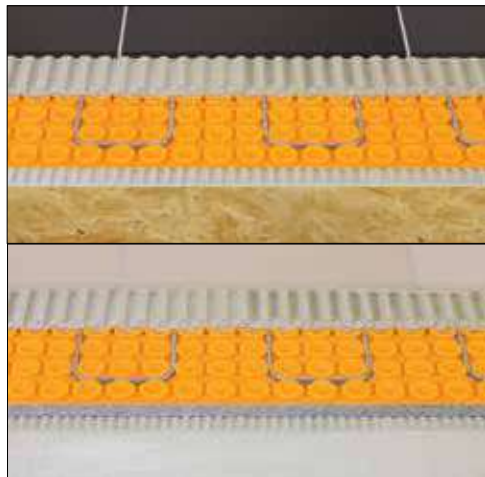

DITRA-HEAT and DITRA-HEAT-DUO are evaluated by ICC-ES (Report Nos. ESR-2467 and PMG-1204).

Schluter®-DITRA and Schluter®-DITRA-HEAT

DITRA is a pressure-stable polyethylene uncoupling membrane, vacuum-formed in a cutback grid design, with an anchoring fleece laminated to its underside. DITRA is 1/8" (3 mm) in height. **DITRA-XL** is 5/16" (7 mm) in height. **DITRA-HEAT** is a polypropylene membrane with a cut-back stud structure and an anchoring fleece laminated to the underside. The matting is 1/4" (5.5 mm) in height. **DITRA-HEAT-DUO** offers the same functions as DITRA-HEAT, but features a thicker bonding fleece that adds sound control and thermal break. The matting is 5/16" (8 mm) thick. The thermal break fleece reduces heat loss to the substrate to improve floor warming response time. The stud structure is specifically designed to secure **DITRA-HEAT-E-HK** electric floor heating cables.

Schluter®-DITRA	
Item No.	Packaging
DITRA uncoupling and waterproofing membrane (1/8" - 3 mm thick)	
DITRA 5M	3' 3" x 16' 5" = 54 ft ² (1 m x 5 m = 5 m ²)
DITRA 150	3' 3" x 45' 9" = 150 ft ² (1 m x 14 m = 14 m ²)
DITRA 30	3' 3" x 98' 5" = 323 ft ² (1 m x 30 m = 30 m ²)
DITRA-XL uncoupling and waterproofing membrane (5/16" - 7 mm thick)	
DITRA-XL/175	3' 3" x 53' 3" = 175 ft ² (1 m x 16.25 m = 16.25 m ²)

U.S. Patent No. 6,434,901 Canadian Patent No. 2,329,620

Schluter®-DITRA-HEAT		
Uncoupling and waterproofing membrane		
Item No.	Dimensions	Format
DH5 12M	3' 3" x 41' 1" = 134.5 ft ² (1 m x 12.5 m = 12.5 m ²)	Roll
DH5 MA	3' 3" x 2' 7" = 8.6 ft ² (1 m x 0.8 m = 0.8 m ²)	Sheet

U.S. Pat. No. 8,950,141, and U.S. DES. PAT. No. D706459. Canada © Schluter-Systems L.P. and other patents pending.

Schluter®-DITRA-HEAT-DUO		
Uncoupling and waterproofing membrane with sound control and thermal break		
Item No.	Dimensions	Format
DHD 810 M	3' 3" x 33' = 108 ft ² (1 m x 10 m = 10 m ²)	Roll
DHD 8 MA	3' 3" x 2' 7" = 8.6 ft ² (1 m x 0.8 m = 0.8 m ²)	Sheet

Patent pending



Schluter® Thin-set Mortar

Specifically formulated for use with Schluter® membranes and boards, Schluter® thin-set mortars are sag-resistant, smooth and creamy, and easy to handle and spread. They are suitable for use with ceramic, porcelain, and stone tile, including large and heavy tile.

Schluter SET™ is a premium unmodified thin-set mortar. SET™ meets the requirements of ANSI A118.1T.

Schluter ALL-SET™ is a specialized modified thin-set mortar. ALL-SET™ meets the requirements of ANSI A118.4T, A118.11, and A118.15T.

Schluter FAST-SET™ is a specialized rapid-setting modified thin-set mortar. FAST-SET™ meets the requirements of ANSI A118.4TF, A118.11, and A118.15TF.

Schluter SET™		
Premium unmodified mortar		
Item No.	Color	Weight
SET50G	Grey	50 lbs - 22.7 kg
SET50W	White	50 lbs - 22.7 kg

Schluter ALL-SET™		
Specialized modified mortar		
Item No.	Color	Weight
SETA50G	Grey	50 lbs - 22.7 kg
SETA50W	White	50 lbs - 22.7 kg

Schluter FAST-SET™		
Specialized rapid-setting mortar		
Item No.	Color	Weight
SETF50G	Grey	50 lbs - 22.7 kg
SETF50W	White	50 lbs - 22.7 kg



Schluter®-TROWEL

The **Schluter®-DITRA-TROWEL** features a 11/64" x 11/64" (4.5 mm x 4.5 mm) square-notched design, and is used to install the DITRA membrane.

The **Schluter®-DITRA-HEAT/-DITRA-XL-TROWEL** features a 1/4" x 1/4" (6 mm x 6 mm) square-notched design, and is used to install the DITRA-HEAT and DITRA-XL membranes.

The **Schluter®-KERDI-TROWEL** features a 1/8" x 1/8" (3 mm x 3 mm) square-notched design, and is used to install the KERDI membrane.

Schluter®-TROWEL		
Trowels used to install Schluter®-DITRA, DITRA-XL and DITRA-HEAT, and KERDI membranes		
Item No.	Notch Size	Packaging
Schluter®-DITRA-TROWEL		
TRL-DIT	11/64" x 11/64" (4.5 mm x 4.5 mm)	1 unit
TRL-DIT6	11/64" x 11/64" (4.5 mm x 4.5 mm)	6 units
Schluter®-KERDI-TROWEL		
TRL-KER	1/8" x 1/8" (3 mm x 3 mm)	1 unit
TRL-KER6	1/8" x 1/8" (3 mm x 3 mm)	6 units
Schluter®-DITRA-HEAT/-DITRA-XL-TROWEL		
TRL-DHXL	1/4" x 1/4" (6 mm x 6 mm)	1 unit
TRL-DHXL6	1/4" x 1/4" (6 mm x 6 mm)	6 units

WARRANTIES

Schluter®-Shower System 10-Year Limited Warranty

COVERAGE AND CONDITIONS: Subject to the conditions and limitations as stated hereinafter, **Schluter®-Systems*** warrants that the **Schluter®-Shower System** (the “Products”)** will meet all composition and performance criteria for a period of ten (10) years from the date of purchase only when the Products are used and installed in accordance with the terms and conditions of the Schluter®-Shower System Installation Handbook and industry standard guidelines that are not in conflict with the Handbook in effect at the time of installation. Further, efflorescence is considered to be a natural occurrence with cementitious materials and is therefore not considered to be a defective condition and is not covered by this warranty. It is the responsibility of the owner/builder/installer to ensure the suitability of all building materials and all associated building materials for the owner’s intended use. It is recommended that the owner consult with an experienced and professional installer.

RESOLUTION: If the Products fail to meet this warranty, then the owner’s exclusive remedy and the sole obligation of Schluter®-Systems, at its election, shall be to a) reinstall or replace the failed portion of the tile assembly or b) pay an amount not to exceed the original square foot cost of the installation of the tile assembly verified to be defective. Tile assembly is defined to include all Schluter®-KERDI products, non-reusable tile surfaces, and the appropriate setting and grouting materials. Further, due to conditions beyond the control of Schluter®-Systems (e.g., color and shade availability, discontinuation, normal wear and tear), Schluter®-Systems cannot guarantee or warrant an exact match to the specific tile, stone, or other covering materials used in the installation. In such events, substantially similar materials may be substituted.

DISCLAIMER: THERE ARE NO WARRANTIES BEYOND THIS EXPRESSED WARRANTY AS STATED ABOVE. ALL OTHER WARRANTIES, REPRESENTATIONS OR CONDITIONS, EXPRESSED OR IMPLIED, ARE DISCLAIMED AND EXCLUDED, INCLUDING WARRANTIES, REPRESENTATIONS OR CONDITIONS OF **MERCHANTABILITY** OR FITNESS FOR A PARTICULAR PURPOSE ARISING BY STATUTE OR OTHERWISE BY LAW OR FROM A COURSE OF DEALING OR USAGE OF TRADE. SCHLUTER®-SYSTEMS EXCLUDES AND IN NO EVENT SHALL HAVE ANY LIABILITY FOR LOST PROFITS OR ANY OTHER INDIRECT, SPECIAL, INCIDENTAL, PUNITIVE, EXEMPLARY, OR CONSEQUENTIAL DAMAGES, ARISING OUT OF OR OTHERWISE CONNECTED TO FAILURE OF THE PRODUCTS, NOR MISUSE OF THE PRODUCTS OR FAILURE TO PROPERLY MAINTAIN THE SHOWER OR BATHTUB SURROUND. REGARDLESS OF ANY STRICT LIABILITY, ACTIVE OR PASSIVE NEGLIGENCE OF SCHLUTER®-SYSTEMS, AND REGARDLESS OF THE LEGAL THEORY (CONTRACT OR TORT OR EXTRA-CONTRACTUAL OR OTHER), NOR FROM ACTS OF WAR, TERRORISM, FAULTY AND NEGLIGENT PENETRATION OF THE SYSTEM, FIRES, EXPLOSIONS, ACTS OF GOD, INTENTIONAL ACTS OF DESTRUCTION OR ANY LOSSES DUE TO STRUCTURAL FAILURE OR OTHER CAUSES UNRELATED TO THE PRODUCTS OR DELAYS, OR ANY OTHER INCIDENTAL OR CONSEQUENTIAL DAMAGES. THIS WARRANTY IS GIVEN IN LIEU OF ANY OTHER WARRANTY EXPRESSED OR IMPLIED. THE REMEDIES CONTAINED HEREIN ARE THE ONLY REMEDIES AVAILABLE FOR BREACH OF THIS WARRANTY. THIS LIMITED WARRANTY GIVES YOU SPECIFIC LEGAL RIGHTS; SOME STATES AND PROVINCES DO NOT ALLOW DISCLAIMERS OR OTHER RESTRICTIONS OF IMPLIED WARRANTIES, SO SOME OF THE ABOVE DISCLAIMERS MAY NOT APPLY TO YOU.

TRANSFERABILITY: This Limited Warranty extends ONLY to the original end user (defined as original intended owner and user of the property/unit in which the installation is incorporated - herein referred to as “Owner”) and is not transferable or assignable, unless approved in writing by the Schluter Systems Technical Services Director or an Officer of Schluter®-Systems or otherwise prohibited by specific state or provincial law.

MODIFICATIONS TO WARRANTY: No changes or modification of any terms or conditions of this warranty are allowed unless authorized by written agreement and signed by the Schluter Systems Technical Services Director or an Officer of Schluter®-Systems.

EFFECTIVE DATE: This warranty shall supersede and replace any and all prior oral or written warranties, agreements, or other such representations made by or on behalf of Schluter®-Systems relative to the Products or the application of the Products and shall apply to any installation occurring on or after October 1, 2017.

CLAIMS ON THIS LIMITED WARRANTY: To make a claim under this Limited Warranty, the Owner must provide Schluter®-Systems with written notice within 30 days of any alleged defect in the Products covered by this Limited Warranty, together with date and proof of purchase of the Products, proof of the costs of the original installation and name and address of all installers, failing which this Limited Warranty shall be of no legal effect. Schluter®-Systems reserves the right at its election and as a condition of this Limited Warranty to inspect the alleged failed and defective condition.

All U.S. Claims shall be sent to:

Schluter Systems L.P.
Attn: Warranty Claims Dept.
194 Pleasant Ridge Road
Plattsburgh, NY 12901-5841

All Canadian Claims shall be sent to:

Schluter Systems (Canada), Inc.
Attn: Warranty Claims Dept.
21100 chemin Ste-Marie
Ste-Anne-de-Bellevue, QC H9X 3Y8

*For the purpose of this warranty **Schluter Systems, L.P.** shall provide the warranty for all products for end users located in the United States, and **Schluter Systems (Canada) Inc.** shall provide the warranty for all products for end users located in Canada. This warranty is limited to sales of the Products made in and intended for use in the United States and Canada.

****Schluter®-Shower System (the “Products”):** The Products are defined to include all Schluter®-KERDI products referred to in the Handbook and used in the integrated Schluter®-Shower System.

Schluter®-Systems Lifetime Thin-Set System Extended Limited Warranty

LIMITED WARRANTY COVERAGE: Subject to the conditions and limitations as stated in this **Lifetime Thin-Set System Extended Limited Warranty** (the "**Limited Warranty**"), Schluter Systems warrants that a Thin-Set System (defined hereafter) will be free from manufacturing defects and will perform as described in the applicable installation handbook(s) and/or technical data sheet(s) (collectively, the "**Written Materials**") for the lifetime (defined hereafter) of such Thin-Set System when installed in a Residential or Commercial application (defined hereafter) and used in accordance with the terms and conditions of the Written Materials and industry standard guidelines that are not in conflict with the Written Materials in effect at the time of installation. In order to extend warranty coverage for Schluter® DITRA® or DITRA®-XL uncoupling membranes, Schluter®-Shower System, Schluter® KERDI® or KERDI®-DS waterproofing membranes, or Schluter® DITRA-HEAT™ or Schluter® DITRA-HEAT-DUO™ uncoupling membrane to lifetime coverage under this Lifetime Thin-Set System Extended Limited Warranty, Owner must complete and submit the Thin-Set System Registration to Schluter Systems, available at www.schluter.com, or submit proof of purchase and installation information (including installation date, installer's name and address) to Schluter Systems at the address provided hereafter within ninety (90) days of installation.

For the purposes of this Limited Warranty, a "**Thin-Set System**" is defined as Schluter® DITRA® or DITRA®-XL uncoupling membranes, Schluter®-Shower System, Schluter®-KERDI®-BOARD within a Schluter®-Shower System, Schluter® KERDI® or KERDI®-DS waterproofing membranes, or Schluter® DITRA-HEAT™ or Schluter® DITRA-HEAT-DUO™ uncoupling membrane installed with Schluter SET™, Schluter ALL-SET™, or Schluter FAST-SET™ thin-set mortar; "**Owner**" is defined as the original end user of the property in which a Thin-Set System is installed; "**Lifetime**" is defined as that period of time that the original Thin-Set System installation remains unchanged and under the ownership of the Owner; "**Residential**" applications are defined to include Thin-Set System installations in single family detached residential dwellings; and "**Commercial**" applications are defined to include Thin-Set System installations in multi-family residential dwellings (e.g., apartments, condominiums, cooperatives, and timeshares). Thin-Set System installations in public places, commercial establishments and other applications may be afforded lifetime coverage under this Limited Warranty on a case by case basis as determined by the Schluter Systems Technical Services Director.

This Limited Warranty is only applicable to installations in the United States of America and Canada. Schluter Systems is not responsible or liable under any circumstances for determining the suitability of a Thin-Set System for the Owner's intended purpose. It is the responsibility of the Owner to consult with an experienced and professional installer to ensure the suitability of a Thin-Set System, subfloor/substrate and all building materials in the installation and that the Written Materials are followed properly.

RESOLUTION: If a Thin-Set System is installed and used in accordance with the terms and conditions as described hereinabove and such Thin-Set System is proven defective within the applicable warranty term, the Owner's exclusive remedy and the sole obligation of Schluter Systems, at its election, shall be to (a) reinstall or replace the failed portion of the Thin-Set System or (b) pay an amount not to exceed the original square foot cost of the installation of the Thin-Set System verified to be defective. Due to conditions beyond the control of Schluter Systems (e.g., color and shade availability, discontinuation, normal wear and tear), Schluter Systems cannot guarantee or warrant an exact match to the specific tile, stone, or other flooring materials used in the original installation. In such event, substantially similar materials may be substituted.

EXCLUSIONS FROM COVERAGE: This Limited Warranty excludes and in no event shall Schluter Systems have any liability for any indirect, special, incidental, punitive, exemplary, or consequential damages, including lost profits, arising out of or otherwise connected to the failure of a Thin-Set System, regardless of any strict liability or active or passive negligence of Schluter Systems, and regardless of legal theory, whether in contract, tort, extra-contractual or other. This Limited Warranty further excludes any loss or damage arising out of or otherwise connected to: acts of war, terrorism, fire, explosion, natural disaster, acts of God, any failure to comply with the Written Materials, inadequate subfloor/substrate, improper preparation or other failure of subfloor/substrate, faulty or negligent penetration of a Thin-Set System or subfloor/substrate, intentional acts of destruction, structural failure, misuse of or failure to maintain a Thin-Set System, normal wear and tear, scratches, dents, corrosion or discoloration (whether caused by excessive heat, chemical cleaning products, abrasive agents or otherwise), efflorescence and shading which are a natural occurrence with cementitious materials and are not considered a defective condition for the purposes of this Limited Warranty, variations of texture, color or shade from those on product samples, packaging materials or other marketing materials, or other causes unrelated to a Thin-Set System (e.g. excess point loading, overvoltage). This Limited Warranty excludes exterior, submerged and steam room applications and further excludes applications using glass tile, resin-backed tile, and/or moisture sensitive stone unless specifically approved in writing on a case by case basis by the Schluter Systems Technical Services Director. Schluter® DITRA-HEAT™-E-HK heating cables and Schluter® DITRA-HEAT™-E thermostats are specifically excluded from coverage under this Limited Warranty. Any substitution of a non-Schluter Systems product for a Schluter Systems component in a Thin-Set System voids this Limited Warranty.

DISCLAIMER: There are no warranties beyond this expressed warranty as stated herein. To the extent permitted by law, all other warranties, representations or conditions, expressed or implied, are hereby disclaimed and excluded, including but not limited to the implied warranties of **MERCHANTABILITY** or **FITNESS FOR A PARTICULAR PURPOSE** (as limited to such purposes as described in the Written Materials) or arising from a course of dealing, usage of trade or otherwise by law. ANY IMPLIED WARRANTIES ARISING BY OPERATION OF LAW ARE LIMITED IN DURATION TO THE TERM OF THIS LIMITED WARRANTY. NO REPRESENTATION, PROMISE, AFFIRMATION OR STATEMENT BY ANY EMPLOYEE OR AGENT OF SCHLUTER SYSTEMS WILL BE ENFORCEABLE AGAINST SCHLUTER SYSTEMS UNLESS IT IS SPECIFICALLY INCLUDED IN THIS LIMITED WARRANTY OR AUTHORIZED IN WRITING BY THE SCHLUTER SYSTEMS TECHNICAL SERVICES DIRECTOR. This Limited Warranty is given in lieu of any other warranty, whether expressed or implied. The remedies contained herein are the only remedies available for breach of this Limited Warranty. Schluter Systems excludes and in no event shall have any liability for any indirect, special, incidental, punitive, exemplary, or consequential damages, including lost profits, arising out of or otherwise connected to failure of a Thin-Set System. This Limited Warranty extends only to the Owner and is not transferable or assignable unless authorized by written agreement and signed by the Schluter Systems Technical Services Director or otherwise prohibited by specific state or provincial law. This Limited Warranty gives you specific legal rights; some states and provinces do not allow disclaimers or other restrictions of implied warranties; some of the above disclaimers may not apply to you. **No changes or modifications of any terms or conditions of this Limited Warranty are permitted unless duly authorized in writing by the Schluter Systems Technical Services Director.** This Limited Warranty shall supersede and replace any and all prior oral or written warranties, agreements, or other representations made by or on behalf of Schluter Systems relative to a Thin-Set System or the application of a Thin-Set System and shall apply to any installation occurring on or after March 13, 2017. For the most current information and materials regarding Schluter Systems warranties and programs, please visit https://www.schluter.com/schluter-us/en_US/downloadfiles.

MAKING A CLAIM: To make a claim under this Limited Warranty, the Owner must provide Schluter Systems with written notice within thirty (30) days of any alleged defect in a Thin-Set System covered by this Limited Warranty, together with date and proof of purchase of such Thin-Set System and/or all of its components and name and address of all installers and all invoices related to the original installation, failing which this Limited Warranty shall have no legal effect. Schluter Systems reserves the right at its election and as a condition of this Limited Warranty to inspect the alleged failed and/or defective Thin-Set System.

All U.S. Claims shall be sent to:

All Canadian Claims shall be sent to:

Schluter Systems L.P.
Attn: Warranty Claims Dept.
194 Pleasant Ridge Road
Plattsburgh, NY 12901-5841

Schluter Systems (Canada), Inc.
Attn: Warranty Claims Dept.
21100 chemin Ste-Marie
Ste-Anne-de-Bellevue, QC H9X 3Y8



Schluter Systems L.P. • 194 Pleasant Ridge Road, Plattsburgh, NY 12901-5841 • Tel.: 800-472-4588 • Fax: 800-477-9783
Schluter Systems (Canada) Inc. • 21100 chemin Ste-Marie, Ste-Anne-de-Bellevue, QC H9X 3Y8 • Tel.: 800-667-8746 • Fax: 877-667-2410

www.schluter.com