

EDGESTAR®

KC3000 Kegerator Installation Guide

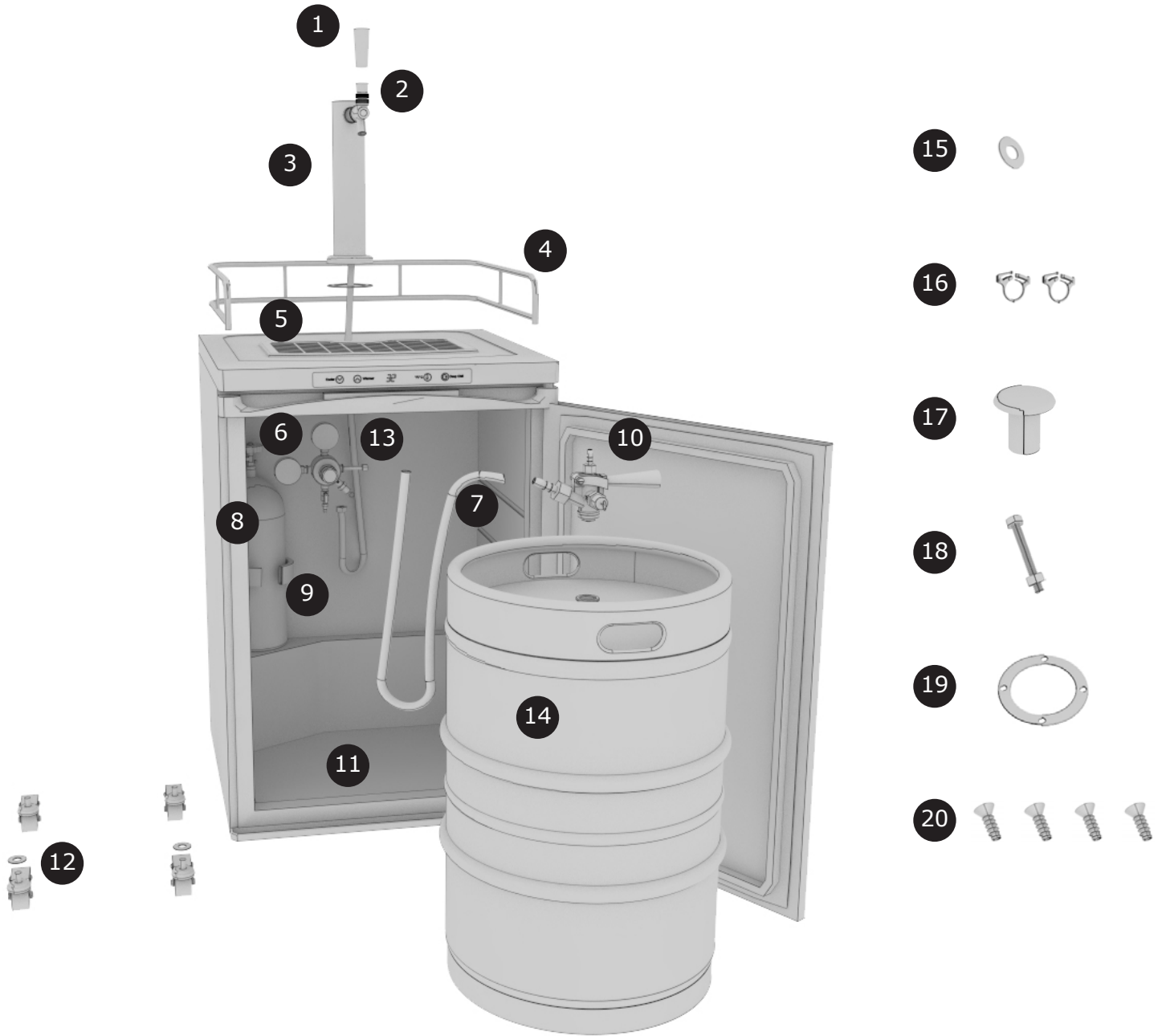

1. Faucet Handle
2. Faucet
3. Beer Tower
4. Guard Rail
5. Drip Tray
6. Regulator
7. CO2 Tube

8. CO2 Cylinder (supplied empty)
9. Cylinder Clip
10. American Sankey Keg Coupler
11. Metal Keg Floor Support
12. Casters (x4) and Washers (x2)
13. Beer Line
14. Half Barrel Keg (not included)

15. Neoprene Washer
16. Hose Clamps (2)
17. Tower Plug
18. Long Bolt and Nut
19. Tower Gasket
20. Screws (4)

Tools Needed:

- Wrench
- Flat Head Screwdriver
- Pair of Pliers/Clamp Crimper

For additional information
visit edgestar.com

1**Install Caster Wheels**

Before assembly, make sure to empty the inside of the unit including all shelves and metal keg floor (# 11). Carefully lay the unit on its back. Attach the casters (#12) into the existing holes at the bottom of the unit. The front two casters require a flat washer (part# 12) prior to installation. Next, set the unit upright and reinstall the keg floor (# 11).

Note: Allow the dispenser to stand in an upright position for 24 hours before plugging in the unit.

**2****Remove Plug**

Carefully remove the tower plug (#17) located on the top of the unit by opening the cabinet, and with your hand, push plug through the top of the cabinet from the inside. Use flat head screwdriver as a prying tool if necessary.

**3****Install Tower**

Mount the tower gasket (#19) by lining it up with the preexisting holes at the top of the unit. Install the tower (#3) by first unraveling the beer line from the bottom of the tower. Feed the beer line (#13) through the top opening that was under the cabinet plug.

**4****Secure Tower**

Once the beer line is fed into the unit line up the holes at the bottom of the tower and install the four screws (#20).

**5****Install Handle & Faucet**

Screw the faucet handle (#1) to the beer faucet (#2). Line up the beer faucet to the tower shank at the front of the tower (#3) and tighten the collar.

**6****Install Railing**

Take the railing (#4) and slide its "feet" into the pilot holes in the top of the cabinet.

**Warning:**

CO₂ can be dangerous! CO₂ cylinders contain high-pressured gas, which can be hazardous if handled improperly. Please handle with care.

7

Connect Regulator to Cylinder

Attach the CO₂ regulator (#6) to the CO₂ cylinder (#8) by screwing the regulator nut onto the cylinder valve and tightening with pliers.

Note: A fiber washer is normally required to connect a regulator to a CO₂ cylinder, but the standard regulator provided includes a built-in o-ring.



8

Connect Tube to Regulator

Make sure the shut off valve at the bottom of the regulator is closed (9 o'clock position). Install the CO₂ Tube (#7) to the hose barb at the bottom of the regulator (#6) and secure with a hose clamp (#16).



9

Mount CO₂ Cylinder

Mount the CO₂ cylinder (#8) onto the step and inside the cylinder clip (#9). Secure the tank into the clip using the long bolt and nut (#18).



10

Attach Tube to Coupler

Attach the remaining end of the CO₂ tube (#7) to hose barb on the side of the coupler (#10). Secure the tube with a hose clamp (#16).



11

Connect Beer Line

Now connect the beer line (#13) to the keg coupler (#10). Insert the neoprene washer (#15) into the beer line hex nut (the beer line is the line coming from/going to the tower and faucet). Remove the blue rubber protective cap located on top of the keg coupler and screw the nut with the rubber washer to the top of the keg coupler, hand-tighten firmly.



12

Connect Keg Coupler

To connect the keg coupler (#10) to the keg (#14), first make sure the black pull handle of the keg coupler is in the up position (45° angle). Insert the keg coupler into the valve on top of the keg and turn clockwise until it stops about 90° to lock the coupler into place. Now pull the tap handle out (away from the keg coupler) and push down until it locks into position. Listen for the "click" of the pull handle when it shifts into the final downward position. The keg is now tapped.



Note:

This manual is intended as a guide for installation. While there are many different ways to install this kit, we recommend you follow these instructions. If you are uncomfortable in your ability to assemble this kit, seek professional assistance.

- (A) With the shut-off valve on the regulator closed, open the valve on the CO2 cylinder (#8) completely.
- (B) With a pair of pliers, loosen adjustment nut allowing adjustment screw to be turned counter-clockwise until adjustment screw is completely open.
- (C) Using a flathead screwdriver, slowly turn the regulator adjustment screw clockwise until the desired pressure is shown on the pressure gauge on the top. By turning the screw clockwise it will increase (+) pressure and counterclockwise will decrease (-) pressure. Under normal circumstances, we recommend setting the regulator at 10-12psi. **NOTE:** When adjusting pressure from a high pressure to a lower pressure, you will need to release the higher pressure out by pulling the manual pressure release valve ring located on the side of the coupler.
- (D) Once the desired pressure is set, open the shut-off valve by turning the lever down (6 o'clock position or parallel to the CO2 tube). Gas should now be flowing from the regulator to the keg coupler. You will hear the keg pressurizing. The output needle will drop momentarily while the pressure is equalizing. Then, the needle will return to the point you set it at.

NOTE: Other conditions, such as altitude, beer type, and temperature may require some adjustment. It is always wise to follow up any adjustment to the regulator with a brief pull of the pressure release valve ring on the regulator or coupler to ensure an accurate output reading.

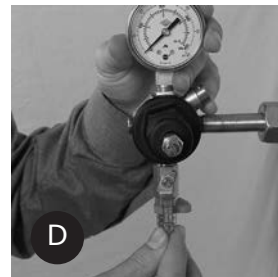
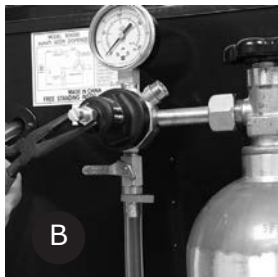
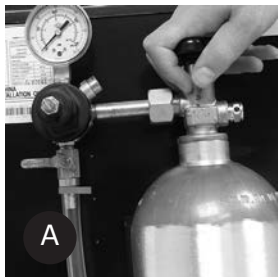

Multiple Keg Configurations

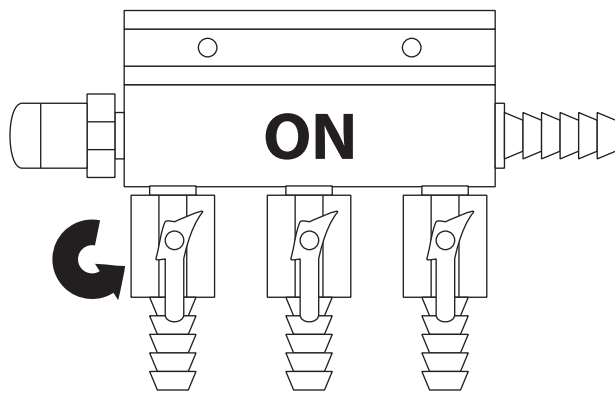
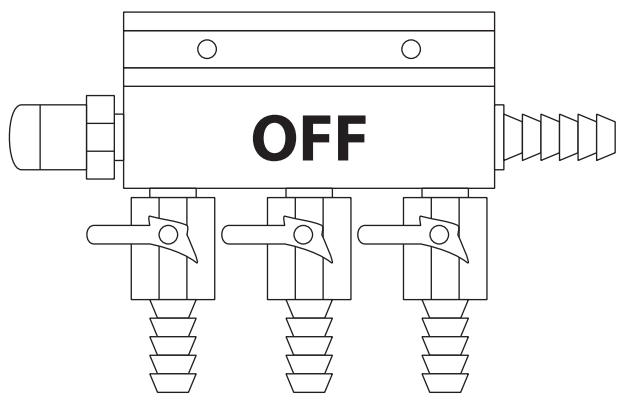
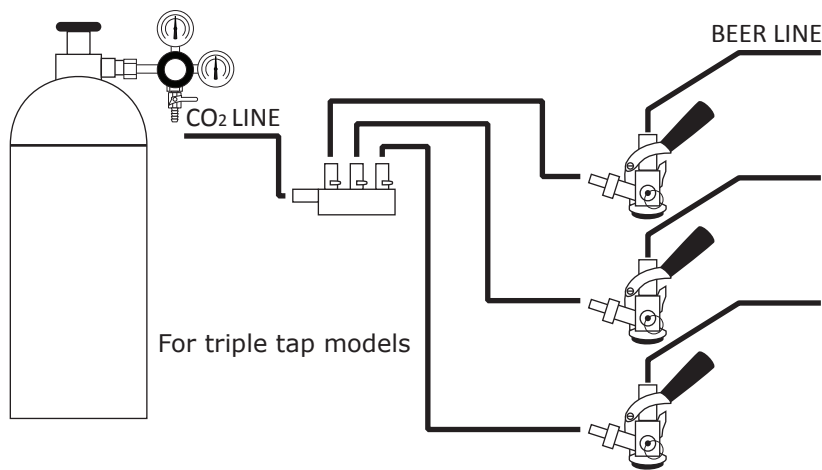
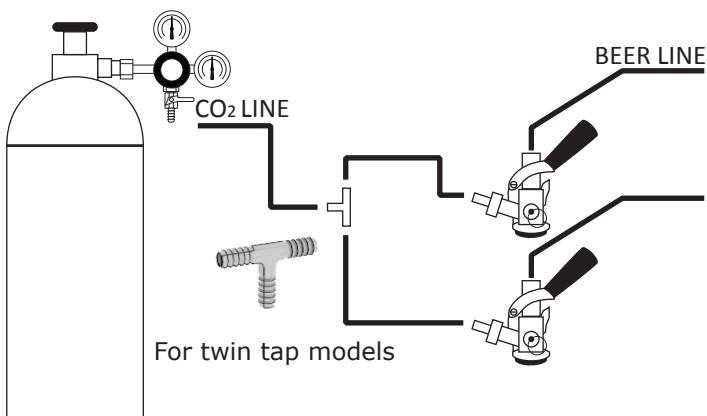

*Manifold included in triple tap models

Warning:

This guide is provided for informational purposes only. It is provided as a supplement to the owner's manual.

Please refer to the owner's manual for a full discourse on installation, usage and maintenance. If you have any questions about the installation of this appliance, feel free to contact EdgeStar service at 866.319.5473 or consult a qualified installer. Neither the manufacturer nor its distributors shall be liable for any incidental, consequential, indirect, special, or punitive damages of any nature, including without limitation, lost revenues or profits, or any other damage whether based in contract, tort, or otherwise.

Co2 cylinder comes empty due to HAZMAT restrictions. It will need to be filled locally at any air/gas supplier prior to use.