

# FIRMAN<sup>®</sup>

## OPERATOR'S MANUAL GASOLINE PORTABLE GENERATOR

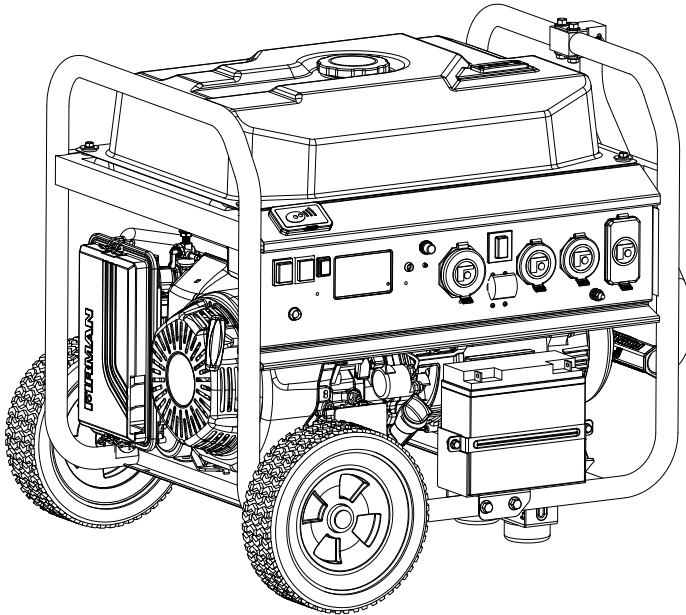

MODEL NUMBER  
**P07505**  
Rev Level:01

Record product information to reference when ordering parts or obtaining warranty coverage.

SERIAL NUMBER: \_\_\_\_\_

PURCHASE DATE: \_\_\_\_\_

**STOP** DO NOT RETURN TO STORE!

CALL US FIRST  
**1-844-347-6261**

FOR QUESTIONS OR SERVICE INFORMATION



# INTRODUCTION

---

---

## Table of Contents

Introduction .....	1
Features and Controls .....	5
Operation .....	11
Maintenance - Storage .....	22
Troubleshooting- Specifications .....	29
Parts Diagrams - Parts Lists - Wiring Diagram .....	32
Service - Warranty .....	39

### REGISTER YOUR PRODUCT

Register your product using the QR code provided or at [www.firmanpowerequipment.com](http://www.firmanpowerequipment.com).





## INTRODUCTION

Thank you for purchasing a FIRMAN generator. You have selected a high-quality, precision engineered generator set designed and tested to give you years of satisfactory service. This generator is designed to run only on unleaded gasoline. This generator is not intended to be run unattended or to supply power to life safety support.

This manual contains safety information to make you aware of the hazards and risks associated with generator products and how to avoid them. This generator is designed and intended only for supplying electrical power for operating compatible electrical lighting, appliances, tools and motor loads, and is not intended for any other purpose. It is important that you read and understand these instructions thoroughly before attempting to start or operate this portable generator. Save these original instructions for future reference.

All information in this publication is based on the latest production information available at the time of approval for printing. The manufacturer reserves the right to change, alter or otherwise improve the generator and this documentation at any time without prior notice.

## SIGNAL WORDS

 <b>DANGER</b>	 <b>WARNING</b>	 <b>CAUTION</b>	<b>NOTICE</b>
Indicates a hazard which, if not avoided, will result in death or serious injury.	Indicates a hazard which, if not avoided, could result in death or serious injury.	Indicates a hazard which, if not avoided, could result in minor or moderate injury.	Indicates information considered important, but not hazard-related.



Safety Alert Symbol- Indicates a potential personal injury hazard.



Operator's Manual- Failure to follow warnings, instructions and operator's manual could result in death or serious injury.



Toxic Fumes- Engine exhaust contains carbon monoxide, a poisonous gas that will kill you in minutes. You cannot smell it or see it.



Generator could cause electrical shock resulting in death or serious injury.



Fire- Fuel and its vapors are extremely flammable which could cause burns or fire resulting in death or serious injury. Engine exhaust could cause fire resulting in death or serious injury.



Hot Surface- Muffler could cause burns resulting in serious injury.

# INTRODUCTION



**WARNING!** This product can expose you to chemicals including gasoline engine exhaust, which is known to the State of California to cause cancer, and carbon monoxide, which is known to the State of California to cause birth defects or other reproductive harm. For more information go to [www.P65Warnings.ca.gov](http://www.P65Warnings.ca.gov).

This outdoor generator can be used to power outdoor items using extension cords or to restore home power using a transfer switch. A transfer switch is a separate device installed by a licensed electrician that allows the portable generator to be cord connected, using either of the 120/240V receptacles, directly into your home's electrical system. Install a listed transfer switch as soon as possible if this generator will be used to restore power to your home.

**NOTICE** If you have questions about intended use, contact FIRMAN customer service. This portable generator is designed to be used only with FIRMAN authorized parts.

## System Ground

The generator has a system ground that connects the generator frame components to the ground terminals on the AC output receptacles. The system ground is connected to the AC neutral wire. The neutral is bonded to the generator frame.

## Compliance Requirements

There may be Federal or State regulations, local codes, or ordinances that apply to the intended use of the generator. Consult a qualified electrician, electrical inspector, or the local agency having jurisdiction. This generator is not intended to be used at a construction site or similar activity as defined by NFPA 70-2020 (NEC) section 590.6.

## To Restore Home Power Using a Listed Transfer Switch

Connections to your home's electrical system must use a listed\* transfer switch installed by a licensed electrician. The connection must isolate the generator power from the utility power and comply with all applicable laws and electrical codes.

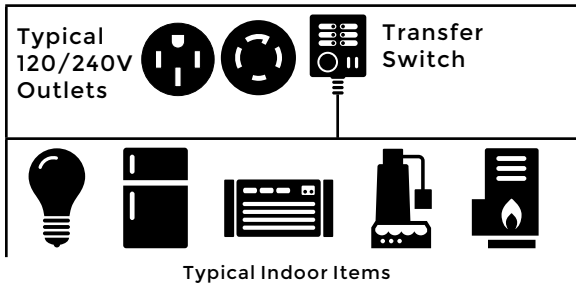

## To Restore Power Using Extension Cords

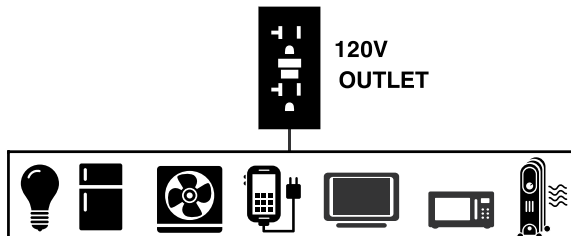

1. Only use grounded cords marked for outdoor use rated for your loads.

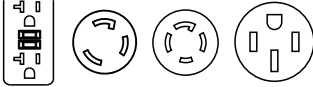
 <b>To provide power using extension cords</b>	
Total Amperage	Minimum Gauge, Outdoor Rated
	Up to 50 FT (15 m)
Up to 13A	<b>16</b>
Up to 15A	<b>14</b>
Up to 20A	<b>12</b>
Up to 30A	<b>10</b>
Up to 50A	<b>6</b>

2. Follow cord safety instructions.

3. Install carbon monoxide alarm(s).

4. When operating portable generator with extension cords, make sure portable generator is located downwind in an open, outdoor area, at least 20 ft. (6 m.) from occupied spaces with exhaust pointed away.

5. Extension cords running directly into your home, powering indoor items IS NOT RECOMMENDED.



**DANGER!** Engine exhaust contains carbon monoxide, a poisonous gas that will kill you in minutes. You cannot smell it, see it, or taste it. Even if you do not smell exhaust fumes, you could still be exposed to carbon monoxide gas.

- Extension cords running directly into the home increase your risk of carbon monoxide poisoning through any openings.
- If an extension cord running directly into your home is used to power indoor items, the operator recognizes that this increases the risk of CO poisoning to people inside the home and assumes that risk.

6. Install a listed \*transfer switch as soon as possible if this or any generator will be used to restore power to your home.

\*Certified by a Nationally Recognized Testing Laboratory that the product complies to appropriate product safety test standards.

# FEATURES AND CONTROLS

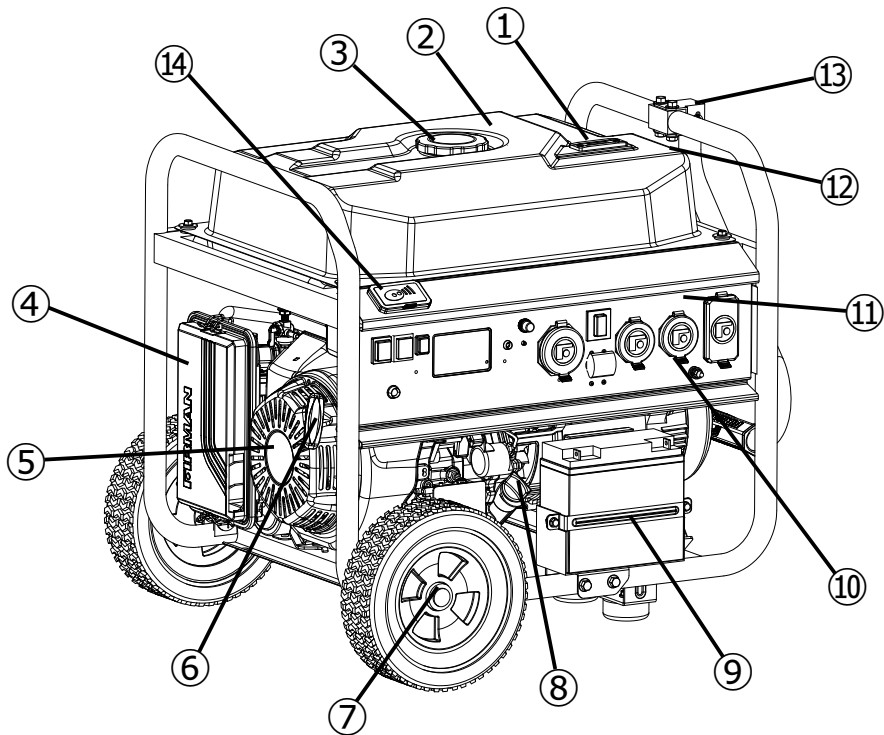

- 1- Fuel Gauge
- 2- 8.0 Gallon(30L) Capacity Fuel Tank
- 3- Fuel Cap
- 4- Air Filter
- 5- 439cc FIRMAN OHV Engine
- 6- Recoil Starter

- 7- 10.0"(25.4cm) Flat Free Wheel
- 8- Oil Filler Cap
- 9- Battery
- 10- Outlet Cover
- 11- Control Panel
- 12- Data Decal / Serial Number
- 13- Handle
- 14- Remote Holder

The remote controller can be placed inside the remote holder for easy access.

**\*We are always working to improve our products. Therefore, the enclosed product may differ slightly from the image on this page.**

# FEATURES AND CONTROLS

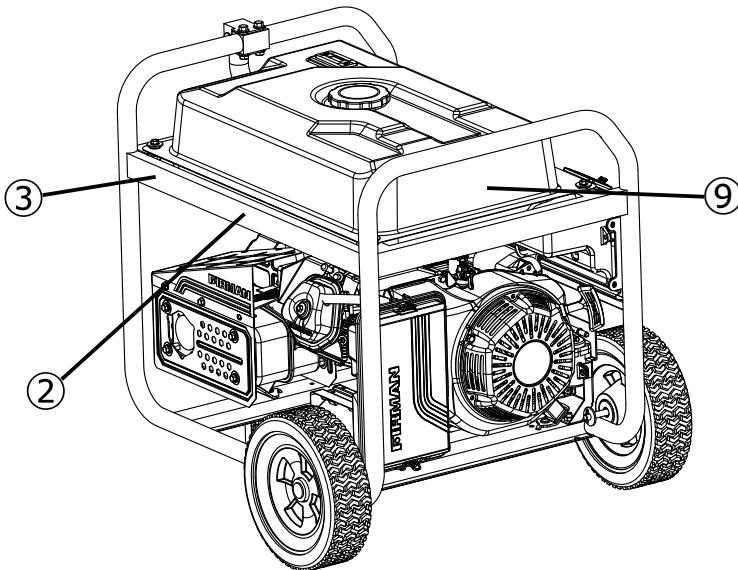
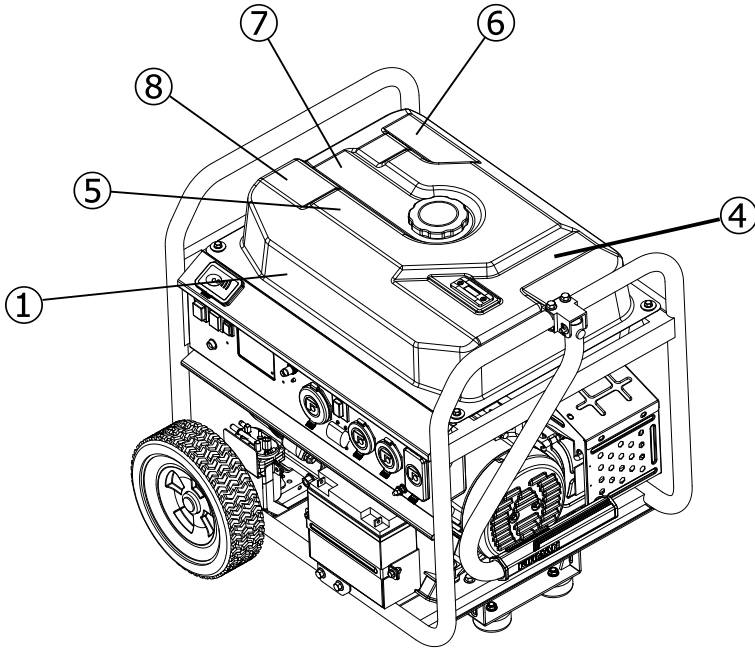

# FEATURES AND CONTROLS

①

⚠ <b>DANGER</b>		⚠ <b>PELIGRO</b>		⚠ <b>DANGER</b>	
Using a generator indoors <b>CAN KILL YOU IN MINUTES</b> . Generator exhaust contains carbon monoxide. This is a poison you cannot see or smell.		Utilizar un generador en interiores <b>PUEDA PROVOCARLA MUERTE EN CUESTIÓN DE MINUTOS</b> . Los gases del generador contienen monóxido de carbono, el cual es una sustancia venenosa que no puede verse ni olerse.		Utiliser un générateur à l'intérieur <b>PEUT VOUS TUER EN QUELQUES MINUTES</b> . Les gaz d'échappement du générateur contiennent du monoxyde de carbone. Ceci est un poison que vous ne pouvez ni voir ni sentir.	
NEVER use inside a home or garage, <b>EVEN IF</b> doors and windows are open.	Only use <b>OUTSIDE</b> and far away from windows, doors, and vents.	No utilice <b>NUNCA</b> el generador en el interior de su hogar ni en un garaje. <b>NI SIQUIERA</b> con las puertas y ventanas abiertas.	Utilice sólo <b>AL AIRE LIBRE</b> y lejos de ventanas, puertas y orificios de ventilación.	<b>NE JAMAIS</b> utiliser dans un garage ou à l'intérieur. <b>MÊME</b> avec les portes et les fenêtres ouvertes.	A n'utiliser qu'à <b>L'EXTÉRIEUR</b> et à distance de toutes fenêtres, portes et ouvertures.

②

	⚠ <b>WARNING</b>	⚠ <b>ADVERTENCIA</b>	⚠ <b>AVERTISSEMENT</b>
	Muffler could cause burns resulting in serious injury. • Do not touch hot parts • Avoid hot exhaust gases	El silenciador podría causar quemaduras que ocasionen lesiones graves. • No toque las partes calientes • Evite los gases calientes del escape	Le silencieux peut provoquer des brûlures et entraîner des blessures graves. • Ne touchez pas les pièces chaudes • Évitez les gaz d'échappement chauds

③

**Point engine exhaust away from all occupied structures.**

**Mantenga los gases de escape del motor lejos de instalaciones ocupadas.**  
**Éloignez l'échappement du moteur des structures occupées.**

④

	<b>NOTICE</b>	<b>AVISO</b>	<b>AVIS</b>
	Operate, store and transport on firm level surface. • Tilting can cause fuel spillage.	Opere, almacene y transporte en una superficie firme y nivelada. • La inclinación puede causar fugas de combustible.	Faire fonctionner, entreposer et trans porter sur une surface plane et ferme. • L'inclinaison peut provoquer des fuites de carburant.

⑤

	<b>AUTOMATIC SHUTOFF - YOU MUST:</b>		<b>CORTE AUTOMÁTICO-DEBE REALIZAR LO SIGUIENTE:</b>		<b>ARRÊT AUTOMATIQUE - VOUS DEVEZ:</b>
	MOVE GENERATOR TO AN OPEN OUTDOOR AREA, POINT EXHAUST AWAY FROM HOMES. <b>DO NOT RUN GENERATOR IN ENCLOSED AREAS</b> (e.g. NOT IN HOUSE OR GARAGE). AIR OUT PREMISES (OPEN WINDOWS AND DOORS) BEFORE REOCCUPYING PROPERTY.		MUEVA EL GENERADOR A UN ÁREA ABIERTA AL AIRE LIBRE. APUNTE EL ESCAPE LEJOS DE LAS CASAS. <b>NO UTILICE EL GENERADOR EN ÁREAS CERRADAS</b> (EN CASA O EL GARAJE). VENTILE LAS INSTALACIONES (VENTANAS Y PUERTAS ABIERTAS) ANTES DE VOLVER A OCUPAR LA PROPIEDAD.		DÉPLACEZ LA GÉNÉRATRICE DANS UN ESPACE EXTÉRIEUR OUVERT. ÉLOIGNEZ L'ÉCHAPPEMENT DES MAISONS. <b>NE FAITES PAS FONCTIONNER LA GÉNÉRATRICE DANS DES ZONES FERMÉES</b> (P. EX. PAS DANS LA MAISON NI DANS LE GARAGE). AÉREZ LES LIEUX (FENÊTRES ET PORTES OUVERTES) AVANT DE REINTÉGRER LA PROPRIÉTÉ.
	MOVE TO FRESH AIR AND GET MEDICAL HELP IF SICK, DIZZY OR WEAK.		UBÍQUESE EN UN LUGAR DONDE CORRA AIRE FRESCO Y BUSQUE AYUDA MÉDICA SI SE SIENTE MAL, MAREADO O DÉBIL.		ALLEZ À L'AIR FRAIS ET OBTENEZ DE L'AIDE MÉDICALE EN CAS DE MALADIE, D'ÉTOURDISSEMENT OU DE FAIBLESSE.



⑥



Fuel level indicator  
Indicador de nivel de combustible  
Indicateur de niveau de carburant

## ⚠️ WARNING

Fuel is flammable which could cause burns resulting in death or serious injury.

- Turn engine off and let it cool at least 2 minutes before refueling.
- Do not fill fuel above fuel level indicator.
- Never add fuel to a hot or running generator.

## ⚠️ ADVERTENCIA

El combustible es inflamable, lo que puede causar quemaduras y provocar la muerte o lesiones graves.

- Apague el motor y déjelo enfriar al menos 2 minutos antes de repostar.
- No llene el combustible por encima del indicador de nivel de combustible.
- Nunca agregue combustible a un generador caliente o en funcionamiento.

## ⚠️ AVERTISSEMENT

Le carburant est inflammable, ce qui pourrait provoquer des brûlures entraînant la mort ou des blessures graves.

- Arrêtez le moteur et laissez-le refroidir au moins 2 minutes avant de faire le plein.
- Ne remplissez pas de carburant au-dessus de l'indicateur de niveau de carburant.
- N'ajoutez jamais de carburant à un générateur chaud ou en marche.

⑦

## ⚠️ PELIGRO



El incumplimiento de las advertencias, las instrucciones y el manual del operador provocará la muerte o lesiones graves.



La alteración del sistema de alerta de CO causará envenenamiento por monóxido de carbono. Instale detectores de Monóxido de Carbono dentro de su casa.



El generador podría producir una descarga eléctrica. • No utilice en interiores para evitar condiciones de humedad. • No utilice en la lluvia o en condiciones de humedad. • Es necesario usar un interruptor de transferencia cuando se conecta al sistema eléctrico de una casa.



Los gases calientes de salida podrían causar incendios. Manténgase a una distancia mínima de 1,5 m de cualquier combustible o estructura, incluyendo lugares elevados.

## ⚠️ DANGER



Le non-respect des avertissements, des instructions et du manuel de l'opérateur entraînera la mort ou des blessures graves.



Toute altération du système D'ALERTE du monoxyde de carbone causera un empoisonnement au monoxyde de carbone. Installez des détecteurs de monoxyde de carbone à l'intérieur de la maison.



La génératrice pourrait provoquer un choc électrique. • Ne faites pas fonctionner à l'intérieur pour éviter les conditions humides. • Ne faites pas fonctionner sous la pluie ou par temps pluvieux. • Un commutateur de transfert doit être utilisé lors du raccordement au système électrique d'une maison.



Les gaz d'échappement chauds peuvent provoquer des incendies. Gardez au moins 5 pi (1,5 m) de dégagement de tout combustible ou de toute structure, y compris au-dessus.

⑧

## ⚠️ DANGER



Failure to follow warnings, instructions and operator's manual will result in death or serious injury.



Tampering with the CO ALERT system will cause Carbon Monoxide poisoning. Install Carbon Monoxide alarms inside home.



Generator could cause electrical shock.

- Do not run indoors to avoid wet conditions.
- Do not run in rain or wet weather.
- Transfer switch must be used when connecting to a home's electrical system.



Hot exhaust gases could cause fires. Keep at least 5ft. (1.5m) clearance from any combustibles or structures, including overhead.

⑨

### FOR RESIDENTS OF CALIFORNIA

⚠️ WARNING: This product and the engine exhaust from this product can expose you to chemicals including CO, which are known to the State of California to cause cancer or cause birth defects and other reproductive harm. For more information, go to [www.P65Warnings.ca.gov](http://www.P65Warnings.ca.gov).

### PARA LOS RESIDENTES DE CALIFORNIA

⚠️ ADVERTENCIA: Este producto y el escape del motor de este producto pueden exponerlo a productos químicos, incluido CO, que en el estado de California son conocidos por causar cáncer o causar defectos de nacimiento u otros daños reproductivos. Para obtener más información, vaya a [www.P65Warnings.ca.gov](http://www.P65Warnings.ca.gov).

### POUR LES RÉSIDENTS DE LA CALIFORNIE

⚠️ AVERTISSEMENT: Ce produit et l'échappement du moteur de ce produit peuvent vous exposer à des produits chimiques, y compris le CO, qui sont connus par l'Etat de Californie pour causer le cancer ou causer des malformations congénitales et autres problèmes de reproduction. Pour plus d'informations, visitez [www.P65Warnings.ca.gov](http://www.P65Warnings.ca.gov).

# FEATURES AND CONTROLS

## Control Panel

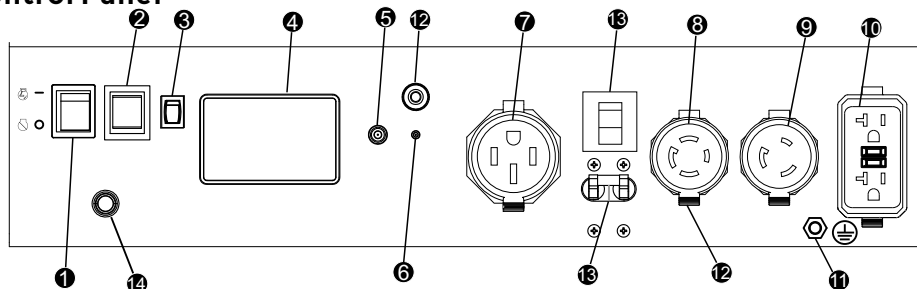

**NOTICE** Total power drawn from all receptacles must not exceed the data decal rating.

1. **Engine Start Switch 1** - Flip switch 1 to the RUN (I) position. The fuel pump will operate for about 8 seconds injecting fuel into the combustion chamber.

2. **Engine Start Switch 2** - To start engine, press and hold the switch, the engine will crank and attempt to start. When the engine starts, release the switch.

3. **Idle Switch** - Activating the idle switch allows for reduced engine speed during times of no electrical output minimizing fuel consumption and reducing noise. The engine speed returns to normal when an electrical load is connected.

**NOTICE** Before using any high-power device (about 4500W or greater) turn idle switch "OFF" (O).

4. **Intelligauge with LCD Screen** - The screen can show the Voltage, Hertz, Power, running hours, Fault alarm, regular maintenance and low oil alarm.

5. **Remote Start Indicator Light** - The light will light or flash depending on the status of the remote start system.

6. **Remote Start Program Button** - Use this button along with the remote control to program the generator to be started remotely. Your remote control is already programmed at the factory for your convenience. If remote start control is ever replaced you may need to program. Contact FIRMAN customer service.

7. **120/240V, 50A** - (NEMA 14-50R) (Not GFCI protected)

A maximum of 31.3 Amps current for 240 Volts or two independent 120 Volt loads at 31.3 Amps current each.

8. **120/240V, 30A Twist Lock** - (NEMA L14-30R) (Not GFCI protected)

A maximum of 30 Amps current for 240 Volts or two independent 120 Volt loads at 30 Amps current each.

9. **120V, 30A Twist Lock** - NEMA L5-30R (Not GFCI protected)

A maximum of 30 Amps current may be drawn from this receptacle.

10. **120V, 20A Duplex GFCI** (Ground Fault Circuit Interrupter)- NEMA 5-20R

A maximum of 20 Amps current may be drawn from this duplex receptacle.

11. **Ground Terminal** - Consult an electrician or authority having jurisdiction for local grounding requirements.

12. **Outlet Cover** - Protects the receptacles from dust and debris.

13. **Circuit Breakers** - The receptacles are protected by AC circuit protectors. If the generator is overloaded or an external short circuit occurs, a circuit protector may trip. If tripping occurs, disconnect all electrical loads and determine the cause before attempting to continue using the generator. Reset any tripped circuit protectors.

If multiple receptacles are used at the same time, the total current must be kept within the portable generator data decal rating.

14. **CO Alert™ Carbon Monoxide (CO) Shutdown Indicator Light** - Indicates the engine shutdown due to carbon monoxide accumulation around the generator or a CO Alert system fault occurred.

## Intelligauge Display Screen



A. Remaining fuel

B. Electric load

 CO Alert alarm

 Low oil level

 Display value

 Fuel pump fault

 Generator maintenance required

 Low battery voltage

 ECO mode (no load, low idle speed)

 Power output overload

 EFI system ECU fault

 Electrical output is ready

 Voltage

 Frequency

 Power

 Total run time

 Remaining run time

# OPERATION

## 1. Location



**DANGER!** Engine exhaust contains carbon monoxide, a poisonous gas that could kill you in minutes. You **CANNOT** smell it, see it, or taste it. Even if you do not smell exhaust fumes, you could still be exposed to carbon monoxide gas.

- Operate portable generator only outdoors and downwind at least 20 ft. from occupied spaces with exhaust pointed away to reduce the risk of carbon monoxide accumulating.
- Install battery-operated carbon monoxide alarms or plug-in carbon monoxide alarms with battery back-up according to the manufacturer's instructions. Smoke alarms cannot detect carbon monoxide gas.
- Do not run this portable generator inside homes, garages, basements, crawlspaces, sheds, or other partially-enclosed spaces even if using fans or opening doors and windows for ventilation. Carbon monoxide can quickly build up in these spaces and can linger for hours, even after this product has shut off.
- If you start to feel sick, dizzy, weak or your home's carbon monoxide alarm sounds, get to fresh air right away. Call emergency services. You may have carbon monoxide poisoning.

### Carbon Monoxide Alarm(s)

Install carbon monoxide alarms inside your home. Without working carbon monoxide alarms, you will not realize you are getting sick and dying from carbon monoxide poisoning.

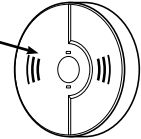

### Prevent Carbon Monoxide (CO) Poisoning

Use outdoors and downwind at least 20 ft. (6.0 m) from any home. Point exhaust away from all homes and occupied spaces. Install CO alarms inside your home.

20 ft. (6 m) min.

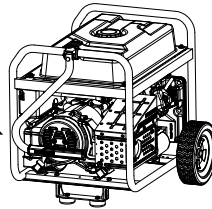

**To better educate yourself about all carbon monoxide risks, go to [www.takeyourgeneratoroutside.com](http://www.takeyourgeneratoroutside.com).**

## Reduce Risk of Fire



**WARNING!** Exhaust heat/gases could ignite combustibles, structures or damage fuel tank causing a fire, resulting in death or serious injury.

- Keep portable generator at least 5 ft. (1.5 m) from any structure, trees or vegetation over 12 in. (30 cm) in height.
- Select an outdoor site that is dry and protected from the weather. Do not move portable generator indoors to protect it from the weather. Do not locate the portable generator under a deck or other similar structure that may confine heat and airflow.

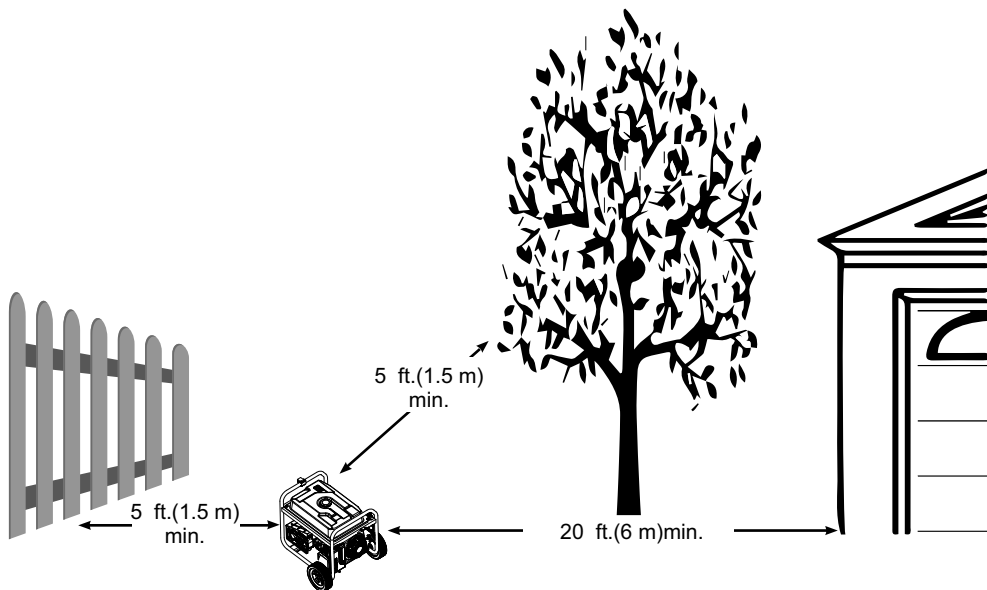

# OPERATION

## 2. Oil and Gasoline

### Add Engine Oil

We recommend using SAE 10W-30 API SL or higher oil for best performance. Do not use special additives. Ambient temperature determines the proper oil viscosity for the engine. Use the chart to select the proper oil for the outdoor temperature range expected.

**NOTICE** Do not attempt to crank or start the engine before it has been properly filled with the recommended type and amount of oil. Damage due to operation with no oil will void your warranty.

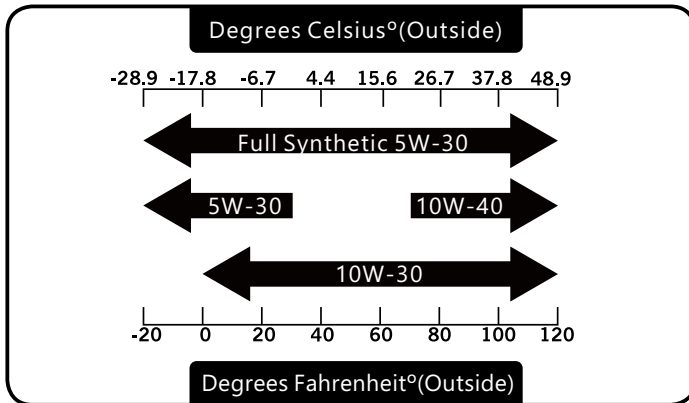

1. Place generator on a flat, level surface.
2. Clean area around oil fill and remove yellow oil fill cap/dipstick.
3. Wipe dipstick clean.

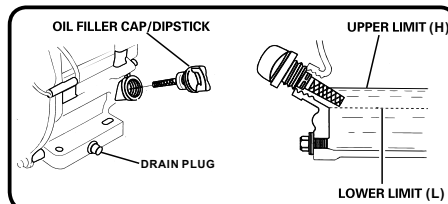
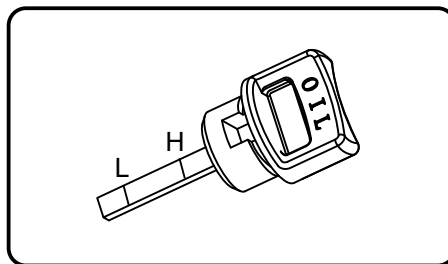

4. Using oil funnel, slowly pour contents of provided oil bottle into oil fill opening until oil reaches upper limit "H" mark on the dipstick. Be careful not to overfill. Overfilling could cause engine starting problems or engine damage.

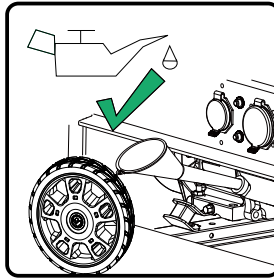

5. Replace oil fill cap/dipstick and fully tighten.

6. Oil level should be checked prior to each use or at least every 8 hours of operation. Keep oil level maintained.

## Low Oil Shutdown

The portable generator is equipped with a low oil shutdown. If the oil level drops below the minimum required level, a sensor will activate an internal switch stopping the engine. If the engine shuts off and the oil level is within specifications, check to see if generator is sitting at an angle. Place portable generator on an even surface to correct this. If engine fails to start, the oil level may not be high enough to deactivate the internal low oil level switch. Make sure the sump is completely full of oil to the upper limit (H). Do not operate engine until oil level issue is corrected. Contact FIRMAN customer service.

## Add Gasoline



**WARNING!** Fuel and its vapors are extremely flammable which could cause burns or fire resulting in death or serious injury.

- Turn generator engine OFF and let it cool at least 2 minutes before removing fuel cap.
- Do Not refuel or move generator when engine is running.
- Move generator outdoors prior to adding or draining fuel
- Keep fuel away from any ignition sources.
- Do not overfill tank, allow space for fuel expansion.
- If any fuel spills, wait until it evaporates before starting engine
- Check and replace fuel lines, tank, cap, and fittings prior to each use if any damage or leaks are found.

Fuel must meet these requirements:

- Clean, fresh, unleaded gasoline with a minimum of 87 octane.
- For high altitude use, see Operation at High Altitude.
- Gasoline with no more than 10% ethanol is acceptable.

E10

E15

# OPERATION

---

**NOTICE** Do not mix oil in gasoline or modify engine to run on alternate fuels not described in this manual. Use of unapproved fuels could damage engine and will not be covered under warranty.

1. Clean area around fuel fill cap, remove cap.
2. Slowly add unleaded fuel to fuel tank. Be careful not to fill above the RED fuel level indicator. This allows adequate space for fuel expansion.

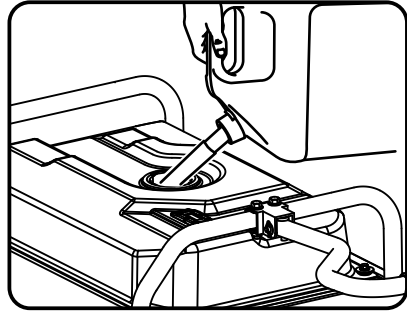
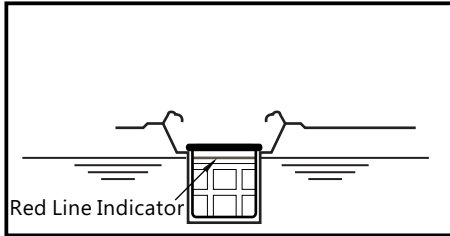

3. Install fuel cap and let any spilled fuel evaporate before starting engine.

## Operation at High Ambient conditions

Your FIRMAN Power Equipment product is designed and rated for continuous operation at ambient temperatures up to 104°F (40°C). The generator may be operated at temperatures ranging from 5°F (-15°C) to 122°F (50°C) for short periods. If the generator is exposed to temperatures outside this range during storage, the generator should be brought back within this range before operation. When operated above 77°F (25°C) there may be a decrease in power. Maximum wattage and current are subject to and limited by such factors as ambient temperature, altitude, engine conditions etc.



### 3.Starting the Generator

1. Before starting the generator, check for loose or missing parts and for any damage which may have occurred during shipment. Ensure spark plugs, muffler, fuel cap, and air cleaner are all in place.
2. Move portable generator outdoors to safe operating location downwind and at least 20 feet from any occupied spaces.
3. Disconnect all electrical loads from the generator. Never start or stop the generator with electrical devices plugged in.

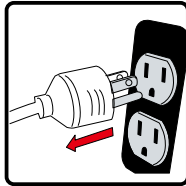

4. Turn the fuel valve to the "ON" (I) position.

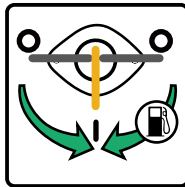

5. Flip switch 1 to the RUN (I) position. The fuel pump will operate for about 8 seconds injecting fuel into the combustion chamber. Wait about 8 seconds before moving to next step.



6. For recoil start only-Pull the starter cord slowly until resistance is felt and then pull rapidly.

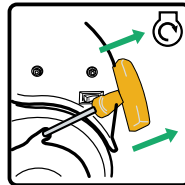

7. For electric start only-Flip the engine switch 2 for a few seconds and then release.

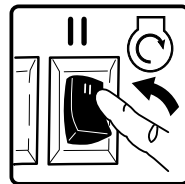

# OPERATION

---

8. For remote start only - Push and release the "START" button on the remote control. The generator will turn over for 3 to 5 seconds and start.

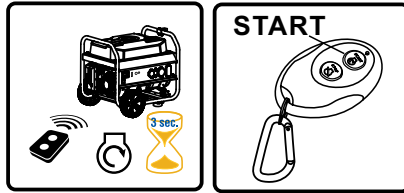

An engine warmup delay is programmed into the remote start cycle. After the generator is running, there will be a delay of electrical output for 15 seconds.

If the engine fails to start within 3 to 5 seconds, the engine will attempt to start five additional times. If the generator failed to start, the remote start indicator light will flash.

If the generator fails to start after a total of six attempts, the start button on the remote control must be pushed again to begin another cycle of six start attempts.

9. Allow portable generator to run at no load for a few minutes to stabilize before plugging in any electrical devices.

**NOTICE** If engine starts but fails to run, or if portable generator shuts down during operation, check oil level. See Low Oil Shutdown section for more information.

If the engine fails to start, flip the engine switch 1 to the "OFF(O)" position, and then flip the engine switch 1 to the "RUN(I)" position again.

## 4. Connecting Electrical Loads

This portable generator has been pretested and adjusted to handle its full capacity. The voltage is regulated using an automatic voltage regulator (AVR). Readjusting the AVR will void warranty.

The duplex receptacle is equipped with GFCI protection. The GFCI protects against electric shock that may be caused if you become a path which electricity travels to reach earth. Even with a GFCI you may feel a shock, but the GFCI cuts power quickly so an average person should not suffer any injury. Manual test GFCI while generator is running to verify internal contacts will function

- Push the test button. The reset button will pop out, which should cut power to outlet.
- Press the reset button until it locks in the depressed position. If the GFCI does not reset as described do not use the receptacles. Call FIRMAN customer service.
- If GFCI trips while in use, reset and test the outlet. Electric cords laying on the ground with worn insulation may trip the GFCI, only use cords in good condition.

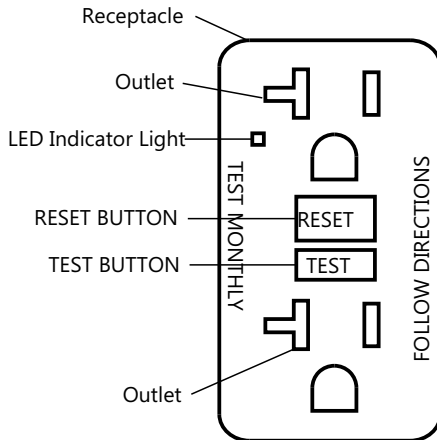

## SELF-TEST OPERATION

In addition to the manual test / reset feature the GFCI receptacle tests itself periodically to confirm the GFCI electronics are functional. The indicator light will be solid green when the GFCI is powered from the generator and working correctly.

**Self-test indications:** If the indicator light is solid orange or flashing red a problem may exist. Press the TEST button to trip the GFCI. If unable to reset, replace the GFCI.



**WARNING!** Generator voltage could cause electrical shock or burn resulting in death or serious injury.

- Damaged or overloaded extension cords could overheat, arc, and burn resulting death or serious injury.
- Use a ground fault circuit interrupter (GFCI) in any damp or highly conductive area, such as metal decking.
- Do not touch bare wires or receptacles.

# OPERATION

---

- Do not use generator with electrical cords which are worn, frayed, bare or otherwise damaged.
- Do not operate generator in the rain or wet weather.
- Do not run indoors to avoid wet conditions.
- Do not handle generator or electrical cords while standing in water, while barefoot, or while hands or feet are wet.
- Use listed transfer switch to prevent backfeed by isolating generator from electric utility workers.

1. Ensure circuit breaker on control panel is in the closed (on) position.
2. Start the generator with no electrical load attached.
3. Allow the engine to run for several minutes to stabilize.
4. Plug in and turn on the first item. It is best to attach the item with the largest load first.
5. Allow the engine to stabilize.
6. Plug in and turn on the next item.
7. Allow the engine to stabilize.
8. Repeat steps 5-6 for each additional item.

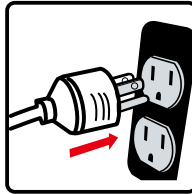

## Surge Protection

There is a remote chance that voltage fluctuations may impair the proper functioning of some sensitive electronic equipment. Electronic devices, including computers and many programmable appliances may use components that are designed to operate within a narrow voltage range and may be affected by the portable generator's momentary voltage fluctuations. While there is no way to prevent all voltage fluctuations, you can take steps to protect your sensitive electronic equipment. Install a plug-in surge suppressor on the receptacles feeding your sensitive equipment. Surge suppressors come in single or multi-outlet styles. They are designed to protect against short duration voltage fluctuations.

## CO Alert™

### Carbon Monoxide (CO) Shutdown System

CO Alert automatically shuts down the engine when harmful levels of carbon monoxide accumulate around the generator or a CO Alert fault occurs. After shutdown, the CO Alert indicator light will blink for at least five minutes per the chart below.

CO Alert DOES NOT replace carbon monoxide alarms.

Install battery-powered carbon monoxide alarm(s) in your home. Don't run generator in enclosed areas.

Color	Description
<p><b>Red</b> •••••</p>	<p>Carbon monoxide accumulated around generator. Prior to restart move generator to an open, outdoor area downwind and at least 20 ft. (6 m) from occupied spaces with exhaust pointed away. Air out premises (open windows and doors) before reoccupying property. Automatic shutoff is an indication generator was improperly located.</p> <p>If you start to feel sick, dizzy, weak, or your homes carbon monoxide alarm sounds while using this product, get to fresh air right away. Call emergency services. You may have carbon monoxide poisoning.</p>
<p><b>Yellow</b> •• ••</p>	<p>CO Alert fault occurred*. See FIRMAN authorized service dealer.</p>

\*Yellow light will blink for five seconds at the startup of generator to show CO ALERT is functioning properly.

## 5. Stopping the generator

1. Turn off and remove all electrical loads.

Never stop the generator with electrical devices plugged in and turned on.

Never stop the engine by moving the choke to the start position.

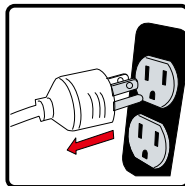

Let the generator run at no-load for one minute to stabilize internal temperatures of the engine and generator.

# OPERATION

---

2. For remote stop only - Push and release the "STOP" button on the remote control. The generator will run for an additional 15 seconds as it goes through a cool down cycle before shutting off.

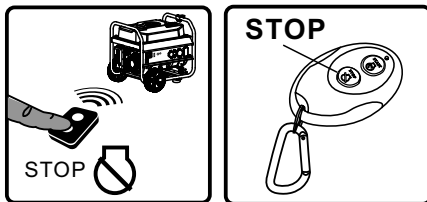

3. Flip the engine switch 1 to "OFF"(O) position.



4. Turn the fuel valve to the "OFF"(O) position.

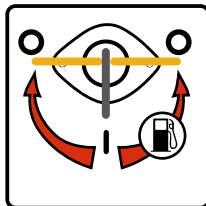

If a cover is used, do not install until unit has cooled.

## MAINTENANCE SCHEDULE

ITEM	NOTES	Daily(Before operation)	Initial 25 hours	Every 50 hours	Every 100 hours (or annual)	Every 250 hours
Spark Plug	Check condition. Adjust gap and clean. Replace if necessary.				✓	
Engine Oil	Check oil level.	✓				
	Replace.		✓		✓	
Air Filter	Clean, replace if necessary.			✓		
Fuel	Clean fuel tank strainer. Replace if necessary.				✓	
Fuel Line	Check fuel hose for cracks or other damage. Replace if necessary.	✓				
Exhaust System	Check for leakage. Retighten or replace gasket if necessary.	✓				
	Check spark arrester screen. Clean/Replace if necessary.				✓	
Engine	Check adjust valve clearance.*					✓
	Clean combustion chamber.*					✓
Fittings/ Fasteners	Check. Replace if necessary.				✓	
Fuel Pump	Check. Replace if necessary.					✓

\* To be performed by knowledgeable/experienced owner or by authorized service center.

### General Recommendations

Regular maintenance will improve the performance and extend the life of the generator. See any authorized dealer for service.

The generator's warranty does not cover items that have been subjected to operator abuse or negligence. To receive full value from the warranty, the operator must maintain the generator as instructed in this manual.

Some adjustments will need to be made periodically to properly maintain your generator.

All service and adjustments should be made at least once each season. Follow the requirements in the maintenance schedule chart above.

**NOTICE** Once a year you should clean or replace the spark plug and replace the air filter. New spark plug and clean air filter assure proper fuel-air mixture and help your engine run at peak performance and last longer.

# Maintenance - Storage

## When Transporting Generator

Transport with fuel tank EMPTY or with fuel valve in OFF position.  
Do not tip generator at an angle which causes fuel to spill.

## ENGINE MAINTENANCE

To prevent accidental starting, remove and ground spark plug wire before performing any service.

### Change Engine Oil

Change engine oil every 100 hours. (for a new engine, change oil after 25 hours.)

If you are using your generator under extremely dirty or dusty conditions, or in extremely hot weather change the oil more often.

**CAUTION!** Avoid prolonged or repeated skin contact with used motor oil. Used motor oil has been shown to cause skin cancer in certain laboratory animals. Thoroughly wash exposed areas with soap and water.



KEEP OUT OF REACH OF CHILDREN. DON'T POLLUTE. CONSERVE RESOURCES. RETURN USED OIL TO COLLECTION CENTERS.

(a) On a level surface drain oil into a suitable container by removing the drain plug and the oil filler cap while the engine is warm.

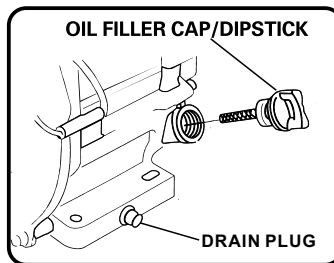

(b) Reinstall the drain plug and fill the engine with oil until it reaches the HIGH(H) level on the oil filler dipstick.

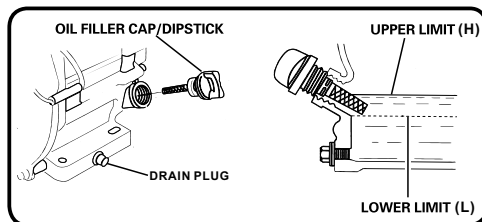
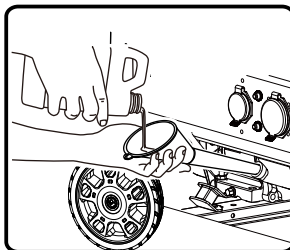

**NOTICE** We recommend using SAE 10W-30 API SL or higher oil for best performance. Do not use special additives. See **Oil and Gasoline**.



## Air Filter Maintenance

(a) Carefully remove foam air filter element and wash it with liquid detergent and water only. Squeeze dry in a clean cloth.

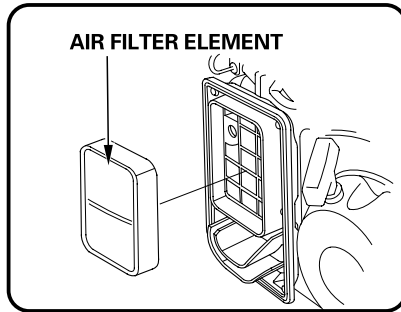
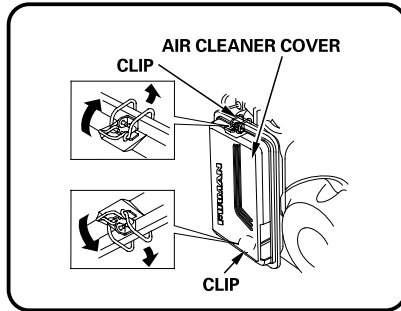

(b) Saturate foam air filter element with clean engine oil and squeeze in a clean cloth to remove excess oil.

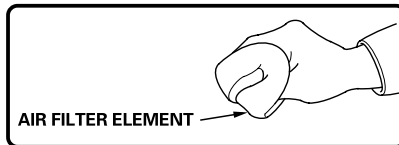

(c) Reinstall clean or new air filter element.

## Spark Plug Maintenance

Changing the spark plug will help your engine start easier and run at peak performance.

(a) Remove the spark plug boot.

(b) Remove spark plug using provided wrench.

## Maintenance - Storage

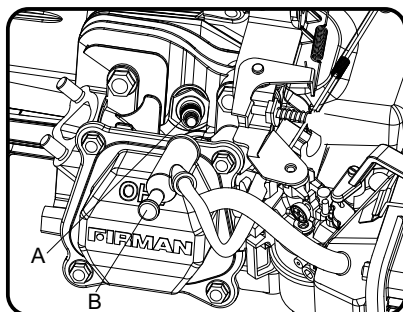

A- Spark plug  
B- Spark plug boot

(c) Inspect spark plug for damage and clean with a wire brush before reinstalling. Replace if damaged.

(d) Adjust the electrode gap to 0.028 - 0.031 in. (0.7 - 0.8 mm).

(e) Seat spark plug in position and thread by hand to prevent cross threading.

(f) Tighten plug with provided wrench and put the spark plug boot back on spark plug.

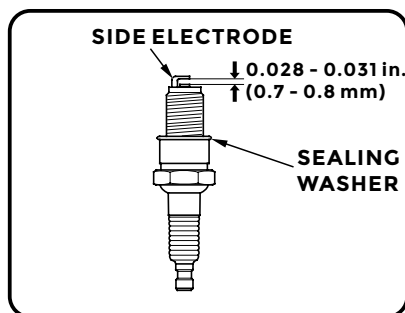

SPARK PLUG: TORCH F6RTC, NGK BPR6ES, CHAMPION RN9YC or equivalent.

## Maintenance Valve Clearance

Intake: 0.004 - 0.008 in. (0.10 - 0.20 mm)

Exhaust: 0.004 - 0.008 in. (0.10 - 0.20 mm)

## Muffler and Spark Arrester



**WARNING!** Contact with muffler area could cause burns resulting in serious injury.

- Do not touch hot parts.
- It is a violation of California Public Resource Code, Section 4442, to use or operate the engine on any forest-covered, brush-covered, or grass-covered land unless the exhaust system is equipped with a spark arrester, as defined in Section 4442, maintained in effective working order. Other states or federal jurisdictions may have similar laws, reference Federal Regulation 36 CFR Part 261.52.

## Inspect Muffler and Spark Arrester

1. Inspect the muffler for cracks, corrosion, or other damage.
2. Remove the screws securing the spark arrester in place and then remove it from the muffler.

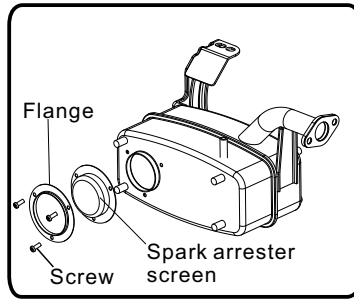

3. Carefully remove the carbon deposits from the spark arrester screen with a wire brush.

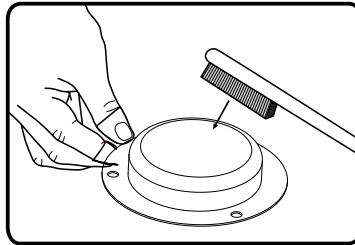

4. Replace the spark arrester if it is damaged. If replacement parts are required, make sure to use only FIRMAN original equipment replacement parts.
  5. Position the spark arrester on the muffler and attach with the screws.
- NOTICE** Failure to clean or replace spark arrester may result in decreased engine performance.

# Maintenance - Storage

## GENERATOR MAINTENANCE

Run the generator at least 30 minutes every month.

Make certain that the portable generator is kept clean and dry.

Do not expose the unit to excessive dust, dirt, moisture or corrosive vapors.

Do not insert any objects through cooling slots.

Before each use inspect underneath the generator for signs of oil or fuel. Clean any accumulated debris. Keep area around muffler free from any debris. Use a soft bristle brush to remove dirt or caked on oil. Use a damp cloth to clean all exterior surfaces.

## Battery Replacement

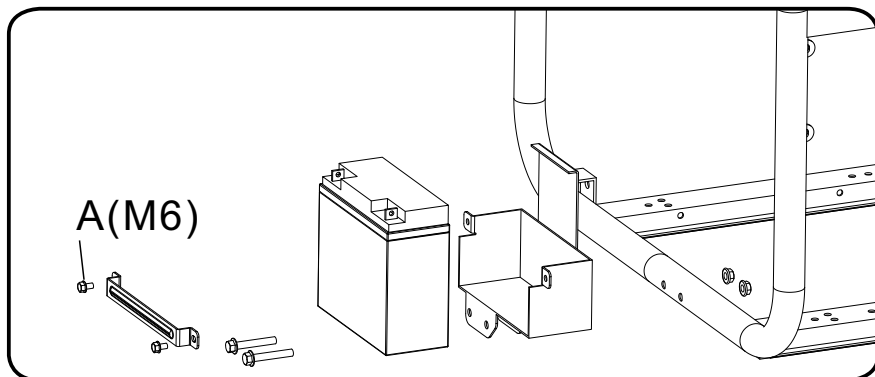

1. Remove the spark plug boot from spark plug.
2. Remove the nut and bolt from the negative(-) post first, then the positive(+) post.
3. Loosen and remove the fasteners(A) on the battery holding bracket.
4. Remove the battery and recycle.
5. Install the new battery with the following specification:  
12V sealed lead acid 15AH  
LXWXH:7.09X2.95X6.5inch(180X75X165mm)
6. Connect the red positive (+) battery cable to the battery first.
7. Connect the black negative (-) battery cable to the battery second.
8. Cover the posts with boots provided.
9. Install the spark plug boot onto spark plug.

## Battery Charging

The battery powers the starter motor and control module. This portable generator is equipped with an automatic battery charging circuit. The battery will receive charging voltage only when the engine is running. The battery will maintain a proper charge if the portable generator is used on a regular basis (about once every two weeks). If it is used less frequently, the battery should be connected to a trickle charger (not included) or battery maintainer (not included) to keep the battery properly charged. If the battery is not able to start the engine, the battery must be connected to a standard automotive style battery charger for re-charging before it can be used.

## Long Term Storage

It is important to prevent gum deposits from forming in essential fuel system components such as the throttle assembly, fuel hoses or tank during storage. Ethanol-blended fuels (called gasohol, ethanol or methanol) attract moisture, which leads to separation and formation of acids during storage. Acidic gas can damage the fuel system of an engine while in storage.

When the generator set is being stored for more than one month, follow these instructions to avoid engine problems:



**WARNING!** Fuel and its vapors are extremely flammable which could cause burns or fire resulting in death or serious injury.

Do not store fuel near any ignition sources.

When draining fuel move generator outdoors and use a commercially available non-conductive vacuum siphon. Fuel must be drained into an approved container.

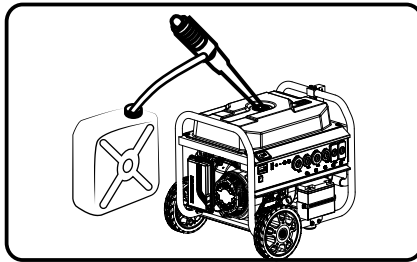

1-Treat any stored fuel with fuel stabilizer.

2-When storing generator with gasoline in fuel tank, operate the engine for 5-10 minutes to circulate treated fuel into fuel lines before shutdown.

3- There is no need to drain gasoline from the generator fuel tank if fuel stabilizer is added.

4-FUEL STARVATION: If you elect to drain fuel tank move generator outdoors. Once fuel tank is drained turn fuel valve to on position. Start and run the portable generator outdoors until engine stops from lack of gasoline. This will drain remaining gasoline from tank, fuel lines, and throttle assembly.

5-Always turn fuel valve to OFF position prior to storage.

6-Allow the portable generator to cool before cleaning and storage.

7-Change oil .

8-Remove spark plug boot and spark plug. Pour about one teaspoon(5 ml) of engine oil through the spark plug hole, then slowly pull the recoil starter several times to distribute the oil in the cylinder Pull recoil slowly until resistance is felt. This will close the valves so no moisture enters the engine cylinder.Reinstall the spark plug and attach the spark plug boot.

9-Cover the portable generator and store in a clean, dry place out of direct sunlight and away from any ignition sources.

Any damage or hazards caused by using improper fuel, improperly stored fuel, and/or improperly formulated stabilizers, are not covered by manufacturer's warranty.

Do not store gasoline from one season to another season.

# Troubleshooting - Specifications





Problem	Cause	Correction
<b>Engine is running, but no AC output is available.</b>	<ol style="list-style-type: none"> <li>1. Circuit breaker is open.</li> <li>2. Fault in generator.</li> <li>3. Poor connection or defective cord set.</li> <li>4. Connected device is bad.</li> </ol>	<ol style="list-style-type: none"> <li>1. Reset circuit breaker.</li> <li>2. Contact authorized service facility.</li> <li>3. Check and repair.</li> <li>4. Connect another device that is in good condition.</li> </ol>
<b>Engine runs good at no-load but "bogs down" when loads are connected.</b>	<ol style="list-style-type: none"> <li>1. Short circuit in a connected load.</li> <li>2. Engine speed is too slow.</li> <li>3. Shorted generator circuit.</li> <li>4. Clogged or dirty fuel filter.</li> </ol>	<ol style="list-style-type: none"> <li>1. Disconnect shorted electrical load.</li> <li>2. Contact authorized service facility.</li> <li>3. Contact authorized service facility.</li> <li>4. Clean or replace fuel filter.</li> </ol>
<b>Engine will not start; starts and runs rough or shuts down when running.</b>	<ol style="list-style-type: none"> <li>1. Fuel valve set to OFF (O) position.</li> <li>2. The indicator light is OFF or flashing red.</li> <li>3. Low oil level.</li> <li>4. Dirty air cleaner.</li> <li>5. Out of gasoline.</li> <li>6. Stale gasoline.</li> <li>7. Spark plug wire not connected to spark plug.</li> <li>8. Bad spark plug.</li> <li>9. Water in gasoline.</li> <li>10. Flooded.</li> <li>11. Excessively rich fuel mixture.</li> <li>12. Clogged or dirty fuel filter.</li> <li>13. Starting battery may have insufficient charge.</li> <li>14. Out of battery power.</li> </ol>	<ol style="list-style-type: none"> <li>1. Turn the fuel valve to the "ON" (I) position.</li> <li>2. Must have solid red indicator light to be able to start the engine.</li> <li>3. Fill crankcase to proper level or place generator on level surface.</li> <li>4. Clean or replace air cleaner.</li> <li>5. Fill fuel tank with gasoline.</li> <li>6. Drain fuel tank and throttle assembly; fill with fresh gasoline.</li> <li>7. Connect wire to spark plug.</li> <li>8. Replace spark plug.</li> <li>9. Drain gas tank and throttle assembly ; fill with fresh gasoline.</li> <li>10. Wait 5 minutes and re-crank engine.</li> <li>11. Contact authorized service facility.</li> <li>12. Clean or replace fuel filter.</li> <li>13. Check battery output and charge battery as necessary.</li> <li>14. Manually start engine.</li> </ol>
<b>Engine lacks power.</b>	<ol style="list-style-type: none"> <li>1. Load is too high.</li> <li>2. Dirty air filter.</li> <li>3. Clogged or dirty fuel filter.</li> <li>4. Clogged spark arrester.</li> <li>5. Overload in idle mode.</li> </ol>	<ol style="list-style-type: none"> <li>1. Don't Overload Generator</li> <li>2. Replace air filter.</li> <li>3. Clean or replace fuel filter.</li> <li>4. Clean or replace spark arrester.</li> <li>5. Turn off idle mode.</li> </ol>
<b>Engine "hunts" or falters.</b>	<ol style="list-style-type: none"> <li>1. Clogged or dirty fuel filter.</li> </ol>	<ol style="list-style-type: none"> <li>1. Clean or replace fuel filter.</li> </ol>
<b>Engine shuts down when running.</b>	<ol style="list-style-type: none"> <li>1. Out of gasoline.</li> <li>2. Dirty air cleaner.</li> <li>3. Low oil level.</li> </ol>	<ol style="list-style-type: none"> <li>1. Fill fuel tank with gasoline.</li> <li>2. Clean or replace air cleaner.</li> <li>3. Fill crankcase to proper level or place generator on level surface.</li> </ol>
<b>Engine shuts down and yellow CO fault light blinking.</b>	<ol style="list-style-type: none"> <li>1. CO system fault</li> </ol>	<ol style="list-style-type: none"> <li>1. Contact authorized FIRMAN service facility.</li> </ol>

For all other issues, contact authorized dealer or FIRMAN customer service.

# Troubleshooting - Specifications

## EFI FAULT INDICATOR CODES

If a problem arises with the EFI system, a fault indicator code will flash on the Intelligauge. To resolve the issue, turn off the generator, disconnect the battery negative (-) post, and follow the directions as indicated in the table below. Once the issue is resolved, reconnect the battery, and restart the generator.

Fault Code	Failure Description	Diagnosis
	Low Oil.	1. Add oil to correct level. 2. Install new oil sensor.
	Fuel pump open circuit, over current, or short to ground. Fuel pump temperature is high.	1. Check fuel pump harness is securely connected. 2. Change fuel pump. Contact authorized service facility.
	The load exceeds the rated load.	Check the load and make sure the load is less than the rated load.
	ECU SPI failure ECU crystal oscillator failure	Contact authorized service facility.

# Troubleshooting - Specifications

## SPECIFICATIONS

<b>Model</b>	<b>P07505</b>
Starting Watts	9400
Running Watts*	7500
Rated AC Voltage	120/240V
Rated Frequency	60Hz
Phase	Single
Voltage Regulator	AVR
Power Factor	1
Alternator Type	Brushed
Engine	FIRMAN
Engine Type	Single Cylinder, 4-Stroke OHV Air Cooled
Displacement	439cc
Low Oil Shutdown	Yes
Ignition System	Free Armature Injection
Starting System	Recoil/Electric Start/Remote
Fuel	Unleaded Automotive Gasoline
Capacity Fuel Tank	8 U.S. Gallons (30L)
Lubricating Oil Capacity	37.2 oz (1.1L)
Air Cleaner	Polyurethane Type
P.T.O. Shaft Rotation	Counter Clockwise (Facing P.T.O.)
Oil Type	See "Add Engine Oil" Section
AC Grounding System	Neutral Bonded To Frame

\*Generator certified in accordance with CSA (Canadian Standards Association) standard C22.2 No. 100-14, Motors and Generators and complies with PGMA (Portable Generator Manufacturers' Association) standard ANSI/PGMA G300-2018, Safety and Performance of Portable Generators and with ANSI/UL 2201 Ed. 2, Standard for Carbon Monoxide (CO) Emission Rate of Portable Generators



# PARTS DIAGRAM AND PART LIST

## P07505 PARTS DIAGRAM

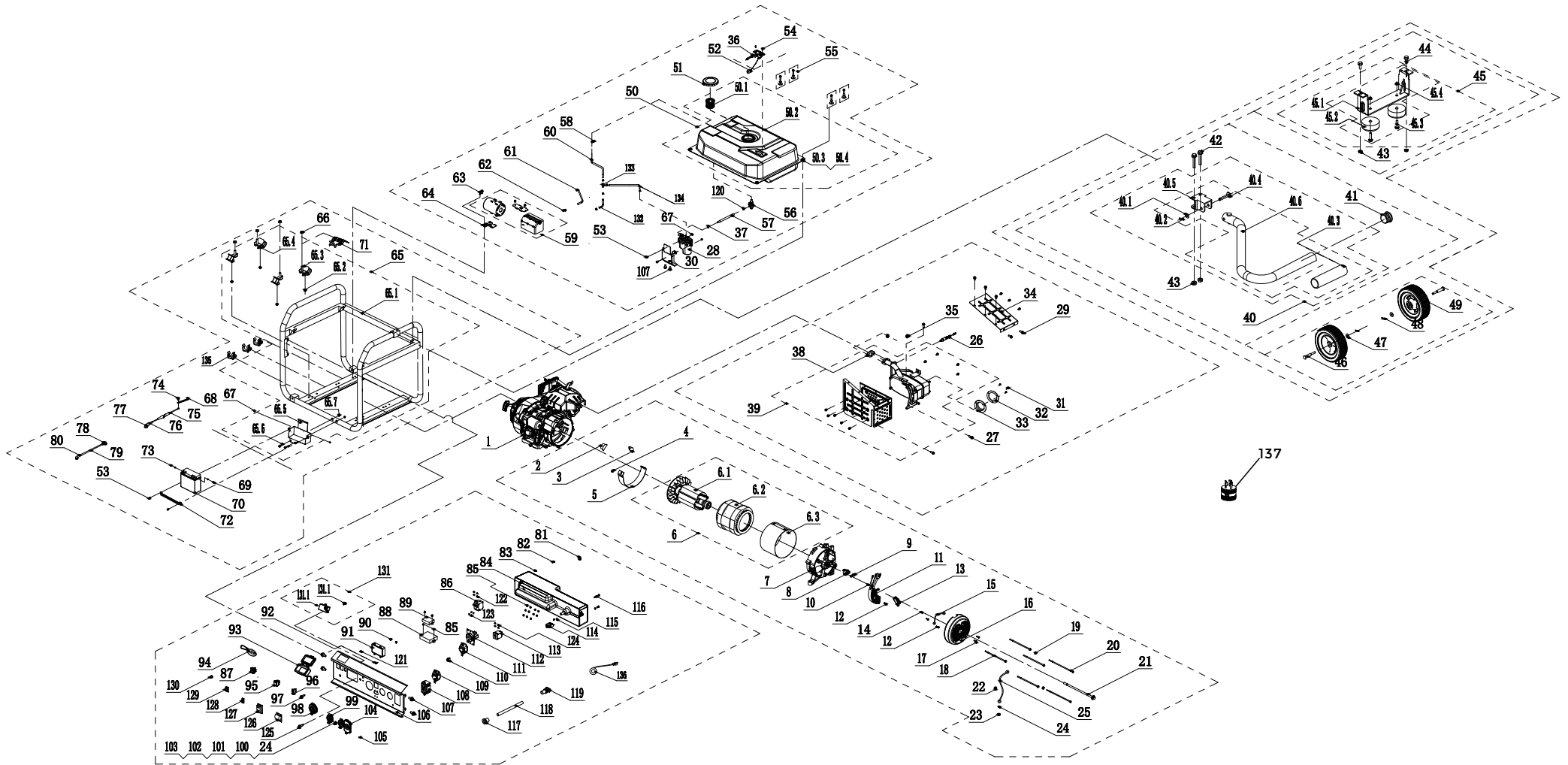

# 439cc ENGINE PARTS DIAGRAM

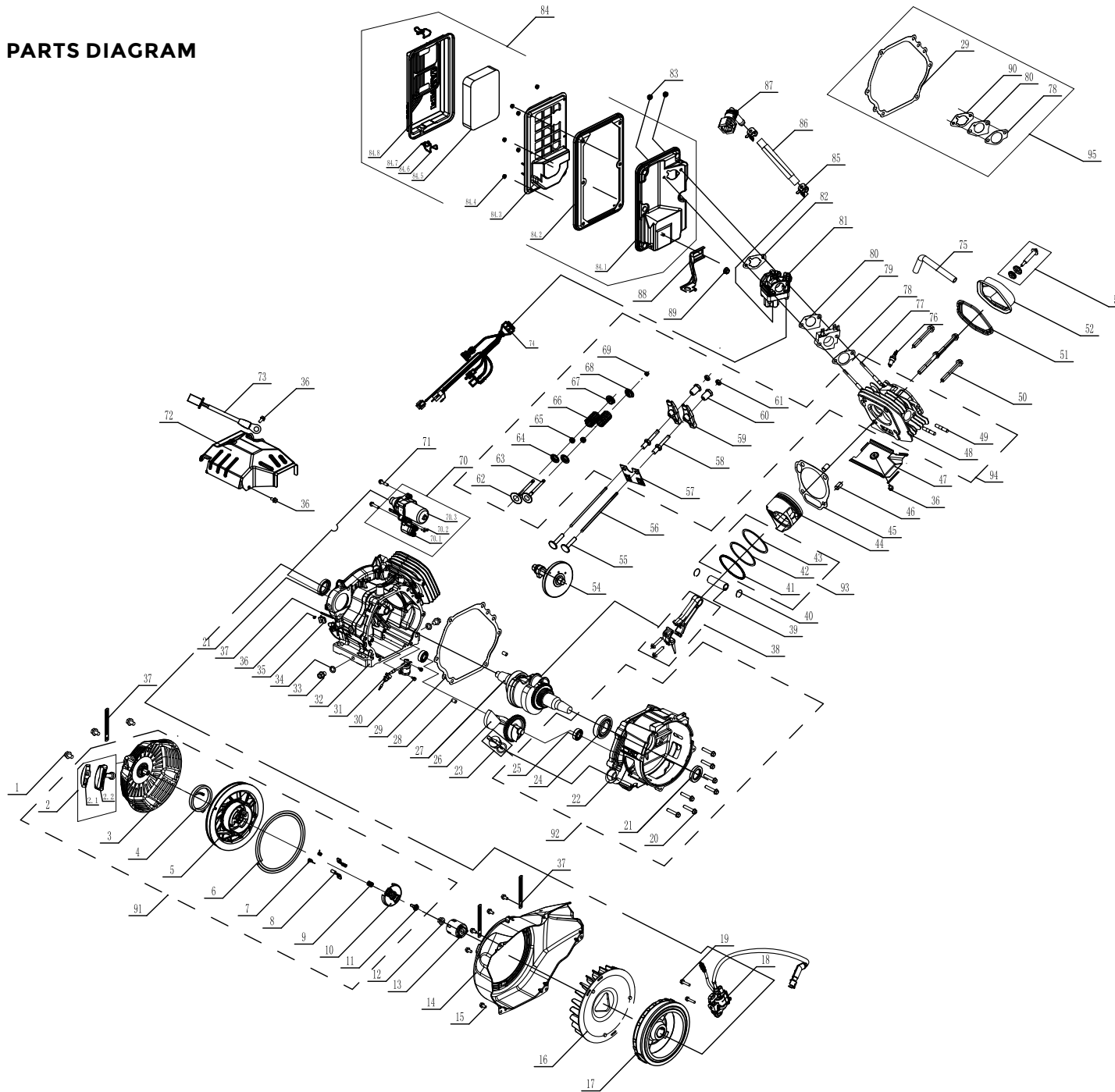

# Parts Diagrams - Parts Lists - Wiring Diagram

## P07505 Portable Generator

NO.	Part Number	Description	Qty.	NO.	Part Number	Description	Qty.
1	380467004	Engine Subassembly	1	42	357713527	Flange Bolt M8×50	2
2	357713501	Rubber Cap B	1	43	336713558	Nut M8	4
3	357713524	Rubber Cap A	1	44	336713559	Flange Bolt M8×16	2
4	336713528	Flange Bolt M6×8	1	45	357413506	Support Leg Assembly	1
5	357713573	Generator Wind Shield	1	45.1	357713538	Support Leg	1
6	380413501	Alternator Assy	1	45.2	336713557	Rubber, Support	2
6.1	380713535	Rotor Assy	1	45.3	336718302	Flange Bolt M6×12	4
6.2	380713536	Stator Assy	1	45.4	336718314	Nut M6	2
6.3	380713503	Stator Cover	1	46	357713535	Axle Comp	2
7	357713506	Generator End Cover	1	47	357713514	Washer Ø10	2
8	357713507	Carbon Brush Assembly	1	48	357713536	Lock Pin	2
9	336713525	Carbon Brush Holder	1	49	357713534	Wheel	2
10	357713563	Bolt & washer Assemblies	1	50	357713528	Fuel Tank & Decals Assy.	1
11	357713564	AVR	1	50.1	336713548	Fuel Filter, Wire Mesh	1
12	336713519	Flange Bolt M5×16	3	50.2	357713528	Fuel Tank Assy.	1
13	336713523	Terminal Block	1	50.3	336713542	Grommet, Fuel Tank	4
14	336713520	Bolt M5×16	2	50.4	357713600	Bushing	4
15	357713599	Neutral Wire	1	51	336713549	Fuel Cap	1
16	357713509	Generator End Cover Cap	1	52	380417010	Fuel Gauge Assy.	1
17	336718309	Flange Bolt M5×12	2	53	336718329	Flange Bolt M6×15	4
18	380713506	Flange Bolt M6×179	4	54	380717011	Screw M5×14	2
19	336713577	Nut M5	2	55	310715064	Bolt M6×20	4
20	380713507	Side Cover Bolt M5×214	2	56	380417011	Fuel Valve	1
21	380713508	Flange Bolt M10×265	1	57	375727002	Hose, Fuel	1
22	336718301	Flange Bolt M6×12	1	58	336713540	Clip Ø8×6	2
23	336713517	Nut M6	1	59	380428300	Carbon Canister Assy	1
24	336713516	External Star Washer Ø6	2	60	380427010	Vapor Hose 1	1
25	336713514	Ground Wire	1	61	380427011	Vapor Hose 2	1
26	380467005	Oxygen Sensor	1	62	330713509	Clip (Ø8.7×8)	1
27	336713531	Flange. Bolt M8×20	2	63	336713559	Flange Bolt M8×16	2
28	380467006	Fuel Pump Assy.	1	64	336713638	Carbon Canister Holder	1
29	380717008	Screw&washer Assy M5×14	16	65	380417012	Frame Assy	1
30	380717009	Fuel Pump Bracket	1	65.1	380417013	Frame	1
31	380717010	Screw M5×14	3	65.2	336713558	Nut M8	4
32	393713026	Holder, Spark Arrester	1	65.3	357713532	Isolator II	2
33	393713025	Arrester, Spark	1	65.4	357713533	Isolator I	2
34	393713003	Muffler Cover	1	65.5	357418300	Battery Bracket	1
35	336713558	Nut M8	2	65.6	357713527	Flange Bolt M8×50	2
36	375718321	Clamp	1	65.7	336713558	Nut M8	2
37	375717009	Clamp	1	66	357713531	Nut M10	4
38	357713520	Gskt., Ext.	1	67	336718314	Nut M6	4
39	380417009	Muff., Assy.	1	68	330723528	Wire Clip	1
40	357413505	Handle Assembly	1	69	330723583	Screw/washer Assembly M5×10	2
40.1	336713591	Flat Washer(Ø8.2×Ø17×0.8)	1	70	357713553	Battery	1
40.2	336713590	Cotter Pin,handle	1	71	375717010	Heat shield	1
40.3	357713519	Cover, Handle	1	72	357713551	Battery Pressing Bracket	1
40.4	336713594	Axle Pin,handle	1	73	336713578	Nut M5	2
40.5	357713526	Bracket, Handle	1	74	336713528	Flange.bolt M6×8	1
40.6	357713522	Handle Assy.	1	75	357713607	Battery Cable(male 180mm)	1
41	380728301	Stuffy	1	76	336713693	Battery Cable(female 180mm)	1

# Parts Diagrams - Parts Lists - Wiring Diagram

NO.	Part Number	Description	Qty.	NO.	Part Number	Description	Qty.
77	336713842	Black Boot	1	127	392758301	Cover	1
78	336713611	Boot,starter	1	128	336727009	Switch Cover	1
79	336718372	Red Wire	1	129	336755004	Engine Switch Cover	1
80	336713841	Red Boot	1	130	336755005	Circuit Breaker Cover	4
81	336713564	Sheath,breather Tube	1	131	380457015	Co Module	1
82	393713043	Screw M5×14	3	132	380427012	Vapor Hose 3	1
83	329713608	Flat Washers	2	133	380427013	Tee Connector	1
84	375727003	Control Box	1	134	380427014	Vapor Hose 4	1
85	336718324	Nut M4	18	135	375717011	Clamp	3
86	375713001	Circuit Breaker 31a	1	136	375457012	Control Module	1
87	380457009	Switch	1	137	336457007	Adaptor L5-30P to TT-30R	1
88	380457010	Charge Module	1				
89	380457011	Control Module	1				
90	336713567	Nut M3	4				
91	380457012	Lcd	1				
92	336713619	Switch	1				
93	336713644	Remote Holder	1				
94	336713642	Remote Control	1				
95	336713827	Switch	1				
96	380457013	Switch	1				
97	336713618	Pilot Lamp	1				
98	336713574	Outlet Cover TT-30R	1				
99	336713573	Outlet Cover L5-30R	2				
100	380713512	Bolt M6×22	1				
101	380713515	Nut M6	2				
102	380713514	Lock Washer Φ6	2				
103	380713513	Flat Washer Φ6	2				
104	357713541	Outlet Cover 5-20R GFCI	1				
105	393758300	Fuse	1				
106	380457014	Control Panel	1				
107	336718302	Flange Bolt M6×12	4				
108	357713588	Receptacle 5-20R GFCI	1				
109	336713832	Receptacle L5-30R Heightened	1				
110	336723612	Sheath, Wire	1				
111	336713601	Receptacle L14-30R	1				
112	380713518	Receptacle 14-50R	1				
113	380713526	Circuit Breaker Amp 30A	1				
114	336713585	Circuit Breaker Amp 20A	1				
115	336713569	Screw&washer Assy M4×8	2				
116	336713589	Screw&washer Assy M5×38	1				
117	357713545	Grommet	1				
118	357713546	Sleeve	1				
119	357713548	Grommet	1				
120	380715500	Clip (φ8.2×b8)	2				
121	336718383	Screw&washer Assy M4×14	1				
122	380713562	Screw&washer Assy M5×8	4				
123	336718368	Screw&washer Assy M3×6	4				
124	336713569	Screw&washer Assy M4×8	4				
125	336755002	Indicator Light	1				
126	392758302	Cover	1				

# Parts Diagrams - Parts Lists - Wiring Diagram

## FIRMAN 439cc Engine

NO.	Part Number	Description	Qty.	NO.	Part Number	Description	Qty.
1	336718310	Flg. Bolt M6×8	3	49	357723528	Exhaust Valves Stud Bolt	2
2	357723577	Grip,starter	1	50	357723530	Flange Bolt M10×80	4
2.1	336728300	Handle Core	1	51	357723525	Gasket, Cylinder Head Cover	1
2.2	336728301	Recoil Starter Knob	1	52	357723526	Cover Subassembly, Cylinder Head	1
3	357723579	Case Comp.,recoil Starter	1	53	357723527	Bolt	1
4	357723580	Spring,starter Return	1	54	357723508	Camshaft Assy.	1
5	357723582	Pulley, recoil Starter	1	55	357723543	Tappet, Valve	2
6	393723006	Cord	1	56	357723542	Push Rod	2
7	336723589	Spring,patchet	2	57	357723538	Plate Subassembly, Lifter Stopper	1
8	336723590	Patchet,starter	2	58	336723537	Bolt, Valve Adjusting	2
9	336723592	Clip Sprg.,pawl Guide	1	59	357723532	Rocker, Valve	2
10	336723591	Pawl Guide	1	60	336723529	Nut Valve Adjusting	2
11	336723593	Screw,pawl Guide	1	61	336723528	Nut, Valve Lock	2
12	357723571	Nut, Shaft	1	62	380723507	Valve,in,take	1
13	357723572	Pulley,starter	1	63	380723508	Valve, Exhaust	1
14	357723570	Fan Cover Comp	1	64	357723537	Retainer, Valve	2
15	336718302	Flange Bolt M6×12	5	65	357723536	Oil Seal, valve	2
16	380723511	Cooling Fan	1	66	357723535	Spring, valve	2
17	380467006	Flywheel Comp	1	67	357723533	Retainer, Intake Valve	1
18	380467007	Ignition Coil	1	68	357723534	Retainer, Exhaust Valve	1
19	336718311	Flange Bolt M6×29	2	69	357723531	Rotator, Valve	1
20	357723516	Flange Bolt M8×40	7	70	380467010	Starter Motor Assembly	1
21	357723515	Seal, Oil	2	70.1	393418303	Relay Assy	1
22	380467008	Cover,crankcase	1	70.2	336713519	Flange. Bolt M5×16	2
23	357723513	Oil Dipstick Assy	1	70.3	380457006	Starter Motor	1
24	357723506	Bearing	1	71	357723575	Flange Bolt M8×35	2
25	357723505	Bearing	2	72	380467011	Wind Guide, Top	1
26	357723507	Balance Shaft	1	73	380467012	Cylinder Temperature Sensor	1
27	380723501	Crankshaft	1	74	380467013	Wire	1
28	336723501	Locating Pins	2	75	357723529	Breather Tube	1
29	357723512	Gasket, Crankcase	1	76	336723556	Spark Plug	1
30	357723504	Flange Bolt M6×15	2	77	357723548	Stud, Intake	2
31	375457013	Sensor, Engine Oil	1	78	357723549	Gskt.,insulator	1
32	380467009	Crankcase Subassembly.	1	79	357723550	Plate, Carburetor Insulator	1
33	380717007	Bolt, Drain Plug	2	80	357723551	Gasket, Carburetor	1
34	357723502	Washer,drain Bolt	2	81	380467014	Throttle Assy	1
35	336728303	Sheath,wire	1	82	357723554	Gasket, Air Cleaner	1
36	336718301	Flange Bolt M6×12	3	83	336723555	Nut M6	2
37	330723528	Wire Clip	4	84	380467015	Air Cleaner Assy	1
38	357723517	Rod, Connecting	1	84.1	380467016	Elbow, Air Cleaner	1
39	357723519	Pin, Piston	1	84.2	393718310	Seal	1
40	357723518	Clip, Piston Pin	2	84.3	357723556	Clapboard	1
41	380723503	Ring,oil	1	84.4	336713578	Nut M5	6
42	380723504	Ring, Second Piston	1	84.5	357723558	Element, Air Cleaner	1
43	380723505	Ring,first Piston	1	84.6	393728305	Lock I	1
44	380723502	Piston	1	84.7	393728306	Lock II	1
45	375717006	Gasket,cyl.head	1	84.8	357723559	Cover, Air Cleaner	1
46	357723544	Locating Pins(φ12×20)	2	85	333717020	Clip (φ12×b8)	1
47	357723521	Air Guide Lower	1	86	380427015	Fuel Hose	1
48	375717007	Cylinder Head	1	87	380427016	Quick Connector	1



## Wiring Diagram

B	BLACK	BR	BROWN
Y	YELLOW	BRW	BROWN/BLACK
L	BLUE	BRW/WH	BROWN/WHITE
G	GREEN	W/WH	WHITE/BLACK
R	RED	W/Y	WHITE/YELLOW
W	WHITE	W/BL	WHITE/BLUE
P	PINK	W/GR	WHITE/GREEN
RW	RED/WHITE	R/B	RED/BLACK
LW	BLUE/WHITE	P	PURPLE

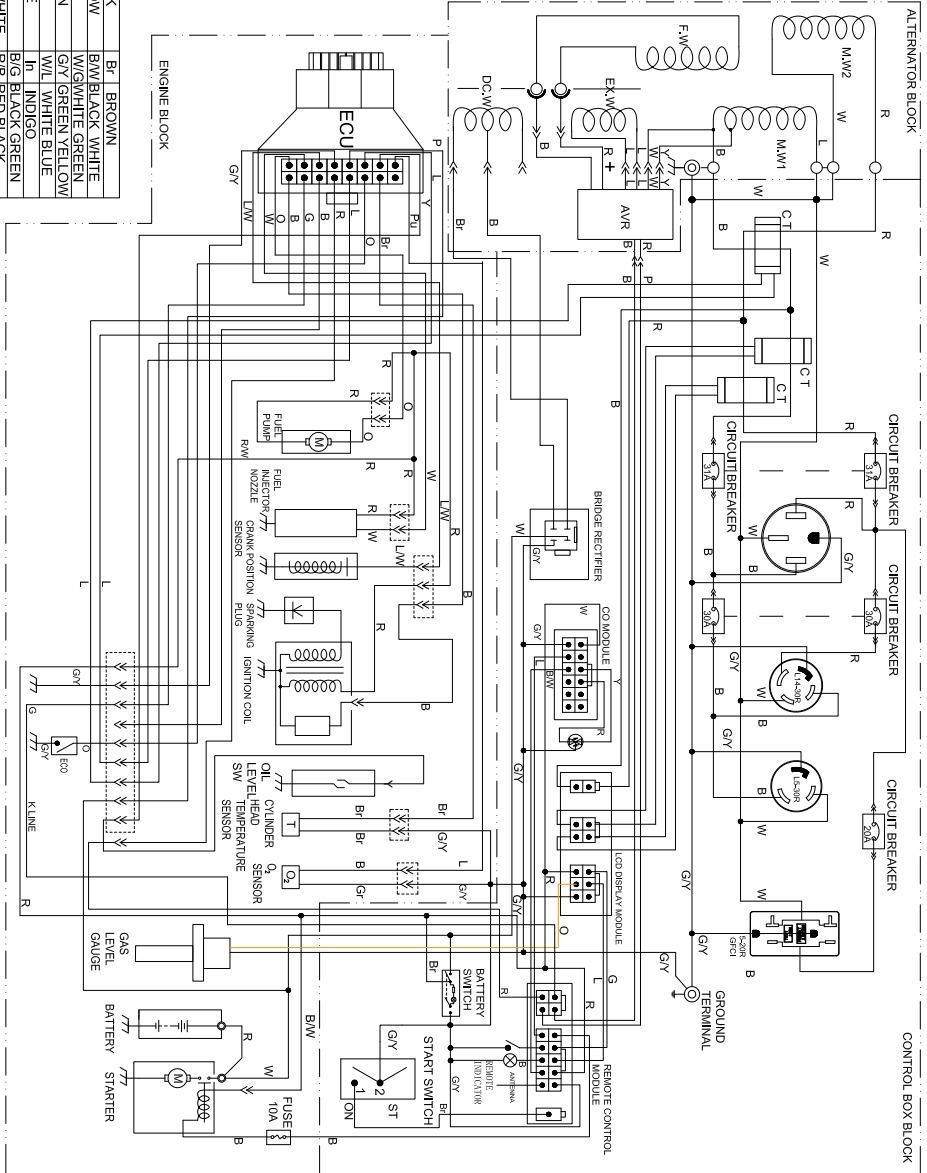

# Service - Warranty

---

For service information contact FIRMAN customer service at 1-844-347-6261 or at [www.firmanpowerequipment.com](http://www.firmanpowerequipment.com) to obtain warranty service information or to order replacement parts or accessories.

## HOW TO ORDER REPLACEMENT PARTS

Even quality-built equipment such as this electric generator may need occasional replacement parts to maintain it in good condition over the years. To order replacement parts, please give the following information:

- Model No. Rev. Level and Serial No. found on the Data Decal.
- Parts number or numbers as shown in the Parts List section.
- A brief description of the trouble with the generator.

## FIRMAN 3 Years Limited Warranty

### Warranty Qualifications

Register your product using the QR code provided or at [www.firmanpowerequipment.com](http://www.firmanpowerequipment.com). FIRMAN will also register the warranty upon receipt of your Warranty Registration Card and a copy of your sales receipt from one of FIRMAN's retail locations as proof of purchase. Please submit your warranty registration and your proof of purchase within ten(10) days of the date of purchase.



### Repair/Replacement Warranty

FIRMAN warrants to the original purchaser that the mechanical and electrical components will be free of defects in material and workmanship for a period of one (1) year (parts and labor) and 3 years (parts and technical support) from the original date of purchase 90 days [parts and labor] and 180 days [parts] for commercial & industrial use. Transportation charges on product submitted for repair or replacement under this warranty are the sole responsibility of the purchaser. This warranty only applies to the original purchaser and is not transferable.

### Do Not Return the Unit to the Place of Purchase

Contact the FIRMAN customer service and FIRMAN will troubleshoot any issue via phone or e-mail. If the problem is not corrected by this method, FIRMAN will, at its option, authorize evaluation, repair or replacement of the defective part or component at a FIRMAN Service Center. FIRMAN will provide you with a case number for warranty service. Please keep it for future reference. Repairs or replacements without prior authorization, or at an unauthorized repair facility, will not be covered by this warranty.

### Warranty Exclusions

This warranty does not cover the following repairs and equipment.

#### Normal Wear

Your product needs periodic parts and service to perform well. This warranty does not cover repair when normal use has exhausted the life of a part or the equipment as a whole.



## Installation, Use and Maintenance

This warranty will not apply to parts and/or labor if your product is deemed to have been misused, neglected, involved in an accident, abused, loaded beyond the generator's limits, modified, installed improperly or connected incorrectly to any electrical component. Normal maintenance is not covered by this warranty.

### Other Exclusions

This warranty excludes:

- cosmetic defects such as paint, decals, etc.
- wear items
- accessory parts
- failures due to acts of God and other force majeure events beyond the manufacturer's control
- problems caused by parts that are not original FIRMAN parts
- units used for prime power in place of existing utility power where utility is present or in place of utility power where utility power service does not normally exist.

## Limits of Implied Warranty and Consequential Damage

FIRMAN disclaims any obligation to cover any loss of time, use of this product, freight, or any incidental or consequential claim by anyone from using this product. THIS WARRANTY IS IN LIEU OF ALL OTHER WARRANTIES, EXPRESS OR IMPLIED, INCLUDING WARRANTIES OF MERCHANTABILITY OR FITNESS FOR A PARTICULAR PURPOSE.

A unit provided as an exchange will be subject to the warranty of the original unit. The length of the warranty governing the exchanged unit will remain calculated by reference to the purchase date of the original unit.

This warranty gives you certain legal rights which may change from state to state. Your state may also have other rights you may be entitled to that are not listed within this warranty.

## Contact Information

You may contact FIRMAN at:

### Address

Firman Power Equipment Inc.  
Attn: Customer Service  
8644 W. Ludlow Dr.  
Peoria, AZ 85381  
[www.firmanpowerequipment.com](http://www.firmanpowerequipment.com)

We are FIRMAN POWER - And we are here for you.

# Service - Warranty

---

## FIRMAN POWER EQUIPMENT INC. Emission Control System Warranty

### CALIFORNIA AND FEDERAL EXHAUST AND EVAPORATIVE EMISSIONS CONTROL WARRANTY STATEMENT

#### YOUR WARRANTY RIGHTS AND OBLIGATIONS

The California Air Resources Board, US Environmental Protection Agency ("US EPA") and FIRMAN POWER EQUIPMENT INC. (FIRMAN) are pleased to explain the emissions control systems warranty on your 2022-2023 or later Small Off-Road Engine ("SORE") and engine powered equipment. In California, new equipment that use small off-road engines must be designed, built and equipped to meet the State's stringent anti-smog standards. FIRMAN must warrant the emissions control systems on your SORE and engine powered equipment for the periods of time listed below provided there has been no abuse, neglect or improper maintenance of your small off-road engine or equipment leading to the failure of the emissions control system. Your emissions control system may include parts such as the carburetor or fuel-injection system, the ignition system, catalytic converter, fuel tanks, fuel lines (for liquid fuel and fuel vapors), fuel caps, valves, canisters, filters, clamps and other associated components. Also included may be hoses, belts, connectors, and other emission-related assemblies.

Where a warrantable condition exists, FIRMAN will repair your SORE and engine powered equipment at no cost to you including diagnosis, parts and labor.

#### MANUFACTURER'S WARRANTY COVERAGE:

The exhaust and evaporative emissions control system on your small off-road engine and engine powered equipment is warranted for two years. If any emissions-related part on your small off-road engine and engine powered equipment is defective, the part will be repaired or replaced by FIRMAN.

#### OWNER'S WARRANTY RESPONSIBILITIES:

As the SORE and engine powered equipment owner, you are responsible for the performance of the required maintenance listed in your operator's manual. FIRMAN recommends that you retain all receipts covering maintenance on your SORE and engine powered equipment, but FIRMAN cannot deny warranty coverage solely for the lack of receipts or for your failure to ensure the performance of all scheduled maintenance.

As the SORE and engine powered equipment owner, you should however be aware that FIRMAN may deny you warranty coverage if your small off-road engine or engine powered equipment or a part has failed due to abuse, neglect, or improper maintenance or unapproved modifications.

You are responsible for presenting your small off-road engine and engine powered equipment to a FIRMAN distribution center or service center as soon as the problem exists. The warranty repairs shall be completed in a reasonable amount of time, not to exceed 30 days.

If you have any questions regarding your warranty rights and responsibilities, you should contact FIRMAN at 1-844-347-6261.

#### FIRMAN Emission Control Defects Warranty Provisions

The warranty period begins on the date the engine/equipment is delivered to an ultimate purchaser. FIRMAN warrants to the ultimate purchaser and each subsequent purchaser that the engine is:

Designed, built, and equipped so as to conform with all applicable regulations adopted by the Air Resources Board and US EPA; and Free from defects in materials and workmanship that cause the failure of a warranted part to be identical in all material respects to the part as described in the engine manufacturers application for certification.

##### The warranty on emissions-related parts is as follows:

- (1) Any warranted part that is not scheduled for replacement as required maintenance in the owner's manual supplied, is warranted for the warranty period stated above. If any such part fails during the period of warranty coverage, the part will be repaired or replaced by FIRMAN at no charge to the owner. Any such part repaired or replaced under the warranty will be warranted for the remaining warranty period.
- (2) Any warranted part that is scheduled only for regular inspection in the owner's manual supplied, is warranted for the warranty period stated above. Any such part repaired or replaced under warranty will be warranted for the remaining warranty period.
- (3) Any warranted part that is scheduled for replacement as required maintenance in the owner's manual supplied, is warranted for the period of time prior to the first scheduled replacement point for that part. If the part fails prior to the first scheduled replacement, the part will be repaired or replaced by FIRMAN at no charge to the owner. Any such part repaired or replaced under warranty will be warranted for the remainder of the period prior to the first scheduled replacement point for the part.
- (4) Repair or replacement of any warranted part under the warranty must be performed at no charge to the owner at a warranty station.
- (5) Notwithstanding the provisions of Subsection (4) above, warranty services or repairs must be provided by FIRMAN that are franchised to service the subject engines.
- (6) The owner must not be charged for diagnostic labor that leads to the determination that a warranted part is in fact defective, provided that such diagnostic work is performed at a warranty station.
- (7) FIRMAN is liable for damages to other engine components proximately caused by a failure under warranty of any warranted part.

(8) Throughout the emissions warranty period defined in Subsection (b)(2), FIRMAN will maintain a supply of warranted parts sufficient to meet the expected demand for such parts.

(9) Any replacement part may be used in the performance of any warranty maintenance or repairs and must be provided without charge to the owner. Such use will not reduce the warranty obligations of the manufacturer.

(10) Add-on or modified parts that are not exempted by the Air Resources Board may not be used. The use of any non-exempted add-on or modified parts by the ultimate purchaser will be grounds for disallowing a warranty claim.

The manufacturer will not be liable to warrant failures of warranted parts caused by the use of a non-exempted add-on or modified part.

## PARTS COVERED BY WARRANTY

Listed below are the parts (if equipped) covered by the Federal and California Emission Control System Warranty.

1. Ignition system including: <ul style="list-style-type: none"><li>- Spark plug</li><li>- Ignition coil</li></ul>	4. Air induction system including: <ul style="list-style-type: none"><li>- Intake pipe/manifold</li><li>- Air cleaner</li></ul>
2. Fuel metering system: <ul style="list-style-type: none"><li>- Fuel tank</li><li>- Fuel cap</li><li>- Fuel lines (for liquid fuel and fuel vapors) and related fittings/clamps</li><li>- Fuel regulator, carburetor and internal parts.</li></ul>	5. Crankcase breather assembly including: <ul style="list-style-type: none"><li>- Breather connection tube</li></ul>
3. Catalytic muffler assembly including: <ul style="list-style-type: none"><li>- Exhaust manifold</li><li>- Catalytic converter</li><li>- Muffler gasket</li><li>-pulse valve</li></ul>	6. Fuel tank evaporative emission control system including: <ul style="list-style-type: none"><li>- Purge valves</li><li>- Carbon canister</li><li>- Vapor hoses and fitting/clamps</li></ul>

## Limitations

This Emission Control System Warranty shall not cover any of the following:

- (a) Consequential damages such as loss of time, inconvenience, loss of use of the engine or equipment, etc.
- (b) Diagnosis and inspection fees that do not result in eligible warranty service being performed.

FIRMAN POWER EQUIPMENT INC.  
[www.firmanpowerequipment.com](http://www.firmanpowerequipment.com)

# **FOLLOW US ON SOCIAL MEDIA**

**USE**

**#EVERYGENERATORTELLSASTORY™**

**FOR YOUR CHANCE TO WIN FIRMAN SWAG**



**FIRMAN POWER EQUIPMENT INC.  
8644 W. Ludlow Dr.  
Peoria, AZ 85381  
1-844-347-6261  
[www.firmanpowerequipment.com](http://www.firmanpowerequipment.com)**

All rights reserved. Any reprinting or unauthorized use without the written permission is expressly prohibited.  
P/N:375745055 Rev:03