

KOHLER® Aegis

LH640, LH685, LH690

Owner's Manual

EN

ESS

FRC

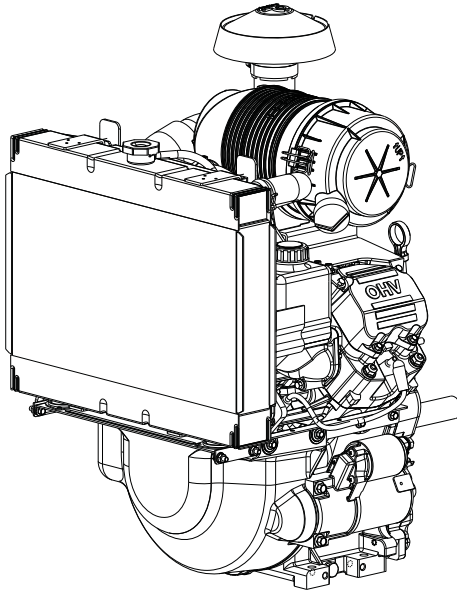

IMPORTANT: Read all safety precautions and instructions carefully before operating equipment. Refer to operating instruction of equipment that this engine powers.

Ensure engine is stopped and level before performing any maintenance or service.

Warranty coverage as outlined in the warranty card and on KohlerEngines.com. Please review carefully as it provides you specific rights and obligations.

To maintain compliance with applicable emission regulations, exhaust system backpressure may not exceed limits which can be found on KohlerEngines.com. Search by Model No., select Read More, then select Specs tab.

Record engine information to reference when ordering parts or obtaining warranty coverage.

Engine Model _____

Specification _____

Serial Number _____

Purchase Date _____

Safety Precautions

⚠ WARNING: A hazard that could result in death, serious injury, or substantial property damage.

⚠ CAUTION: A hazard that could result in minor personal injury or property damage.

NOTE: is used to notify people of important installation, operation, or maintenance information.

	⚠ WARNING Explosive Fuel can cause fires and severe burns.
	Do not fill fuel tank while engine is hot or running.

Gasoline is extremely flammable and its vapors can explode if ignited. Store gasoline only in approved containers, in well ventilated, unoccupied buildings, away from sparks or flames. Spilled fuel could ignite if it comes in contact with hot parts or sparks from ignition. Never use gasoline as a cleaning agent.

	⚠ WARNING Carbon Monoxide can cause severe nausea, fainting or death.
	Avoid inhaling exhaust fumes.

Engine exhaust gases contain poisonous carbon monoxide. Carbon monoxide is odorless, colorless, and can cause death if inhaled.

	⚠ WARNING Accidental Starts can cause severe injury or death.
	Disconnect and ground spark plug lead(s) before servicing.

Before working on engine or equipment, disable engine as follows: 1) Disconnect spark plug lead(s). 2) Disconnect negative (-) battery cable from battery.

	⚠ WARNING Rotating Parts can cause severe injury.
	Stay away while engine is in operation.

Keep hands, feet, hair, and clothing away from all moving parts to prevent injury. Never operate engine with covers, shrouds, or guards removed.

	⚠ WARNING Hot liquid can cause severe burns.
	Do not loosen radiator cap while engine is operating or warm to touch.

Liquid coolant can get extremely hot from operation. Turning radiator cap when engine is hot can allow steam and scalding liquid to blow out and burn you severely. Shut off machine. Only remove radiator cap when cool enough to touch with bare hands. Slowly loosen cap to first stop to relieve pressure before removing completely.

	⚠ WARNING Hot Parts can cause severe burns.
	Do not touch engine while operating or just after stopping.

Never operate engine with heat shields or guards removed.

	⚠ CAUTION Electrical Shock can cause injury.
	Do not touch wires while engine is running.

California Proposition 65 Warning

Engine exhaust from this product contains chemicals known to State of California to cause cancer, birth defects, or other reproductive harm.

California Proposition 65 Warning

This product contains chemicals known to State of California to cause cancer, birth defects, or other reproductive harm.

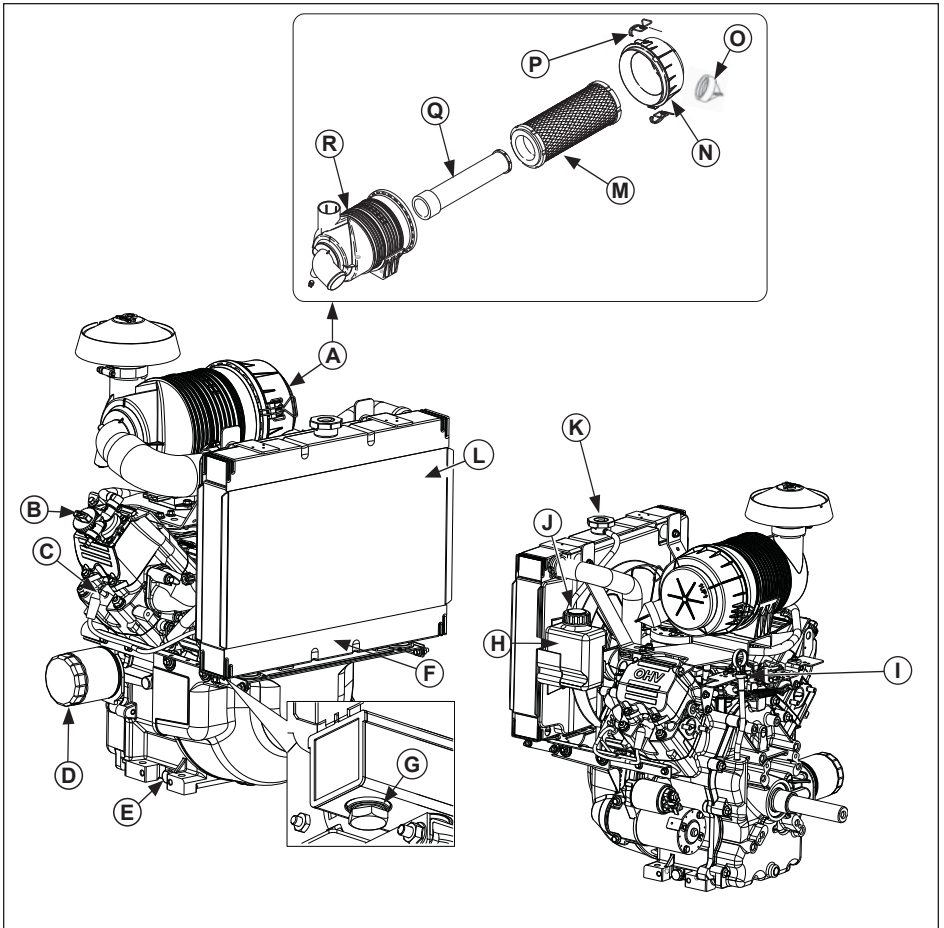

A	Heavy-Duty Air Cleaner	B	Oil Fill	C	Spark Plug	D	Oil Filter
E	Oil Drain Plug	F	Radiator	G	Radiator Drain Plug	H	Overflow Reservoir
I	Dipstick	J	Reservoir Cap	K	Radiator Cap	L	Intake Screen
M	Element	N	End Cap	O	Dust Ejector Valve	P	Retaining Clip
Q	Inner Element	R	Air Cleaner Housing				

Pre-Start Checklist

1. Check oil level. Add oil if low. Do not overfill.
2. Check fuel level. Add fuel if low. Check fuel system components and lines for leaks.
3. Check coolant level. Add coolant if low. Check coolant hoses and connections for leaks.
4. Check and clean cooling areas, air intake areas and external surfaces of engine (particularly after storage).
5. Check that air cleaner components and all shrouds, equipment covers, and guards are in place and securely fastened.
6. Check spark arrestor (if equipped).

Starting



WARNING

Carbon Monoxide can cause severe nausea, fainting or death. Avoid inhaling exhaust fumes.

Engine exhaust gases contain poisonous carbon monoxide. Carbon monoxide is odorless, colorless, and can cause death if inhaled.



WARNING

Rotating Parts can cause severe injury.

Stay away while engine is in operation.

Keep hands, feet, hair, and clothing away from all moving parts to prevent injury. Never operate engine with covers, shrouds, or guards removed.

NOTE: Do not crank engine continuously for more than 10 seconds. Allow a 60 second cool down period between starting attempts. Failure to follow these guidelines can burn out starter motor.

NOTE: Upon start-up, a metallic ticking may occur. Run engine for 5 minutes. If noise continues, run engine at mid throttle for 20 minutes. If noise persists, take engine to your local Kohler authorized dealer.

1. Place throttle control midway between slow and fast positions. Place choke control into ON position.
2. Turn key switch to START position. Release switch as soon as engine starts. If starter does not turn engine over, shut off key switch immediately. Do not make further attempts to start engine until condition is corrected. Do not jump start. See your Kohler authorized dealer for trouble analysis.
3. Cold engine: Gradually return choke control to OFF position after engine starts and warms up. Engine/equipment may be operated during warm-up period, but it may be necessary to leave choke partially on until engine warms up.

Warm engine: return choke to OFF position as soon as engine starts.

Cold Weather Starting Hints

1. Use proper oil for temperature expected.
2. Disengage all possible external loads.
3. Use fresh winter grade fuel. Winter grade fuel has higher volatility to improve starting.

Stopping

1. If possible, remove load by disengaging all PTO driven attachments.
2. Position throttle control between half and full throttle; stop engine.

Angle of Operation

Refer to operating instructions of equipment this engine powers. Do not operate this engine exceeding maximum angle of operation; see specification table. Engine damage could result from insufficient lubrication.

Engine Speed

NOTE: Do not tamper with governor setting to increase maximum engine speed. Overspeed is hazardous and will void warranty.

Cold Weather Operation

Anti-icing kits can be installed to improve cold weather operation and are available through your local Kohler authorized dealer.



High Altitude Operation

If this engine is operated at an altitude of 4000 ft. (1219 meters) or above, a high altitude carburetor kit is required. To obtain high altitude carburetor kit information or to find a Kohler authorized dealer, visit KohlerEngines.com or call 1-800-544-2444 (U.S. and Canada).

This engine should be operated in its original configuration below 4000 ft. (1219 meters).

Operating this engine with the wrong engine configuration at a given altitude may increase its emissions, decrease fuel efficiency and performance, and result in damage to the engine.

Maintenance Instructions

	 WARNING	Before working on engine or equipment, disable engine as follows: 1) Disconnect spark plug lead(s). 2) Disconnect negative (-) battery cable from battery.
	Accidental Starts can cause severe injury or death. Disconnect and ground spark plug lead(s) before servicing.	

Normal maintenance, replacement or repair of emission control devices and systems may be performed by any repair establishment or individual; however, warranty repairs must be performed by a Kohler authorized dealer found at KohlerEngines.com or 1-800-544-2444 (U.S. and Canada).

Maintenance Schedule

Every 200 Hours¹

- Change oil and oil filter.

Every 200 Hours

- Replace fuel filter.

Every 250 Hours¹

- Replace air cleaner element and check inner element.

Every 500 Hours¹

- Replace air cleaner inner element.

Every 500 Hours

- Replace spark plugs and set gap.

Every 1000 Hours

- Change engine coolant.

¹ Perform these procedures more frequently under severe, dusty, dirty conditions.

Oil Recommendations

We recommend use of Kohler oils for best performance. Other high-quality detergent oils (including synthetic) of API (American Petroleum Institute) service class SJ or higher are acceptable. Select viscosity based on air temperature at time of operation as shown in table below.

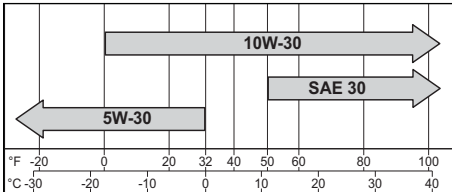

Check Oil Level

NOTE: To prevent extensive engine wear or damage, never run engine with oil level below or above operating range indicator on dipstick.

Ensure engine is cool. Clean oil fill/dipstick areas of any debris.

1. Remove dipstick; wipe oil off.
2. Reinsert dipstick into tube; press completely down.

3. Remove dipstick; check oil level. Level should be at top of indicator on dipstick.
4. If oil is low on indicator, add oil up to top of indicator mark.
5. Reinstall and secure dipstick.

Change Oil and Filter

Change oil while engine is warm.



1. Clean area around oil fill cap/dipstick, drain plug/oil drain valve. Remove drain plug and oil fill cap/dipstick. Allow oil to drain completely.
2. Clean area around oil filter. Place a container under filter to catch any oil and remove filter. Wipe off mounting surface. Reinstall drain plug. Torque to 10 ft. lb. (13.6 N·m).
3. Place new filter in shallow pan with open end up. Fill with new oil until oil reaches bottom of threads. Allow 2 minutes for oil to be absorbed by filter material.
4. Apply a thin film of clean oil to rubber gasket on new filter.
5. Refer to instructions on oil filter for proper installation.
6. Fill crankcase with new oil. Level should be at top of indicator on dipstick.

7. Reinstall oil fill cap/dipstick and tighten securely.
8. Start engine; check for oil leaks. Stop engine; correct leaks. Recheck oil level.
9. Dispose of used oil and filter in accordance with local ordinances.

Oil Sentry™ (if equipped)

This switch is designed to prevent engine from starting in a low oil or no oil condition. Oil Sentry™ may not shut down a running engine before damage occurs. In some applications this switch may activate a warning signal. Read your equipment manuals for more information.

Fuel Recommendations

	 WARNING
	Explosive Fuel can cause fires and severe burns. Do not fill fuel tank while engine is hot or running.
Gasoline is extremely flammable and its vapors can explode if ignited. Store gasoline only in approved containers, in well ventilated, unoccupied buildings, away from sparks or flames. Spilled fuel could ignite if it comes in contact with hot parts or sparks from ignition. Never use gasoline as a cleaning agent.	

NOTE: E15, E20 and E85 are NOT approved and should NOT be used; effects of old, stale or contaminated fuel are not warrantable.



Fuel must meet these requirements:

- Clean, fresh, unleaded gasoline.
- Octane rating of 87 (R+M)/2 or higher.
- Research Octane Number (RON) 90 octane minimum.
- Gasoline up to 10% ethyl alcohol, 90% unleaded is acceptable.
- Methyl Tertiary Butyl Ether (MTBE) and unleaded gasoline blend (max 15% MTBE by volume) are approved.
- Do not add oil to gasoline.
- Do not overfill fuel tank.
- Do not use gasoline older than 30 days.

Fuel Line

Low permeation fuel line must be installed on carbureted Kohler Co. engines to maintain EPA and CARB regulatory compliance.

Spark Plugs

	 CAUTION
	Electrical Shock can cause injury. Do not touch wires while engine is running.

Clean out spark plug recess. Remove plug and replace.

1. Check gap using wire feeler gauge. Adjust gap, see specification table for adjustment.
2. Install plug into cylinder head.
3. Torque plug to 20 ft. lb. (27 N-m).

Air Cleaner

NOTE: Operating engine with loose or damaged air cleaner components could cause premature wear and failure. Replace all bent or damaged components.

NOTE: Paper element cannot be blown out with compressed air.

1. Unhook retaining clips and remove end cap(s).
2. Check and clean inlet screen (if equipped).
3. Pull air cleaner element out of housing and replace. Check condition of inner element; replace when dirty.
4. Check all parts for wear, cracks, or damage, and that ejector area is clean.
5. Install new element(s).
6. Reinstall end cap(s) with dust ejector valve/screen down; secure with retaining clips.

Breather Tube

Ensure both ends of breather tube are properly connected.

Air Cooling

	⚠ WARNING
	Hot Parts can cause severe burns. Do not touch engine while operating or just after stopping.
Never operate engine with heat shields or guards removed.	

NOTE: Operating engine with a restricted air intake screen or radiator, damaged/broken fan assembly, or missing fan shroud will cause engine damage due to over heating.

Proper cooling is essential. To prevent over heating, clean screens, cooling fins, and other external surfaces of engine. Avoid spraying water at wiring harness or any electrical components. See Maintenance Schedule.

Cooling System

	⚠ WARNING
	Hot liquid can cause severe burns. Do not loosen radiator cap while engine is operating or warm to touch.
Liquid coolant can get extremely hot from operation. Turning radiator cap when engine is hot can allow steam and scalding liquid to blow out and burn you severely. Shut off machine. Only remove radiator cap when cool enough to touch with bare hands. Slowly loosen cap to first stop to relieve pressure before removing completely.	

NOTE: Do not operate engine without fan and cooling system functioning properly, or engine damage will occur.

This engine is liquid-cooled, circulating a mixture of ethylene glycol and water for dependable operation. Maintaining correct coolant level and cleaning any debris accumulation from inlet screen and radiator surfaces are critical to ensuring long life, proper system performance, and preventing overheating. A drive belt is designed and constructed for this application. Do not use a substitute belt. If belt is cracked, damaged, or adequate tension does not exist, have necessary servicing performed by a Kohler authorized dealer.

Drain Cooling System

1. Ensure engine is cool. When radiator is cool to touch, slowly loosen radiator cap to first stop and allow any pressure to bleed off. Then loosen it fully and remove it.

Loosen/remove radiator drain plug and allow coolant to drain. EN

2. If equipped, remove coolant drain plugs located on each side of engine block. Drain coolant into a suitable container. After coolant has drained completely, apply pipe sealant with Teflon® (Loctite® PST® 592™ or equivalent), to threads and reinstall plugs. Torque plugs to 325 in. lb. (36.7 N·m).
3. Remove overflow hose from reservoir. Unhook inboard retainer and slide reservoir out of supports. Pour out contents and wash or clean as required. Dispose of all old coolant in accordance with local ordinances.
4. Reinstall reservoir cap. Do not kink/pinch hose.
5. Flush cooling system.

Flush Cooling System

1. Fill cooling system with clean water and a cooling system cleaner recommended for aluminum engines. Follow directions on container.
2. Reinstall and tighten radiator cap.
3. Start and run engine for five minutes, or until it reaches operating temperature. Stop engine and allow it to cool.
4. Drain cooling system.
5. Fill cooling system.

Fill Cooling System

1. Check condition of cooling system hoses, clamps, and associated components. Replace as required.
2. Fill with 2.1 U.S. qt. (2.0 L) equal parts of ethylene glycol (anti-freeze) and water only. Distilled or deionized water is recommended, especially in areas where water contains a high mineral content. Propylene glycol based anti-freeze is not recommended.
3. Fill radiator with coolant mixture. Allow coolant to drain into lower areas. Fill overflow reservoir to a level between FULL and ADD marks. Reinstall radiator and reservoir caps.
4. Start and run engine for five minutes. Stop engine and allow to cool.
5. Recheck coolant level in reservoir. Coolant level should be between FULL and ADD marks. Add coolant to reservoir if required.

Repairs/Service Parts

We recommend that you use a Kohler authorized dealer for all maintenance, service, and replacement parts for engine. To find a Kohler authorized dealer visit KohlerEngines.com or call 1-800-544-2444 (U.S. and Canada).

Storage

If engine will be out of service for 2 months or more follow procedure below.

1. Coolant (anti-freeze) mixture should be in good condition and tested to guard against freezing in cold temperatures. Recommended 50/50 mixture will normally provide protection down to temperatures of -34°F (-37°C). If storage temperatures will fall below this, cooling system should be drained completely. A note should then be attached to equipment and/or engine as a reminder to refill cooling system before starting.
2. Add Kohler PRO Series fuel treatment or equivalent to fuel tank. Run engine 2-3 minutes to get stabilized fuel into fuel system (failures due to untreated fuel are not warrantable).
3. Change oil while engine is still warm from operation. Remove spark plug(s) and pour about 1 oz. of engine oil into cylinder(s). Replace spark plug(s) and crank engine slowly to distribute oil.
4. Disconnect negative (-) battery cable.
5. Store engine in a clean, dry place.

Troubleshooting

Do not attempt to service or replace major engine components, or any items that require special timing or adjustment procedures. This work should be performed by a Kohler authorized dealer.

Problem	Possible Cause							
	No Fuel	Improper Fuel	Dirt In Fuel Line	Dirty Debris Screen	Incorrect Oil Level	Engine Overloaded	Dirty Air Cleaner	Faulty Spark Plug
Will Not Start	•	•	•		•	•	•	•
Hard Starting		•	•		•	•	•	•
Stops Suddenly	•		•	•	•	•	•	•
Lacks Power		•	•	•	•	•	•	•
Operates Erratically		•	•	•		•	•	•
Knocks or Pings		•		•		•		•
Skips or Misfires		•	•	•			•	•
Backfires		•	•			•	•	•
Overheats		•	•	•	•	•	•	
High Fuel Consumption						•	•	•

Engine Specifications

Model	Bore	Stroke	Displacement	Oil Capacity (Refill)	Spark Plug Gap	Maximum Angle of Operation (@ full oil level)*
LH640	3.03 in. (77 mm)	2.6 in. (67 mm)	38.1 cu. in. (624 cc)	1.7-1.9 U.S. qt. (1.6-1.8 L)	0.03 in. (0.76 mm)	20°
LH685/LH690	3.15 in. (80 mm)		41.1 cu. in. (674 cc)			

*Exceeding maximum angle of operation may cause engine damage from insufficient lubrication.

Additional specification information can be found in service manual at KohlerEngines.com.

Exhaust Emission Control System for models LH640, LH685, and LH690 is EM for U.S. EPA, California, and Europe.

Any and all horsepower (hp) references by Kohler are Certified Power Ratings and per SAE J1940 & J1995 hp standards. Details on Certified Power Ratings can be found at KohlerEngines.com.