

HD 1.8/13 C
Ed

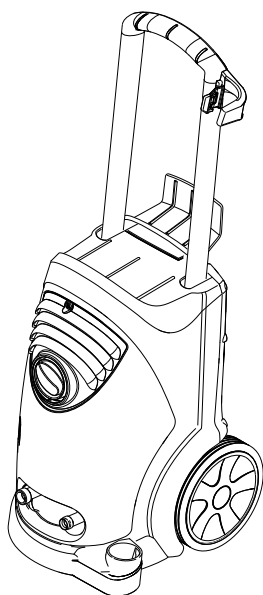

Register and win!
www.kaercher.com



59659360 03/13

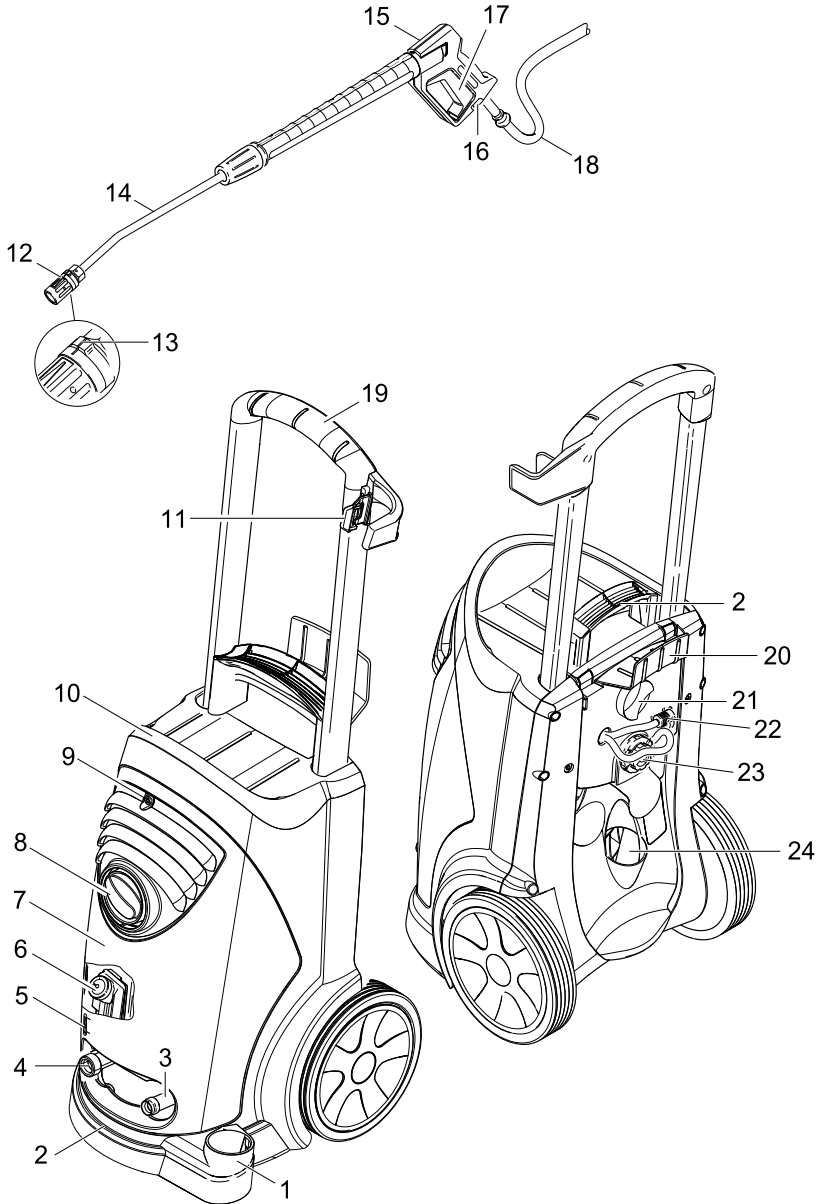
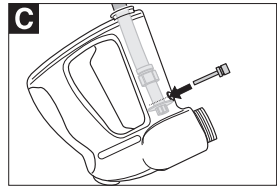
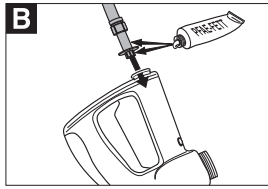
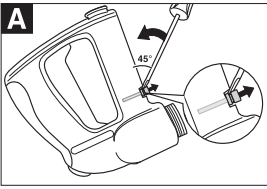

IMPORTANT SAFETY INSTRUCTIONS

⚠ WARNING

When using this product basic precautions should always be followed, including the following:

- 1 Read all the instructions before using the product.
- 2 High pressure jets can be dangerous if misused. The jet must not be directed at persons, animals, electrical devices, or the unit itself.
- 3 To reduce the risk of injury, close supervision is necessary when a product is used near children.
- 4 Know how to stop the product and bleed pressures quickly. Be thoroughly familiar with the controls.
- 5 Stay alert – watch what you are doing.
- 6 Wear safety goggles.
- 7 Do not use acids, alkaline, solvents, or any flammable material in this product. These products can cause physical injuries to the operator and irreversible damage to the machine.
- 8 Do not operate the product when fatigued or under the influence of alcohol or drugs.
- 9 Do not overreach or stand on unstable support. Keep good footing and balance at all times.
- 10 To reduce the risk of electrocution, keep all connections dry and off the ground. Do not touch plug with wet hands.
- 11 The Trigger Gun Safety Lock prevents the trigger from accidentally being engaged. This safety feature DOES NOT lock trigger in the ON position.

- 12 Keep operating area clear of all persons.
- 13 Follow the maintenance instructions specified in the manual.
- 14 This product is provided with a Ground Fault Circuit Interrupter built into the power cord plug. If replacement of the plug or cord is needed, use only identical replacement parts.
- 15 Risk of Injection or Injury – Do Not Direct Discharge Stream At Persons.
- 16 Do not use extension cord with this product.

GROUNDING INSTRUCTIONS

This product must be grounded. If it should malfunction or breakdown, grounding provides a path of least resistance for electric current to reduce the risk of electric shock. This product is equipped with a cord having an equipment-grounding conductor and a grounding plug. The plug must be plugged into an appropriate outlet that is properly installed and grounded in accordance with all local codes and ordinances.

⚠ DANGER

Improper connection of the equipment-grounding conductor can result in a risk of electrocution. Check with a qualified electrician or service personnel if you are in doubt as to whether the outlet is properly grounded. Do not modify the plug provided with the product - if it will not fit the outlet, have a proper outlet installed by a qualified electrician. Do not use any type of adapter with this product.

GROUND FAULT CIRCUIT INTERRUPTER PROTECTION

This Product is supplied with a Ground Fault Circuit Interrupter (GFCI) built into the power cord plug. This device provides additional protection from the risk of electric shock. If power is interrupted in the line, the GFCI will automatically re-close the circuit to the load after power is restored. Depending on the GFCI model, it may be necessary to manually operate the reset button to restore power to the GFCI load circuit. If the replacement of the plug or cord is needed use identical replacement parts.

WATER SUPPLY

(Cold Water Only)

⚠ CAUTION

When connecting the water inlet to the water supply mains, local regulations of your water company must be observed. In some areas the unit must not be connected directly to the public drinking water supply. This is to ensure that there is no feedback of chemicals into the water supply. Direct connection via a receiver tank or backflow preventer, for example, is permitted. Dirt in the feed water will damage the unit. To avoid this risk, we recommend fitting a water filter.

- Garden hose must be at least 3/4 inch in diameter.
- Flow rate of water supply must not fall below 2.5 GPM (gallons per minute).
- Flow rate can be determined by running the water for one minute into an empty 5-gallon container.
- The water supply temperature must not exceed 140°F/60°C.

- Never use the pressure washer to draw in water contaminated with solvents, e.g. paint thinners, gasoline, oil, etc.
- Always prevent debris from being drawn into the unit by using a clean water source. Use additional water filter.

CANADA

⚠ WARNING

Do not spray electrical apparatus and wiring.

Do not use with flammable liquids and toxic chemicals.

Injection hazard: equipment can cause serious injury if the spray penetrates the skin. do not point the gun at anyone or any part of the body. In case of penetration seek medical aid immediately.

This system is capable of producing 9000 kPa/1300 PSI. To avoid rupture and injury, do not operate this pump with components rated less than 9000 kPa/1300 PSI working pressure (including but not limited to spray guns, hose and hose connections).

Before servicing, cleaning or removing any parts, shut off power and relieve pressure.

EXTENSION CORDS

Use only 3-wire extension cords that have 3-prong grounding-type plugs and 3-pole cord connectors that accept the plug from the product. Use only extension cords that are intended for outdoor use. These extension cords are identified by a marking "Acceptable for use with out-door appliances: store indoors while not in use." Use only extension cords having an electrical rating not less than the rating of the product. Do not use damaged exten-

sion cords. Examine extension cord before using and replace if damaged. Do not abuse extension cord and do not yank on any cord to disconnect. Keep cord away from heat and sharp edges. Always disconnect the extension cord from the receptacle before disconnecting the product from the extension cord.

If you are using an extension cord, it should always be completely unwound from the cable drum.

Up to 100 ft = 12/3 AWG.

⚠ WARNING

To reduce the risk of electrocution, keep all connections dry and off the ground. Do not touch plug with wet hands.

SAVE THESE INSTRUCTIONS!



Please read and comply with these original instructions prior to the initial operation of your appliance and store them for later use or subsequent owners.

Contents

Device elements	EN	.. 3
Safety instructions	EN	.. 4
Proper use	EN	.. 4
Safety Devices	EN	.. 4
Environmental protection	EN	.. 5
Before Startup	EN	.. 5
Start up	EN	.. 5
Operation	EN	.. 7
Transport	EN	.. 8
Storage	EN	.. 8
Maintenance and care	EN	.. 9
Troubleshooting	EN	.. 9
Accessories and Spare Parts	EN	.. 10
Warranty	EN	.. 10
Technical specifications	EN	.. 11

Device elements

- Please unfold the front picture side
- 1 Storage compartment for nozzles
 - 2 Handle
 - 3 High pressure connection
 - 4 Water connection
 - 5 Oil level indicator
 - 6 Oil tank
 - 7 Cover
 - 8 Power switch
 - 9 Fastening screw for device hood
 - 10 Storage compartment for hoses
 - 11 Trigger gun storage clip
 - 12 Nozzle
 - 13 Marking of the nozzle
 - 14 Spray lance
 - 15 Hand blowing gun
 - 16 Safety lever
 - 17 Lever for hand spray gun
 - 18 High pressure hose

- 19 Push handle
- 20 Cable clamp
- 21 Clamping screw for pushing handle
- 22 Detergent suction hose with filter
- 23 Dosage valve for detergent
- 24 Accessory compartment

Safety instructions

- Before first start-up it is definitely necessary to read the operating instructions and safety indications Nr. 5.951-949!
- Please follow the national rules and regulations for fuel spray jets of the respective country.
- Please follow the national rules and regulations for accident prevention of the respective country. Fuel spray jets must be tested regularly and the results of these tests must be documented in writing.

Symbols in the operating instructions

Danger

Immediate danger that can cause severe injury or even death.

Warning

Possible hazardous situation that could lead to severe injury or even death.

Caution

Possible hazardous situation that could lead to mild injury to persons or damage to property.

Symbols on the machine



High-pressure jets can be dangerous if improperly used. The jet may not be directed at persons, animals, live electrical equipment or at the appliance itself.



According to the applicable regulations, the appliance must never be used on the drinking water net without a system separator. Use a suitable system separator manufactured by Kärcher; or, as an alternative, a system separator as per EN 12729 Type BA.

Water flowing through a system separator is considered non-drinkable.

Proper use

Use this high pressure cleaner exclusively for

- Cleaning using low pressure jet and detergent (for e.g. for cleaning machines, cars, buildings, tools),
- For cleaning using high pressure jet without detergent (for e.g. for cleaning facades, terraces, garden appliances).

For stubborn dirt, we recommend the use of the dirt blaster as a special accessory.

Safety Devices



Safety devices serve for the protection of the user and must not be put out of operation or bypassed with respect to their function.

Pressure switch

If the lever on the trigger gun is released the pressure switch turns off the pump, the high-pressure jet is stopped. If the lever is pulled the pump is turned on again.

The overflow valve and pressure switch are set and sealed at the factory. Setting only by customer service.

Environmental protection

	The packaging material can be recycled. Please do not throw the packaging material into household waste; please send it for recycling.
	Old appliances contain valuable materials that can be recycled; these should be sent for recycling. Batteries, oil, and similar substances must not enter the environment. Please dispose of your old appliances using appropriate collection systems.

Please do not release engine oil, fuel oil, diesel and petrol into the environment. Protect the ground and dispose of used oil in an environmentally-clean manner.

Notes about the ingredients (REACH)

You will find current information about the ingredients at:

www.kaercher.com/REACH

Before Startup

Check oil level

- Read the oil level display when the device is not running. The oil level must be above the two pointers.

Activate deaeration of oil container

- Unscrew the fastening screws of the device hood; remove the device hood.
- Cut off tip of oil container cover
- Fasten the device hood.

Attaching the Accessories

- Mount the nozzle on the spray pipe (markings on the adjustment ring at the top).
- Connect ray tube to hand spray gun
- Lever out the safety clip of the handspray gun using a screw-driver (Picture A).
- Place the hand-spray gun upside down and insert the end of the high pressure hose till the end. Ensure that the lose disc falls right below on the hose end (Picture B).
- Press the safety clip back into the hand-spray gun. The hose can be pulled out max. 1 mm if it has been installed correctly. Otherwise, it means the disc has been installed wrongly (picture C).
- Loosen the clamps of the pushing handle.
- Adjust the handle to the desired height.
- Tighten the clamps of the pushing handle.
- Fasten the high pressure hose to the high pressure connection.

Start up

Electrical connection

⚠ Danger

Danger of injury by electric shock.

The appliance may only be connected to an electrical supply which has been installed in accordance with IEC 60364.

The voltage indicated on the type plate must correspond to the voltage of the electrical source.

The minimum fuse rating required at the socket outlet is (see technical specifications).

The appliance should always be connected to the electrical mains using a

plug. It is forbidden to permanently connect the appliance to the power supply. The plug is only for mains separation.

Check the power cord with mains plug for damage before every use. If the power cord is damaged, please arrange immediately for the exchange by an authorized customer service or a skilled electrician.

The plug and coupling of the extension cable used must be watertight.

Use the extension cord that has an adequate cross-section (see "Technical Data") and unwind it fully from the cable drum.

Unsuitable extension cables can be hazardous. Only use extension cables outdoors which have been approved for this purpose and labelled with a sufficient cable cross section:

For connection values, see type plate/technical data.

GFCI INSTRUCTIONS

- **STEP 1:** Plug the Ground Fault Circuit Interrupter (GFCI) into a working outlet.
- **STEP 2:** Press "TEST", then press "RESET" to assure proper connection to power.

Note: The actual appearance of the GFCI may be different from this illustration.

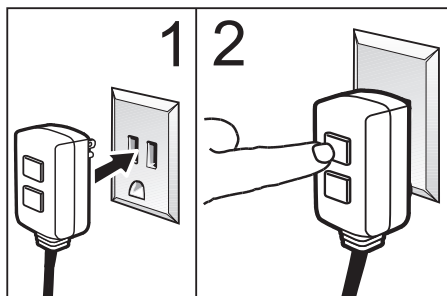

Water connection

Connection to the water supply

⚠ Warning

Observe regulations of water supplier. According to the applicable regulations, the appliance must never be used on the drinking water supply without a system separator. Use a suitable system separator manufactured by KÄRCHER; or, as an alternative, a system separator as per EN 12729 Type BA. Water flowing through a system separator is considered non-drinkable.



Caution

Always connect the system separator to the water supply, never directly to the appliance!

For connection values refer to technical specifications

- Connect the supply hose (max length 7.5 m, minimum diameter 1/2") to the water connection point of the machine and at the water supply point (for e.g. a tap).

Note

The supply hose is not included.

- Open the water supply.

Drawing in water from open reservoirs

- Screw the suction hose with filter (order no. 4.440-238.0) to the water connection.
- Deaerate the appliance:
Unscrew the nozzle.
Switch on the appliance and let it run until the water exiting is bubble-free.
At the end let the appliance run for approx. 10 seconds - then switch off. Repeat the procedure for a couple of times.
- Switch off the appliance and fit the nozzle again.

Operation

⚠ Danger

Risk of explosion!

Do not spray flammable liquids.

If the appliance is used in hazardous areas (e.g. filling stations) the corresponding safety provisions must be observed.

⚠ Danger

Long hours of using the appliance can cause circulation problems in the hands on account of vibrations.

It is not possible to specify a generally valid operation time, since this depends on several factors:

- Proneness to blood circulation deficiencies (cold, numb fingers).
- Low ambient temperature. Wear warm gloves to protect hands.
- A firm grip impedes blood circulation.
- Continuous operation is worse than an operation interrupted by pauses.

In case of regular, long-term operation of the device and in case of repeated occurrence of the symptoms (e.g. cold, numb fingers) please consult a physician.

Caution

Clean engines only at places with corresponding oil separators (environmental safety).

Risk of blocking. Place the nozzles in the accessory compartment with their joint pointing upward.

High pressure operation

Note



The appliance is equipped with a pressure switch. The motor starts up only when the lever of the pistol is pulled.

➔ Set the appliance switch to "I".

➔ Unlock the hand-spray gun and pull the lever of the gun.

Select spray type

- ➔ Close the hand spray gun.
- ➔ Turn the casing of the nozzle till the desired symbol matches the marking.

	High pressure circular spray (0°) for specially stubborn dirt
	Flat low pressure spray (CHEM) for operating using detergents or cleaning at low pressure.
	High pressure flat spray (25°) for large dirt areas

Operation with detergent

⚠ Warning

Unsuitable detergents can cause damage to the appliance and to the object to be cleaned. Use only those detergents that have been approved by Kärcher. Observe the dosage and other instructions provided with these detergents. For considerate treatment of the environment use detergent economically.

Follow the safety instructions for using detergents.

Kärcher detergents ensure smooth functioning. Please consult us or ask for our catalogue or our detergent information sheets.

- ➔ Take out detergent suck hose.
- ➔ Suspend end of suction hose in a container filled with detergent.
- ➔ Set nozzle to "CHEM".
- ➔ Set dosing value for detergent to the desired concentration.

Recommended cleaning method

- Spray the detergent sparingly on the dry surface and allow it to react, but not to dry.
- Spray off loosened dirt with the high-pressure ray.
- After operations, dip the filter in clear water. Turn the dosing valve to the highest detergent concentration. Start the appliance and rinse for one minute.

Interrupting operation

- Release the lever of the hand-spray gun; the device will switch off.
- Release again the lever of the hand-spray gun; the device will switch on again.

Turn off the appliance

- Set the appliance switch to "0".
- Disconnect the mains plug from the socket.
- Shut off water supply.
- Activate hand spray gun until device is pressure-less.
- Press the safety lever of the hand-spray gun to secure the lever of the pistol against being released accidentally.

Storing the Appliance

- Insert the hand-spray gun in the holder.
- Wind up the high-pressure hose and hang it over the hose storage.
- Wind the connection cable around the cable holder.
- Fasten the plug with the mounted clip.

Frost protection

⚠ **Warning**

Frost will destroy the not completely water drained device.

Store the appliance in a frost free area.

If you cannot store it in a frost-free place:

- Drain water.
- Pump in conventional frost protection agents through the appliance.

Note

Use normal glycol-based anti-freezing agents for automobiles.

Observe handling instructions of the anti-freeze agent manufacturer.

- Operate device for max. 1 minute until the pump and conduits are empty.

Transport

Caution

Risk of injury and damage! Observe the weight of the appliance when you transport it.

- Pull the device behind you at the handle for transporting it over longer distances.
- Push the handle downward to carry the appliance. To carry, hold the appliance at the handles and not at the pushing handle.
- When transporting in vehicles, secure the appliance according to the guidelines from slipping and tipping over.

Storage

Caution

Risk of injury and damage! Note the weight of the appliance in case of storage.

This appliance must only be stored in interior rooms.

Maintenance and care

⚠ Danger

Risk of injury by inadvertent startup of appliance and electrical shock.

First pull out the plug from the mains before carrying out any tasks on the machine.

Note

Please dispose off used oil only in the collection points provided for them.

Please hand over old oil, if any, only at such places. Polluting the environment with used oil is a punishable offence.

Safety inspection/ maintenance contract

You can sign with your dealer a contract for regular safety inspection or even sign a maintenance contract. Please take advice on this matter.

Before each use

- Check connection cable for damages (risk of electrical shock); get the damaged connection cable replaced immediately by an authorised customer service person/ electrician.
- Check the high pressure hose for damages (risk of bursting). Please arrange for the immediate exchange of a damaged high-pressure hose.
- Check appliance (pump) for leaks. 3 drops per minute are permitted and can come out from the lower side of the appliance. Call Customer Service if there is heavy leakage.

Weekly

- Check oil level Please contact Customer Service immediately if the oil is milky (water in oil).
- Clean the sieve in the water connection.
- Clean filter at the detergent suck hose.

monthly or after 500 operating hours

- Oil change.

Oil change

Note

See "Technical Details" for details of oil quantity and type.

- Unscrew the fastening screws of the device hood; remove the device hood.
- Remove the lid of the oil container.
- Tilt the appliance forward.
- Drain the oil in a collection basin.
- Fill in new oil slowly; air bubbles should go out.
- Attach the lid of the oil container.
- Fasten the device hood.

Troubleshooting

⚠ Danger

Risk of injury by inadvertent startup of appliance and electrical shock.

First pull out the plug from the mains before carrying out any tasks on the machine.

Get the electrical components checked and repaired only by authorised customer service persons.

Contact an authorised customer service person in case of problems not mentioned in this chapter or if you are in doubt or when you have been explicitly asked to do so.

Appliance is not running

- Check connection cable for damages.
- Check the supply voltage.
- Call Customer Service in case of electrical defects.

Pressure does not build up in the appliance

- Set nozzle to "High pressure".
- Clean the nozzle.
- Replace the nozzle.
- Deaerate the appliance (see "Start-up")
- Check water supply level (refer to technical data).
- Clean the sieve in the water connection.
- Check all inlet pipes to the pump.
- Contact Customer Service if needed.

Pump leaky

3 drops per minute are permitted and can come out from the lower side of the appliance. Call Customer Service if there is heavy leakage.

- With stronger leak, have device checked by customer service.

Pump is vibrating

- Check suction pipes for water and detergent and ensure that they are leak-proof.
- Close dosing valve for detergent to operate the machine without detergent.
- Deaerate the appliance (see "Start-up")
- Contact Customer Service if needed.

Detergent is not getting sucked in

- Set nozzle to "CHEM".
- Check/ clean detergent suction hose with filter.
- Open or check/clean detergent dosing valve.
- Contact Customer Service if needed.

Accessories and Spare Parts

- Only use accessories and spare parts which have been approved by the manufacturer. The exclusive use of original accessories and original spare parts ensures that the appliance can be operated safely and trouble free.
- At the end of the operating instructions you will find a selected list of spare parts that are often required.
- For additional information about spare parts, please go to the Service section at www.kaercher.com.

Warranty

The warranty terms published by the relevant sales company are applicable in each country. We will repair potential failures of your appliance within the warranty period free of charge, provided that such failure is caused by faulty material or defects in manufacturing. In the event of a warranty claim please contact your dealer or the nearest authorized Customer Service centre. Please submit the proof of purchase.

Technical specifications

Main Supply		
Voltage	V	120
Current type	Hz	1~ 60
Connected load	A	14
Protection (slow, char. C)	A	15
Type of protection		IPX5
Extension cord 100 ft/30 m	AWG/mm ²	12/2.5
Water connection		
Max. feed temperature	°F (°C)	140/60
Min. feed volume	GPM / l/min	2,5/9.5
Suck height from open container (20 °C)	ft/m	1,6/0.5
Max. feed pressure	PSI (MPa)	145/1
Performance data		
Working pressure	PSI (MPa)	1300/9.0
Max. operating over-pressure	PSI (MPa)	1500/10.3
Nozzle size		036
Flow rate	GPM / l/min	1.8/6.8
Detergent suck in	GPM / l/min	0...0.13 (0...0.5)
Max. recoil force of hand spray gun	N	15
Values determined as per EN 60355-2-79		
Hand-arm vibration value		
Hand spraygun	m/s ²	2,5
Spray lance	m/s ²	1,8
Uncertainty K	m/s ²	0,3
Sound pressure level L _{pA}	dB(A)	74
Uncertainty K _{pA}	dB(A)	2
Sound power level L _{WA} + Uncertainty K _{WA}	dB(A)	89
Fuel		
Amount of oil	l	0,36
Oil grade	--	SAE 15W40
Dimensions and weights		
Length	mm	360
Width	mm	375
Height	mm	925
Weight	kg	22



<http://www.kaercher.com/dealersearch>

