

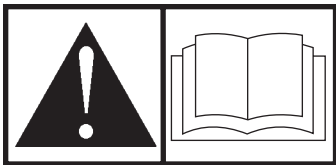

# Pressure Washer Operator's Manual



This pressure washer is rated in accordance to the Pressure Washer Manufacture Association (PWMA) standard PW101 (Testing and Rating Performance of Pressure Washers).

**BRIGGS & STRATTON POWER PRODUCTS GROUP, LLC**  
**JEFFERSON, WISCONSIN, U.S.A.**



Manual No. 203785GS Revision B (09/04/2008)

**Thank you** for purchasing this quality-built Briggs & Stratton pressure washer. We are pleased that you've placed your confidence in the Briggs & Stratton brand. When operated and maintained according to the instructions in this manual, your Briggs & Stratton pressure washer will provide many years of dependable service.

**This manual contains** safety information to make you aware of the hazards and risks associated with pressure washers and how to avoid them. Because Briggs & Stratton does not necessarily know all the applications this pressure washer could be used for, it is important that you read and understand these instructions thoroughly before attempting to start or operate this equipment. **Save these instructions for future reference.**

**This pressure washer requires final assembly before use.** Refer to the *Assembly* section of this manual for instructions on final assembly procedures. Follow the instructions completely.

### Where to Find Us

You never have to look far to find Briggs & Stratton support and service for your pressure washer. Consult your Yellow Pages. There are over 30,000 Briggs & Stratton authorized service dealers worldwide who provide quality service. You can also contact Briggs & Stratton Customer Service by phone at **(800) 743-4115**, or on the Internet at [BRIGGSandSTRATTON.COM](http://BRIGGSandSTRATTON.COM).

### Pressure Washer

Model Number

--	--	--	--	--	--	--

Revision

--	--

Serial Number

--	--	--	--	--	--	--	--	--	--	--	--	--	--

### Engine

Model Number

--	--	--	--	--	--	--

Type Number

--	--	--	--	--	--	--	--

Code Number

--	--	--	--	--	--	--	--	--	--	--	--	--	--	--	--	--	--

### Date Purchased

--	--	--	--	--	--	--	--

Briggs & Stratton Power Products Group, LLC  
900 North Parkway  
Jefferson, WI 53549

Copyright © 2008 Briggs & Stratton Power Products Group, LLC. All rights reserved. No part of this material may be reproduced or transmitted in any form by any means without the express written permission of Briggs & Stratton Power Products Group, LLC.

# Table of Contents

<b>Operator Safety</b> .....	<b>4</b>
Equipment Description .....	4
Important Safety Information .....	4
<b>Assembly</b> .....	<b>7</b>
Unpack Pressure Washer .....	7
Add Engine Oil .....	7
Add Fuel .....	7
Connect Hose and Water Supply to Pump .....	9
<b>Features and Controls</b> .....	<b>10</b>
<b>Operation</b> .....	<b>11</b>
Pressure Washer Location .....	11
How to Start Your Pressure Washer .....	11
How to Stop Your Pressure Washer .....	13
How to Use the Adjustable Nozzle .....	13
Applying Detergent with the Adjustable Nozzle .....	14
Pressure Washer Rinsing .....	15
Cleaning Detergent Siphoning Tube .....	15
Automatic Cool Down System (Thermal Relief) .....	15
<b>Maintenance</b> .....	<b>16</b>
Maintenance Schedule .....	16
Pressure Washer Maintenance .....	16
Engine Maintenance .....	18
After Each Use .....	20
Winter Storage .....	21
Long Term Storage .....	21
<b>Troubleshooting</b> .....	<b>22</b>
<b>Warranties</b> .....	<b>23</b>
Emissions Control System Warranty .....	23
Pressure Washer Owner Warranty .....	25
<b>Specifications</b> .....	<b>26</b>
Product Specifications .....	26
Common Service Parts .....	26

Safety

Assembly

Controls

Operation

Maintenance

Troubleshooting

Warranty

## Operator Safety

### Equipment Description



**Read this manual carefully and become familiar with your pressure washer. Know its applications, its limitations, and any hazards involved.**

This pressure washer operates at 1,900 PSI (131 BARS) at a flow rate of 2.0 gallons per minute (7.6 l). This high quality residential system features an axial cam pump with stainless steel pistons, automatic cool down system, detergent siphoning system, adjustable spray nozzle, safety goggles, heavy duty 25' (7.6 m) hose, and more.

Every effort has been made to ensure that information in this manual is accurate and current. However, we reserve the right to change, alter, or otherwise improve the product and this document at any time without prior notice.

The Emission Control System for this pressure washer is warranted for standards set by the Environmental Protection Agency and the California Air Resources Board.

## Important Safety Information

### Safety Symbols and Meanings



Toxic Fumes



Kickback



Electrical Shock



Slippery Surface



Fall



Fluid Injection



Fire



Explosion

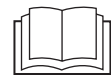

Operator's Manual



Moving Parts



Flying Objects



Hot Surface

**▲** The safety alert symbol indicates a potential personal injury hazard. A signal word (DANGER, WARNING, or CAUTION) is used with the alert symbol to designate a degree or level of hazard seriousness. A safety symbol may be used to represent the type of hazard. The signal word **NOTICE** is used to address practices not related to personal injury.

**▲ DANGER** indicates a hazard which, if not avoided, *will* result in death or serious injury.

**▲ WARNING** indicates a hazard which, if not avoided, *could* result in death or serious injury.

**▲ CAUTION** indicates a hazard which, if not avoided, *could* result in minor or moderate injury.

**NOTICE** address practices not related to personal injury.

**▲ WARNING:** The engine exhaust from this product contains chemicals known to the State of California to cause cancer, birth defects, or other reproductive harm.

**▲ WARNING:** Certain components in this product and related accessories contain chemicals known to the State of California to cause cancer, birth defects or other reproductive harm. Wash hands after handling.

**▲ WARNING:** Running engine gives off carbon monoxide, an odorless, colorless, poison gas. Breathing carbon monoxide can cause headache, fatigue, dizziness, vomiting, confusion, seizures, nausea, fainting or death. Some chemicals or detergents may be harmful if inhaled or ingested, causing severe nausea, fainting, or poisoning.





- Operate pressure washer ONLY outdoors.
- Keep exhaust gas from entering a confined area through windows, doors, ventilation intakes, or other openings.
- DO NOT start or run engine indoors or in an enclosed area, even if windows and doors are open.
- Use a respirator or mask whenever there is a chance that vapors may be inhaled.
- Read all instructions with mask so you are certain the mask will provide the necessary protection against inhaling harmful vapors.

**▲ WARNING:** Risk of electrocution. Contact with power source can cause electric shock or burn.



- NEVER spray near power source.

**▲ WARNING:** Contact with muffler area can result in serious burns. Exhaust heat/gases can ignite combustibles, structures or damage fuel tank causing a fire.





- DO NOT touch hot parts and AVOID hot exhaust gases.
- Allow equipment to cool before touching.
- Keep at least 5 feet (152 cm) of clearance on all sides of pressure washer including overhead.
- It is a violation of California Public Resource Code, Section 4442, to use or operate the engine on any forest-covered, brush-covered, or grass-covered land unless the exhaust system is equipped with a spark arrester, as defined in Section 4442, maintained in effective working order. Other states or federal jurisdictions may have similar laws.

Contact the original equipment manufacturer, retailer, or dealer to obtain a spark arrester designed for the exhaust system installed on this engine.

- Replacement parts must be the same and installed in the same position as the original parts.

**▲ WARNING:** Fuel and its vapors are extremely flammable and explosive. Fire or explosion can cause severe burns or death.



**WHEN ADDING OR DRAINING FUEL**

- Turn pressure washer OFF and let it cool at least 2 minutes before removing fuel cap. Loosen cap slowly to relieve pressure in tank.
- Fill or drain fuel tank outdoors.
- DO NOT overfill tank. Allow space for fuel expansion.
- If fuel spills, wait until it evaporates before starting engine.
- Keep fuel away from sparks, open flames, pilot lights, heat, and other ignition sources.
- DO NOT light a cigarette or smoke.

**WHEN STARTING EQUIPMENT**

- Ensure spark plug, muffler, fuel cap, and air cleaner are in place.
- DO NOT crank engine with spark plug removed.

**WHEN OPERATING EQUIPMENT**

- DO NOT tip engine or equipment at angle which causes fuel to spill.
- DO NOT spray flammable liquids.



**WHEN TRANSPORTING OR REPAIRING EQUIPMENT**

- Transport/repair with fuel tank EMPTY or with fuel shutoff valve OFF.
- Disconnect spark plug wire.

**WHEN STORING FUEL OR EQUIPMENT WITH FUEL IN TANK**

- Store away from furnaces, stoves, water heaters, clothes dryers, or other appliances that have pilot light or other ignition source because they can ignite fuel vapors.

**▲ WARNING:** Use of pressure washer can create puddles and slippery surfaces. Kickback from spray gun can cause you to fall.



- Operate pressure washer from a stable surface.
- The cleaning area should have adequate slopes and drainage to reduce the possibility of a fall due to slippery surfaces.
- Be extremely careful if you must use the pressure washer from a ladder, scaffolding, or any other similar location.
- Firmly grasp spray gun with both hands when using high pressure spray to avoid injury when spray gun kicks back.

**▲ WARNING:** Starter cord kickback (rapid retraction) can result in bodily injury. Kickback will pull hand and arm toward engine faster than you can let go. Broken bones, fractures, bruises, or sprains could result.



- NEVER pull starter cord without first relieving spray gun pressure.
- When starting engine, pull cord slowly until resistance is felt and then pull rapidly to avoid kickback.
- After each starting attempt, where engine fails to run, always point spray gun in safe direction and squeeze spray gun trigger to release high pressure. Engage spray gun trigger lock.
- Firmly grasp spray gun with both hands when using high pressure spray to avoid injury when spray gun kicks back.

**▲ WARNING:** The high pressure stream of water that this equipment produces can cut through skin and its underlying tissues, leading to serious injury and possible amputation.



Spray gun traps high water pressure, even when engine is stopped and water is disconnected, which can cause injury.

- DO NOT allow CHILDREN to operate pressure washer.
- NEVER repair high pressure hose. Replace it.
- NEVER repair leaking connections with sealant of any kind. Replace o-ring or seal.
- NEVER connect high pressure hose to nozzle extension.
- Keep high pressure hose connected to pump and spray gun while system is pressurized.
- ALWAYS point spray gun in safe direction and squeeze spray gun trigger, to release high pressure, every time you stop engine. Engage trigger lock when not in use.
- NEVER aim spray gun at people, animals, or plants.
- DO NOT secure spray gun in open position.
- DO NOT leave spray gun unattended while machine is running.
- NEVER use a spray gun which does not have a trigger lock or trigger guard in place and in working order.
- Always be certain spray gun, nozzles and accessories are correctly attached.

**▲ WARNING:** Unintentional sparking can result in fire or electric shock.



#### WHEN ADJUSTING OR MAKING REPAIRS TO YOUR PRESSURE WASHER

- Disconnect the spark plug wire from the spark plug and place the wire where it cannot contact spark plug.

#### WHEN TESTING FOR ENGINE SPARK

- Use approved spark plug tester.
- DO NOT check for spark with spark plug removed.

**▲ WARNING:** Starter and other rotating parts can entangle hands, hair, clothing, or accessories.



- NEVER operate pressure washer without protective housing or covers.
- DO NOT wear loose clothing, jewelry or anything that may be caught in the starter or other rotating parts.
- Tie up long hair and remove jewelry.

**▲ WARNING:** Risk of eye injury.  
Spray can splash back or propel objects.



- Always wear safety goggles when using this equipment or in vicinity of where equipment is in use.
- Before starting the pressure washer, be sure you are wearing adequate safety goggles.
- NEVER substitute safety glasses for safety goggles.

**NOTICE:** High pressure spray may damage fragile items including glass.

- DO NOT point spray gun at glass when in jet spray mode.
- NEVER aim spray gun at plants.

**NOTICE:** Improper treatment of pressure washer can damage it and shorten its life.

- If you have questions about intended use, ask dealer or contact qualified service center.
- NEVER operate units with broken or missing parts, or without protective housing or covers.
- DO NOT by-pass any safety device on this machine.
- DO NOT tamper with governed speed.
- DO NOT operate pressure washer above rated pressure.
- DO NOT modify pressure washer in any way.
- Before starting pressure washer in cold weather, check all parts of the equipment to be sure ice has not formed there.
- NEVER move machine by pulling on hoses. Use handle provided on unit.
- Check fuel system for leaks or signs of deterioration, such as chafed or spongy hose, loose or missing clamps, or damaged tank or cap. Correct all defects before operating pressure washer.
- This equipment is designed to be used with Briggs & Stratton Power Products authorized parts **ONLY**. If equipment is used with parts that DO NOT comply with minimum specifications, user assumes all risks and liabilities.

## Assembly



**Read entire operator's manual before you attempt to assemble or operate your new pressure washer.**

Your pressure washer requires some assembly and is ready for use after it has been properly serviced with the recommended oil and fuel.

If you have any problems with the assembly of your pressure washer, please call the pressure washer helpline at **(800) 743-4115**. If calling for assistance, please have the model, revision, and serial number from the identification label available.

### Unpack Pressure Washer

1. Remove the parts bag, accessories, and inserts included with pressure washer.
2. Open carton completely by cutting each corner from top to bottom.
3. Ensure you have all included items prior to assembly.

#### Items in the carton include:

- Main Unit
- High Pressure Hose
- Spray Gun
- Adjustable Nozzle Extension
- Safety Goggles
- Oil Bottle
- Parts Bag (which includes the following):
  - Operator's Manual
  - Owner's Registration Card

**To prepare your pressure washer for operation, you will need to perform these tasks:**

1. Fill out and send in registration card.
2. Add oil to engine crankcase.
3. Add fuel to fuel tank.
4. Connect high pressure hose to spray gun and pump.
5. Connect water supply to pump.
6. Attach nozzle extension to spray gun.

### Add Engine Oil

1. Place pressure washer on a flat, level surface.
2. Clean area around oil fill and remove yellow oil fill cap/dipstick.
3. Using oil funnel (optional), slowly pour contents of provided oil bottle into oil fill opening.

**NOTICE:** Improper treatment of pressure washer can damage it and shorten its life.

- DO NOT attempt to crank or start the engine before it has been properly serviced with the recommended oil. This may result in an engine failure.

4. Replace oil fill cap/dipstick and fully tighten.

### Add Fuel

**Fuel must meet these requirements:**

- Clean, fresh, unleaded gasoline.
- A minimum of 87 octane/87 AKI (91 RON). High altitude use, see *High Altitude*.
- Gasoline with up to 10% ethanol (gasohol) or up to 15% MTBE (methyl tertiary butyl ether) is acceptable.

**NOTICE:** Avoid pressure washer damage. Failure to follow Operator's Manual for fuel recommendations voids warranty.

- DO NOT use unapproved gasoline such as E85.
- DO NOT mix oil in gasoline.
- DO NOT modify engine to run on alternate fuels.

To protect the fuel system from gum formation, mix in a fuel stabilizer when adding fuel. See *Storage*. All fuel is not the same. If you experience starting or performance problems after using fuel, switch to a different fuel provider or change brands. This engine is certified to operate on gasoline. The emission control system for this engine is EM (Engine Modifications).

**▲ WARNING:** Fuel and its vapors are extremely flammable and explosive. Fire or explosion can cause severe burns or death.



**WHEN ADDING FUEL**

- Turn pressure washer OFF and let it cool at least 2 minutes before removing fuel cap. Loosen cap slowly to relieve pressure in tank.
- Fill fuel tank outdoors.
- DO NOT overfill tank. Allow space for fuel expansion.
- If fuel spills, wait until it evaporates before starting engine.
- Keep fuel away from sparks, open flames, pilot lights, heat, and other ignition sources.
- DO NOT light a cigarette or smoke.

1. Clean area around fuel fill cap, remove cap.
2. Slowly add regular unleaded fuel (A) to fuel tank (B). Be careful not to overfill. Allow about 1.5" (4 cm) (C) of tank space for fuel expansion.

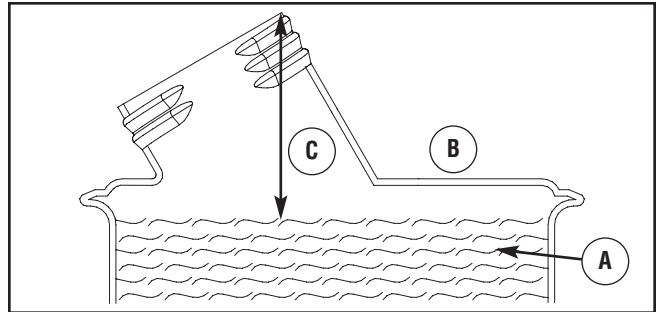

3. Install fuel cap and let any spilled fuel evaporate before starting engine.

**High Altitude**

At altitudes over 5,000 feet (1524 meters), a minimum 85 octane / 85 AKI (89 RON) gasoline is acceptable. To remain emissions compliant, high altitude adjustment is required. Operation without this adjustment will cause decreased performance, increased fuel consumption, and increased emissions. See an Authorized Briggs & Stratton dealer for high altitude adjustment information. Operation of the engine at altitudes below 2,500 feet (762 meters) with the high altitude kit is not recommended.



## Connect Hose and Water Supply to Pump

**NOTICE:** DO NOT run the pump without the water supply connected and turned on.

- Damage to equipment resulting from failure to follow this instruction will void warranty.

**NOTE:** Remove and discard the shipping caps from the pump's high pressure outlet and water inlet before attaching hoses.

1. Uncoil high pressure hose and attach one end of hose to base of spray gun. Tighten by hand.

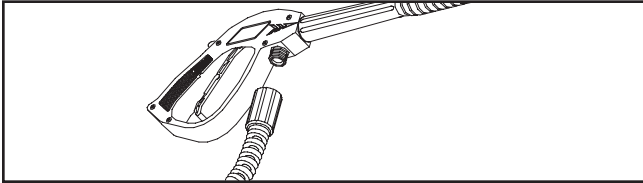

**⚠ WARNING:** The high pressure stream of water that this equipment produces can cut through skin and its underlying tissues, leading to serious injury and possible amputation.

- NEVER connect high pressure hose to nozzle extension.
- Keep high pressure hose connected to pump and spray gun while system is pressurized.
- Always be certain spray gun, nozzles and accessories are correctly attached.

2. Attach other end of high pressure hose to high pressure outlet on pump. Tighten by hand.

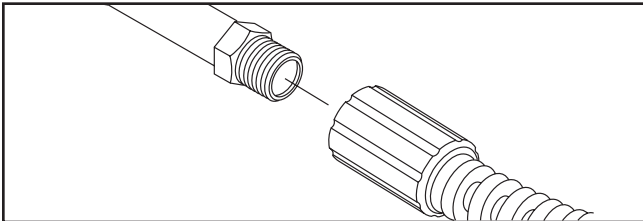

3. Run water through your garden hose for 30 seconds to clean out any debris.

**IMPORTANT:** DO NOT siphon standing water for the water supply. Use ONLY cold water (less than 100°F (38°C)).

4. Before connecting garden hose to water inlet, inspect inlet screen (A). Clean screen if it contains debris or have it replaced if damaged. DO NOT run pressure washer if inlet screen is damaged.

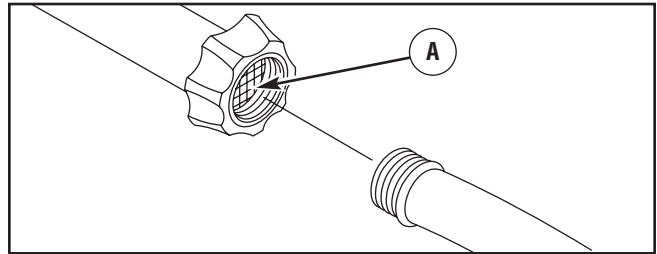

5. Connect the garden hose (not to exceed 50 feet (15 m) in length) to the water inlet. Tighten by hand.

**NOTICE:** Using a One Way Valve (vacuum breaker or check valve) at pump inlet can cause pump or inlet connector damage.

- There MUST be at least ten feet of unrestricted garden hose between the pressure washer inlet and any device, such as a vacuum breaker or check valve.
- Damage to equipment resulting from failure to follow this instruction will void warranty.

6. Turn ON the water and squeeze the trigger on the gun to purge the pump system of air and impurities.

**⚠ WARNING:** Risk of eye injury. Spray can splash back or propel objects.



- Always wear safety goggles when using this equipment or in vicinity of where equipment is in use.
- Before starting the pressure washer, be sure you are wearing adequate safety goggles.
- NEVER substitute safety glasses for safety goggles.

### Checklist Before Starting Engine

Review the unit's assembly to ensure you have performed all of the following.

1. Be sure to read the *Operator Safety* section and *How to Use Your Pressure Washer in Operation* section before using pressure washer.
2. Check that oil has been added to proper level in the engine crankcase.
3. Add proper fuel to fuel tank.
4. Check for properly tightened hose connections.
5. Check to make sure there are no kinks, cuts, or damage to high pressure hose.
6. Provide a proper water supply at an adequate flow.

## Features and Controls



Read this Operator's Manual and safety rules before operating your pressure washer.

Compare the illustrations with your pressure washer, to familiarize yourself with the locations of various controls and adjustments. Save this manual for future reference.

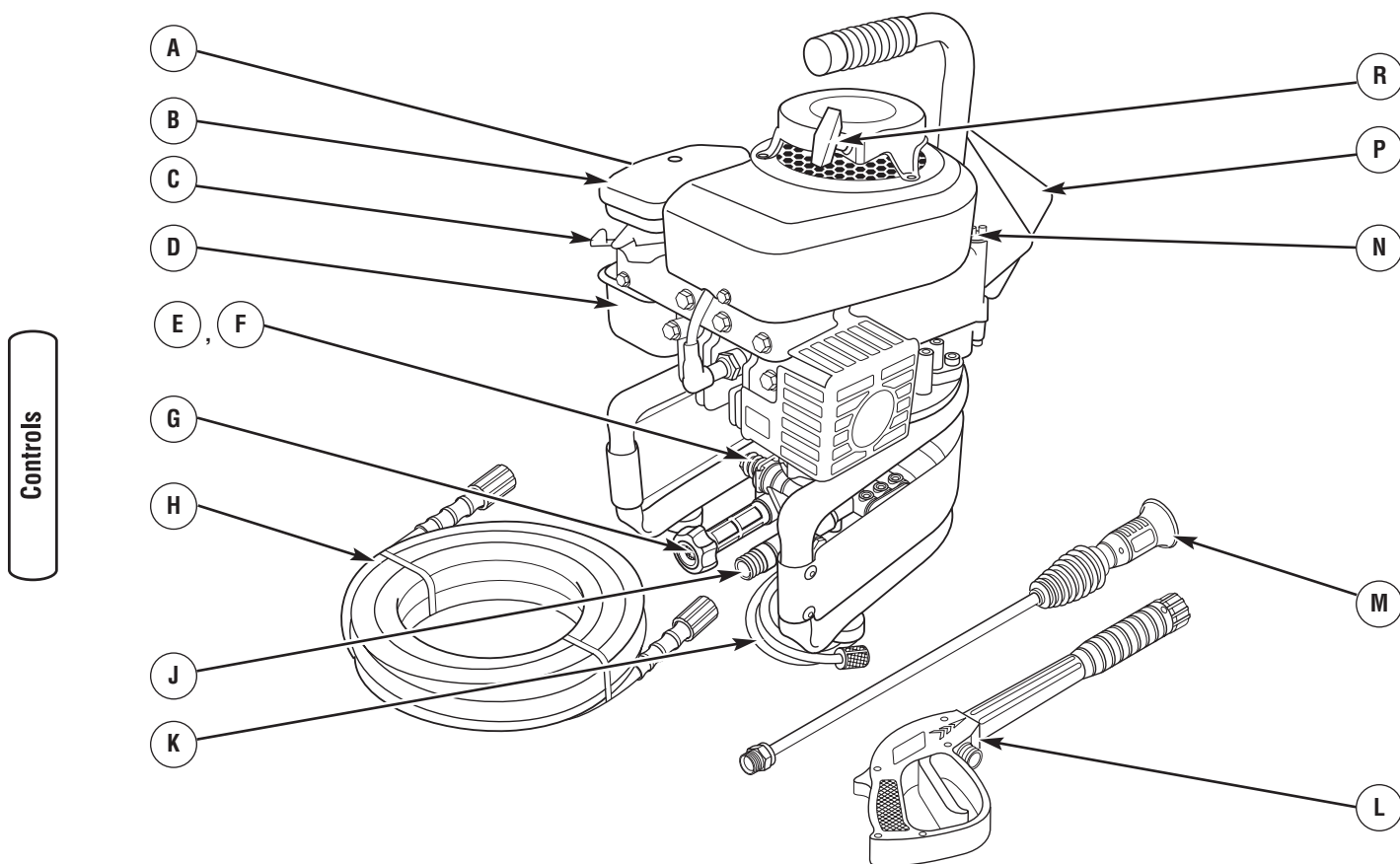

**A - Primer Bulb** — Prepares a cold engine for starting.

**B - Air Filter** — Protects engine by filtering dust and debris out of intake air.

**C - Throttle Lever** — Sets engine in starting mode for recoil starter and stops a running engine.

**D - Fuel Tank** — Fill tank with regular unleaded fuel. Always leave room for fuel expansion.

**E - Pump** — Develops high pressure.

**F - Automatic Cool Down System** — Cycles water through pump when water reaches 125°-155°F (51°-68°C). Warm water will discharge from pump onto ground. This system prevents internal pump damage.

**G - Water Inlet** — Connection for garden hose.

**H - High Pressure Hose** — Connect one end to water pump and the other end to spray gun.

**J - High Pressure Outlet** — Connection for high pressure hose.

**K - Detergent Siphoning Tube/Filter** — Use to siphon pressure washer safe detergents into the low pressure stream.

**L - Spray Gun** — Controls the application of water onto cleaning surface with trigger device. Includes trigger lock.

**M - Adjustable Nozzle** — Always attached to nozzle extension. Adjustable nozzle allows you to adjust spray pressure and spray pattern.

**N - Oil Fill/Dipstick** — Check, fill and drain engine oil here.

**P - Warning/Operating Instructions Tag** — Identifies hazards and proper procedure to start/stop pressure washer.

**R - Recoil Starter** — Used for starting the engine manually.

### Items Not Shown:

**Data Tag (inside base)** — Provides model and serial number of pressure washer. Please have these readily available if calling for assistance.

**Safety Goggles** — Always use the enclosed safety goggles when running your pressure washer.

# Operation

If you have any problems operating your pressure washer, please call the pressure washer helpline at **(800) 743-4115**.

## Pressure Washer Location

### Clearances and Air Movement

**⚠ WARNING:** Exhaust heat/gases can ignite combustibles, structures or damage fuel tank causing a fire.



- Keep at least 5 ft. (152 cm) clearance on all sides of pressure washer including overhead.

Place pressure washer outdoors in an area that will not accumulate deadly exhaust gas. **DO NOT** place pressure washer where exhaust gas **(A)** could accumulate and enter inside or be drawn into a potentially occupied building. Ensure exhaust gas is kept away from any windows, doors, ventilation intakes, or other openings that can allow exhaust gas to collect in a confined area. Prevailing winds and air currents should be taken into consideration when positioning pressure washer.

**⚠ WARNING:** Running engine gives off carbon monoxide, an odorless, colorless, poisonous gas. Breathing carbon monoxide can cause headache, fatigue, dizziness, vomiting, confusion, seizures, nausea, fainting or death.



- Operate pressure washer **ONLY** outdoors.
- Keep exhaust gas from entering a confined area through windows, doors, ventilation intakes, or other openings.
- **DO NOT** start or run engine indoors or in an enclosed area, even if windows and doors are open.

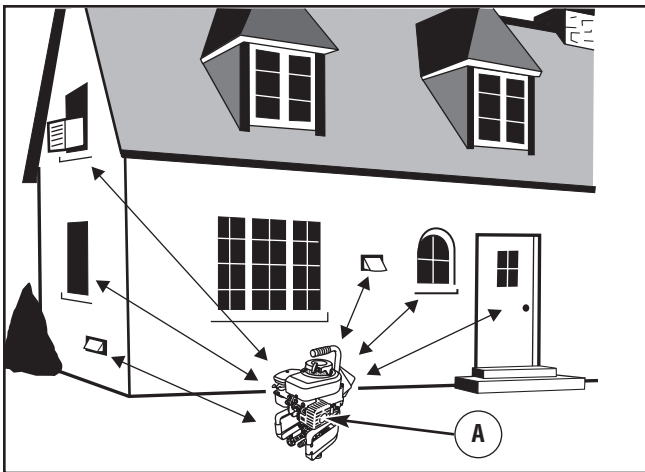

## How to Start Your Pressure Washer

To start your pressure washer for the first time, follow these instructions step-by-step. This starting information also applies if you have let the pressure washer sit idle for at least a day.

1. Place pressure washer near an outside water source capable of supplying water at a flow rate greater than 3.0 gallons (11.4 l) per minute and no less than 20 PSI (1.38 BARS) at pressure washer end of garden hose. **DO NOT** siphon supply water.
2. Check that high pressure hose is tightly connected to spray gun and pump. See *Assembly* section.
3. Make sure unit is in a level position.
4. Connect garden hose to water inlet on pressure washer pump.

**NOTICE:** **DO NOT** run the pump without the water supply connected and turned on.

- Damage to equipment resulting from failure to follow this instruction will void warranty.

5. Turn **ON** water, point gun in a safe direction and squeeze trigger to purge pump system of air and impurities.
6. Attach nozzle extension to spray gun. Tighten by hand.

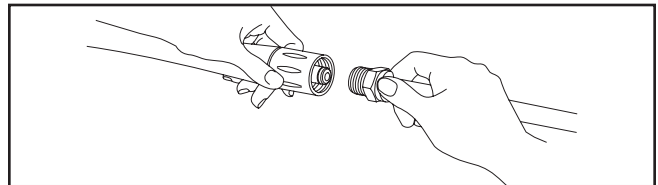

7. Engage trigger lock **(B)** on spray gun trigger.

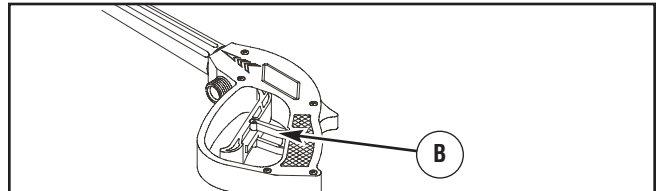

8. Move throttle lever to "**Fast**" position **(C)**, shown as a rabbit.

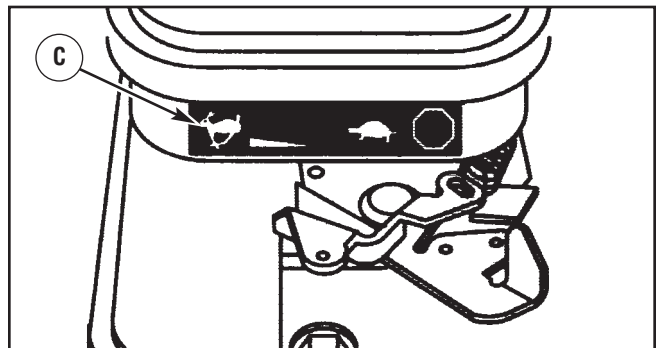

**To start the engine for the very first time:**

- 9A. Push primer bulb firmly 5 times, waiting 2 seconds between each push.

**To start engine thereafter:**

- 9B. Press primer bulb firmly 3 times, waiting 2 seconds between each push. For a warm engine, DO NOT press primer bulb.

**IMPORTANT:** Before starting the pressure washer, be sure you are wearing adequate safety goggles.

**▲ WARNING:** Risk of eye injury.  
Spray can splash back or propel objects.



- Always wear safety goggles when using this equipment or in vicinity of where equipment is in use.
- Before starting the pressure washer, be sure you are wearing adequate safety goggles.
- NEVER substitute safety glasses for safety goggles.

- 10. When starting engine, position yourself as recommended below and grasp starter grip handle and pull slowly until you feel some resistance. Then pull rapidly to start engine.



**▲ WARNING:** Starter cord kickback (rapid retraction) can result in bodily injury. Kickback will pull hand and arm toward engine faster than you can let go. Broken bones, fractures, bruises, or sprains could result.



- NEVER pull starter cord without first relieving spray gun pressure.
- When starting engine, pull cord slowly until resistance is felt and then pull rapidly to avoid kickback.
- After each starting attempt, where engine fails to run, always point spray gun in safe direction and squeeze spray gun trigger to release high pressure. Engage spray gun trigger lock.
- Firmly grasp spray gun with both hands when using high pressure spray to avoid injury when spray gun kicks back.

- 11. Return starter grip handle slowly. DO NOT let rope “snap back” against starter.

**NOTE:** Always keep the throttle lever in the “Fast” position when operating the pressure washer.

**▲ WARNING:** The high pressure stream of water that this equipment produces can cut through skin and its underlying tissues, leading to serious injury and possible amputation.



Spray gun traps high water pressure, even when engine is stopped and water is disconnected, which can cause injury.

- DO NOT allow CHILDREN to operate pressure washer.
- Keep high pressure hose connected to pump and spray gun while system is pressurized.
- NEVER aim spray gun at people, animals, or plants.
- DO NOT secure spray gun in open position.
- DO NOT leave spray gun unattended while machine is running.
- NEVER use a spray gun which does not have a trigger lock or trigger guard in place and in working order.
- Always be certain spray gun, nozzles and accessories are correctly attached.

**▲ WARNING:** Contact with muffler area can result in serious burns.



Exhaust heat/gases can ignite combustibles, structures or damage fuel tank causing a fire.

- DO NOT touch hot parts and AVOID hot exhaust gases.
- Allow equipment to cool before touching.
- Keep at least 5 feet (152 cm) of clearance on all sides of pressure washer including overhead.
- It is a violation of California Public Resource Code, Section 4442, to use or operate the engine on any forest-covered, brush-covered, or grass-covered land unless the exhaust system is equipped with a spark arrester, as defined in Section 4442, maintained in effective working order. Other states or federal jurisdictions may have similar laws.  
Contact the original equipment manufacturer, retailer, or dealer to obtain a spark arrester designed for the exhaust system installed on this engine.
- Replacement parts must be the same and installed in the same position as the original parts.

## How to Stop Your Pressure Washer

1. Release spray gun trigger and let engine idle for two minutes.
2. Move throttle to SLOW position, then STOP position (A).

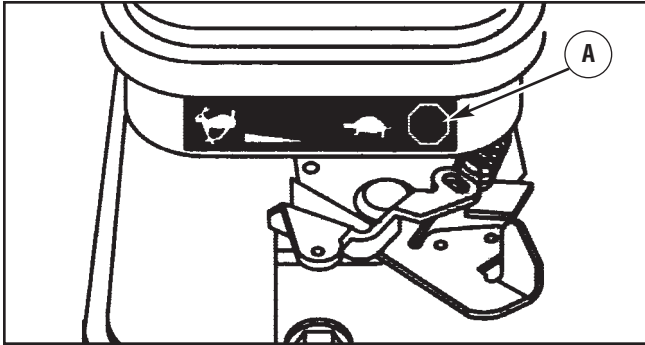

3. ALWAYS point gun in a safe direction and squeeze spray gun trigger to release retained high water pressure.

**IMPORTANT:** Spray gun traps high water pressure, even when engine is stopped and water is disconnected.

**▲ WARNING:** The high pressure stream of water that this equipment produces can cut through skin and its underlying tissues, leading to serious injury and possible amputation.

Spray gun traps high water pressure, even when engine is stopped and water is disconnected, which can cause injury.

- Keep high pressure hose connected to pump and spray gun while system is pressurized.
- ALWAYS point spray gun in safe direction and squeeze spray gun trigger, to release high pressure, every time you stop engine. Engage trigger lock when not in use.

4. Engage trigger lock on spray gun when not in use.

## How to Use the Adjustable Nozzle

You should now know how to **START** and **STOP** your pressure washer. The information in this section will tell you how to adjust the spray pattern and to apply pressure washer specific detergents.

**▲ WARNING:** The high pressure stream of water that this equipment produces can cut through skin and its underlying tissues, leading to serious injury and possible amputation.

- NEVER adjust spray pattern when spraying.
- NEVER put hands in front of nozzle to adjust spray pattern.

1. Slide nozzle backward (B) to achieve high pressure. Slide nozzle forward (C) when you wish to adjust spray to low pressure mode.

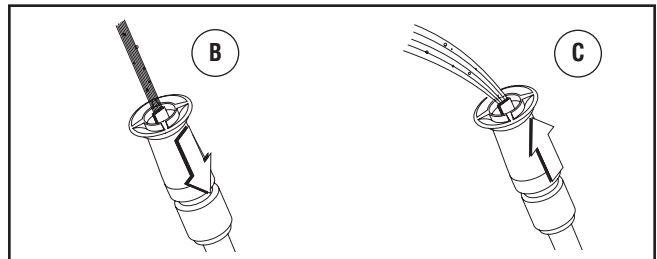

2. Point nozzle down towards a firm surface and press trigger to test pattern.

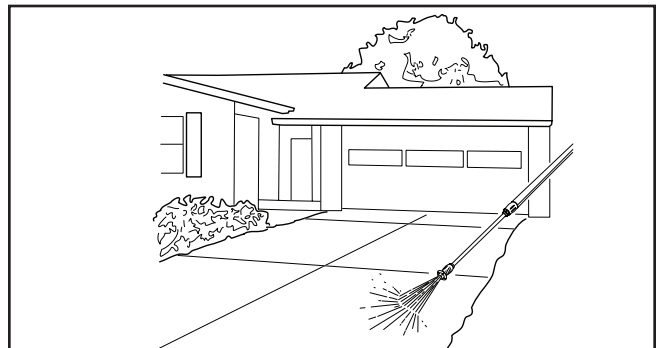

- Twisting nozzle adjusts spray pattern from a fan pattern (A) to a narrow pattern (B).



#### Usage Tips

- For most effective cleaning, keep spray nozzle from 8 to 24 inches (20 to 61 cm) away from cleaning surface.
- If you get spray nozzle too close, especially using high pressure mode, you may damage surface being cleaned.
- DO NOT get closer than 6 inches (15 cm) when cleaning tires.

#### Applying Detergent with the Adjustable Nozzle

**▲ CAUTION:** Chemicals can cause bodily injury, and/or property damage.

- NEVER use caustic liquid with pressure washer.
- Use ONLY pressure washer safe detergents/soaps. Follow all manufacturers instructions.

#### To apply detergent, follow these steps:

- Review use of adjustable nozzles.
- Prepare detergent solution as required by job.

- Place small filter end of detergent siphoning tube into detergent container.

**NOTE:** Make sure the filter is fully submerged in detergent while applying detergent.

**NOTICE:** Contact with the hot muffler can damage detergent siphoning tube.

- When inserting the filter into a detergent solution bottle, route the tube so as to keep it from inadvertently contacting the hot muffler.

- Slide adjustable nozzle forward to low pressure mode. Detergent cannot be applied with nozzle in high pressure position.

- Make sure garden hose is connected to water inlet. Check that high pressure hose is connected to spray gun and pump. Turn on water.

**NOTICE:** You must attach all hoses before you start the engine.

- Starting the engine without all the hoses connected and without the water turned ON will damage the pump.
- Damage to equipment resulting from failure to follow this instruction will void warranty.

- Engage trigger lock on spray gun and start engine following instructions *How to Start Your Pressure Washer*.

- Apply detergent to a dry surface, starting at lower portion of area to be washed and work upward, using long, even, overlapping strokes.

- Allow detergent to "soak in" for 3-5 minutes before washing and rinsing. Reapply as needed to prevent surface from drying. DO NOT allow detergent to dry on (prevents streaking).

**IMPORTANT:** You must flush the detergent siphoning system after each use by placing the filter into a bucket of clean water, then run the pressure washer in low pressure for 1-2 minutes.



## Pressure Washer Rinsing

### For Rinsing:

1. Slide the nozzle backward to high pressure, press the trigger and wait for the detergent to clear.

**NOTE:** You can also stop detergent from flowing by simply removing detergent siphoning tube from bottle.

2. Keep the spray gun a safe distance from the area you plan to spray.

**▲ WARNING:** Kickback from spray gun can cause you to fall.



- Operate pressure washer from a stable surface.
- Be extremely careful if you must use the pressure washer from a ladder, scaffolding, or any other similar location.
- Firmly grasp spray gun with both hands when using high pressure spray to avoid injury when spray gun kicks back.

3. Apply a high pressure spray to a small area, then check the surface for damage. If no damage is found, it is okay to continue cleaning.
4. Start at the top of the area to be rinsed, working down with same overlapping strokes as you used for washing and applying detergent.

## Cleaning Detergent Siphoning Tube

If you used the detergent siphoning tube, you must flush it with clean water before stopping the engine.

1. Place detergent siphoning tube/filter in a bucket full of clean water.
2. Engage trigger lock on spray gun.
3. Slide adjustable nozzle forward to low pressure position.
4. Flush for 1-2 minutes.
5. Shut off engine following instructions *How to Stop Pressure Washer* and turn off water supply.
6. ALWAYS point gun in a safe direction and squeeze spray gun trigger to release retained high water pressure.

**IMPORTANT:** Spray gun traps high water pressure, even when engine is stopped and water is disconnected.

**▲ WARNING:** The high pressure stream of water that this equipment produces can cut through skin and its underlying tissues, leading to serious injury and possible amputation.



Spray gun traps high water pressure, even when engine is stopped and water is disconnected, which can cause injury.

- Keep high pressure hose connected to pump and spray gun while system is pressurized.
- ALWAYS point spray gun in safe direction and squeeze spray gun trigger, to release high pressure, every time you stop engine. Engage trigger lock when not in use.

## Automatic Cool Down System (Thermal Relief)

If you run the engine on your pressure washer for 3-5 minutes without pressing the trigger on the spray gun, circulating water in the pump can reach temperatures above 125°F. The system engages to cool the pump by **discharging the warm water onto the ground.**

# Maintenance

## Maintenance Schedule

Follow the hourly or calendar intervals, whichever occurs first. More frequent service is required when operating in adverse conditions noted below.

<b>First 5 Hours</b>
<ul style="list-style-type: none"><li>• Change engine oil</li></ul>
<b>Every 8 Hours or Daily</b>
<ul style="list-style-type: none"><li>• Check/clean water inlet screen<sup>1</sup></li><li>• Check high pressure hose</li><li>• Check detergent siphoning hose</li><li>• Check spray gun and assembly for leaks</li><li>• Clean debris</li><li>• Check engine oil level</li></ul>
<b>Every 25 Hours or Yearly</b>
<ul style="list-style-type: none"><li>• Service air cleaner<sup>2</sup></li></ul>
<b>Every 50 Hours or Yearly</b>
<ul style="list-style-type: none"><li>• Change engine oil</li><li>• Inspect muffler and spark arrester</li></ul>
<b>Every 100 Hours or Yearly</b>
<ul style="list-style-type: none"><li>• Service spark plug</li><li>• Air cooling system<sup>2</sup></li></ul>

<sup>1</sup> Clean if clogged. Replace if perforated or torn.

<sup>2</sup> Service more often under dirty or dusty conditions.

## General Recommendations

Regular maintenance will improve the performance and extend the life of the pressure washer. See any qualified dealer for service.

The pressure washer's warranty does not cover items that have been subjected to operator abuse or negligence. To receive full value from the warranty, the operator must maintain the pressure washer as instructed in this manual, including proper storage as detailed in *Winter Storage* and *Long Term Storage*.

**NOTE:** Should you have questions about replacing components on your pressure washer, please call **(800) 743-4115** for assistance.

Some adjustments will need to be made periodically to properly maintain your pressure washer.

All service and adjustments should be made at least once each season. Follow the requirements in the Maintenance Schedule chart above.

**NOTE:** Once a year you should clean or replace the spark plug, clean or replace the air filter, and check the spray gun and nozzle extension assembly for wear. A new spark plug and clean air filter assure proper fuel-air mixture and help your engine run better and last longer.

## Pump Oil

DO NOT attempt any oil maintenance on this pump. The pump is pre-lubricated and sealed from the factory, requiring no additional maintenance for the life of the pump.

## Emissions Control

**Maintenance, replacement, or repair of the emissions control devices and systems may be performed by any non-road engine repair establishment or individual.**

However, to obtain "no charge" emissions control service, the work must be performed by a factory authorized dealer. See the *Emissions Warranty*.

## Before Each Use

1. Check engine oil level.
2. Clean debris.
3. Check water inlet screen for damage.
4. Check high pressure hose for leaks.
5. Check detergent siphoning tube and filter for damage.
6. Check spray gun and nozzle extension assembly for leaks.
7. Rinse out garden hose to flush out debris.

## Pressure Washer Maintenance

### Clean Debris

Daily or before use, clean accumulated debris from cleaning system. Keep linkage, spring and controls clean. Keep area around and behind muffler free from any combustible debris. Inspect cooling air slots and openings on the pressure washer. These openings must be kept clean and unobstructed.

Pressure washer parts should be kept clean to reduce the risk of overheating and ignition of accumulated debris.

- Use a damp cloth to wipe exterior surfaces clean.

**NOTICE:** Improper treatment of pressure washer can damage it and shorten its life.

- DO NOT insert any objects through cooling slots.

- Use a soft bristle brush to loosen caked on dirt, oil, etc.
- Use a vacuum cleaner to pick up loose dirt and debris.

### Check and Clean Inlet Screen

Examine the screen on the pump's water inlet. Clean it if the screen is clogged or replace it if screen is damaged.



### Check High Pressure Hose

The high pressure hose can develop leaks from wear, kinking, or abuse. Inspect the hose each time before using it. Check for cuts, leaks, abrasions or bulging of cover, damage or movement of couplings. If any of these conditions exist, replace the hose immediately.

**⚠ WARNING:** The high pressure stream of water that this equipment produces can cut through skin and its underlying tissues, leading to serious injury and possible amputation.

- NEVER repair high pressure hose. Replace it.
- Replacement hose rating MUST exceed maximum pressure rating of unit.

### Check Detergent Siphoning Tube

Examine the filter on the detergent tube and clean if clogged. The tube should fit tightly on the barbed fitting. Examine the tube for leaks or tears. Replace the filter or tube if either is damaged.

### Check Gun and Adjustable Nozzle Extension

Examine the hose connection to the spray gun and make sure it is secure. Test the trigger by pressing it and making sure it “springs back” into place when you release it. Put the trigger lock in the **ON** position and test the trigger. You should not be able to press the trigger.

### Nozzle Maintenance

A pulsing sensation felt while squeezing the spray gun trigger may be caused by excessive pump pressure. The principal cause of excessive pump pressure is a nozzle clogged or restricted with foreign materials, such as dirt, etc. To correct the problem, immediately clean the orifice following these instructions:

1. Shut off engine and turn off water supply.
2. ALWAYS point gun in a safe direction and squeeze spray gun trigger to release retained high water pressure.

**⚠ WARNING:** The high pressure stream of water that this equipment produces can cut through skin and its underlying tissues, leading to serious injury and possible amputation.

Spray gun traps high water pressure, even when engine is stopped and water is disconnected, which can cause injury.

- Keep high pressure hose connected to pump and spray gun while system is pressurized.
- ALWAYS point spray gun in safe direction and squeeze spray gun trigger, to release high pressure, every time you stop engine. Engage trigger lock when not in use.

3. Remove orifice (A) from end of nozzle extension. Separate nozzle extension from spray gun. Twist nozzle clockwise to stream position. Using a 2mm (5/64) allen wrench, remove orifice from end of nozzle extension.

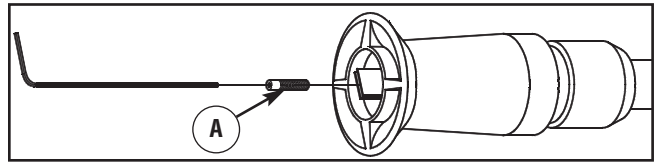

4. Remove nozzle extension from spray gun.
5. Use a small paper clip to free any foreign material clogging or restricting orifice (A).

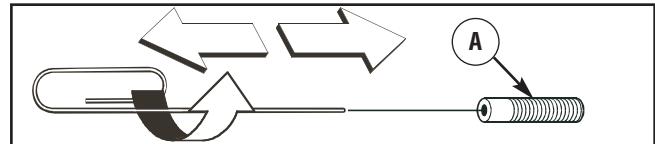

6. Using a garden hose, remove additional debris by back flushing water through nozzle extension. Back flush between 30 to 60 seconds. Turn adjustable nozzle extension to stream spray and move nozzle from low to high while flushing.

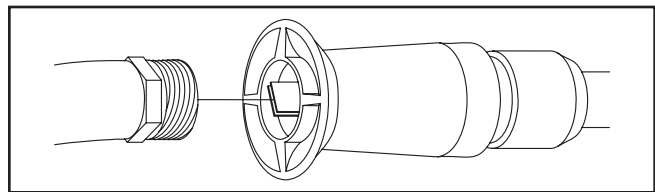

7. Reinstall orifice into nozzle extension. DO NOT overtighten orifice with allen wrench.
8. Reconnect nozzle extension to spray gun.
9. Make sure garden hose is connected to water inlet. Check that high pressure hose is connected to spray gun and pump. Turn on water.
10. Engage trigger lock on spray gun and start engine following instructions *How to Start Your Pressure Washer*.
11. Test pressure washer by operating with nozzle in high and low positions.

### O-Ring Maintenance

Purchase an O-Ring/Maintenance Kit, Model 6048, by contacting the nearest authorized service center. It is not included with the pressure washer. This kit includes replacement o-rings, rubber washer and water inlet filter. Refer to the instruction sheet provided in the kit to service your unit's o-rings.

**⚠ WARNING:** The high pressure stream of water that this equipment produces can cut through skin and its underlying tissues, leading to serious injury and possible amputation.

- NEVER repair leaking connections with sealant of any kind. Replace o-ring or seal.

## Engine Maintenance

**⚠ WARNING:** Unintentional sparking can result in fire or electric shock.



### WHEN ADJUSTING OR MAKING REPAIRS TO YOUR PRESSURE WASHER

- Disconnect the spark plug wire from the spark plug and place the wire where it cannot contact spark plug.

### WHEN TESTING FOR ENGINE SPARK

- Use approved spark plug tester.
- DO NOT check for spark with spark plug removed.

## Oil

### Oil Recommendations

We recommend the use of Briggs & Stratton Warranty Certified oils for best performance. Other high-quality detergent oils are acceptable if classified for service SF, SG, SH, SJ or higher. DO NOT use special additives.

Outdoor temperatures determine the proper oil viscosity for the engine. Use the chart to select the best viscosity for the outdoor temperature range expected.

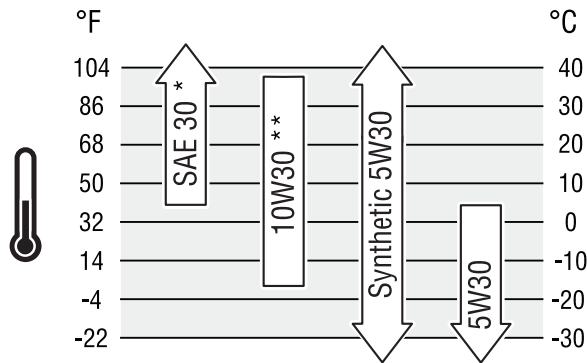

\* Below 40°F (4°C) the use of SAE 30 will result in hard starting.

\*\* Above 80°F (27°C) the use of 10W30 may cause increased oil consumption. Check oil level more frequently.



**NOTE:** Synthetic oil meeting ILSAC GF-2, API certification mark and API service symbol with “SJ/CF ENERGY CONSERVING” or higher, is an acceptable oil at all temperatures. Use of synthetic oil does not alter required oil change intervals.

## Checking Oil Level

Oil level should be checked prior to each use or at least every 8 hours of operation. Keep oil level maintained.

1. Make sure pressure washer is on a level surface.
2. Remove oil dipstick and wipe dipstick with clean cloth. Replace and tighten dipstick. Remove and check oil level.
3. Verify oil is at “Full” mark on dipstick. Replace and tighten dipstick.

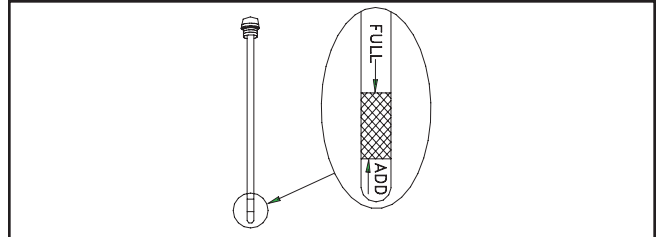

## Adding Engine Oil

1. Make sure pressure washer is on a level surface.
2. Check oil level as described in *Checking Oil Level*.
3. If needed, slowly pour oil into oil fill opening to the “Full” mark on dipstick. DO NOT overfill.

**NOTICE:** Overfilling with oil may cause the engine to not start, or hard starting.

- DO NOT overfill.
- If over the FULL mark on dipstick, drain oil to reduce oil level to FULL mark on dipstick.

4. Replace and tighten dipstick.

## Changing Engine Oil

If you are using your pressure washer under extremely dirty or dusty conditions, or in extremely hot weather, change the oil more often.

**⚠ CAUTION:** Avoid prolonged or repeated skin contact with used motor oil.

- Used motor oil has been shown to cause skin cancer in certain laboratory animals.
- Thoroughly wash exposed areas with soap and water.



KEEP OUT OF REACH OF CHILDREN. DON'T POLLUTE. CONSERVE RESOURCES. RETURN USED OIL TO COLLECTION CENTERS.

**Change oil while engine is still warm from running, as follows:**

1. Drain fuel tank by running pressure washer until fuel tank is empty.
2. Disconnect spark plug wire and keep it away from spark plug.

- Clean area around oil fill, remove oil fill cap/dipstick. Wipe dipstick clean.
- Tip your pressure washer to drain oil from oil fill into a suitable container making sure you tip your unit away from spark plug. When crankcase is empty, return pressure washer to upright position.
- Slowly pour recommended oil (about 20 oz. (0.6 l)) into oil fill opening. Pause to permit oil to settle. Fill to "Full" mark on dipstick.
- Wipe dipstick clean each time oil level is checked. DO NOT overfill.
- Replace and tighten dipstick.
- Wipe up any remaining oil.
- Reconnect spark plug wire to spark plug.

### Service Air Cleaner

Your engine will not run properly and may be damaged if you run it with a dirty air cleaner. Service more often if operating under dirty or dusty conditions.

To service the air cleaner, follow these steps:

- Remove screw (A).

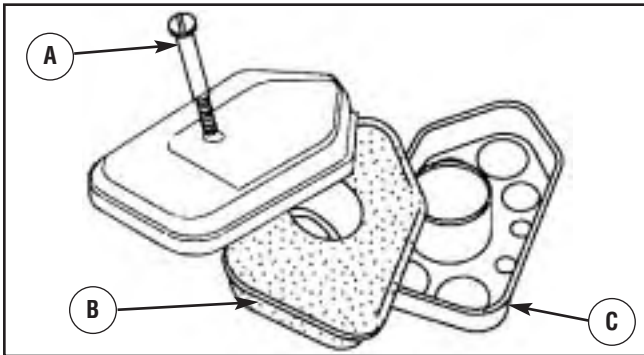

- Carefully remove air cleaner assembly to prevent debris from falling into carburetor.
- Take air cleaner assembly apart and clean all parts. Wash foam air cleaner (B) in liquid detergent and water. Squeeze dry in a clean cloth.
- SATURATE foam air cleaner in engine oil and squeeze in a clean cloth to remove excess oil.
- Reinstall clean or new foam air cleaner in base (C).
- Install air cleaner securely on carburetor with screw.

### Service Spark Plug

Change the spark plug every 100 hours of operation or once each year, whichever comes first. This will help your engine to start easier and run better.

- Clean area around spark plug.
- Remove and inspect spark plug.
- Replace spark plug if electrodes are pitted, burned or porcelain is cracked. Use the recommended replacement plug. See *Specifications*.
- Check electrode gap with wire feeler gauge and reset spark plug gap to recommended gap if necessary (see *Specifications*).

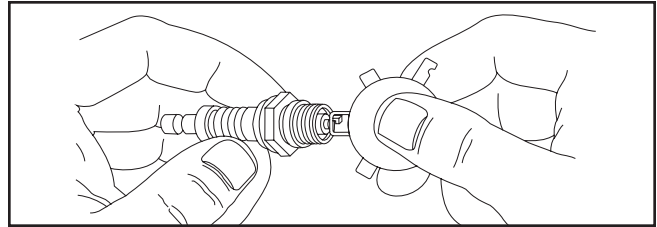

- Install spark plug and tighten firmly.

### Inspect Muffler and Spark Arrester

Inspect the muffler for cracks, corrosion, or other damage. Remove the spark arrester, if equipped, and inspect for damage or carbon blockage. If replacement parts are required, make sure to use only original equipment replacement parts.

**▲ WARNING:** Contact with muffler area can result in serious burns. Exhaust heat/gases can ignite combustibles, structures or damage fuel tank causing a fire.

- DO NOT touch hot parts and AVOID hot exhaust gases.
  - Allow equipment to cool before touching.
  - Keep at least 5 feet (152 cm) of clearance on all sides of pressure washer including overhead.
  - It is a violation of California Public Resource Code, Section 4442, to use or operate the engine on any forest-covered, brush-covered, or grass-covered land unless the exhaust system is equipped with a spark arrester, as defined in Section 4442, maintained in effective working order. Other states or federal jurisdictions may have similar laws.
- Contact the original equipment manufacturer, retailer, or dealer to obtain a spark arrester designed for the exhaust system installed on this engine.
- Replacement parts must be the same and installed in the same position as the original parts.

### Air Cooling System

Over time debris may accumulate in cylinder cooling fins and cannot be observed without partial engine disassembly. For this reason, we recommend you have a qualified service dealer clean the cooling system per recommended intervals (see *Maintenance Schedule* in beginning of *Maintenance* section). Equally important is to keep top of engine free from debris. See *Clean Debris*.

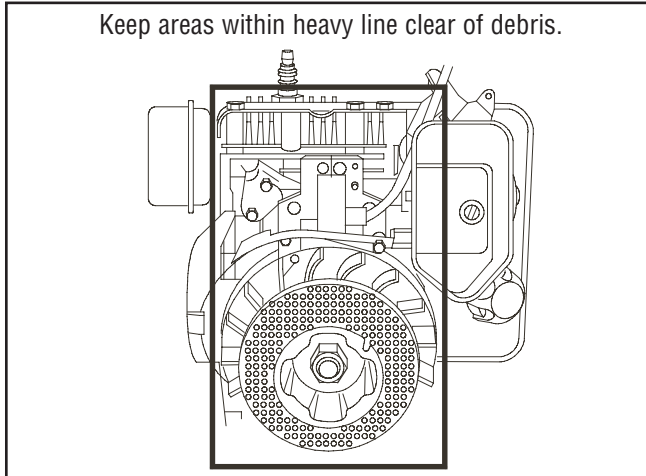

### After Each Use

Water should not remain in the unit for long periods of time. Sediments or minerals can deposit on pump parts and freeze pump action. Follow these procedures after every use:

1. Shut off engine, turn off water supply, point gun in a safe direction and squeeze trigger to relieve trapped pressure, engage trigger lock on spray gun and let engine cool.

**⚠ WARNING:** The high pressure stream of water that this equipment produces can cut through skin and its underlying tissues, leading to serious injury and possible amputation.

 Spray gun traps high water pressure, even when engine is stopped and water is disconnected, which can cause injury.

- Keep high pressure hose connected to pump and spray gun while system is pressurized.
- ALWAYS point spray gun in safe direction and squeeze spray gun trigger, to release high pressure, every time you stop engine. Engage trigger lock when not in use.

2. Disconnect hose from spray gun and high pressure outlet on pump. Drain water from hose, gun, and nozzle extension. Use a rag to wipe off the hose.
3. Empty pump of all pumped liquids by pulling recoil handle about six times. This should remove most liquid in pump.
4. Store unit in a clean, dry area.
5. If storing for more than 30 days, see *Long Term Storage* on next page.

**⚠ WARNING:** Fuel and its vapors are extremely flammable and explosive.

 Fire or explosion can cause severe burns or death.

**WHEN STORING FUEL OR EQUIPMENT WITH FUEL IN TANK**

- Store away from furnaces, stoves, water heaters, clothes dryers, or other appliances that have pilot light or other ignition source because they can ignite fuel vapors.

## Winter Storage

**NOTICE:** You must protect your unit from freezing temperatures.

- Failure to do so will permanently damage your pump and render your unit inoperable.
- Freeze damage is not covered under warranty.

### To protect the unit from freezing temperatures:

1. Follow steps 1-3 in the previous section *After Each Use*.
2. Use pump saver, Model 6039, to treat pump. This minimizes freeze damage and lubricates pistons and seals.
3. If pump saver is not available, connect a 3 ft. (92 cm) section of garden hose to water inlet adapter. Pour RV-antifreeze (antifreeze without alcohol) into hose. Pull recoil handle twice. Disconnect 3 ft. (92 cm) hose.
4. Store unit in a clean, dry area.

## Long Term Storage

If you do not plan to use the pressure washer for more than 30 days, you must prepare the engine and pump for long term storage.

### Protect Fuel System

#### *Fuel Additive:*

Fuel can become stale when stored over 30 days. Stale fuel causes acid and gum deposits to form in the fuel system or on essential carburetor parts. To keep fuel fresh, use Briggs & Stratton FRESH START® fuel stabilizer, available as a liquid additive or a drip concentrate cartridge.

There is no need to drain gasoline from the engine if a fuel stabilizer is added according to instructions. Run the engine for 2 minutes to circulate the stabilizer throughout the fuel system. The engine and fuel can then be stored up to 24 months.

If gasoline in the engine has not been treated with a fuel stabilizer, it must be drained into an approved container. Run the engine until it stops from lack of fuel. The use of a fuel stabilizer in the storage container is recommended to maintain freshness.

## Change Oil

While engine is still warm, drain oil from crankcase. Refill with recommended grade. See *Changing Engine Oil* in *Engine Maintenance*.

### Protecting the Pump

To protect the pump from damage caused by mineral deposits or freezing, use PumpSaver, Model 6039, to treat pump. This prevents freeze damage and lubricates pistons and seals.

**NOTE:** PumpSaver is available as an optional accessory. It is not included with the pressure washer. Contact the nearest authorized service center to purchase PumpSaver.

**NOTICE:** You must protect your unit from freezing temperatures.

- Failure to do so will permanently damage your pump and render your unit inoperable.
- Freeze damage is not covered under warranty.

To use PumpSaver, make sure the pressure washer is turned off and disconnected from supply water. Read and follow all instructions and warnings given on the PumpSaver container.

### Other Storage Tips

1. DO NOT store fuel from one season to another unless it has been treated as described in *Protect Fuel System*.
2. Replace fuel container if it starts to rust. Rust and/or dirt in fuel can cause problems if it's used with this unit.
3. Cover unit with a suitable protective cover that does not retain moisture.

**▲ WARNING:** Storage covers can be flammable.



- DO NOT place a storage cover over a hot pressure washer.
- Let equipment cool for a sufficient time before placing the cover on the equipment.

4. Store unit in a clean and dry area.

# Troubleshooting

Problem	Cause	Correction
<b>Pump has following problems: failure to produce pressure, erratic pressure, chattering, loss of pressure, low water volume.</b>	<ol style="list-style-type: none"> <li>1. Nozzle in low pressure mode.</li> <li>2. Water inlet is blocked.</li> <li>3. Inadequate water supply.</li> <li>4. Inlet hose is kinked or leaking.</li> <li>5. Clogged inlet hose screen.</li> <li>6. Water supply is over 100°F (38°C).</li> <li>7. High pressure hose is blocked or leaks.</li> <li>8. Gun leaks.</li> <li>9. Orifice is obstructed.</li> <li>10. Pump is faulty.</li> </ol>	<ol style="list-style-type: none"> <li>1. Pull nozzle backward for high pressure mode.</li> <li>2. Clear inlet.</li> <li>3. Provide adequate water flow.</li> <li>4. Straighten inlet hose, patch leak.</li> <li>5. Check and clean inlet hose screen.</li> <li>6. Provide cooler water supply.</li> <li>7. Clear blocks in outlet hose.</li> <li>8. Replace gun.</li> <li>9. Clean orifice.</li> <li>10. Contact local service facility.</li> </ol>
<b>Detergent fails to mix with spray.</b>	<ol style="list-style-type: none"> <li>1. Detergent siphoning tube is not submerged.</li> <li>2. Detergent siphoning tube/filter is clogged or cracked.</li> <li>3. Nozzle is in high pressure mode.</li> </ol>	<ol style="list-style-type: none"> <li>1. Insert detergent siphoning tube into detergent.</li> <li>2. Clean or replace filter/detergent siphoning tube.</li> <li>3. Push nozzle forward for low pressure mode.</li> </ol>
<b>Engine runs good at no-load but "bogs" when load is added.</b>	Engine speed is too slow.	Move throttle control to FAST position. If engine still "bogs down", contact local service facility.
<b>Engine will not start; or starts and runs rough.</b>	<ol style="list-style-type: none"> <li>1. Low oil level.</li> <li>2. Dirty air cleaner.</li> <li>3. Out of fuel.</li> <li>4. Stale fuel.</li> <li>5. Spark plug wire not connected to spark plug.</li> <li>6. Bad spark plug.</li> <li>7. Water in fuel.</li> <li>8. Excessively rich fuel mixture.</li> </ol>	<ol style="list-style-type: none"> <li>1. Fill crankcase to proper level.</li> <li>2. Clean or replace air cleaner.</li> <li>3. Fill fuel tank.</li> <li>4. Drain fuel tank; fill with fresh fuel.</li> <li>5. Connect wire to spark plug.</li> <li>6. Replace spark plug.</li> <li>7. Drain fuel tank; fill with fresh fuel.</li> <li>8. Contact local service facility.</li> </ol>
<b>Engine shuts down during operation.</b>	Out of fuel.	Fill fuel tank.
<b>Engine lacks power.</b>	Dirty air filter.	Replace air filter.



# Warranties

## Emissions Control System Warranty

**Briggs & Stratton Corporation (B&S), the California Air Resources Board (CARB) and the United States Environmental Protection Agency (U.S. EPA)**

**Emissions Control System Warranty Statement (Owner's Defect Warranty Rights and Obligations)**

### California, United States and Canada Emissions Control Defects Warranty Statement

The California Air Resources Board (CARB), U.S. EPA and B&S are pleased to explain the Emissions Control System Warranty on your small off-road engine (SORE). In California, new small off-road engines model year 2006 and later must be designed, built and equipped to meet the State's stringent anti-smog standards. Elsewhere in the United States, new non-road, spark-ignition engines certified for model year 1997 and later must meet similar standards set forth by the U.S. EPA. B&S must warrant the emissions control system on your engine for the periods of time listed below, provided there has been no abuse, neglect or improper maintenance of your small off-road engine.

Your emissions control system includes parts such as the carburetor, air cleaner, ignition system, fuel line, muffler and catalytic converter. Also included may be connectors and other emissions related assemblies.

Where a warrantable condition exists, B&S will repair your small off-road engine at no cost to you including diagnosis, parts and labor.

### Briggs & Stratton Emissions Control Defects Warranty Coverage

Small off-road engines are warranted relative to emissions control parts defects for a period of two years, subject to provisions set forth below. If any covered part on your engine is defective, the part will be repaired or replaced by B&S.

### Owner's Warranty Responsibilities

As the small off-road engine owner, you are responsible for the performance of the required maintenance listed in your Operating and Maintenance Instructions. B&S recommends that you retain all your receipts covering maintenance on your small off-road engine, but B&S cannot deny warranty solely for the lack of receipts or for your failure to ensure the performance of all scheduled maintenance.

As the small off-road engine owner, you should however be aware that B&S may deny you warranty coverage if your small off-road engine or a part has failed due to abuse, neglect, improper maintenance or unapproved modifications.

You are responsible for presenting your small off-road engine to an Authorized B&S Service Dealer as soon as a problem exists. The undisputed warranty repairs should be completed in a reasonable amount of time, not to exceed 30 days.

If you have any questions regarding your warranty rights and responsibilities, you should contact a B&S Service Representative at (414) 259-5262.

The emissions warranty is a defects warranty. Defects are judged on normal engine performance. The warranty is not related to an in-use emissions test.

### Briggs & Stratton Emissions Control Defects Warranty Provisions

The following are specific provisions relative to your Emissions Control Defects Warranty Coverage. It is in addition to the B&S engine warranty for non-regulated engines found in the Operator's Manual.

#### 1. Warranted Parts

Coverage under this warranty extends only to the parts listed below (the emissions control systems parts) to the extent these parts were present on the engine purchased.

##### a. Fuel Metering System

- Cold start enrichment system (soft choke)
- Carburetor and internal parts
- Fuel Pump
- Fuel line, fuel line fittings, clamps
- Fuel tank, cap and tether
- Carbon canister

##### b. Air Induction System

- Air cleaner
- Intake manifold
- Purge and vent line

##### c. Ignition System

- Spark plug(s)
- Magneto ignition system

##### d. Catalyst System

- Catalytic converter
- Exhaust manifold
- Air injection system or pulse valve

##### e. Miscellaneous Items Used in Above Systems

- Vacuum, temperature, position, time sensitive valves and switches
- Connectors and assemblies

## 2. Length of Coverage

B&S warrants to the initial owner and each subsequent purchaser that the Warranted Parts shall be free from defects in materials and workmanship which caused the failure of the Warranted Parts for a period of two years from the date the engine is delivered to a retail purchaser.

## 3. No Charge

Repair or replacement of any Warranted Part will be performed at no charge to the owner, including diagnostic labor which leads to the determination that a Warranted Part is defective, if the diagnostic work is performed at an Authorized B&S Service Dealer. For emissions warranty service contact your nearest Authorized B&S Service Dealer as listed in the "Yellow Pages" under "Engines, Gasoline," "Gasoline Engines," "Lawn Mowers," or similar category.

## 4. Claims and Coverage Exclusions

Warranty claims shall be filed in accordance with the provisions of the B&S Engine Warranty Policy. Warranty coverage shall be excluded for failures of Warranted Parts which are not original B&S parts or because of abuse, neglect or improper maintenance as set forth in the B&S Engine Warranty Policy. B&S is not liable to cover failures of Warranted Parts caused by the use of add-on, non-original, or modified parts.

## 5. Maintenance

Any Warranted Part which is not scheduled for replacement as required maintenance or which is scheduled only for regular inspection to the effect of "repair or replace as necessary" shall be warranted as to defects for the warranty period. Any Warranted Part which is scheduled for replacement as required maintenance shall be warranted as to defects only for the period of time up to the first scheduled replacement for that part. Any replacement part that is equivalent in performance and durability may be used in the performance of any maintenance or repairs. The owner is responsible for the performance of all required maintenance, as defined in the B&S Operator's Manual.

## 6. Consequential Coverage

Coverage hereunder shall extend to the failure of any engine components caused by the failure of any Warranted Part still under warranty.

## Emission Information

Engines that are certified to meet the California Air Resources Board (CARB) Emission Standards must display information regarding the Emissions Durability Period and Air Index. The engine manufacturer makes this information available to the consumer on emission labels. The engine emission label will indicate certification information.

The **Emissions Durability Period** describes the number of hours of actual running time for which the engine is certified to be emissions compliant, assuming proper maintenance in accordance with the Operating & Maintenance Instructions. The following categories are used:

**Moderate:** Engine is certified to be emission compliant for 125 hours of actual engine running time.

**Intermediate:** Engine is certified to be emission compliant for 250 hours of actual engine running time.

**Extended:** Engine is certified to be emission compliant for 500 hours of actual engine running time.

For example, a typical walk-behind lawn mower is used 20 to 25 hours per year. Therefore, the **Emissions Durability Period** of an engine with an **intermediate** rating would equate to 10 to 12 years.

Certain engines will be certified to meet the United States Environmental Protection Agency (USEPA) Phase 2 emission standards. For phase 2 certified engines, the Emissions Compliance Period referred to on the Emissions Compliance label indicates the number of operating hours for which the engine has been shown to meet Federal emission requirements.

For engines less than 225 cc displacement:

Category C = 125 hours

Category B = 250 hours

Category A = 500 hours.

For engines of 225 cc or more displacement:

Category C = 250 hours

Category B = 500 hours

Category A = 1000 hours.



## BRIGGS & STRATTON POWER PRODUCTS GROUP, LLC PRESSURE WASHER OWNER WARRANTY POLICY

Effective December 1, 2005 replaces all undated Warranties and all Warranties dated before December 1, 2005

### LIMITED WARRANTY

Briggs & Stratton Power Products Group, LLC will repair or replace, free of charge, any part(s) of the pressure washer that is defective in material or workmanship or both. Transportation charges on product submitted for repair or replacement under this warranty must be borne by purchaser. This warranty is effective for the time periods and subject to the conditions stated below. For warranty service, find the nearest Authorized Service Dealer in our dealer locator map at BRIGGSandSTRATTON.COM.

THERE IS NO OTHER EXPRESS WARRANTY. IMPLIED WARRANTIES, INCLUDING THOSE OF MERCHANTABILITY AND FITNESS FOR A PARTICULAR PURPOSE, ARE LIMITED TO ONE YEAR FROM PURCHASE, OR TO THE EXTENT PERMITTED BY LAW. ANY AND ALL IMPLIED WARRANTIES ARE EXCLUDED. LIABILITY FOR INCIDENTAL OR CONSEQUENTIAL DAMAGES ARE EXCLUDED TO THE EXTENT EXCLUSION IS PERMITTED BY LAW. Some states or countries do not allow limitations on how long an implied warranty lasts, and some states or countries do not allow the exclusion or limitation of incidental or consequential damages, so the above limitation and exclusion may not apply to you. This warranty gives you specific legal rights and you may also have other rights which vary from state to state or country to country.

### WARRANTY PERIOD

<b>Consumer Use</b>	<b>1 year</b>
<b>Commercial Use</b>	<b>90 days</b>

The warranty period begins on the date of purchase by the first retail consumer or commercial end user, and continues for the period of time stated above. "Consumer use" means personal residential household use by a retail consumer. "Commercial use" means all other uses, including use for commercial, income producing or rental purposes. Once equipment has experienced commercial use, it shall thereafter be considered as commercial use for purposes of this warranty.

NO WARRANTY REGISTRATION IS NECESSARY TO OBTAIN WARRANTY ON BRIGGS & STRATTON PRODUCTS. SAVE YOUR PROOF OF PURCHASE RECEIPT. IF YOU DO NOT PROVIDE PROOF OF THE INITIAL PURCHASE DATE AT THE TIME WARRANTY SERVICE IS REQUESTED, THE MANUFACTURING DATE OF THE PRODUCT WILL BE USED TO DETERMINE THE WARRANTY PERIOD.

### ABOUT YOUR WARRANTY

We welcome warranty repair and apologize to you for being inconvenienced. Any Authorized Service Dealer may perform warranty repairs. Most warranty repairs are handled routinely, but sometimes requests for warranty service may not be appropriate. For example, warranty service would not apply if equipment damage occurred because of misuse, lack of routine maintenance, shipping, handling, warehousing or improper installation. Similarly, the warranty is void if the manufacturing date or the serial number on the pressure washer or engine has been removed or the equipment has been altered or modified. During the warranty period, the Authorized Service Dealer, at its option, will repair or replace any part that, upon examination, is found to be defective under normal use and service. This warranty will not cover the following repairs and equipment:

- **Normal Wear:** Outdoor Power Equipment, like all mechanical devices, needs periodic parts and service to perform well. This warranty also does not cover normal maintenance such as air filters, adjustments, fuel system cleaning and obstruction (due to chemical, lime, dirt, and so forth).
- **Installation and Maintenance:** This warranty does not apply to equipment or parts that have been subjected to improper or unauthorized installation or alteration and modification, misuse, negligence, accident, overloading, overspeeding, improper maintenance, repair or storage so as, in our judgment, to adversely affect its performance and reliability. This warranty also does not cover normal maintenance such as air filters, adjustments, fuel system cleaning and obstruction (due to chemical, lime, dirt, and so forth).
- **Other Exclusions:** This warranty excludes wear items such as quick couplers, seals, o-rings, pumps that have been run without water supplied or damage or malfunctions resulting from accidents, abuse, modifications, alterations, or improper servicing or freezing or chemical deterioration. Accessory parts, such as guns, hoses, nozzle extensions (wands), and nozzles, are excluded from the product warranty. This warranty excludes used, reconditioned, and demonstration equipment and failures due to acts of God and other force majeure events beyond the manufacturers control.  
198187E, Rev. C, 12/31/2006

**BRIGGS & STRATTON POWER PRODUCTS GROUP, LLC**  
**JEFFERSON, WI, USA**



## Pressure Washer

### Product Specifications

Outlet Pressure	1,900 PSI (131 BARS)
Flow Rate	2.0 GPM (7.6 liters/min)
Water Supply Temperature	100°F (38°C) MAX
Displacement	147.8 cc
Spark Plug Gap	0.030 in. (0.76 mm)
Fuel Capacity	1 Qt. (0.95 Liters)
Oil Capacity	20 Ounces (0.6 Liters)

### Common Service Parts

PumpSaver	.6039
O-Ring Maintenance Kit	.6048
Water Inlet Screen	B2384GS
Air Cleaner	.698369 or 5088
Resistor Spark Plug	.802592 or 5095
Long Life Platinum Spark Plug	.5062
Engine Oil Bottle	.100005
Fuel Stabilizer	.5041
Spark Arrester	.398067

**Power Ratings:** The gross power rating for individual gas engine models is labeled in accordance with SAE (Society of Automotive Engineers) code J1940 (Small Engine Power & Torque Rating Procedure), and rating performance has been obtained and corrected in accordance with SAE J1995 (Revision 2002-05). Torque values are derived at 3060 RPM; horsepower values are derived at 3600 RPM. Actual gross engine power will be lower and is affected by, among other things, ambient operating conditions and engine-to-engine variability. Given both the wide array of products on which engines are placed and the variety of environmental issues applicable to operating the equipment, the gas engine will not develop the rated gross power when used in a given piece of power equipment (actual "on-site" or net power). This difference is due to a variety of factors including, but not limited to, accessories (air cleaner, exhaust, charging, cooling, carburetor, fuel pump, etc.), application limitations, ambient operating conditions (temperature, humidity, altitude), and engine-to-engine variability. Due to manufacturing and capacity limitations, Briggs & Stratton may substitute an engine of higher rated power for this Series engine.

This pressure washer is rated in accordance to the Pressure Washer Manufacture Association (PWMA) standard PW101 (Testing and Rating Performance of Pressure Washers).

Briggs & Stratton Power Products Group, LLC  
900 N. Parkway  
Jefferson, Wisconsin, 53549 U.S.A.